

# *Grizzly* **Industrial, Inc.**®

## MODEL H6329 2½ GALLON PAINT TANK INSTRUCTION MANUAL



COPYRIGHT © MAY, 2009 BY GRIZZLY INDUSTRIAL, INC.  
**WARNING: NO PORTION OF THIS MANUAL MAY BE REPRODUCED IN ANY SHAPE  
OR FORM WITHOUT THE WRITTEN APPROVAL OF GRIZZLY INDUSTRIAL, INC.**  
#CR11799 PRINTED IN CHINA



## **WARNING!**

**This manual provides critical safety instructions on the proper setup, operation, maintenance and service of this machine/equipment.**

**Failure to read, understand and follow the instructions given in this manual may result in serious personal injury, including amputation, electrocution or death.**

**The owner of this machine/equipment is solely responsible for its safe use. This responsibility includes but is not limited to proper installation in a safe environment, personnel training and usage authorization, proper inspection and maintenance, manual availability and comprehension, application of safety devices, blade/cutter integrity, and the usage of personal protective equipment.**

**The manufacturer will not be held liable for injury or property damage from negligence, improper training, machine modifications or misuse.**



## **WARNING!**

**Some dust created by power sanding, sawing, grinding, drilling, and other construction activities contains chemicals known to the State of California to cause cancer, birth defects or other reproductive harm. Some examples of these chemicals are:**

- **Lead from lead-based paints.**
- **Crystalline silica from bricks, cement and other masonry products.**
- **Arsenic and chromium from chemically-treated lumber.**

**Your risk from these exposures varies, depending on how often you do this type of work. To reduce your exposure to these chemicals: Work in a well ventilated area, and work with approved safety equipment, such as those dust masks that are specially designed to filter out microscopic particles.**

# SAFETY

## **WARNING**

### **For Your Own Safety Read Instruction Manual Before Operating This Equipment**

The purpose of safety symbols is to attract your attention to possible hazardous conditions. This manual uses a series of symbols and signal words which are intended to convey the level of importance of the safety messages. The progression of symbols is described below. Remember that safety messages by themselves do not eliminate danger and are not a substitute for proper accident prevention measures.



Indicates an imminently hazardous situation which, if not avoided, **WILL** result in death or serious injury.



Indicates a potentially hazardous situation which, if not avoided, **COULD** result in death or serious injury.



Indicates a potentially hazardous situation which, if not avoided, **MAY** result in minor or moderate injury. It may also be used to alert against unsafe practices.

**NOTICE**

This symbol is used to alert the user to useful information about proper operation of the equipment.

## **WARNING**

### **Safety Instructions for Pneumatic Tools**

- 1. READ THIS MANUAL.** This tool may cause personal injury if used incorrectly. This manual contains proper safety and operating instructions that must be followed to reduce this risk.
- 2. WEAR EYE PROTECTION.** This tool may throw small fragments during operation, which may cause serious eye injury. Always wear ANSI approved safety glasses or face shield to reduce your risk from this hazard.
- 3. WEAR A RESPIRATOR.** This tool may produce fine dust during operation, which can cause respiratory injury if inhaled. Always wear a respirator NIOSH approved for the type of material being processed.
- 4. WEAR HEARING PROTECTION.** Operating this tool for prolonged time periods may damage your hearing. Your risk depends on length and frequency of use. To reduce your risk of this hazard, wear hearing protection.
- 5. MAINTAIN SAFETY GUARDS.** Your tool may be equipped with safety guards or other structural components designed to reduce the risk of injury during operation. Never modify or operate this tool with any guards or components removed or damaged.
- 6. KEEP CHILDREN AWAY.** Prevent children from injury by keeping them away from this tool. Disconnect and lock the tool away when not in use.

# **WARNING**

## **Safety Instructions for Pneumatic Tools**

- 7. AVOID ENTANGLEMENTS.** Do not wear loose clothing, gloves, neckties, rings, bracelets, or other jewelry, which may get caught in moving parts, when operating this tool. Wear a protective hair covering to contain long hair.
- 8. USE CORRECT AIR PRESSURE.** Exceeding the maximum PSI rating of this tool may cause unpredictable operation or bursting.
- 9. DISCONNECT AIR PRESSURE** before servicing, changing accessories, or moving to another location. Never leave this tool unattended when connected to air.
- 10. SECURE TOOLING.** Always verify tooling is secure before operation.
- 11. SHARP SURFACES.** DO NOT place hands near the tooling surfaces when in operation.
- 12. REMOVE ADJUSTING KEYS AND WRENCHES AFTER USE.** These tools become dangerous projectiles if left on the tool when it is started.
- 13. AVOID FLAMMABLES.** Do not use this tool around any flammables that may be ignited by sparks.
- 14. SECURE WORK.** Use clamps or a vise to hold work when practical. It is safer than using your hand and frees both hands to operate tool.
- 15. MAINTAIN TOOLS WITH CARE.** Keep tools lubricated and clean for best and safest performance. Follow instructions for lubricating and changing accessories.
- 16. DO NOT FORCE TOOL.** It will do the job better and safer at the rate for which it was designed.
- 17. CHECK FOR DAMAGED PARTS BEFORE USING.** Check for binding and alignment of parts, broken parts, part mounting, loose bolts, and any other conditions that may affect operation. Repair or replace damaged parts before operating.
- 18. USE GOOD LIGHTING.** Keep work area well lighted. Dark work areas increase risk of accidental injury.
- 19. AVOID UNINTENTIONAL OPERATION.** Always disconnect air when not in use, and do not carry tool with hand on trigger.
- 20. USE THE RECOMMENDED ACCESSORIES.** Consult owner's manual for recommended accessories. Using improper accessories may increase the risk of injury.
- 21. NEVER ALLOW UNTRAINED USERS TO USE THIS TOOL WHILE UNSUPERVISED.**
- 22. IF YOU ARE UNSURE OF THE INTENDED OPERATION, STOP USING TOOL.** Seek formal training or research books or magazines that specialize in pneumatic tools.
- 23. BE AWARE OF HOSE LOCATION.** Hoses can easily become a tripping hazard when laid across the floor in a disorganized fashion.
- 24. DO NOT USE UNDER THE INFLUENCE OF DRUGS OR ALCOHOL, OR WHEN TIRED.**

# WARNING

## Additional Safety Instructions for Paint Tanks

- 1. READ THIS MANUAL.** This manual contains proper operating instructions for using this paint tank.
- 2. DESIGN MODIFICATIONS.** Do not modify the tank design or construction. Drilling into the tank or welding on attachments, or altering its design, will weaken the tank.
- 3. CLEANING AND MAINTENANCE.** Clean and dry the tank and lid according to the instructions in this manual. Make sure all ports are free of hardened paint or other materials that could prevent free movement of air. Improper cleaning could allow pressure to rise to dangerous levels.
- 4. REACTIVE CHEMICALS.** Do not use acids, caustic solutions, or halogenated hydrocarbon solvents. These chemicals can attack the lid gasket and safety valve seal, compromising the ability of the tank to hold pressure.
- 5. SAFETY VALVE MODIFICATIONS.** Never adjust the safety valve to change its pressure setting or defeat its function. Tampering with the safety valve could allow tank pressure to rise to dangerous levels.
- 6. REMOVING LID.** Do not try to remove the lid while the tank is under pressure, or you could cause an explosion. Follow the instructions in this manual for relieving pressure in the tank before removing the lid.
- 7. LID CLAMPS.** Overtightening the lid clamps could cause them to weaken and fail, resulting in the lid being propelled violently from the tank. Only tighten the clamps by hand. Do not use tools to tighten them.
- 8. NON-STANDARD COMPONENTS.** Substituting non-standard components could weaken the tank or cause component failure. Only use components provided with your tank.
- 9. ATTACHMENTS.** Make sure equipment connected to the tank has a higher pressure rating than the regulated air pressure in the tank. Attachments with a pressure rating lower than the adjusted tank pressure could explode, resulting in serious personal injury.

# CAUTION

No list of safety guidelines is complete, because every work environment is different. Always consider safety first and use common sense. Failure to use this tool with caution and respect could result in serious personal injury.

# INTRODUCTION

---

---

## Foreword

---

---

The specifications, details, and photographs in this manual represent the Model H6329 as supplied when the manual was prepared. However, owing to Grizzly's policy of continuous improvement, changes may be made at any time with no obligation on the part of Grizzly.

If you have any comments regarding this manual, please contact us:

Grizzly Industrial, Inc.  
C/O Technical Documentation Manager  
P.O. Box 2069  
Bellingham, WA 98227-2069  
Email: [manuals@grizzly.com](mailto:manuals@grizzly.com)

Most importantly, we stand behind our tools. If you have any service questions or parts requests, please call or write us at the location listed below.

Grizzly Industrial, Inc.  
1203 Lycoming Mall Circle  
Muncy, PA 17756  
Phone: (570) 546-9663  
Fax: (800) 438-5901  
E-Mail: [techsupport@grizzly.com](mailto:techsupport@grizzly.com)  
Web Site: <http://www.grizzly.com>

## Specifications

---

---

### Paint Tank

Material Capacity .....2½ Gallons (10 L)  
Operating Pressure .....10–45 PSI  
Maximum Operating Pressure.....45 PSI  
Tank Construction .....Teflon Coated Steel

# SETUP

## Unpacking

Your paint tank was carefully packaged for safe shipping. If you discover any damage after you have signed for delivery, *immediately call Customer Service at (570) 546-9663 for advice.*

Save the containers and all packing materials for possible inspection by the carrier or its agent. *Otherwise, filing a freight claim can be difficult.*

When you are completely satisfied with the condition of the shipment, you should inventory the contents.

## Inventory

H6329 Inventory (Figure 1)	Qty
A. Paint Tank	1
B. Caster Wheel Assemblies	4
—Hex Nuts M8-1.25	4
—Flat Washers 8MM	4
—Lock Washers 8MM	4
C. Push-On Hose Fittings (1/4")	2
D. Crank Handle Assembly	1
E. Mixing Propeller	1



Figure 1. Model H6329 Inventory.

# Tank Assembly

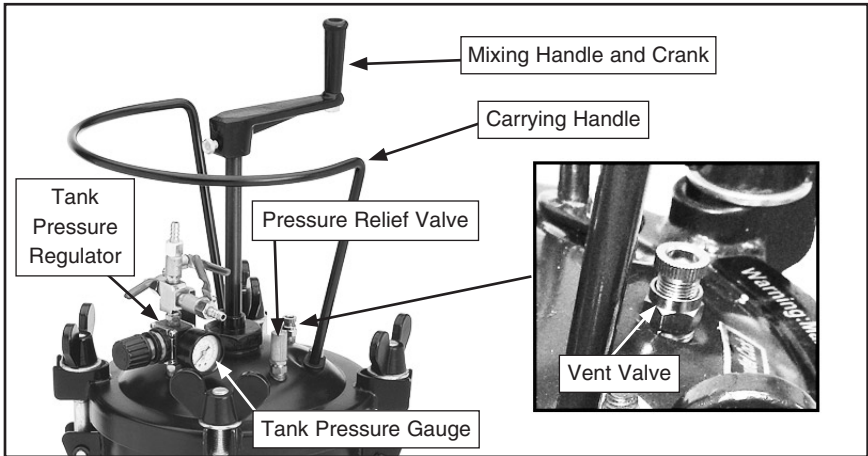

Figure 2. Controls and features.

## To assemble the paint tank:

1. Open the lid and remove the hardware shipped with the tank.
2. Install the four caster assemblies with the hex nuts and washers, as shown in Figure 3.
5. Connect the 1/4" push-on hose fittings to your air supply hose and onto the inlet fitting on the regulator (Figure 4).



Figure 3. Assembly items.

3. Invert the tank lid, slide the propeller onto the shaft, and snug the hex bolt in place (Figure 3).
4. Place the hand crank onto the shaft, and snug the hex bolt in place (Figure 3).

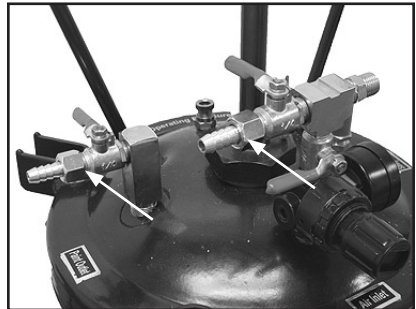

Figure 4. Spray gun fittings installed.



# OPERATIONS

**! DANGER**



**EXPLOSION HAZARD! DO NOT smoke or have any source of flame or spark near spraying. Vapors will explode if ignited.**

**! WARNING**

**Do not exceed the 45 PSI maximum operating pressure on your paint tank. Exceeding the maximum pressure may cause the tank to explode, causing serious personal injury.**

**! WARNING**



**TOXIC FUMES! Always use an approved spray booth or well ventilated area when spraying. NEVER spray in a confined space where toxic fumes and flammable vapors can accumulate to deadly levels.**

## Tank Regulator and Spray Guns

The pressure regulator on the paint tank controls the pressure in the tank. In turn, the paint is fed to the spray gun at this tank pressure.

**Note:** *The pressures suggested for the gun types listed below are typical operating guidelines:*

**Internal Mix Guns:** Use higher tank pressures up to the full amount of air pressure being delivered to the spray gun. However, do not exceed 45 PSI at the spray gun or in the paint tank.

**External Mix Guns:** Use lower tank pressures—approximately 12 PSI for most external mix guns. Start with the tank at "zero" pressure and increase pressure gradually until the correct spray pattern is achieved.

**! WARNING**



**RESPIRATORY HAZARD! Always use a NIOSH approved respirator when using spray equipment. Failure to protect your lungs can lead to respiratory illness and nervous system damage. Spraying some paints and varnishes may require a supplied air respirator system.**

## **!WARNING**

**EXPLOSION HAZARD!**  
Never exceed 45 PSI when pressurizing the tank.

## **!WARNING**

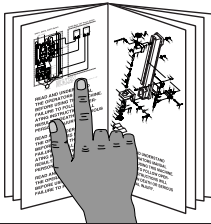

**Read the manual before operation. Become familiar with this tool, its safety instructions, and its operation before beginning any work. Serious personal injury may result if safety or operational information is not understood or followed.**

## **NOTICE**

**This paint tank is not designed for use with highly abrasive, corrosive, or rust inducing materials. If such materials are used, frequently and thoroughly clean all components to reduce the need to replace parts.**

## **Operation**

**To use the paint tank:**

1. Open the vent valve (**Figure 6**) to exhaust any tank pressure, and observe the tank regulator gauge (**Figure 5**) to make sure the tank un-pressurized.
2. Open the lid. Mix and strain your paint into the tank.
3. Wipe a thin layer of petroleum jelly onto the rubber lid seal, and secure the lid to the tank by tightening the four wing nuts in an alternating pattern.
4. Close all three valve levers on the tank (**Figure 4**), and rotate the tank regulator knob two turns counterclockwise.
5. Connect air pressure to the tank, and slowly open the tank supply air valve. Adjust the regulator knob so the pressure is within 10-45 PSI.
6. Open the gun air supply valve, and adjust the gun regulator (if equipped) to the manufacturer's recommended PSI; typically no more than 60 PSI.
7. Open the paint supply valve and begin making some test sprays. Fine tune the paint gun and the air pressure settings to achieve your desired results.
8. Periodically rotate the crank handle to mix the paint.

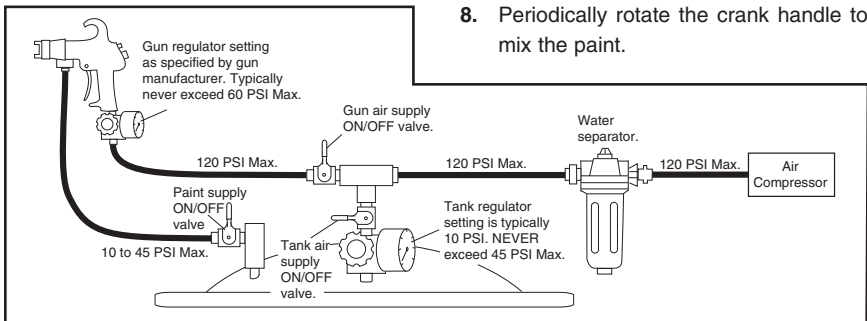

**Figure 5.** Paint tank connect to air compressor and spray gun.

# CLEANING AND LUBRICATION

## Cleaning the Tank

Proper cleaning is the best way to ensure trouble free performance from your paint tank. If your tank is not thoroughly cleaned, damage and poor operation will result. Problems caused by improper cleaning will not be covered by the warranty. Clean the tank immediately after each use.

### To clean the paint tank:

1. DISCONNECT THE AIR SUPPLY FROM THE TANK!

## **!WARNING**

**EXPLOSION HAZARD! Removing the lid while the tank is pressurized could result in lid being thrown violently from tank, causing serious personal injury. Always shut off air pressure at source and bleed off all pressure in tank before removing lid.**

2. Open the vent valve (Figure 6) to exhaust any tank pressure, and observe the tank regulator gauge (Figure 6) to make sure the tank is un-pressurized.

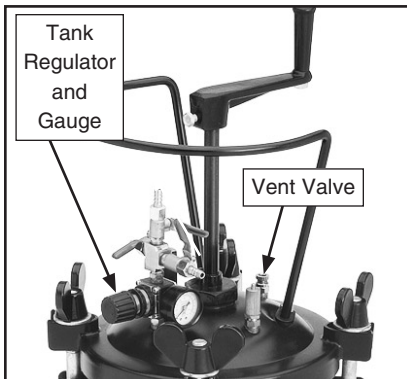

Figure 6. Regulator and vent valve.

3. Open the tank lid.
4. Empty and clean the tank of all paint, and fill it with 1 quart of solvent.
5. Replace the lid, tighten the clamps, and spray the gun until it sprays clean solvent.





**Note:** Check with local laws regarding this practice. Spraying solvents into the air may be illegal in your area. A cabinet style spray gun cleaner may be required.

6. Wearing safety goggles and gloves, use solvent to thoroughly rinse all parts that came in contact with the material, blow out ports with compressed air and let air dry.
7. Make sure all the fittings on the tank and regulator, valve, and material hose are free of hardened material that could prevent free movement of air.

# Tank Troubleshooting

Symptom	Possible Cause	Solution
Air escaping from regulator port.	1. Broken or damaged diaphragm in tank regulator.	1. Replace tank regulator.
Pressure dropping slowly on regulator.	1. Dirty or worn valve seat in regulator. 2. Loose air fittings leaking air.	1. Replace tank regulator. 2. Tighten loose air fittings or remove and re-install with new Teflon tape.
Fluid or air leak at lid gasket.	1. Defective lid gasket. 2. Wing screw loose. 3. Dirt or foreign object between gasket and rim.	1. Replace lid gasket. 2. Tighten wing screws evenly. 3. Clean rim and gasket.
Paint tends to settle rapidly in tank.	1. Paint not mixed or thinned sufficiently.	1. Mix or thin paint according to manufacturer's instructions.
Gauge not registering air pressure.	1. Air pressure turned <b>OFF</b> . 2. Defective pressure gauge.	1. Turn air pressure <b>ON</b> . 2. Replace pressure gauge.
Safety valve popping out.	1. Tank pressure too high. 2. Defective safety valve.	1. Reduce tank pressure to 25-30 PSI. 2. Replace safety valve.

# Troubleshooting

Symptom	Possible Cause	Solution
Fluttering or spitting spray. 	<ol style="list-style-type: none"> <li>1. Dry or worn fluid tip seat permits air to seep into fluid passage.</li> <li>2. Material level too low.</li> <li>3. Fluid tip or filter obstructed.</li> <li>4. Dry needle packing.</li> </ol>	<ol style="list-style-type: none"> <li>1. Tighten fluid tip or replace seat with new one.</li> <li>2. Add material.</li> <li>3. Clean.</li> <li>4. Lubricate needle.</li> </ol>
Uneven top or bottom pattern. 	<ol style="list-style-type: none"> <li>1. Atomizing cap holes are obstructed.</li> <li>2. Build-up material on top or bottom of fluid tip.</li> <li>3. Build-up material on atomizing cap is on needle seat.</li> </ol>	<ol style="list-style-type: none"> <li>1. Clear holes.</li> <li>2. Clean.</li> <li>3. Clean.</li> </ol>
Right or left arc pattern. 	<ol style="list-style-type: none"> <li>1. Left or right side horn holes are plugged.</li> <li>2. Build-up on left or right side of fluid tip.</li> <li>3. Build-up of material inside atomizing cap.</li> </ol>	<ol style="list-style-type: none"> <li>1. Clear holes.</li> <li>2. Clean.</li> <li>3. Clean.</li> </ol>
Heavy deposit of material in center. 	<ol style="list-style-type: none"> <li>1. The material flow exceeds the atomizing cap capacity.</li> <li>2. Inlet air pressure is too low.</li> <li>3. Material is too thick.</li> </ol>	<ol style="list-style-type: none"> <li>1. Reduce fluid flow.</li> <li>2. Increase inlet air pressure.</li> <li>3. Thin material.</li> </ol>
Narrow center pattern. 	<ol style="list-style-type: none"> <li>1. Volume control turned in too far.</li> <li>2. Inlet air pressure too high.</li> <li>3. Fluid pressure is too low.</li> <li>4. Material is too thin.</li> </ol>	<ol style="list-style-type: none"> <li>1. Increase volume.</li> <li>2. Reduce inlet air pressure.</li> <li>3. Increase fluid pressure.</li> <li>4. Adjust material.</li> </ol>
No spray output.	<ol style="list-style-type: none"> <li>1. No pressure at gun.</li> <li>2. Fluid passages dirty.</li> <li>3. Fluid control closed.</li> <li>4. Out of paint.</li> <li>5. Material too thick.</li> </ol>	<ol style="list-style-type: none"> <li>1. Check air supply.</li> <li>2. Clean gun, remove any obstructions.</li> <li>3. Open.</li> <li>4. Refill.</li> <li>5. Thin to manufacturer's recommendations.</li> </ol>

<b>Symptom</b>	<b>Possible Cause</b>	<b>Solution</b>
Excessive over-spray.	<ol style="list-style-type: none"> <li>1. Fluid pressure too high.</li> <li>2. Gun is too far from surface.</li> <li>3. Spraying too fast.</li> </ol>	<ol style="list-style-type: none"> <li>1. Reduce fluid pressure.</li> <li>2. Keep gun at recommended distance.</li> <li>3. Slow down and maintain consistent, even parallel stroke.</li> </ol>
Unable to control spray fan.	<ol style="list-style-type: none"> <li>1. Pattern adjustment screw is not seating properly.</li> <li>2. Atomizing cap is loose.</li> </ol>	<ol style="list-style-type: none"> <li>1. Clean or replace.</li> <li>2. Tighten atomizing cap.</li> </ol>
Runs and sags.	<ol style="list-style-type: none"> <li>1. Over diluted paint.</li> <li>2. Spray sweep is too slow.</li> <li>3. Tip too close to workpiece.</li> <li>4. Damaged seal.</li> </ol>	<ol style="list-style-type: none"> <li>1. Refer to paint manufacture dilution ratios.</li> <li>2. Speed up spraying sweeps.</li> <li>3. Move tip farther away from workpiece.</li> <li>4. Replace damaged seals.</li> </ol>
Material leaks from cup.	<ol style="list-style-type: none"> <li>1. Cap not secure.</li> <li>2. Cup not tight on gun body.</li> <li>3. Leaking from cap vent hole.</li> </ol>	<ol style="list-style-type: none"> <li>1. Tighten.</li> <li>2. Tighten.</li> <li>3. Hold gun upright; do not tilt.</li> </ol>
Material leaks from gun.	<ol style="list-style-type: none"> <li>1. Fluid tip loose.</li> <li>2. Dry or damaged seals.</li> <li>3. Excessive pressure.</li> </ol>	<ol style="list-style-type: none"> <li>1. Tighten.</li> <li>2. Replace seals.</li> <li>3. Reduce pressure.</li> </ol>
Thick dimpled finish, aka "Orange Peel."	<ol style="list-style-type: none"> <li>1. Holding gun too close to surface.</li> <li>2. Inlet air pressure too low.</li> <li>3. Material not properly mixed.</li> <li>4. Surface is dirty or oily.</li> </ol>	<ol style="list-style-type: none"> <li>1. Spray at recommended distance.</li> <li>2. Check inlet air pressure.</li> <li>3. Follow manufacturer's instructions.</li> <li>4. More surface prep is required.</li> </ol>
Dry Spray.	<ol style="list-style-type: none"> <li>1. Inlet air pressure too high.</li> <li>2. Gun too far from surface.</li> <li>3. Gun stroke too fast.</li> </ol>	<ol style="list-style-type: none"> <li>1. Lower inlet air pressure.</li> <li>2. Keep gun at recommended distance.</li> <li>3. Slow down and maintain consistent even parallel stroke.</li> </ol>
Gun leaks from fluid tip.	<ol style="list-style-type: none"> <li>1. Debris will not let the needle seat with the fluid tip.</li> </ol>	<ol style="list-style-type: none"> <li>1. Clean or replace both.</li> </ol>
Contaminated paint, aka "Fish Eyes."	<ol style="list-style-type: none"> <li>1. Work surface has oil spots, or was improperly cleaned and primed.</li> <li>2. Water or oil in the air line.</li> </ol>	<ol style="list-style-type: none"> <li>1. Wait until finish is dry and cured, re-sand clean and re-prime, and repaint.</li> <li>2. Install an in-line air filter.</li> </ol>

# H6329 PAINT TANK

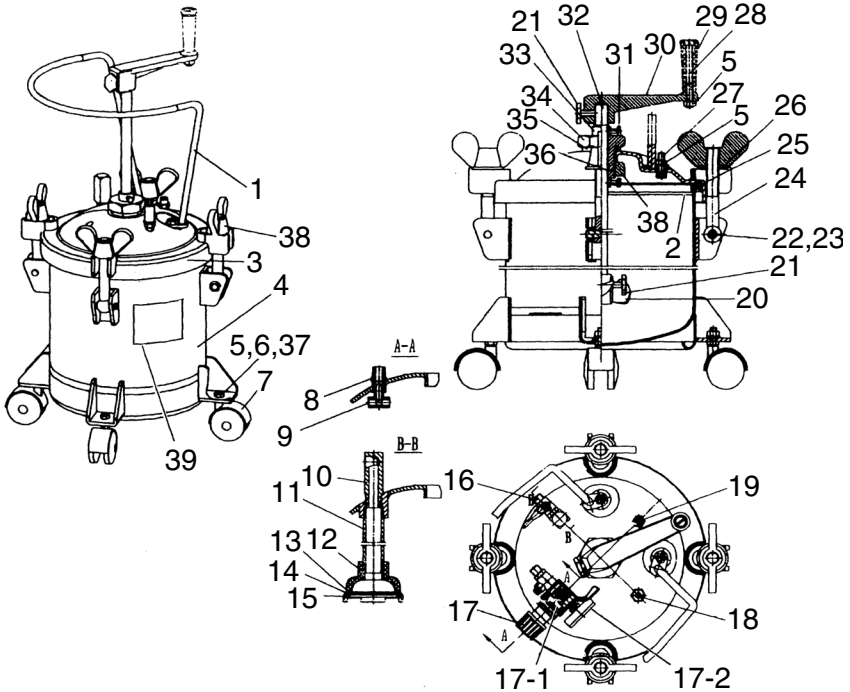

REF	PART #	DESCRIPTION
1	PH6329001	HANDLE
2	PH6329002	LID GASKET
3	PH6329003	COMPLETE LID ASSEMBLY
4	PH6329004	TANK
5	PN03M	HEX NUT M8-1.25
6	PLW04M	LOCK WASHER 8MM
7	PH6329007	SWIVEL CASTER
8	PH6329008	AIR INLET CONNECTION
9	PH6329009	AIR DEFLECTOR
10	PH6329010	FLUID OUTLET BODY
11	PH6329011	STAND PIPE
12	PH6329012	FILTER BODY
13	PH6329013	FILTER WASHER
14	PH6329014	FILTER SCREEN
15	PH6329015	SCREEN RETAINER
16	PH6329016	PAINT OUTLET VALVE
17	PH6329017	AIR REGULATOR
17-1	PH6329017-1	AIR REGULATOR HOUSING
17-2	PH6329017-2	PRESSURE GAUGE 180PSI
18	PH6329018	PRESSURE RELIEF VALVE
19	PH6329019	AIR VENT VALVE

REF	PART #	DESCRIPTION
20	PH6329020	MIXING PROPELLER
21	PB06M	HEX BOLT M8-1.25 X 12
22	PH6329022	PIN
23	PH6329023	E-CLIP 8.5MM
24	PH6329024	LOCK STUD
25	PH6329025	SEALING WASHER
26	PW14	FLAT WASHER 5/8
27	PB07M	HEX BOLT M8-1.25 X 25
28	PH6329028	SHOULDERED BOLT
29	PH6329029	CRANK HANDLE
30	PH6329030	COMPLETE CRANK ASSEMBLY
31	PB02M	HEX BOLT M6-1 X 12
32	PH6329032	PROPELLER SHAFT
33	PH6329033	COLLAR
34	PH6329034	SEALING WASHER
35	PORP016	O-RING 15.8 X 2.4 P16
36	PH6329036	SHAFT HOUSING
37	PW01M	FLAT WASHER 8MM
38	PH6329038	WING NUT
39	PH6329039	MACHINE ID LABEL





## Free Manuals Download Website

<http://myh66.com>

<http://usermanuals.us>

<http://www.somanuals.com>

<http://www.4manuals.cc>

<http://www.manual-lib.com>

<http://www.404manual.com>

<http://www.luxmanual.com>

<http://aubethermostatmanual.com>

Golf course search by state

<http://golfingnear.com>

Email search by domain

<http://emailbydomain.com>

Auto manuals search

<http://auto.somanuals.com>

TV manuals search

<http://tv.somanuals.com>