

# *Grizzly* Industrial, Inc.®

## 18 GAUGE STAPLER KIT

### MODEL G6042/3

## INSTRUCTION MANUAL



Model G6042



Model G6043

COPYRIGHT © OCTOBER, 2001 BY GRIZZLY INDUSTRIAL, INC.

1821 VALENCIA ST., BELLINGHAM, WA 98227

**WARNING: NO PORTION OF THIS MANUAL MAY BE REPRODUCED IN ANY SHAPE OR FORM WITHOUT THE WRITTEN APPROVAL OF GRIZZLY INDUSTRIAL, INC.**

PRINTED IN TAIWAN

# SAFETY

## WARNING

### For Your Own Safety Read Instruction Manual Before Operating This Equipment

The purpose of safety symbols is to attract your attention to possible hazardous conditions. This manual uses a series of symbols and signal words which are intended to convey the level of importance of the safety messages. The progression of symbols is described below. Remember that safety messages by themselves do not eliminate danger and are not a substitute for proper accident prevention measures.



Indicates an imminently hazardous situation which, if not avoided, WILL result in death or serious injury.



Indicates a potentially hazardous situation which, if not avoided, COULD result in death or serious injury.



Indicates a potentially hazardous situation which, if not avoided, MAY result in minor or moderate injury. It may also be used to alert against unsafe practices.



This symbol is used to alert the user to useful information about proper operation of the equipment.

## WARNING

### Safety Instructions For Power Tools

1. **KEEP ALL SAFETY DEVICES IN PLACE** and in working order.
2. **REMOVE ADJUSTING KEYS AND WRENCHES.** Form habit of checking to see that keys and adjusting wrenches are removed from tool before operation.
3. **KEEP WORK AREA CLEAN.** Cluttered areas and benches invite accidents.
4. **DO NOT USE IN DANGEROUS ENVIRONMENT.** Do not use power tools in damp or wet locations, or where any flammable or noxious fumes may exist. Keep work area well lighted.
5. **KEEP CHILDREN AND VISITORS AWAY.** All children and visitors should be kept a safe distance from work area.
6. **MAKE WORKSHOP CHILD PROOF** with padlocks, master switches, or by removing starter keys.
7. **DO NOT FORCE TOOL.** It will do the job better and safer at the rate for which it was designed.
8. **USE THE RIGHT TOOL.** Do not force tool or attachment to do a job for which it was not designed.
9. **DO NOT USE UNDER THE INFLUENCE OF DRUGS OR ALCOHOL.**

# WARNING

## Safety Instructions For Power Tools

- 10. USE PROPER EXTENSION CORD** for the tool. Make sure your extension cord is in good condition. Conductor size should be in accordance with the chart below. The amperage rating should be listed on the motor or tool nameplate. An undersized cord will cause a drop in line voltage resulting in loss of power and overheating. Your extension cord must also contain a ground wire and plug pin. Always repair or replace extension cords if they become damaged.

Minimum Gauge for Extension Cords

AMP RATING	LENGTH		
	25ft	50ft	100ft
0-6	18	16	16
7-10	18	16	14
11-12	16	16	14
13-16	14	12	12
17-20	12	12	10
21-30	10	10	No

- 15. MAINTAIN TOOLS WITH CARE.** Keep tools sharp and clean for best and safest performance. Follow instructions for lubricating and changing accessories.
- 16. DISCONNECT TOOLS** before servicing and changing accessories.
- 17. REDUCE THE RISK OF UNINTENTIONAL STARTING.** Make sure switch is in off position before plugging in.
- 18. USE THE RECOMMENDED ACCESSORIES.** Consult the owner's manual for recommended accessories. The use of improper accessories may cause risk of injury.
- 19. CHECK DAMAGED PARTS.** Before further use of the tool, a guard or other part that is damaged should be carefully checked to determine that it will operate properly and perform its intended function. Check for alignment of moving parts, binding of moving parts, breakage of parts, mounting, and any other conditions that may affect its operation. A guard or other part that is damaged should be properly repaired or replaced.
- 20. NEVER LEAVE TOOL RUNNING UNATTENDED.** Turn the power off, and do not leave tool until it comes to a complete stop.
- 21. NEVER ALLOW UNTRAINED USERS TO RUN THIS TOOL WHILE UNSUPERVISED.**
- 22. IF YOU ARE UNSURE OF THE INTENDED OPERATION, STOP USING THE TOOL.** Seek formal training or research books or magazines that specialize in power tools.
- 11. WEAR PROPER APPAREL.** Do not wear loose clothing, gloves, neckties, rings, bracelets, or other jewelry which may get caught in moving parts. Non-slip footwear is recommended. Wear protective hair covering to contain long hair.
- 12. ALWAYS USE SAFETY GLASSES.** Also use face or dust mask if cutting operation is dusty. Everyday eyeglasses only have impact resistant lenses, they are NOT safety glasses.
- 13. SECURE WORK.** Use clamps or a vise to hold work when practical. It is safer than using your hand and frees both hands to operate tool.
- 14. DO NOT OVERREACH.** Keep proper footing and balance at all times.

# ! WARNING

## Basic Stapler Safety

In addition to the rules stated in the previous section, and those in the warning boxes throughout this manual, please observe the following safety tips for your new stapler:

1. **READ THIS ENTIRE MANUAL BEFORE OPERATING THE STAPLER.**
2. **ALWAYS DISCONNECT AIR FROM THE STAPLER** whenever servicing or installing staples. During maintenance, a stapler connected to air may fire accidentally, causing serious personal injury.
3. **DO NOT PLACE HANDS NEAR STAPLE POINT OF ENTRY.** Staple can deflect and tear through the surface of the workpiece, puncturing your hand or fingers.
4. **NEVER CONNECT THE STAPLER TO PRESSURIZED OXYGEN OR OTHER COMBUSTIBLE GASES** as a power source. Only use filtered, lubricated, and regulated compressed air.
5. **NEVER USE GASOLINE OR OTHER FLAMMABLE LIQUIDS TO CLEAN THE STAPLER.** Vapors in the tool will ignite by a spark and cause the tool to explode.
6. **DO NOT CARRY THE STAPLER BY ANY OTHER PART THAN THE HANDLE,** and do not carry the stapler by the air hose.
7. **DO NOT KEEP THE TRIGGER PULLED ON THE SAFETY YOKE MECHANISM WHEN CARRYING OR HOLDING THE TOOL.**
8. **DO NOT USE A CHECK VALVE OR ANY OTHER FITTING** that allows air to remain in the tool.

## ! WARNING

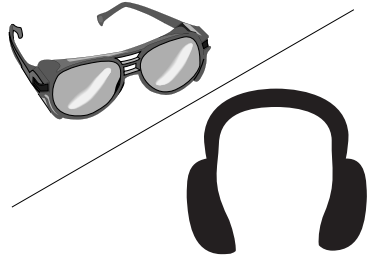

Operating this stapler can propel objects into the air, causing immediate eye damage. To protect yourself, always wear American National Standards Institute (ANSI) approved safety glasses or goggles when operating this equipment. In addition, this stapler discharges at 85-90 decibels. To protect your hearing, always wear ANSI approved ear protection when operating this stapler.

## ! WARNING



Never point this stapler at yourself or another person! Always pay attention to the direction this stapler is pointed. Use this tool with respect and caution to lessen the possibility of operator or bystander injury. Ignoring this warning may result in serious personal injury.

# INTRODUCTION

## Commentary

We are proud to offer the Grizzly Model G6042/G6043 18 Gauge Stapler. This model is part of a growing Grizzly family of fine power tools. When used according to the guidelines set forth in this manual, you can expect years of trouble-free, enjoyable operation and proof of Grizzly's commitment to customer satisfaction.

This stapler features 360° adjustable exhaust, a convenient bottom-loading magazine, a safety trigger and a durable plastic carrying case.

We are pleased to provide this manual with the Model G6042/G6043. It was written to encourage safety considerations and guide you through general operating procedures and maintenance. This manual represents our effort to produce the best documentation possible.

The specifications, details, and photographs in this manual represent the Model G6042/G6043 as supplied when the manual was prepared. However, owing to Grizzly's policy of continuous improvement, changes may be made at any time with no obligation on the part of Grizzly. If you have any comments regarding this manual, please write to us at the address below:

Grizzly Industrial, Inc.  
% Technical Documentation  
P.O. Box 2069  
Bellingham, WA 98227-2069

Most importantly, we stand behind our tools. If you have any service questions or parts requests, please call or write us at the location listed below.

Grizzly Industrial, Inc.  
1203 Lycoming Mall Circle  
Pennsdale, PA 17756  
Phone: (570) 546-9663  
Fax: (800) 438-5901

E-Mail: [techsupport@grizzly.com](mailto:techsupport@grizzly.com)  
Web Site: <http://www.grizzly.com>

## ! WARNING

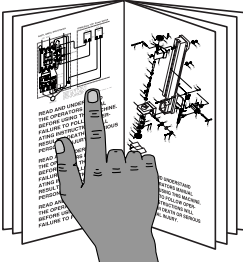

**Read the manual before assembly and operation. Become familiar with this tool, its safety instructions, and its operation before beginning any work. Serious personal injury may result if safety or operational information is not understood or followed.**

## Compressed Air System

The Model G6042/G6043 is designed to be operated at 60-100 psi. **Do not exceed the maximum operating pressure for your model.**

Before you use your new stapler, install the  $\frac{3}{8}$ " quick connect fitting that comes with the stapler. Install a female  $\frac{3}{8}$ " fitting on the air hose. Regulate the air pressure on your air compressor to barely over the minimum psi for your model.

Many pneumatic tools benefit from an in-line filter/lubricator/regulator unit. This attachment is connected by hoses between the air compressor and the stapler. Using this unit protects your tool from damaging water build-up, allows you to adjust and maintain constant air pressure to your tool, and saves you the inconvenience of having to manually lubricate your tool every time you use it. Check the current Grizzly catalog for availability of this unit. If you plan on installing a filter/lubricator/regulator unit in your compressed air system, always follow the connection instructions that come with the unit.

**! WARNING**

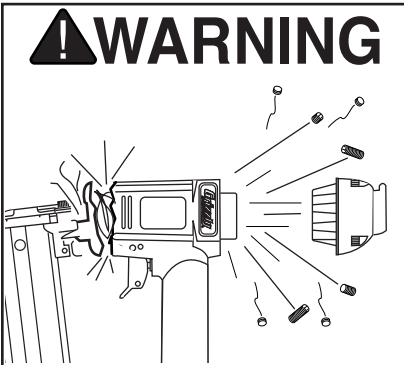

**Exceeding the maximum permissible operating pressure may cause the stapler to explode, blowing metal fragments in all directions. To protect yourself from serious personal injury, DO NOT allow your air compressor to exceed the recommended pressure when connected to this stapler!**

G6042/G6043 18 Gauge Stapler Kit

## Safety Yoke Mechanism

A safety yoke mechanism (bump fire) on the nose of the stapler acts as a secondary safety device. When the trigger is pressed, the stapler will not fire until the safety yoke mechanism is depressed.

Before you use your stapler for the first time, check the safety yoke mechanism to ensure proper function. To do this:

1. **Make sure the stapler is disconnected from the air supply!**
2. Make sure the magazine is empty and contains no staples.
3. Make sure the trigger and the safety yoke mechanism move up and down without sticking.
4. Connect the stapler to the air supply.
5. **Without pressing the trigger**, depress the safety yoke mechanism against a scrap piece of wood that is clean and free of any knots, staples, or other foreign objects. If the stapler does not fire, then the safety yoke mechanism is working correctly. If the stapler **does fire** when you do this, immediately disconnect the stapler from the air supply and call our customer service for help.

Similarly if the stapler fires when the trigger is pulled, **without the safety yoke mechanism being depressed**, then the stapler is not working properly.

If either of these two conditions develop after you have used your stapler for a period of time, check the lubrication of these mechanisms.

**! WARNING**

**The safety yoke is a mechanical device that can fail. Never rely on the safety yoke mechanism as an excuse to point the stapler at yourself or any bystanders. Serious injury may occur.**

-5-

# OPERATION

## Loading Stapler

To load your stapler:

1. **Disconnect the air supply from the stapler!**
2. Push the magazine latch in the direction shown in **Figure 1**.

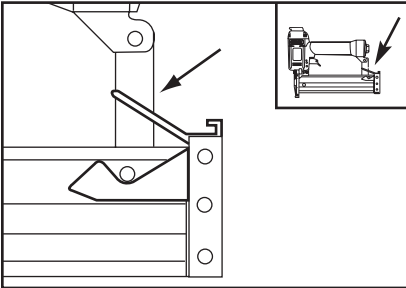

**Figure 1.** Releasing magazine latch.

3. Pull back the magazine cover until it stops.

4. Point the stapler up and insert a stick of staples into the magazine as shown in **Figure 2**. Make sure that the pointed ends of the staples point in the same direction as the stapler nose piece.

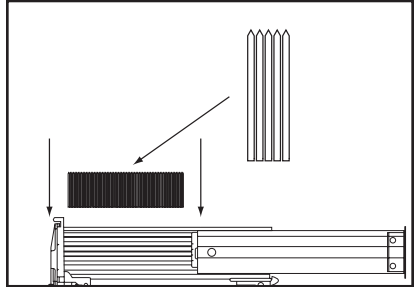

**Figure 2.** Loading staples into stapler.

5. Push the magazine cover forward until the magazine latch locks in place.

## Operating Stapler

**If you have not read the safety instructions in this manual, do not operate the stapler.**

Before you operate your stapler, place one drop of the included oil into the quick connect fitting where the stapler connects to the air supply. Fire the EMPTY stapler 3-4 times before beginning, so oil does not come out onto the project during regular operation.

To operate your stapler:

1. Connect the air supply to the quick connect fitting.
2. Test the loaded stapler for proper penetration. Hold the stapler perpendicular to the surface of a piece of clean scrap wood that is thick enough for the length of staples you have loaded. Depress the safety yoke mechanism on your workpiece.
3. Before pressing the trigger, make sure your free hand is positioned out of the way of a potential path of a staple in case of deflection. (Deflection is caused when the staple changes its path, resulting in the staple puncturing the surface of the workpiece as shown in **Figure 3**.)

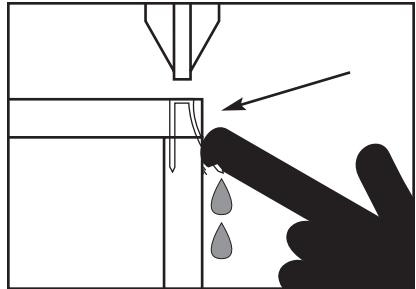

**Figure 3.** Example of staple deflection.

Besides damaging your workpiece, deflection can cause injury if your free hand is securing the workpiece in the location that the staple deflects.

4. Press the trigger. If the staple drove into the wood far enough, continue with your intended operations. If the staple either went too far or not far enough, then adjust the air pressure. More air pressure will make the staple go deeper and less air pressure will decrease the staple penetration.



## Clearing Jammed Staples

The most frequent situation with any type of stapler is a staple jam. A jammed staple must be cleared before using the stapler again. The two places where a staple can get jammed are the magazine and the discharge area.

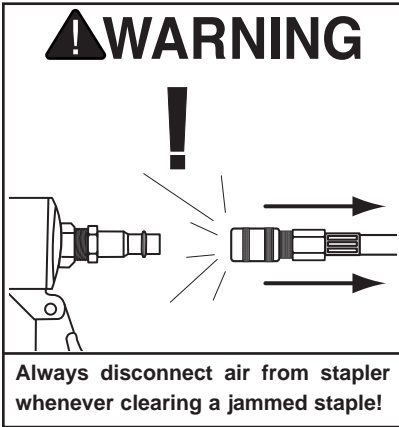

To clear a jammed staple from the magazine:

1. **Disconnect the stapler from the air supply!**
2. Open the magazine cover and pull the magazine all the way back.
3. Locate and remove the jammed staple with a pair of needle nose pliers. Close the magazine cover so it latches.

To clear a jammed staple from the discharge area:

1. **Disconnect the stapler from the air supply!**
2. Remove all of the staples from the magazine.
3. The jammed staple should now be visible; remove it from the discharge area with needle nose pliers.
4. Replace the staples. Push the magazine closed and snap the quick release latch back into operating position.

## Oiling Stapler

Special oil has been included with your new Grizzly stapler to help maintain its useful life. Place one drop of oil in the stapler air inlet (as shown in **Figure 4**) before every use. Wipe off any excess oil near the stapler exhaust to avoid dust build-up. When the oil that was included with the stapler has been completely used, replace with Grizzly Model G2820 Pneumatic Tool Oil.

Another option to manual oiling would be to install a lubricator in your air compressor line. If your air compressor line already has a lubricator, then regular lubrication of your stapler will not be necessary. Just make sure there is always oil in the lubricator.

As mentioned before, the best option is to install a filter/lubricator/regulator unit such as the Grizzly Model H2333 in your air line.

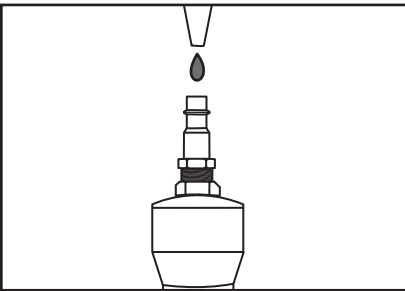

**Figure 4.** Lubricating stapler via air inlet.

## Cleaning Stapler

Use a good solvent to clean the nose assembly of the stapler. Always be sure that the stapler is dry before using it again.

Do not allow dust, chips, sand, etc. into the air connectors or into the body of the stapler; this may result in leaks and damage to the stapler and the air couplings.



**Never use use gasoline or other flammable liquids to clean this tool. Vapors in the tool may ignite, causing the tool to explode. Ignoring this warning may lead to serious personal injury or even death!**

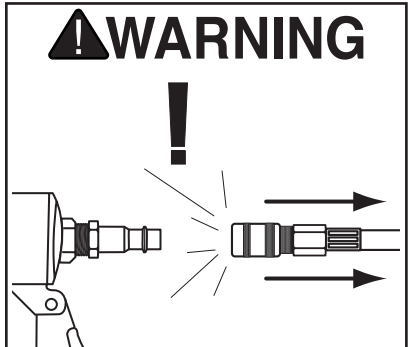

**Always disconnect air from stapler whenever servicing! During maintenance, a stapler connected to air may fire accidentally, causing serious personal injury!**

## Replacing Pistons/O-Rings

If you use your stapler day in and day out, Grizzly offers repair pistons as cheap insurance against wasted down time and lost profits in the event that a piston or piston shaft becomes worn out. To replace a piston:

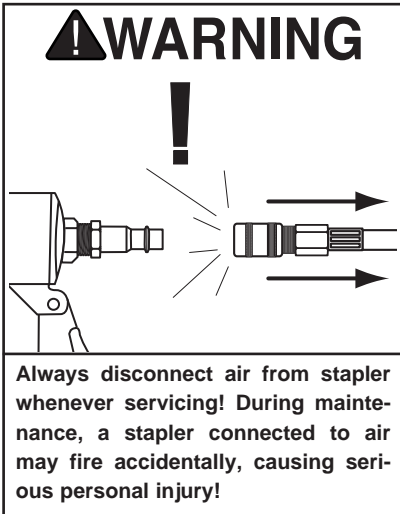

**Always disconnect air from stapler whenever servicing! During maintenance, a stapler connected to air may fire accidentally, causing serious personal injury!**

1. **Disconnect the stapler from the air supply!**
2. Remove all staples from the magazine cartridge.
3. Remove the 4 cap screws from the stapler exhaust cap.
4. Remove the exhaust cap as shown in **Figure 5**.
5. The top of the piston should now be visible inside the cylinder, which is housed in the head of the stapler.
6. Open the magazine.
7. Watch the discharge area and push the top of the piston with your finger. You will see the piston shaft slide down the discharge area.

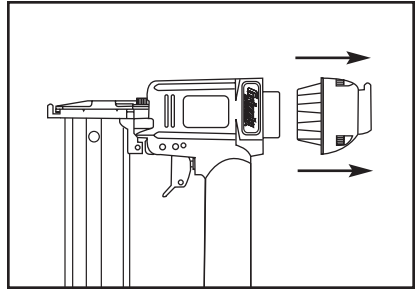

**Figure 5.** Removing stapler exhaust cap.

8. With a long flathead screwdriver or similarly shaped tool, push the piston shaft back inside the stapler until you can grip the piston head and remove it from the cylinder. (Be careful not to scratch the discharge area when pushing the piston shaft with the screwdriver.)
9. Place a new O-ring on the new piston and apply a thin film of the stapler lubricating oil on the O-ring.
10. Insert the new piston in the cylinder. Make sure that the grooves on the piston shaft line up with those on the guide. The new piston should easily slide into the cylinder. **Do not force the piston into the cylinder!** If the piston is not easily inserted, double-check the alignment of the piston shaft with the grooves on the guide.
11. After the piston is inserted correctly, close the magazine. Replace the rear cap assembly and tighten the 4 cap screws.
12. For more assistance, or to install a complete O-ring set, refer to the appropriate breakdown diagram in the back of this manual.

# MAINTENANCE NOTES

---

---

# G6042 PART BREAKDOWN

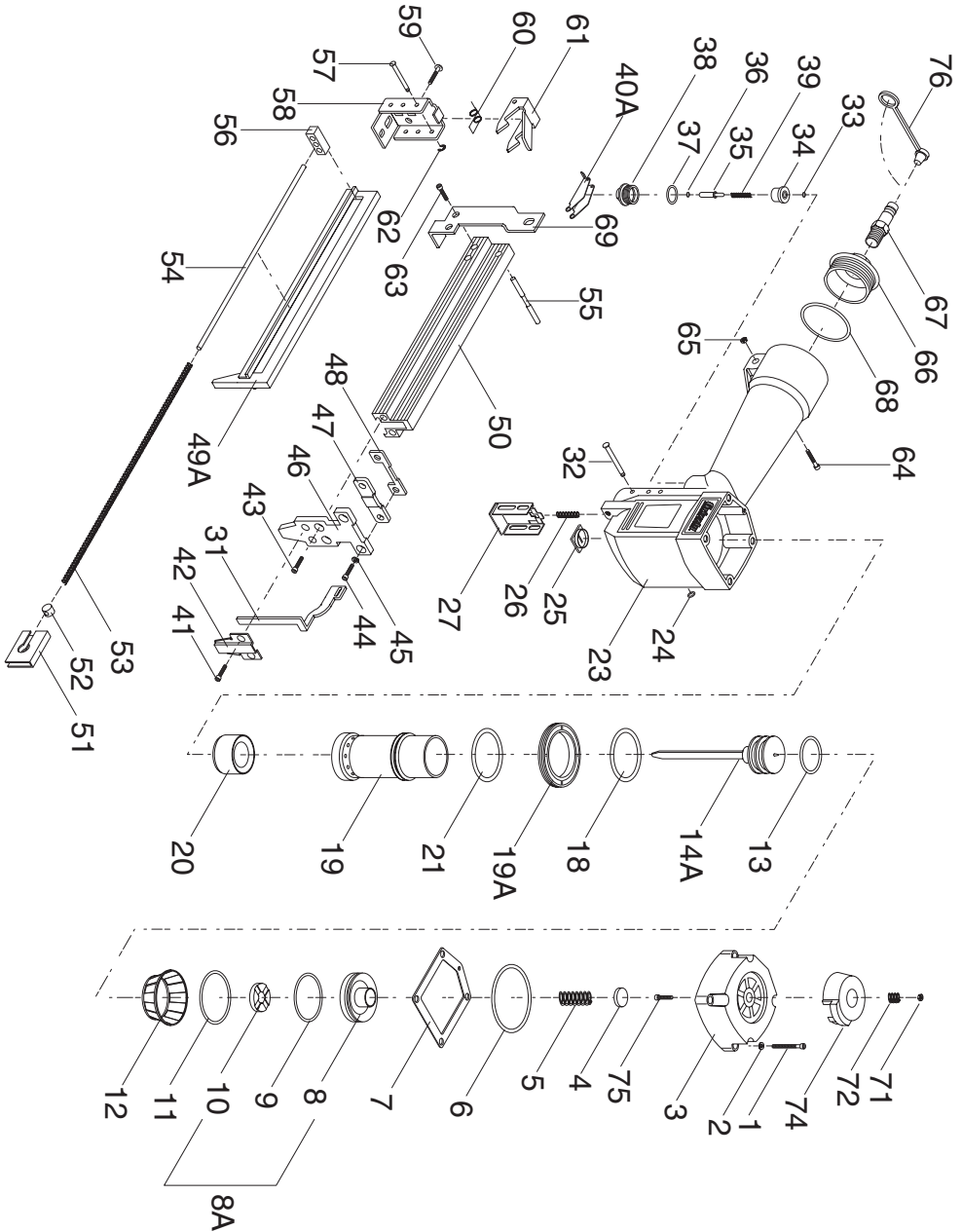

REF	PART #	DESCRIPTION
01	P6042001	CAP SCREW
02	P6042002	LOCK WASHER
03	P6042003	CAP
04	P6042004	SEAL
05	P6042005	SPRING
06	P6042006	O-RING
07	P6042007	CAP SEAL
08	P6042008	PISTON HEAD VALVE
08A	P604200A	PISTON HEAD ASSY
09	P6042009	O-RING
10	P6042010	STOPPER
11	P6042011	O-RING
12	P6042012	COLLAR
13	P6042013	O-RING
14A	P6042014A	DRIVER ASSEMBLY
18	P6042018	O-RING
19	P6042019	CYLINDER
19A	P6042019A	COLLAR
20	P6042020	BUMPER
21	P6042021	O-RING
23	P6042023	BODY
24	P6042024	E-RING
25	P6042025	JOINT GUIDE
26	P6042026	SPRING
27	P6042027	GUIDE SAFETY LVR
31	P6042031	SAFETY YOKE
32	P6042032	STEPPED PIN
33	P6042033	O-RING
34	P6042034	TRGR VALVE HEAD
35	P6042035	TRGR VALVE STEM
36	P6042036	O-RING
37	P6042037	O-RING
38	P6042038	TRGR VALVE GUIDE
39	P6042039	SPRING
40A	P6042040A	TRIGGER
41	P6041041	CAP SCREW

REF	PART #	DESCRIPTION
42	P6042042	NOSE COVER
43	P6042043	CAP SCREW
44	P6042044	CAP SCREW
45	P6042045	LOCK WASHER
46	P6042046	NOSE
47	P6042047	SET PLATE
48	P6042048	SET PLATE
49A	P6042049A	STAPLE GUIDE UNIT
50	P6042050	MAGAZINE
51	P6042051	PUSHER
52	P6042052	SLIDE BLOCK
53	P6042053	SPRING
54	P6042054	ROD
55	P6042055	SHAFT
56	P6042056	SET BLOCK
57	P6042057	STEPPED PIN
58	P6042058	END CORE
59	P6042059	ROUND HD CAP SCR
60	P6042060	TORSION SPRING
61	P6042061	STOPPER
62	P6042062	E-RING
63	P6042063	CAP SCREW
64	P6042064	CAP SCREW
65	P6042065	LOCK NUT
66	P6042066	COVER
67	P6042067	AIR FITTING
68	P6042068	O-RING
69	P6042069	BRACKET
71	P6042071	LOCK NUT
72	P6042072	SPRING
74	P6042074	EXHAUST COVER
75	P6042075	CAP SCREW
76	PRP50M	RUBBER INLET PLUG
500	P6042500	PISTON/O-RING SET*
501	P6042501	CARRYING CASE*
502	P6042502	O-RING SET*

\* These items are not shown in the illustration.

# G6043 PART BREAKDOWN

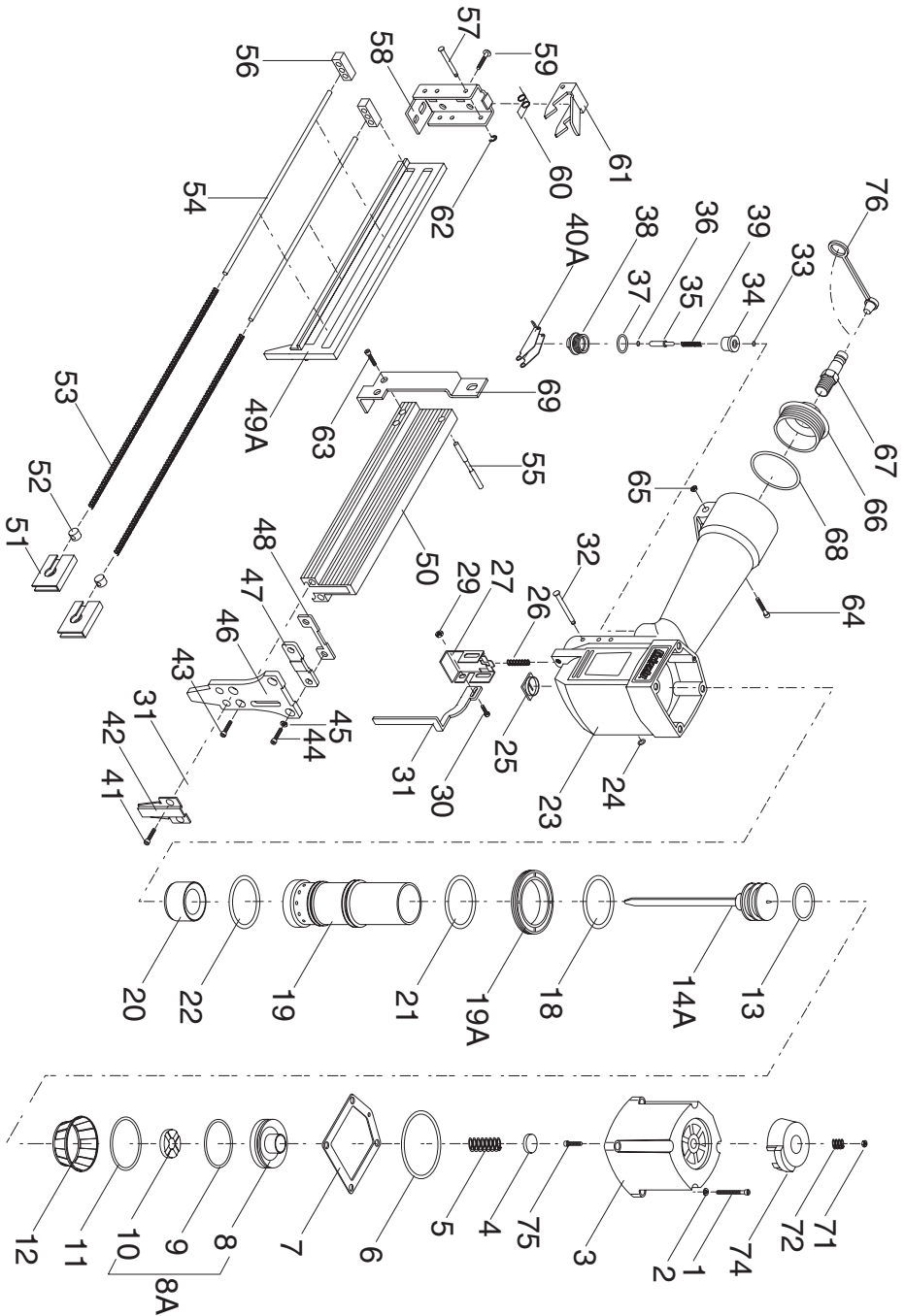

REF	PART #	DESCRIPTION
01	P6043001	CAP SCREW
02	P6043002	LOCK WASHER
03	P6043003	CAP
04	P6043004	SEAL
05	P6043005	SPRING
06	P6043006	O-RING
07	P6043007	CAP SEAL
08	P6043008	PISTON HEAD VALVE
08A	P604300A	PISTON HEAD ASSY
09	P6043009	O-RING
10	P6043010	STOPPER
11	P6043011	O-RING
12	P6043012	COLLAR
13	P6043013	O-RING
14A	P6043014A	DRIVER ASSEMBLY
18	P6043018	O-RING
19	P6043019	CYLINDER
19A	P6043019A	COLLAR
20	P6043020	BUMPER
21	P6043021	O-RING
22	P6043022	O-RING
23	P6043023	BODY
24	P6043024	E-RING
25	P6043025	JOINT GUIDE
26	P6043026	SPRING
27	P6043027	GUIDE SAFETY LVR
29	P6043029	LOCK NUT
30	P6043030	PHLP HD SCREW
31	P6043031	SAFETY YOKE
32	P6043032	STEPPED PIN
33	P6043033	O-RING
34	P6043034	TRGR VALVE HEAD
35	P6043035	TRGR VALVE STEM
36	P6043036	O-RING
37	P6043037	O-RING
38	P6043038	TRGR VALVE GUIDE
39	P6043039	SPRING

REF	PART #	DESCRIPTION
40A	P6043040A	TRIGGER
41	P6045041	CAP SCREW
42	P6043042	NOSE COVER
43	P6043043	CAP SCREW
44	P6043044	CAP SCREW
45	P6043045	LOCK WASHER
46	P6043046	NOSE
47	P6043047	SET PLATE
48	P6043048	SET PLATE
49A	P6043049A	STAPLE GUIDE UNIT
50	P6043050	MAGAZINE
51	P6043051	PUSHER
52	P6043052	SLIDE BLOCK
53	P6043053	SPRING
54	P6043054	ROD
55	P6043055	SHAFT
56	P6043056	SET BLOCK
57	P6043057	STEPPED PIN
58	P6043058	END CORE
59	P6043059	CAP SCREW
60	P6043060	TORSION SPRING
61	P6043061	STOPPER
62	P6043062	E-RING
63	P6043063	CAP SCREW
64	P6043064	CAP SCREW
65	P6043065	LOCK NUT
66	P6043066	COVER
67	P6043067	AIR FITTING
68	P6043068	O-RING
71	P6043071	LOCK NUT
72	P6043072	SPRING
74	P6043074	EXHAUST COVER
75	P6043075	CAP SCREW
76	P6043077	RUBBER INLET PLUG
500	P6043500	PISTON/O-RING SET*
501	P6043501	CARRYING CASE*
502	P6043502	O-RING SET*

\* These items are not shown in the illustration.



# TROUBLESHOOTING

PROBLEM	CAUSE	ACTION
Air leaking at trigger valve area.	1. O-rings in trigger valve housing are damaged.	1. O-rings must be replaced & operation of safety yoke must be checked.
Air leaking between housing and hose.	1. Loose screws in housing. 2. Damaged O-ring. 3. Loose air fitting.	1. Tighten screws. 2. Replace O-ring. 3. Tighten air fitting.
Air leaking between housing and cap assembly.	1. Damaged seal.	1. Replace damaged seals.
Tool skips staples while discharging.	1. Air leaks. 2. Dirt in nose. 3. Dirt or damage prevents staples from moving freely in magazine. 4. Inadequate air flow to tool. 5. Worn O-ring on piston or lack of lubrication. 6. Damaged O-rings on trigger valve. 7. Worn bumper. 8. Cap seal leaking.	1. Tighten screws and fittings. 2. Clean nose. 3. Clean magazine and inspect/repair damage. 4. Check fitting, hose, compressor & air pressure. 5. Replace piston O-ring. Lubricate. 6. Replace trigger valve O-rings. 7. Replace bumper. 8. Replace cap seal.
Tool runs slowly or has a loss of power.	1. Stapler is not sufficiently lubricated. 2. Broken spring in cap assembly. 3. Exhaust port in cap is blocked.	1. Lubricate stapler. 2. Replace spring. 3. Clean or replace damaged internal parts.
Fasteners frequently jam the stapler.	1. Staples are the wrong size. 2. Staples are bent. 3. Magazine or nose screws are loose. 4. Driver or driver guide are worn or damaged.	1. Use correct staples. 2. Use undamaged staples 3. Tighten magazine and nose screws. 4. Replace worn or damaged parts.
Stapler does not fire.	1. Staple is jammed in magazine or discharge area. 2. Piston shaft is damaged. 3. Air pressure too low.	1. Clear stapler magazine or discharge area. 2. Replace piston shaft. 3. Check/increase air pressure.

# WARRANTY AND RETURNS

---

---

Grizzly Industrial, Inc. warrants every product it sells for a period of **1 year** to the original purchaser from the date of purchase. This warranty does not apply to defects due directly or indirectly to misuse, abuse, negligence, accidents, repairs or alterations or lack of maintenance. This is Grizzly's sole written warranty and any and all warranties that may be implied by law, including any merchantability or fitness, for any particular purpose, are hereby limited to the duration of this written warranty. We do not warrant or represent that the merchandise complies with the provisions of any law or acts unless the manufacturer so warrants. In no event shall Grizzly's liability under this warranty exceed the purchase price paid for the product and any legal actions brought against Grizzly shall be tried in the State of Washington, County of Whatcom.

We shall in no event be liable for death, injuries to persons or property or for incidental, contingent, special, or consequential damages arising from the use of our products.

To take advantage of this warranty, contact us by mail or phone and give us all the details. We will then issue you a "Return Authorization Number," which must be clearly posted on the outside as well as the inside of the carton. We will not accept any item back without this number. Proof of purchase must accompany the merchandise.

The manufacturers reserve the right to change specifications at any time because they constantly strive to achieve better quality equipment. We make every effort to ensure that our products meet high quality and durability standards and we hope you never need to use this warranty.

Please feel free to write or call us if you have any questions about the machine or the manual.

Grizzly Industrial, Inc.  
1203 Lycoming Mall Circle  
Pennsdale, PA 17756  
Phone: (570) 546-9663  
Fax: (800) 438-5901

E-Mail:  
techsupport@grizzly.com

Web Site: <http://www.grizzly.com>

Thank you again for your business and continued support. We hope to serve you again soon!

# WARRANTY CARD

Name \_\_\_\_\_

Street \_\_\_\_\_

City \_\_\_\_\_ State \_\_\_\_\_ Zip \_\_\_\_\_

Phone Number \_\_\_\_\_ E-Mail \_\_\_\_\_ FAX \_\_\_\_\_

Model # \_\_\_\_\_ Order # \_\_\_\_\_

The following information is given on a voluntary basis. It will be used for marketing purposes to help us develop better products and services. Of course, all information is strictly confidential.

- How did you learn about us?  
 Advertisement       Friend  
 Catalog               Card Deck  
 World Wide Web  
 Other \_\_\_\_\_
- What is your annual household income?  
 \$20,000-\$29,999       \$60,000-\$69,999  
 \$30,000-\$39,999       \$70,000-\$79,999  
 \$40,000-\$49,999       \$80,000-\$89,999  
 \$50,000-\$59,999       \$90,000 +
- What is your age group?  
 20-29                   50-59  
 30-39                   60-69  
 40-49                   70 +
- How long have you been a woodworker?  
 0 - 2 Years               8 - 20 Years  
 2 - 8 Years               20+ Years
- How would you rank your woodworking skills?  
 Simple                   Advanced  
 Intermediate               Master Craftsman
- What stationary woodworking tools do you own?  
Check all that apply.  
 Air Compressor       Panel Saw  
 Band Saw               Planer  
 Drill Press               Power Feeder  
 Drum Sander           Radial Arm Saw  
 Dust Collector           Shaper  
 Spindle Sander           Jointer  
 Table Saw               Lathe  
 Mortiser                 Wide Belt Sander  
 Horiz.Boring Machine  
 Vacuum Veneer Press  
 Other \_\_\_\_\_
- How many of your woodworking machines are Grizzly? \_\_\_\_\_
- Which benchtop tools do you own? Check all that apply.  
 1"x42" Belt Sander       6" - 8" Grinder  
 5" - 8" Drill Press       Mini Lathe  
 8" Table Saw             8" - 10" Bandsaw  
 Scroll Saw               Disc/Belt Sander  
 Spindle/Belt Sander       Mini Jointer  
 10"-12"Thickness Planer  
 Other \_\_\_\_\_
- How many of the machines checked above are Grizzly? \_\_\_\_\_
- Which portable/hand held power tools do you own? Check all that apply.  
 Belt Sander               Orbital Sander  
 Biscuit Joiner           Palm Sander  
 Circular Saw               Portable Planer  
 Detail Sander             Saber Saw  
 Drill/Driver               Reciprocating Saw  
 Miter Saw                 Router  
 Other \_\_\_\_\_
- What machines/supplies would you like Grizzly Industrial to carry?  
\_\_\_\_\_  
\_\_\_\_\_  
\_\_\_\_\_
- What new accessories would you like Grizzly Industrial to carry?  
\_\_\_\_\_  
\_\_\_\_\_  
\_\_\_\_\_
- What other companies do you purchase your tools and supplies from?  
\_\_\_\_\_  
\_\_\_\_\_
- Do you think your purchase represents good value?  
 Yes                       No
- Would you recommend Grizzly to a friend?  
 Yes                       No
- Would you allow us to use your name as a reference for Grizzly customers in your area? **Note: We never use names more than three times.**  
 Yes                       No
- Comments: \_\_\_\_\_  
\_\_\_\_\_  
\_\_\_\_\_

Send a Grizzly Catalog to a friend:

Name_____
Street_____
City_____State_____Zip_____

FOLD ALONG DOTTED LINE

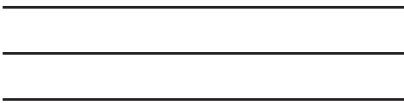

Place  
Stamp  
Here



**GRIZZLY INDUSTRIAL, INC.**  
**P.O. BOX 2069**  
**BELLINGHAM, WA 98227-2069**



TAPE ALONG EDGES--PLEASE DO NOT STAPLE

## Free Manuals Download Website

<http://myh66.com>

<http://usermanuals.us>

<http://www.somanuals.com>

<http://www.4manuals.cc>

<http://www.manual-lib.com>

<http://www.404manual.com>

<http://www.luxmanual.com>

<http://aubethermostatmanual.com>

Golf course search by state

<http://golfingnear.com>

Email search by domain

<http://emailbydomain.com>

Auto manuals search

<http://auto.somanuals.com>

TV manuals search

<http://tv.somanuals.com>