

TEFAL

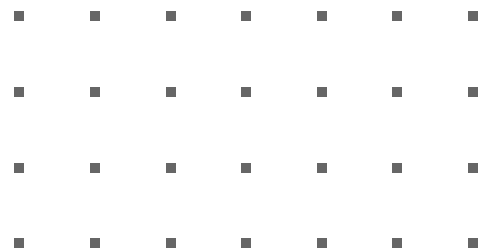

Azura Fryer

Instructions for use



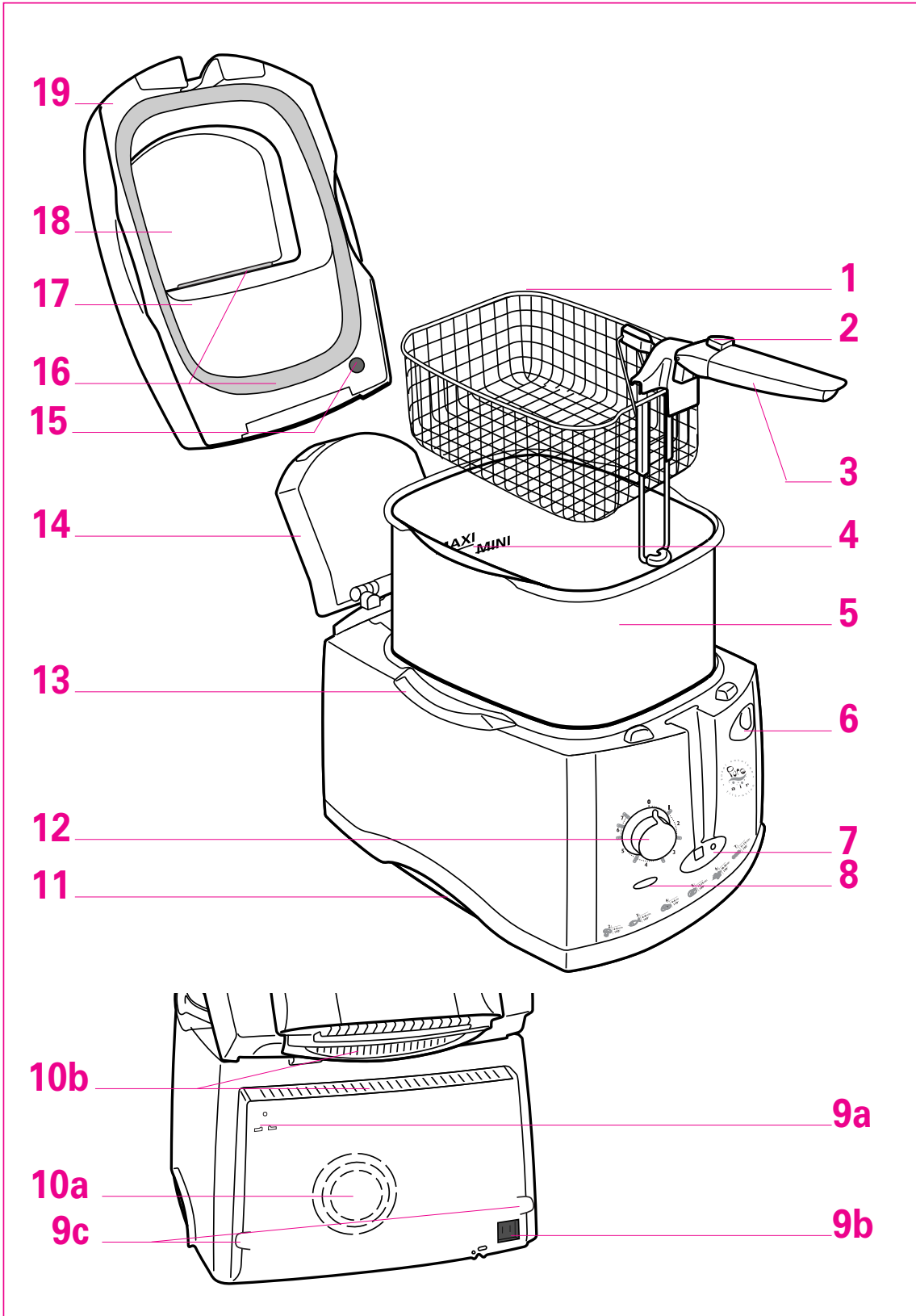

Description

1. Basket
2. Basket locking button
3. Basket "rise and fall" handle
4. Min. and Max. oil level markers
5. Removable bowl with non-stick coating
6. Lid opening button
7. Timer (depending on model)
8. Temperature indicator light
9. Cord set (depending on model)
 - a. Plug seating
 - b. Removable cord
 - c. Cord storage
10. Ventilation for the PURE AIR CATALYSE®
 - a. Air intake
 - b. Air outlets
11. Carrying handles when cold
12. Thermostat/On-off Switch
13. Bowl positioning guide
14. Odour and steam catalysis filter box
15. Lid release button
16. Lid seals
17. Steam guard
18. Viewing window
19. Lid

Protection of the environment

- Your appliance has been designed to work for many years. However, when you finally decide to replace your deep fryer, do not forget to think of what you can do to help to protect the environment by disposing of it at your local waste disposal centre.

Helpline

for any problems or queries please telephone

0845 602 14 54	-	UK (calls charged at local rates)
(01) 412 3000	-	Ireland

Consult our web site	-	www.tefal.co.uk
----------------------	---	--

For UK users only - Wiring instructions

Warning:
this appliance
must be earthed.

Important:
the wires in this cord are
coloured in accordance with
the following codes :
Green and Yellow: Earth
Blue: Neutral
Brown: Live

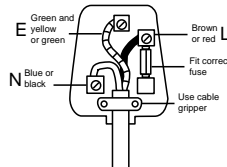

- Connect the Green/Yellow wire to the terminal in the plug marked "E" (or by the earth symbol) or coloured Green or coloured Green and Yellow. Connect the Brown wire to the terminal in the plug marked "L" or coloured Red. Connect the Blue wire to the terminal in the plug marked "N" or coloured Black. A 13 amp fuse should be fitted when the appliance is connected to a BS 1363 plug. Seek professional advice if you are unsure of the correct procedure of the above.

Voltage

- This appliance is designed to work on 230-240 volts AC only. Check that the mains supply corresponds to that shown on the rating plate of the appliance. If the appliance is to be used in any country other than that of purchase, it should be checked by an approved Service Dealer. Standards can vary from country to country.

About your factory fitted plug.

FOR UK ONLY (supplied with certain models only)

- The cord is already fitted with a plug incorporating a 13 amp fuse. If the plug does not fit your socket outlet, see next paragraph.
- Should you need to replace the fuse in the plug supplied, a 13 amp approved BS 1362 fuse must be used.
- The fuse cover is an important part of the plug. Please ensure that it is always refitted. If you lose this cover please do not use the plug. You may contact TEFAL for a replacement.
- If the plug supplied does not fit your socket outlet, it should be removed from the mains lead and disposed of safely. The flexible cord insulation should be stripped back as appropriate and a suitable alternative plug fitted. The replacement plug must be equipped with a 13 amp fuse.

Important:

If the electrical cord of this appliance is damaged, it must only be replaced by an authorised Service Dealer. The safety of this appliance complies with the technical regulations and standards in force.

Safety instructions

- This appliance complies with current safety regulations and requirements as well as directives:
 - 89/336/CEE modified by 93/68/CEE
 - 73/23/CEE modified by 93/68/CEE
- This electrical appliance operates at high temperatures which may cause burns. Despite the high heat protection of the deep fryer, do not touch the apparent metal parts or the window.
- Do not leave the appliance switched on while unattended.
- Use and store it out of children's reach.
- Never insert any object between the removable bowl and the bottom of the appliance.
- Always plug in the appliance at an earthed power socket.
- Do not use an extension lead. If you accept liability for doing so, only use an extension lead which is in good condition, has an earthed plug, and is suited to the power of the appliance.
- Check that the mains voltage corresponds with that shown on the appliance (alternating current only).
- If the appliance is used in a country other than that of purchase, have it checked by an approved Service Centre.
- Never use or plug in your appliance if:
 - its power cord is faulty or damaged,
 - the appliance has been dropped,
 - it has visible damage or operating faults.
 In such cases, to avoid any danger contact your nearest approved Service Centre to have the appliance repaired, as special tools are needed. Never take the appliance apart yourself. This will negate the guarantee.
- If the power cord is damaged, it must be replaced by an authorised service centre, in order to avoid any danger.
- In the event of fire, never try to extinguish the flames with water. Close the lid. Smother the flames with a damp cloth.
- Do not switch on the appliance near to inflammable materials (blinds, curtains, etc.) or close to an external heat source (gas stove, hotplate, etc.)
- This appliance is designed for domestic use only. In the case of professional use, inappropriate use or failure to comply with the instructions, the manufacturer accepts no responsibility and the guarantee does not apply.



EXCLUSIVE PERMANENT FILTERING OF COOKING ODOURS and steam

AZURA is equipped with an exclusive and patented system to ensure optimum filtration of frying odours and steam during cooking: PURE AIR CATALYSE®, a system which requires no handling and is maintenance free.

- This principle of catalysis filtering has been tested and its efficiency during cooking has been acknowledged by independent organizations (CERTECH).
- Its efficiency is constant: no longer any need to change the filter.
- For a maximum reduction of odours, we advise you to:
 - Change the oil or fat regularly (after being used 8 times maximum).
 - Close the lid by pushing on its centre and front parts during preheating and cooling of the oil or fat .
 - Use food oil or fat recommended for frying and respect the cooking temperature indicated by the manufacturer.
 - Except when placing and removing the basket, leave the lid closed.
 - Clean the deep fryer after each use. Azura is MAGICLEAN® (basket, lid and bowl go in the dishwasher).

Preparation for use

Remove the lid

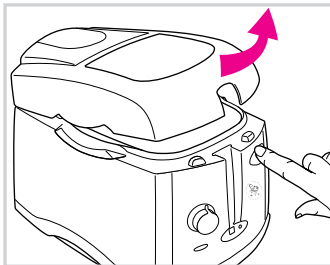

- Open the lid.



The PURE AIR CATALYSE® is not removable. It is permanent.

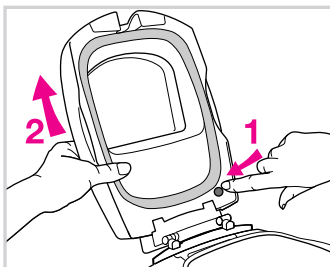

- Push on the release button (1) and lift the lid upwards (2).

Clean the deep fryer

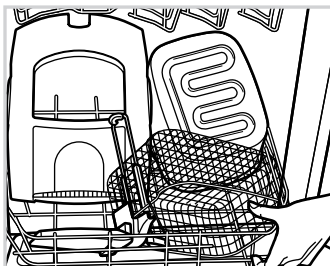

- Clean the lid, the steam guard, the bowl and the basket using a sponge and washing-up liquid or in the dishwasher. Dry.



Do not block the air intake or the air outlet of the ventilation system. Keep them clear and clean.

Preparation

Replacing the lid

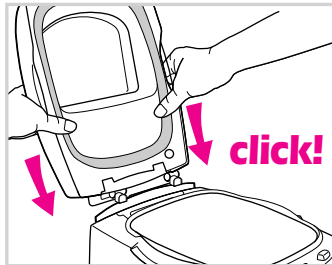

- To replace the lid, place it in the guide rod until you hear the locking "click".

Replacing the removable bowl

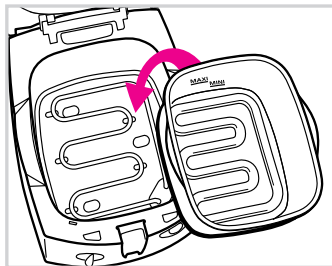

- Insert the bowl, with the Min./Max. markers ($\frac{\text{MAXI}}{\text{MINI}}$) towards the back of the appliance.
- The base of the bowl must fit perfectly onto the element.

! A safety system prevents the deep fryer from working if you have not put the bowl correctly in place.

Filling the bowl

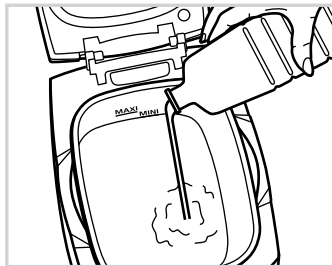



- Use an oil recommended for deep frying: For best results we recommend blended vegetable oil. For sunflower oil, groundnut oil, or soya oil, ensure the oil is changed after every 5 uses.
- If you use **solid vegetable fat**:
 - Cut it into pieces and place it at the bottom of the bowl (**never in the basket**).
 - Never exceed 150° to melt it, then follow the manufacturer's cooking recommendations.
- Lard or dripping should **NOT** be used under any circumstances and may cause overflowing, smoking or risk of fire. For traditional UK style deep fried foods, especially chips, we do not recommend using olive oil.

! Never plug in the deep fryer without oil or fat inside.

! Do not mix different types of oil or fat.

! The oil/fat level must always be between the Min. and Max. markers. Check this each time before cooking, and add some of the same type of oil or fat if necessary.

Oil/Fat quantity		
Azura		
Min.	2 l	1750 g
Max.	2,2 l	2000 g

Preparing the basket

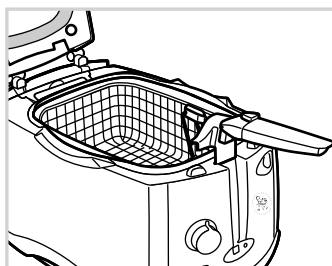

- Place the basket in position on the edge of the bowl.
 - Dry the foods.
 - Fill the basket.
 - Reduce the quantities for frozen foods.
- Cooks tips:**
- Add breaded or delicate foods, either fresh or frozen, after the oil has preheated.

! Never exceed the maximum capacity.



- Cut the foods into like-sized pieces so that they cook evenly,
- Avoid using pieces that are too thick.

Preparation

Oil/Fat quantity		Fresh potato chips	Frozen potato chips
Azura (2,2 l)	Maximum capacity	1000 g	750 g
	Recommended quantity for best results	550 g	400 g



- Shake frozen foods to detach pieces of ice away from the deep fryer.

- Not all frozen foods are ready to use. Check the manufacturer's instructions.

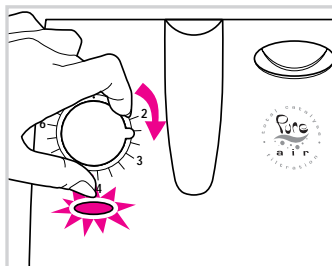

Preheat

- Ensure the fryer has oil inside before switching on.
- Close the lid by pushing on its centre and front parts.
- Plug in the deep fryer.
- Adjust the thermostat (see tables, p. 9). The deep fryer and the ventilation of the PURE AIR CATALYSE® operate, and you will hear the sound of the catalysis filter working.

- ! Place the deep fryer:
 - on a steady surface,
 - out of the reach of children,
 - away from water splashes or heat sources.
- ! Do not leave the deep fryer unattended. Do not let the power cord hang down.

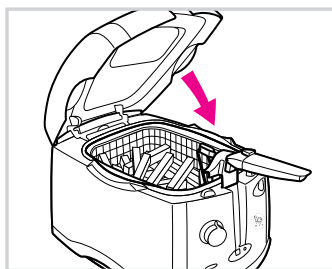

Lowering the basket

- Ensure the lid is closed.
- After the temperature indicator light goes out, press the basket handle locking button (1).
- Fold back the handle slowly (gently lowering the food into the hot oil) until fully in its housing (2).

- ! To reduce the diffusion of odours:
 - do not leave the lid open too long.
 - do not leave the oil to preheat after the indicator light has gone out.
- ! Do not push on the "rise and fall" handle, always press first on the handle's locking button.

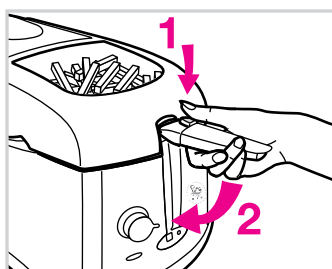

Setting the timer (depending on model)

- Press the button to set the time, minute by minute.
- Release the button. The time displayed is selected and flashes while the countdown begins.
- If you make a mistake, or want to cancel the time selected, press the button for 2 seconds.
- To stop the timer alarm, press the button.

- ! The timer signals that the cooking time is complete, but does not stop the deep fryer.

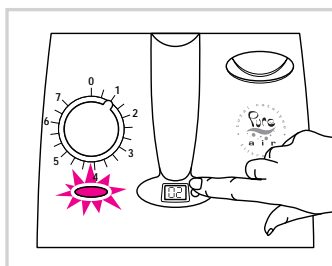

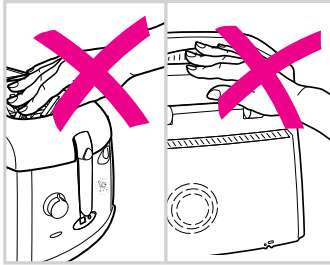

Keeping an eye on the cooking

- During cooking, it is normal for the temperature indicator light to come on and go off during cooking.

! Warning: do not place your hand at the back of the filter. The air vented at the back of the fryer may be hot.

! Do not touch the viewing window, the glass may be hot.



Removing the food

- Lift the handle horizontally to raise the basket until you hear a "click" as it locks.

! Never remove the bowl while the deep fryer is working.

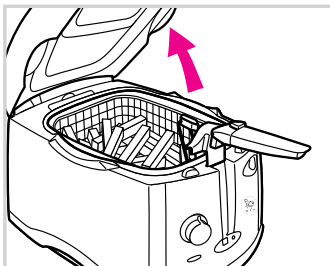

- Open the lid.
- Drain the food.



To prepare to use a second time:
 - wait for the temperature indicator to go out before lowering the foods into the oil.
 - adjust the level with the same type of oil or fat according to the quantity of food to be fried.

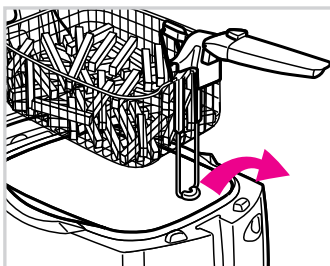

- Remove the basket, making sure that the rod comes completely out of the bowl.
- Serve.



For very crisp fried foods, open the lid as soon as you have finished cooking.

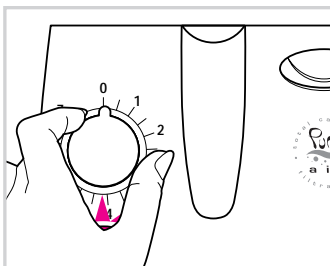

Switching off the deep fryer

- When you have finished frying foods, turn the thermostat/on-off switch to the 0 position.

Add salt and pepper away from the deep fryer to avoid getting into the oil or fat.



- Unplug the deep fryer.
- Leave the deep fryer to cool (1 to 2 hours).
- Only use the carrying handles to move the deep fryer.
- Remove cord or store the cord (depending on model).

! Never move your deep fryer with the lid open.

! Never move your deep fryer with hot oil or fat inside.

Cooking

Cooking tables

The cooking times are given as an indication only. They may vary depending on quantities and personal tastes.

Fresh foods	Temperature	Cooking time
Potato chips (1 kg)	190° C	12 - 15 min.
Potato chips (550 g)	190° C	7 - 9 min.
Breaded Camembert wedges (6 pieces)	190° C	1 - 2 min.
Chicken Kiev* (2 pieces)	180° C	12 - 14 min.
Poultry croquettes (8-10 pieces)	190° C	8 - 9 min.
Scotch Eggs* (2 pieces)	170° C	6 - 8 min.
Apple fritters (4 pieces)	170° C	4 - 6 min.
Ring doughnuts* (4 pieces)	170° C	5 - 7 min.
Stuffed veal escalopes (6-8 pieces)	180° C	10 - 12 min.
Battered cod fillets (2 pieces)	160° C	6 - 8 min.
Fried whitebait (200 g)	160° C	1 - 2 min.
Breaded plaice fillets (1-2 pieces)	160° C	5 - 7 min.
Fried onions rings (6 pieces)	160° C	2 - 3 min.
Fried whole mushrooms (150 g)	150° C	4 - 6 min.
Vegetable fritters (aubergines) (10-12 pieces)	170° C	10 - 11 min.



* = These thicker foods may require turning halfway through cooking to ensure even cooking on both sides.

Cooks tip: When cooking battered food and doughnuts, remove the wire basket to prevent food sticking to it. Take great care when handling the food and use tongs. Gradually place the food in the hot oil, submerging it an inch at a time to prevent it from sinking straight away.

Frozen foods	Cooking time
	Turn thermostat ***
Potato chips (pre-cooked) 750 g	11 - 13 min.
Potato chips (pre-cooked) 400 g	5 - 7 min.
Potato croquettes (8 - 10 pieces)	5 - 6 min.
American style Thin Cut Chips (500 g)	7 - 8 min.
Breaded cod (2 pieces)	5 - 6 min.
Fishcakes in breadcrumbs (8 pieces)	5 - 6 min.
Fish Fingers (6 pieces)	3 - 4 min.
Chicken nuggets (16 pieces)	3 - 4 min.
Large battered cod fillets (2 pieces)	10 - 11 min.
Breaded Scampi (16 pieces)	4 - 5 min.
Breaded Onion Rings (12 pieces)	3 - 4 min.
Breaded Mushrooms (16 pieces)	4 - 5 min.
Smiley Faces (6 pieces)	3 - 4 min.
Alphabites (16 pieces)	3 - 4 min.

Maintenance



PURE AIR CATALYSE®

Patented system of permanent filtering of odour and steam. It is not necessary to change or to clean it.

! Never allow water to get inside the PURE AIR CATALYSE® system.

Storing the oil

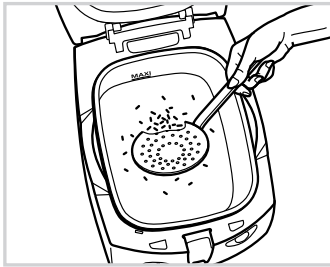

- Turn off the fryer and wait until the oil has completely cooled.
- With a sieve, collect the small pieces of food left in the oil.
- Store the oil in the deep fryer, or store it in an airtight container away from heat and light sources (recommended if you do not use the deep fryer often).

! Do not use any metallic tools.

It is not necessary to store oil in a refrigerator.

Filtering the oil

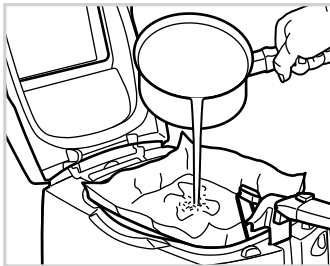

With a filter paper (available from approved Service Centres).

- Wait for the oil to become lukewarm.
- Empty the oil gently into a pan.
- Place a filter paper in the bottom of the basket.
- Clean inside the bowl.
- Place the basket and filter paper into the deep fryer (handle in the upper position).
- Pour the oil carefully back into the bowl, through the filter paper.
- Throw the filter paper away and clean the basket.

! The oil must be filtered regularly.

Crumbs that break away from foods tend to burn and alter the quality of the oil more rapidly. Over time, this increases the risk of catching fire.

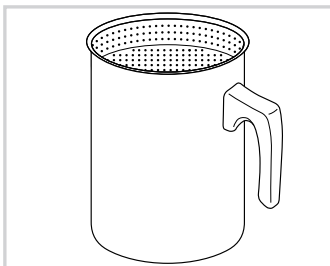

OR

With a filtering container maximum capacity: 2.4 l (available from approved Service Centres).

Changing the oil

- Do not pour used oil into the sink. Leave it to cool and throw it away with the household waste.
- If you add oil, make sure to use the same type.

! Change the oil after being used for a maximum of 8 times.

"Clean" oil keeps the flavour and lightness of foods.

Cleaning



MAGICLEAN® exclusive, very easy to clean: the basket, the lid and the bowl go in the dishwasher. The bowl is removable and non-stick coated.

- Clean the outside of the deep fryer with a damp cloth.
- Dry it carefully.
- Clean the other parts using a damp sponge.

! Never immerse the appliance in water. Do not use aggressive or abrasive cleaning products.

! Check that the air intake and outlet are not clogged.



Cleaning the lid

- To ensure good visibility, clean the viewing window by wiping it with a sponge and lemon juice.
- Allow the window to dry at room temperature or dry with a clean cotton cloth.
- Dry the lid before replacing it.

! Clean the window each time the deep fryer has been used.

! Place the lid at 45° in the dishwasher, window to the top.

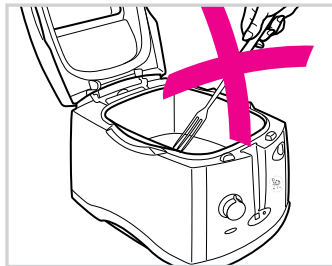

Cleaning the removable bowl

- Browning and scratches that may appear after prolonged use do not cause any problems.
- We confirm that the non-stick coating complies with regulations regarding materials coming into contact with foodstuffs.

! To preserve its non-stick properties longer, do not use any metal tools.

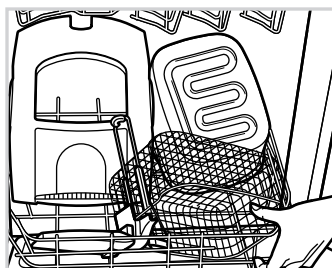

- You can clean your bowl in a dishwasher. Take care not to damage its coating with the dishwasher shelves.
- Try not to damage the shape of your bowl through bumps or being dropped.

! However, if your bowl does become misshapen, have it replaced by your nearest approved Service Centre.

Cleaning the basket

- You can put the basket with the handle in the dish-washer or wash by hand with plenty of hot water and washing up liquid.
- Dry it.

! If your basket is misshapen, have it replaced by your nearest approved Service Centre.

! To avoid a build up of oily residue which can put a strain on the mechanism causing it to break, wash the basket and the handle thoroughly after each use.



If your deep fryer does not work properly

Problem and possible causes	Solutions
<p>The deep fryer does not work.</p> <ul style="list-style-type: none"> The appliance is not plugged in. The thermostat light does not come on. The bowl is the wrong way round. 	<ul style="list-style-type: none"> Plug in the appliance. Set the thermostat to the required temperature and check that the temperature indicator lights up. Replace the bowl the right way round (with the Min./Max. markers towards the back of the appliance).
<p>The deep fryer emits unpleasant odours.</p> <ul style="list-style-type: none"> The lid is open. The lid is not closed properly. The oil has deteriorated. Unsuitable oil has been used. The oil has overflowed and got into the PURE AIR CATALYSE®. The PURE AIR CATALYSE® does not work anymore. 	<ul style="list-style-type: none"> Close the lid. Push on the centre and the front part of the lid to close it. Renew the frying oil (maximum 8 uses). Use a good quality blended vegetable oil/fat. See section below "The oil overflows". Odour and smoke may leak for about 5 minutes. Contact your nearest approved Service Centre
<p>Steam escapes from around the lid.</p> <ul style="list-style-type: none"> The lid is not closed properly. The seal(s) is (are) defective. 	<ul style="list-style-type: none"> Check that the lid is properly locked closed. Contact your nearest approved Service Centre.
<p>The oil overflows.</p> <ul style="list-style-type: none"> The Max. marker for filling the bowl has been exceeded. Overfilling the basket with foods. The basket is misshapen. Mixture of different oils and fats. Not changing the oil often enough. Not drying food before frying. Using the wrong oil. 	<ul style="list-style-type: none"> Check the oil level (Max.), and remove the excess. Check that the basket is not overfilled. Change your basket. Empty and clean the bowl. Refill the bowl with only one type of oil. Lower the basket very slowly. Remove the ice and dry the foods thoroughly. Only use vegetable oil/fat (see p. 6)
<p>The foods do not become golden, and remain soft.</p> <ul style="list-style-type: none"> They are too thick and contain a lot of water. Too much food is being cooked at the same time and the cooking oil is no longer at the right temperature. The frying oil temperature may not be high enough; the thermostat is set incorrectly. 	<ul style="list-style-type: none"> As a test, try a longer cooking time. Dry the food well and cut into thinner pieces. Fry the foods in small quantities (particularly frozen foods). Set the thermostat to the recommended temperature.
<p>The timer no longer works.</p> <ul style="list-style-type: none"> The battery is worn. 	<ul style="list-style-type: none"> Have it replaced at an approved Service Centre.

! Any repairs must only be carried out by an approved Servicing Centre with the manufacturer's own replacement parts.

For any further help and advice, telephone our helpline : 0845 602 1454 (UK-calls charged at local rate) or (01) 412 3000 (Ireland).

Free Manuals Download Website

<http://myh66.com>

<http://usermanuals.us>

<http://www.somanuals.com>

<http://www.4manuals.cc>

<http://www.manual-lib.com>

<http://www.404manual.com>

<http://www.luxmanual.com>

<http://aubethermostatmanual.com>

Golf course search by state

<http://golfingnear.com>

Email search by domain

<http://emailbydomain.com>

Auto manuals search

<http://auto.somanuals.com>

TV manuals search

<http://tv.somanuals.com>