

Tefal®

GB

ULTIMATE AUTOCLEAN®

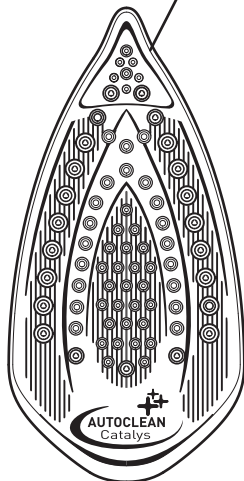
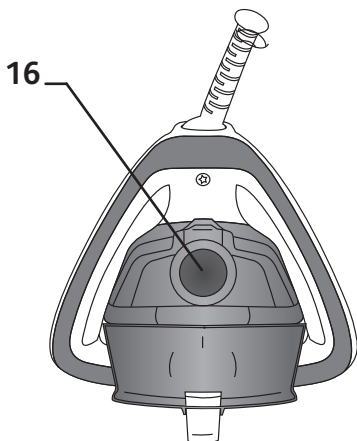
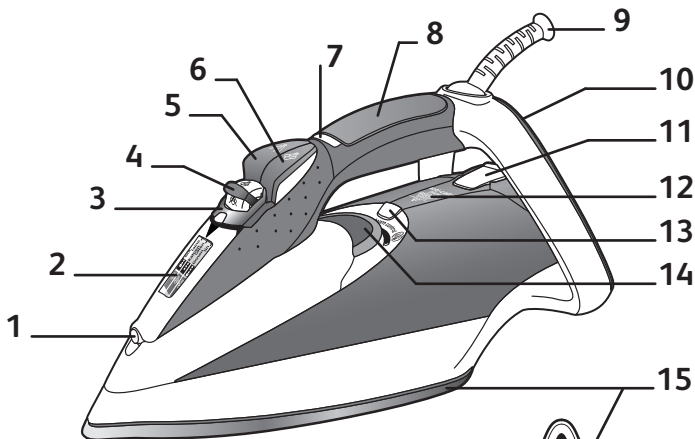



fig.1



fig.2



fig.3



fig.4

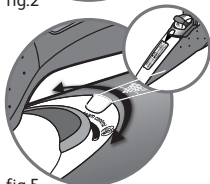

fig.5

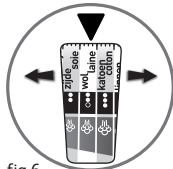

fig.6



fig.7

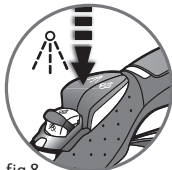

fig.8



fig.9

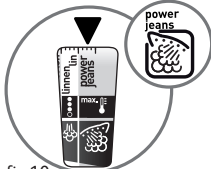

fig.10



fig.11



fig.12



fig.13



fig.14

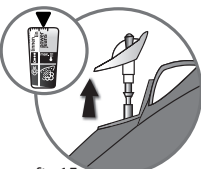

fig.15



fig.16



fig.17

For your safety

This appliance complies with the technical rules and standards for safety currently in force (Electromagnetic Compatibility, Low Voltage, Environnement).

- **Please read these instructions carefully and keep them for future reference.**
- This appliance is not designed to be used by people (including children) with a physical, sensory or mental impairment, or people without knowledge or experience, unless they are supervised or given prior instructions concerning the use of the appliance by someone responsible for their safety. Children must be supervised to ensure that they do not play with the appliance.
- **Warning ! The voltage of your electrical installation must correspond to that of the iron (220V-240V or 127V depending on model). Connecting to the wrong voltage may cause irreversible damage to the iron and will invalidate the guarantee.**
- This iron must always be plugged into an earthed socket. If using a mains extension lead, ensure that it is correctly rated (16A, depending on model), with an earth connection.
- If the electrical cord becomes damaged, it must be immediately replaced by an Approved Service Centre to avoid any danger.
- The appliance should not be used if it has fallen, if it has obvious damage, if it leaks or has functional anomalies. Never dismantle your appliance : have it inspected by an Approved Service Centre, so as to avoid any danger.
- Never immerse your iron in water !
- Do not unplug your appliance by pulling on the cord. Always unplug your appliance: before filling - **fig. 3** or rinsing the reservoir, before cleaning it, after each use.
- Never leave the appliance unattended when it is connected to a power source; if it has not cooled down for approximately 1 hour.
- Your appliance gives off steam, which may cause burns, especially when you are ironing on a corner of your ironing board. Never direct the steam towards people or animals.
- Your iron should be used and placed on a flat, stable, heat-resistant surface. When you put your iron onto its iron rest, make sure that the surface on which you put it is stable.
- This product has been designed for domestic use only. Any commercial use, inappropriate use or failure to comply with the instructions, the manufacturer accepts no responsibility and the guarantee will not apply.

Description

- | | | | |
|---|--|----|------------------------------------|
| 1 | Spray | 9 | Electric power cord |
| 2 | Thermostat indicator | 10 | Extra-large heel with non-slip pad |
| 3 | Antiscale valve grip | 11 | Opening button to water tank |
| 4 | Dry/Steam control | 12 | Integral anti-scale system |
| 5 | Spray Button | 13 | Thermostat indicator light |
| 6 | Shot of Steam Button | 14 | Autosteam Control Thermostat |
| 7 | Auto-Stop safety warning light
(depending on model) | 15 | Autoclean Catalys® Soleplate |
| 8 | Gel comfort handle
(depending on model) | 16 | Water tank filler hole |

Before using for the first time

Warning!

Remove any labels from the soleplate before heating up the iron (depending on model).

Warning! Before using your iron with the steam function for the first time, we recommend

that you operate it in a horizontal position for a few moments, away from your linen, i.e. press the Shot of Steam button a few times.

During the first few uses, a harmless odour and a small amount of smoke may be given off.

This has no effect on the use of the iron and will disappear quickly.

What water to use?

Your appliance has been designed to function with untreated tap water. However, it is necessary to operate the Self-Clean function regularly in order to eliminate hard water deposits from the steam chamber.

If your water is very hard (check with your local water authority), it is possible to mix tap water with store-bought distilled or demineralised water in the following proportions :

- 50% tap water, - 50% distilled or demineralised water.

Types of water not to use?

Heat concentrates the elements contained in water during evaporation. The types of water listed below contain organic waste or mineral elements that can cause spitting, brown staining, or premature wear of the appliance : water from clothes dryers, scented or softened water, water from refrigerators, batteries or air conditioners, pure distilled or demineralised water or rain water should not be used in your Tefal iron. Also do not to use boiled, filtered or bottled water.

Use Steam ironing



1. Filling the water tank

- Unplug your iron before filling it.
- Set the steam control to DRY ☒ - fig. 1.
- Take the iron in one hand and tilt it slightly, so that you can see the water tank filling hole - fig. 3.
- To open the water tank, press the button - fig. 2.
- Fill the water tank - fig. 3 up to the mark "MAX". The mark MAX corresponds to a capacity of 350 cc.
- Close the water tank cover until you hear a click - fig. 4.
- You can now plug in your iron.

2. Choose your ironing programme

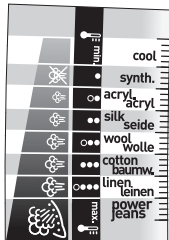
- Your iron has the Autosteam Control function, which recommends 8 different ironing programmes:
- Set the Autosteam Control Thermostat to match the type of textile you wish to iron. Your iron automatically and accurately determines the exact temperature and steam flow that are suitable, in order to guarantee the best results.



- To select the appropriate ironing programme, activate the thermostat located under the handle - **fig. 5**.
- Rotation left : selects the programs requiring low temperature and steam levels.
- Rotation right : selects the programs requiring high temperature and steam levels.
- The program selected appears automatically on the indicator panel at the front of the iron - **fig. 6**.
- Set the steam control to STEAM  - **fig. 1**.
- When your iron reaches the required temperature, the thermostat indicator goes out - **fig. 7**. You can start ironing.

3. Spray Function

- While ironing, press a few times in succession on the Spray button to dampen the fabric - **fig. 8** and iron out awkward creases.

4. For more steam (shot of steam button)

- Press the Shot of Steam button from time to time - **fig. 9**.
- Wait a few seconds between each shot before pressing the button again.

5. Vertical steam ironing

- Ideal for removing creases from suits, jackets, skirts, hanging curtains etc
- Hang the garment on a hanger and hold the fabric slightly taut with one hand. The steam is very hot, so you should always do this with the garment on a hanger – never while someone is wearing it.
- Set your thermostat to MAX - **fig. 10**.
- Press the Shot of Steam button () repeatedly - **fig. 9** moving the iron from top to bottom - **fig. 11**.
- Hold the iron a few centimetres from the fabric to avoid burning delicate fabrics.

6. Anti-Calc Plus System

- Your iron is equipped with an integral anti-scale system - **fig. 12**.
- This system will help to provide :
 - a better ironing quality with a constant flow of steam,
 - a longer life for your iron.

7. Anti-drip function

- Autosteam Control, i.e. the automatic selection of the ironing programme depending on the fabrics elected, makes it possible to reduce steam flow at low temperatures and prevents your iron from dripping water onto your linen.

Recommendations: Fabrics and ironing temperatures:

- Your iron heats up quickly: so begin by ironing fabrics that are ironed at low temperatures first, then go on to those requiring a higher temperature,
- if you change to a program requiring lower temperatures, wait for the thermostat light to come on again before continuing to iron.
- when ironing fabrics with mixed fibres, set the ironing temperature for the most delicate fibre. For delicate fabrics we recommend testing the fabric first on an inconspicuous place eg (inside them).
- For best results we recommend you use a vented ironing board to allow the powerful steam to penetrate through the fabric more efficiently.
- Ensure that the fabric you are ironing is flat to avoid steam venting sideways whilst ironing.

8. Auto-Stop safety feature (depending on model)

- For your safety, the electronic system cuts off the power and **the auto-stop indicator light flashes** - fig. 13 when :
 - The iron remains motionless for more than 8 minutes on its heel.
 - The iron remains flat or on its side for more than 30 seconds.
- To restart the iron, just move it gently until the warning light stops flashing.

When the Auto-Stop warning light is on, it is normal for the thermostat light to remain off.

9. Autoclean Catalys® Soleplate

- Your iron is equipped with a self-cleaning soleplate - fig. 14 which works by catalysis.
- Its exclusive coating helps continuously eliminate all the impurities generated by normal use. It is recommended that you always stand your iron on his heel to preserve its self-cleaning coating.

Dry Ironing

- Choose your ironing program.
- Set the steam control to DRY ☒ - fig. 1.
- You may start ironing when the thermostat light goes out.

Caring for your iron

BE CAREFUL ! Unplug your iron and let it cool down before cleaning it.

Cleaning the anti-calc valve (once per month)

- Unplug your iron and empty the water tank.
- **To remove the antiscal valve, set your thermostat on the position MAX** - fig. 10, **place the steam control on STEAM ☄**, and the valve can now be removed from your iron - fig. 15.

Never touch the end of the valve

- Soak the valve in a cup of white vinegar or plain lemon juice for 4 hours - fig. 16.
- Rinse the valve under running water.
- Replace the anti-calc valve.

The iron will not function without the anti-calc valve

1. Self-cleaning

In order to extend the life of your iron, use the Self-Cleaning function once a month.

- **Set the iron to DRY ☒.**
- Fill the water tank to maximum.
- Set the iron on his heel, with the water tank full, and set the thermostat to MAX - fig. 10.
- When the thermostat light goes out, unplug the iron and hold it in a horizontal position, over a sink.
- Remove the anti-calc valve.

Recommendations: the self-cleaning function helps to slow down the scaling up of your iron.

- Shake the iron gently, over the sink, until some of the water in the water tank (with the impurities) has flowed out through the soleplate.
- At the end of the operation, push the anti-calc valve back into position.
- Turn the iron back on for 2 minutes, setting it on its heel, to dry the soleplate.
- Unplug the iron, and when the soleplate is just warm, wipe it with a soft cloth.

Note!
The steam control position must necessarily be on STEAM  in order to remove or replace the iron's antiscaling rod.

2. Cleaning the soleplate

Your iron is equipped with a self-cleaning soleplate, which works by catalysis.

Its exclusive active coating helps continuously eliminate all the impurities generated by the normal day-to-day use of the iron.

However, if you iron using an unsuitable programme, some traces may be left which require manual cleaning. In this case, it is recommended that you use a soft damp cloth on the warm soleplate, in order not to damage the surface.

Attention!
The use of a scouring pad will cause damage to your soleplate's self-cleaning coating - fig. 17

Storing your iron

- Unplug the iron and wait for the soleplate to cool down.
- Empty the water tank and set the steam control to DRY . A little water may remain in the tank.
- Wind the cord not too tightly around the heel at the back of the iron.
- **Store the iron on its heel.**

Environment



Environment protection first !!

- ① Your appliance contains valuable materials which can be recovered or recycled.
- ➔ Leave it at a local civic waste collection point.

If there is a problem?

Problem	Possible causes	Solutions
<ul style="list-style-type: none"> • Water drips from the holes in the soleplate. 	<ul style="list-style-type: none"> • You are using the Shot of Steam button too often. • You have stored the iron horizontally, without emptying it and without setting it to DRY. 	<ul style="list-style-type: none"> • Wait a few seconds between each use of the button. • See the section "Storing your iron".
<ul style="list-style-type: none"> • Brown streaks come through the holes in the soleplate and stain the linen. 	<ul style="list-style-type: none"> • You are using chemical descaling agents. • You are using pure distilled/demineralised or softened water. • Your linen is not rinsed sufficiently or you have ironed a new garment before washing it. 	<ul style="list-style-type: none"> • Do not add any descaling agents to the water in the water tank. • See section "Types of water not to use?". • See section "Cleaning the soleplate" • Ensure linen is rinsed thoroughly to remove any soap deposits or chemicals on new garments which may be sucked up by the iron.

<ul style="list-style-type: none"> The soleplate is dirty or brown and can stain the linen. 	<ul style="list-style-type: none"> You have ironed with an unsuitable programme (temperature too high). You are using starch. 	<ul style="list-style-type: none"> Select the appropriate program. Refer to the chapter "Clean the soleplate" Spray starch on the underside of the fabric to be ironed.
<ul style="list-style-type: none"> There is little or no steam. 	<ul style="list-style-type: none"> The water tank is empty. The anti-calc valve is dirty. Your iron has a build-up of scale. Your iron has been used dry for too long. 	<ul style="list-style-type: none"> Fill it. Clean the anti-calc valve. Clean the anti-calc valve and carry out a self-clean. Carry out a self-clean. Wait for the soleplate to reach the correct temperature.
<ul style="list-style-type: none"> The soleplate is scratched or damaged. 	<ul style="list-style-type: none"> You have placed your iron flat on a metallic rest-plate or ironed over a zip. You have cleaned your soleplate with an abrasive or metal pad. 	<ul style="list-style-type: none"> Always set your iron on its heel. Try to avoid ironing over zips. Refer to the chapter "Clean the soleplate".
<ul style="list-style-type: none"> Water is leaking out through the water tank cover. 	<ul style="list-style-type: none"> You have not closed the water tank cover properly. 	<ul style="list-style-type: none"> Make sure the water tank cover has clicked shut.
<ul style="list-style-type: none"> Steam or water come from the iron as you finish filling the tank. 	<ul style="list-style-type: none"> The steam control is not set to the DRY position ☒. 	<ul style="list-style-type: none"> Check that the steam control is set to the DRY position ☒.
<ul style="list-style-type: none"> The spray and/or shot of steam do not work. 	<ul style="list-style-type: none"> The water is empty. 	<ul style="list-style-type: none"> Fill the water.
<ul style="list-style-type: none"> Water leaks out of the front of the iron. 	<ul style="list-style-type: none"> You have exceeded the level MAX when filling the water tank. 	<ul style="list-style-type: none"> Empty the surplus water out of the water tank.

If you have any problem or queries, please contact our Customer Relations team first for expert help and advice.

**845 602 1454 - UK
(01) 677 4003 - Ireland**

or consult our website - www.tefal.co.uk

Free Manuals Download Website

<http://myh66.com>

<http://usermanuals.us>

<http://www.somanuals.com>

<http://www.4manuals.cc>

<http://www.manual-lib.com>

<http://www.404manual.com>

<http://www.luxmanual.com>

<http://aubethermostatmanual.com>

Golf course search by state

<http://golfingnear.com>

Email search by domain

<http://emailbydomain.com>

Auto manuals search

<http://auto.somanuals.com>

TV manuals search

<http://tv.somanuals.com>