

Tefal[®]

EXPRESS

GB



www.tefal.com

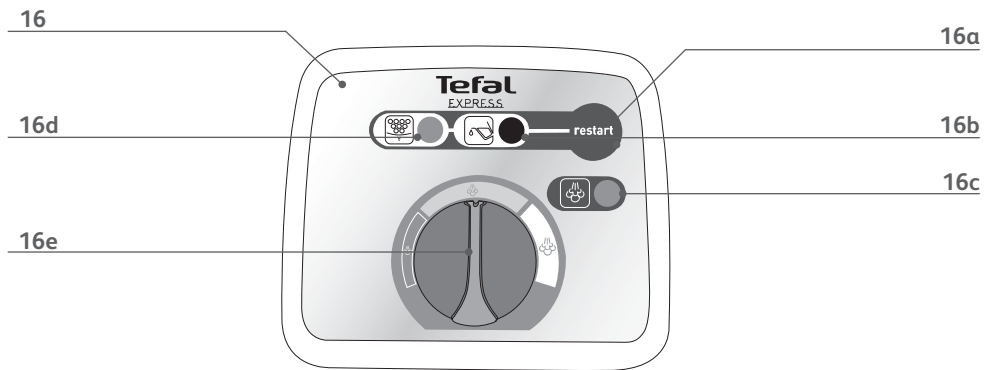
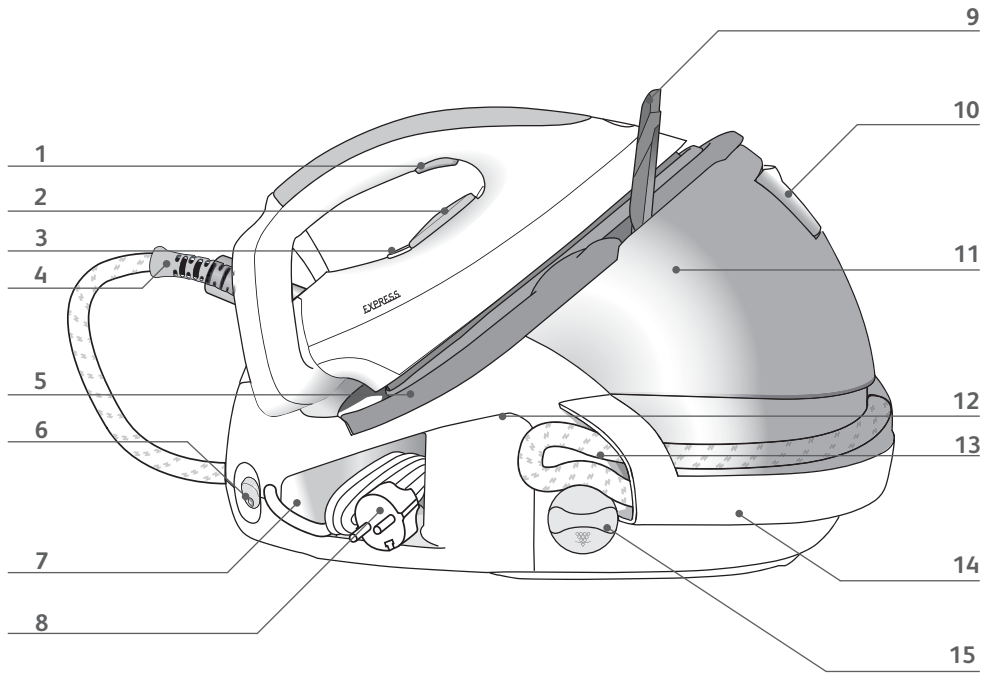

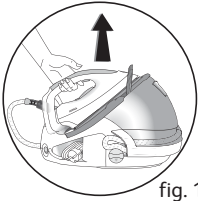

fig. 1

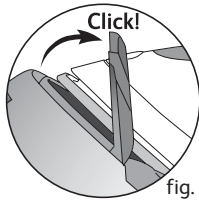

fig. 2

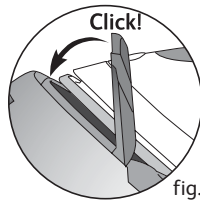

fig. 3

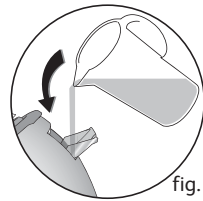

fig. 4

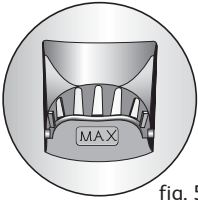

fig. 5

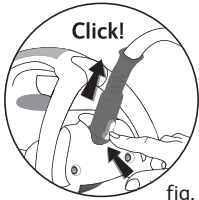

fig. 6

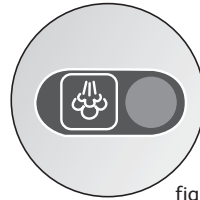

fig. 7



fig. 8

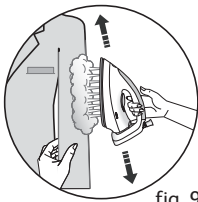

fig. 9

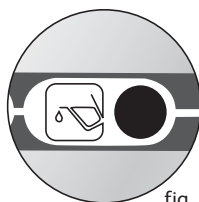

fig. 10

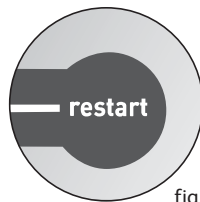

fig. 11

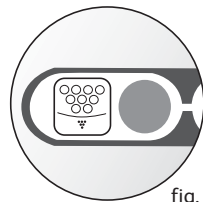

fig. 12

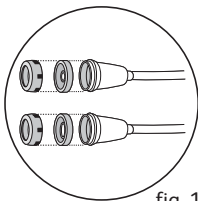

fig. 13

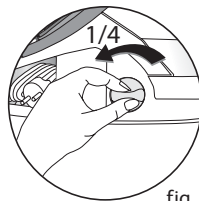

fig. 14

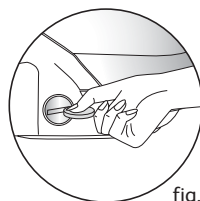

fig. 15

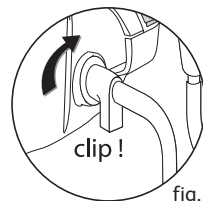

fig. 16

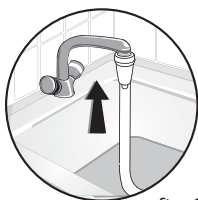

fig. 17

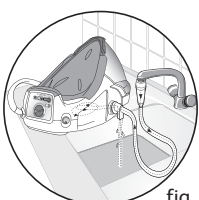

fig. 18

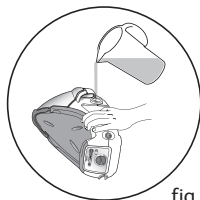

fig. 19

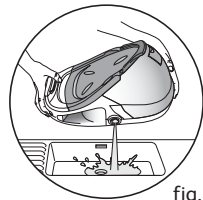

fig. 20

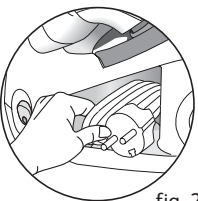

fig. 21

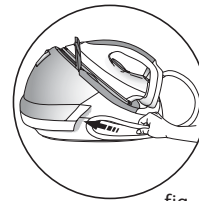

fig. 22

Important recommendations

Safety instructions

- Please read these instructions carefully before first use. This product has been designed for domestic use only. Any commercial use, inappropriate use or failure to comply with the instructions, the manufacturer accepts no responsibility and the guarantee will not apply.
- For your safety, this appliance conforms to the applicable standards and regulations (Low Voltage, Electromagnetic Compatibility, Environmental Directives, as applicable...).
- Your steam generator is an electrical appliance. It should be used under normal conditions. It is intended for domestic use only.
- Your generator is fitted with 2 safety systems:
 - a pressure release valve which, in the event of a malfunction, releases any excess steam;
 - a thermal fuse to prevent the appliance from overheating.
- Always plug your steam generator into:
 - an electrical installation with voltage between 220V and 240V.
 - an earthed socket.

Connecting to the wrong voltage may cause irreparable damage to the appliance and will invalidate your guarantee.

If you are using a mains extension lead, ensure that it is correctly rated (10A) with an earth, and is fully extended.
- Completely unwind the power cord from its storage space before connecting to an earthed socket.
- If the electric power cord or the iron-unit is damaged, it must be replaced by an Approved Service Centre in order to prevent any danger.
- Do not unplug the appliance by pulling on the cord.
Always unplug your appliance:
 - before rinsing out the boiler or before filling the water tank,
 - before cleaning your generator,
 - after each use.
- The appliance must be used and placed on a flat, stable, heat-resistant surface. When you place the iron on the iron rest, make sure that the surface on which you place it is stable.
- This appliance is not intended for use by persons (including children) with reduced physical, sensory or mental capabilities, or lack of experience and knowledge, unless they have been given supervision or instruction concerning use of the appliance by a person responsible for their safety.
- Children should be supervised to ensure that they do not play with the appliance.
- Never leave the appliance unattended :
 - when it is connected to the mains,
 - until it has cooled down (around 1 hour).
- The soleplate and generator iron-rest can become very hot and cause burns: never touch these parts. Never touch the electric cords with the soleplate of the iron.
- Your appliance gives off steam which can cause burns. Handle your iron carefully, particularly when using the vertical steam function. Never direct the steam towards persons or animals.
- Before unscrewing the boiler rinse cap, wait until the generator is cold (unplugged for more than 2 hours).
- While rinsing out the boiler, never fill it directly under the tap.
- If you lose or damage the boiler rinse cap, have it replaced by an approved Service Centre.
- Never immerse your steam generator in water or any other liquid. Never hold it under the water tap.
- The appliance must not be used if it has fallen to the floor, shows evidence of damage, leaks or fails to function correctly. Never dismantle your appliance. To avoid any danger, have it inspected in an approved service centre.
- This appliance has been designed for domestic use only. Any commercial use, inappropriate use or failure to comply with the instructions, the manufacturer accepts no responsibility and the guarantee will not apply.

Description

1. Steam control button
2. Iron temperature adjustment button
3. Iron thermostat light
4. Easycord system (depending on model)
5. Iron rest
6. Illuminated on / off switch
7. Power cord storage space
8. Power cord
9. Lock-System hoop (depending on model)
10. Water tank filler cover
11. Water tank
12. Steam generator boiler (in the base unit)
13. Iron-base steam cord
14. Slide storage place for the steam cord
15. a - Boiler rinse cap cover
b - Boiler rinse cap
16. Control panel
a - Restart button
b - "Water tank empty" light
c - "Steam ready" light
d - "Boiler rinse" light
e - Steam output control dial

Locking system for retaining the iron on the base - Lock-system (depending on model)

Your steam generator is equipped with a retaining clip which locks the iron on its casing for easier transport and storage – fig.1:

- Locking – fig.2
- Unlocking – fig.3

To carry your steam generator by the iron handle:

- place the iron on the iron rest of the generator and raise the retaining hoop over the iron until it locks into place (audible click) – fig.2
- grasp the handle of the iron to carry your steam generator – fig.1

Preparation

Due to the powerful steam output, a mesh type ironing board must be used to allow any excess steam to escape and to avoid steam venting sideways.

What water may be used ?

- Your iron has been designed to operate using untreated tap water.
- Heat concentrates the elements contained in water during evaporation. The types of water listed below contain organic waste or mineral elements that can cause spitting, brown staining or premature wear of the appliance: water from clothes dryers, scented or softened water, water from refrigerators, batteries or air conditioners, pure distilled or demineralised water or rain water should not be used in your iron. Also do not use boiled, filtered or bottled water.

If your water is very hard (check with your local water authority) it is possible to mix untreated tap water with store-bought distilled or demineralised water in the following proportions : 50% untreated tap water, 50% distilled or demineralised water.

Filling the water tank

- Place your steam generator on a stable, horizontal heat-resistant surface.
- Ensure that your steam generator is unplugged and that the soleplate and the iron rest have cooled down.
- Open the water tank filler cover – fig.4.
- Pour in untreated tap water up to the max mark – fig.5.
- Close the water tank filler cover.

Using the Easycord system (according to model)

- Your iron is equipped with an extension cord system to prevent the cord from dragging over the laundry and creasing it again when ironing.
- Take the steam cord out of its housing and unwind it completely.
- Remove the tie to release the cord outlet.
- Press the Eject button – fig.6 and the Easycord system extends automatically.
- When the cord outlet tips, the Easycord system extends automatically without you having to press the Eject button.

Using your steam generator

The first time the appliance is used, there may be some fumes and smell but this is not harmful. They will not affect use and will disappear rapidly.

- Completely unwind the power cord and the steam cord from its storage space.
 - Lower the retaining hoop (depending on model) to unlock the safety catch – fig.3.
 - Plug in your steam generator to an earthed socket.
 - Press on the on / off switch. The green light (located on the control panel) flashes and the boiler heats up – fig.7.
- When the green “steam ready” light stops flashing (after 2 minutes approximately), the appliance is ready.

Operating the control panel

- Green light flashes: the boiler heats up. – fig.7.
- Green light on: the steam is ready – fig.7.
- Red light “water tank” on: the water tank is empty – fig.10.
- Orange light “boiler rinse” flashes: rinse the boiler – fig.12.

Use



Steam ironing

- Place the iron's temperature control slide according to the type of fabric to be ironed (see table below).
- The thermostat light comes on. Be careful ! The steam generator is ready when the thermostat light goes out and when the green “steam ready” light stays on.
- Adjust the steam output control dial (located on the control panel).
- While ironing, the light on top of the iron and the steam ready light turn on and off, as the temperature adjusts without interrupting ironing.
- To obtain steam, press on the steam control button under the iron handle and keep it pressed – fig.8. The steam will stop when you release the button.
- When starting, and regularly while it is being used, your steam generator's electric pump injects water into the boiler. It makes a noise but this is quite normal. You may also hear a clicking noise which is the steam valve opening. Again this is normal.
- Always spray starch onto the reverse side of the fabric to be ironed.

Do not place the iron on a metal support. When taking a break from ironing, always place the iron on the iron rest plate of the unit. It is equipped with non-slip pads and has been designed to withstand high temperatures.

Setting the temperature

SETTING THE TEMPERATURE AND STEAM OUTPUT ACCORDING TO TYPE OF FABRIC TO BE IRONED:

TYPE OF FABRICS	SETTING TEMPERATURE CONTROL	SETTING STEAM OUTPUT CONTROL DIAL
Linen, cotton	●●●	
Silk, Wool	●●	
Synthetics (polyester, acetate, acrylic, polyamide)	●	

To prime the steam circuit, either before using the iron for the first time, or if you have not used the steam function for a few minutes, press the steam control button several times in a row, holding the iron away from your clothes. This will enable any cold water to be ejected from the steam circuit.

- **Iron temperature setting:**

- Start with the fabrics to be ironed at a low temperature (●) and finish with those which need higher temperatures (●●● or Max).
- Mixed fibre fabric: set the ironing temperature to the setting for the most delicate fabric.
- Woollen garments: press repeatedly on the steam control button – fig.8 to obtain short bursts of steam, without placing the iron on the garment itself.

- **Steam output setting:**

- Thick fabric: increase the steam setting.
- At a low temperature : set the steam output control dial to the low position.

Dry ironing

- Do not press the steam control button under the iron handle.

Vertical steam ironing

- Set the iron temperature control slide and the steam output control dial (located on the control panel) to the MAX position.
- Hang the garment on a coat hanger and hold the fabric slightly taut with one hand.

As steam is very hot : never attempt to remove creases from a garment while it is being worn, always hang garments on a coat hanger.

- Holding the iron in a vertical position, tilted slightly forwards, press repeatedly on the steam control button (underneath the iron handle) moving the iron from top to bottom – fig.9.

Recommendations : for fabrics other than linen or cotton, hold the iron a few centimetres from the garment to avoid burning the fabric.

Refilling the water tank

When the red “tank empty” indicator light turns on, there is no more steam – fig.10. The water tank is empty.

- Unplug the generator. Open the water tank filler cover. – fig.4. Fill the water tank up without exceeding the MAX level – fig.5.
- Close the water tank filler cover.
- Replug the generator. Press the “restart” button on the control panel – fig.11. to continue ironing. When the green light stops flashing, the steam is ready.

Maintenance and cleaning

Cleaning your generator

- Do not use detergent or descaling products for cleaning the soleplate base-unit.
- Never hold the iron or the base unit under the tap.
- Empty and rinse the removable water tank
- Regularly clean the soleplate with a damp, non-metallic washing up pad.
- Clean the plastic parts of the appliance occasionally with a soft cloth.

Before cleaning, ensure your steam generator is unplugged and that the soleplate and the iron have cooled down.

Rinsing the boiler

- To extend the efficient operating life of your boiler and avoid scale particles on your linen, your generator is equipped with an orange “boiler rinse” warning light that flashes on the control panel after about 10 uses – **fig.12**.
- If the orange “boiler rinse” warning light flashes, you can continue ironing normally but remember to rinse the boiler first, the next time that you use it.
- **Before proceeding, check that the generator is cool and unplugged for more than 2 hours.**

Caution! Above all, you must not use descaling products to rinse the boiler: they may damage it. Before cleaning or emptying your generator, it is imperative that you leave it to cool for more than 2 hours, to prevent any risk of burns.

with the rinsing accessory

- Use the accessory provided with the packaged product. It will make it easier to rinse the boiler as the generator will need less handling.
- Your rinsing accessory has been designed to work on a wide range of taps. Choose the seal (a or b) – **fig.13**. that is best suited to your tap.
- Place your steam generator on the edge of your sink, with the iron to one side, standing on its heel.
- Unscrew anti-clockwise a quarter of a turn the boiler rinse cap cover – **fig.14**.
- Using a coin, gently unscrew the boiler rinse cap – **fig.15**.
- Place the plastic nozzle of the rinsing pipe into the hole of the boiler and turn gently to the right until it locks. The outlet of this nozzle must be positioned over the sink – **fig.16**.
- Attach the other end of the rinsing accessory to your untreated tap – **fig.17**.
- Turn the tap on gently and gradually and let cold water run through the rinsing pipe into the sink for about 1 minute – **fig.18**.
- Switch off the tap and remove the rinsing pipe.
- Screw back and tighten up the boiler rinse cap with a coin.
- Put the boiler rinse cap cover back in place.
- **The next time you use the generator, hold down the “restart” button to turn off the orange light – fig.11. .**

OR

without the rinsing accessory

- Place your steam generator on the edge of your sink, with the iron to one side, standing on its heel.
- Unscrew anti-clockwise a quarter of a turn the boiler rinse cap cover – **fig.14**.
- Using a coin, gently unscrew the boiler rinse cap – **fig.15**.
- Holding your steam generator in a tilted position, and using a jug, fill the boiler with 1/4 litre of tap water – **fig.19**.
- Shake the base unit for a few moments and then empty it completely into your sink – **fig.20**.
To obtain the best result, we recommend that this operation is done twice.
- Screw back and tighten up the boiler rinse cap with a coin.
- Put the boiler rinse cap cover back in place.
- **The next time you use the generator, hold down the “restart” button to turn off the orange light – fig.11.**

Storing your generator

- Press the illuminated on/off switch and unplug the generator. Store the electrical cord in its storage place – **fig.21**.
- Raise the retaining hoop over the iron until it locks into place (audible click) – **fig.2**.
- Your iron is then safely retained on its base. Warning: do not touch the soleplate while still hot.
- Slot the extension cord outlet in the notch (depending on model). Take the end of the cord support and press to return the flexible part into the base.
- Store the steam cord in its slide storage place. Take it, fold it in two so as to make a loop. Put the end of this loop in the slide storage place then push gently until you see the end on the other side of the slide storage place – **fig.22**.
- Leave the iron (and the iron rest) to cool down for 30 minutes.
- You can then put your steam generator away, carrying it by the handle – **fig.1**.

A problem with your generator ?

PROBLEMS	CAUSES	SOLUTIONS
The generator does not come on and the thermostat light and the on/off switch are not illuminated.	The appliance is not switched on.	Check that your appliance is correctly plugged in and press the illuminated on/off switch.
Water runs out of the holes in the soleplate.	Water has condensed in the pipes because you are using steam for the first time or you have not used it for some time.	Press on the steam control button away from your ironing board until the iron produces steam.
	The soleplate is not hot enough.	Decrease the steam output while ironing at low temperature (steam output control dial on the control panel). Wait for the thermostat light to go out before activating the steam control button.
	Your thermostat is faulty: the iron is not hot enough.	Contact an Approved Service Centre.
Water streaks appear on the linen.	Your ironing board is saturated with water because it is not suitable for use with a steam generator.	Check that your ironing board is suitable (see page 5).
White streaks come through the holes in the soleplate.	Your boiler has a build-up of scale because it has not been rinsed out regularly.	Rinse out the boiler.
Brown streaks come through the holes in the soleplate and stain the linen.	You are using chemical descaling agents or additives in the water for ironing.	Never add this type of product in the water tank or in the boiler (see page 5 for what water may be used). Contact an Approved Service Centre.
	Fabric fibres have accumulated in the holes of the soleplate and are burning.	Clean the soleplate with a non-metallic sponge.
	Your linen is not rinsed sufficiently or you have ironed a new garment before washing it.	Ensure linen is rinsed thoroughly to remove any soap deposits or chemicals on new garments which may be sucked up by the iron.
The soleplate is dirty or brown and may stain the linen.	You are ironing at too high a temperature.	See our recommendations regarding temperature control setting.
	You are using starch.	Always spray starch on the reverse side of the fabric to be ironed.

There is no steam or there is little steam.	The water tank is empty (red light on).	Fill the water tank.
	The steam output control dial is set at minimum.	Increase the steam output (control dial on the control panel).
	The soleplate temperature is set to the maximum.	The generator is working but steam is very hot and dry As a consequence, it is less visible.
The red "water tank empty" light is on.	The water tank is empty.	Fill the water tank.
Steam escapes from the rinse plug.	The rinse plug has not been tightened correctly.	Tighten the rinse plug correctly.
	The rinse plug seal is damaged.	Contact an Approved Service Centre to order a new rinse plug seal.
Steam or water escapes under the appliance.	The generator is faulty.	Stop using the generator and contact an Approved Service Centre.

Environment protection first !

- ① Your appliance contains valuable materials which can be recovered or recycled.
- ➡ Leave it at a civic waste disposal centre.



If you have any problems or queries please call our Customer Relations team first for expert help and advice: 0845 602 1454 - UK
(01) 461 0390 - Ireland
or consult our website - www.tefal.co.uk

05/07 - 021482

Free Manuals Download Website

<http://myh66.com>

<http://usermanuals.us>

<http://www.somanuals.com>

<http://www.4manuals.cc>

<http://www.manual-lib.com>

<http://www.404manual.com>

<http://www.luxmanual.com>

<http://aubethermostatmanual.com>

Golf course search by state

<http://golfingnear.com>

Email search by domain

<http://emailbydomain.com>

Auto manuals search

<http://auto.somanuals.com>

TV manuals search

<http://tv.somanuals.com>