

**COLOR
TELEVISION**

**AMIRA 15
LCD 38-6605 BS**

**AMIRA 17
LW 45-6605 BS**

**AMIRA 20
LCD 51-6605 BS**

**DEUTSCH
ENGLISH
FRANÇAIS
ITALIANO
NEDERLANDS
TÜRKÇE
POLSKI**

GERUNDIG

CONTENTS

3-4	Set-up and safety
5-6	Connection/Preparation
5-6	Connecting the antenna and the mains cable
6	Adjusting the inclination of the screen
7-9	Overview
7	Operating controls on the television
7	Connections on the television
8-9	The remote control
10-13	Settings
10	Setting television channels automatically
10-11	Changing stored channels
12	Picture settings
12-13	Audio settings
14-15	Television operation
14	Basic functions
15	Changing the picture format
15	Zap function
16-17	Teletext mode
16	TOP text or FLOF text mode
16	Normal text mode
16-17	Additional functions
18	Convenience functions
18	Convenience functions with the »FEATURES« menu
19-21	Using external devices
19	Video recorder, DVD player or SET-TOP box
20	Decoder or satellite receiver
20	Headphones
21	Camcorder
21	HiFi system
22	Operation as a PC Monitor
22	Connecting a PC
22	Selecting the channel position for the PC
22	Settings for the PC
23-25	Special settings
23-25	Setting television channels
26-28	Information
26	Technical data,
26	Service information for dealers
26	Environmental note
27	Troubleshooting
28	Additional Information for units sold in the UK.

SET-UP AND SAFETY

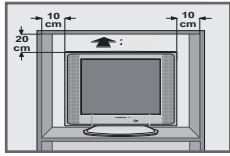

Please note the following information when setting up your television set.

This television set is designed to receive and display video and audio signals.

Any other use is expressly prohibited.

The ideal viewing distance is 5 times the screen diagonal.

External light falling on the screen impairs picture quality.

Ensure sufficient clearance between the TV and the wall cabinet.

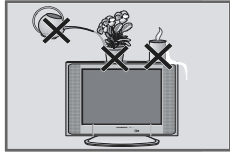

The television set is designed for use in dry rooms. If you do use it in the open, please ensure that it is protected from moisture, such as rain or splashing water. Do not expose the television set to any moisture.

Do not place any vessels such as vases on the television, as they may spill liquid, thus presenting a safety risk.

Place the television set on a solid, level surface. Do not place any objects such as newspapers on the television set or cloth or similar items beneath it.

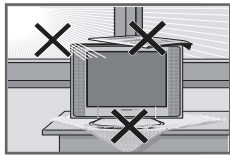

Do not place the television set close to heating units or in direct sunlight, as this will impair cooling.

Heat build-up can be dangerous and shortens the operating life of the television set. For reasons of safety, have a specialist remove any dirt deposits in the set from time to time.

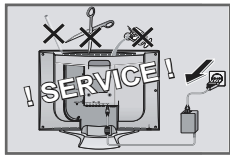

Do not open the television set under any circumstances. Warranty claims are excluded for damage resulting from improper handling.

Ensure that the mains cable and the mains adapter are not damaged.

The television set may only be operated with the mains cable/adaptor supplied.

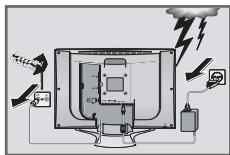

Thunderstorms are a danger to all electrical devices. Even if the television set is switched off, it can be damaged by a lightning strike to the mains or the antenna cable. Always disconnect the mains and antenna plugs during a storm.

Clean the screen with a soft, damp cloth. Only use plain water.

Note:

Do not connect any other equipment while the device is switched on. Switch off the other equipment as well before connecting it.

Only plug the device into the mains socket after you have connected the external devices and the antenna.

SET-UP AND SAFETY

Please note when deciding where to put the device that furniture surfaces are covered by various types of lacquer and plastic, most of which contain chemical additives. These may cause corrosion to the feet of the device, thus resulting in stains on the surface of the furniture which can be difficult or impossible to remove.

The screen of your LCD television meets the highest quality standards and has been checked for pixel faults.

Despite the great care taken in manufacturing, technological reasons make it impossible to completely discount the possibility that some pixels may be faulty.

Provided they are within the thresholds specified by the DIN norm, pixel faults of this kind cannot be regarded as a defect as defined by the warranty.

CONNECTION/PREPARATION

Connecting the antenna and the mains cable

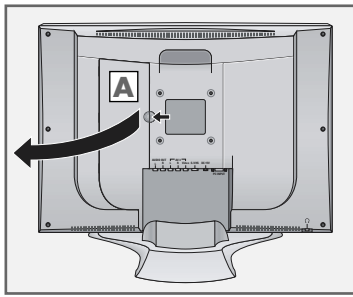

- 1 Take off the cover (A).
- 2 Plug the antenna cable of the rooftop antenna into the »ANT IN« antenna socket on the television.
- 3 Plug the mains cable supplied into the mains socket of the power unit.
- 4 Plug the power pack into the »DC 12 V« socket (Amira 15 and Amira 17) or the »DC 15 V« socket (Amira 20) on the television.
- 5 Plug the power cord plug into an earthed safety socket.

Note:

Only connect the television using the power cord supplied to a suitable earthed safety socket.

Do not use an adapter plug or extension lead which does not meet the applicable safety standards. Do not tamper with the power cord.

Only plug the device into the mains socket after you have connected the external devices and the antenna.

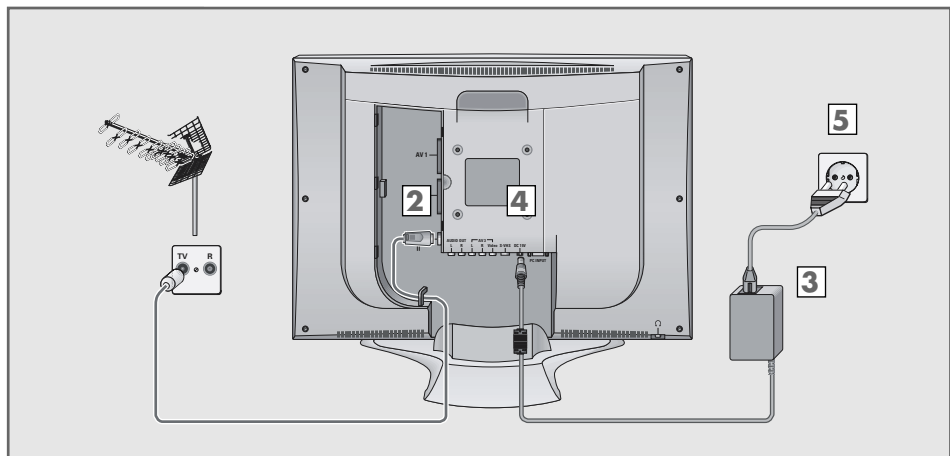

- 6 Put on the cover (A).

CONNECTION/PREPARATION

Inserting batteries in the remote control

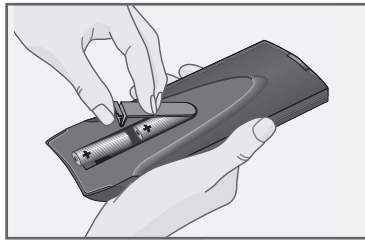

- 1 Open the battery compartment by removing the lid.
- 2 Insert the batteries (Mignon type, for example UM-3 or AA, 2x1,5V). Observe the polarity (marked on the base of the battery compartment).
- 3 Close the battery compartment.

Note:

If the television no longer reacts properly to remote control commands, the batteries may be flat. Be sure to remove used batteries.

The manufacturer accepts no liability for damage resulting from used batteries.

Environmental note

Batteries, including those which contain no heavy metal, may not be disposed of with household waste. Please dispose of used batteries in an environmentally sound manner. Find out about the legal regulations which apply in your area.

Adjusting the inclination of the screen

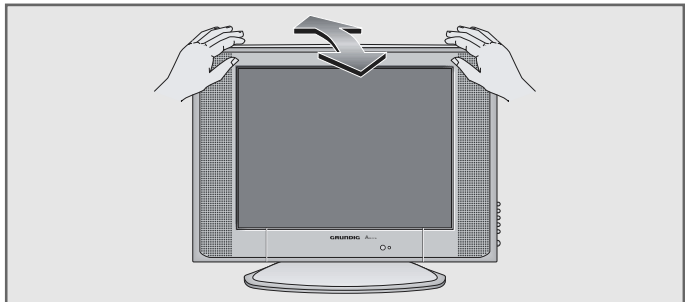

- 1 Hold the television stand.
- 2 Carefully tilt the screen forward or back.

OVERVIEW

Controls on the television

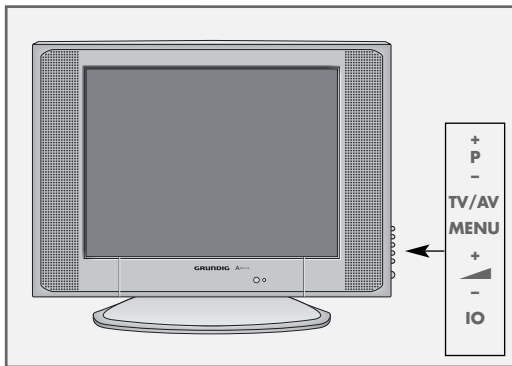

- Operation indicator.
- + P - Switches the television on from standby;
Channel selection.
- TV/AV** Selects the AV channels and the most recently viewed television channel.
- MENU** Opens the »INFO« menu.
- + ▴ - Adjusts the volume.
- ▾
- IO** Switches the television into and out of standby mode.

Connections on the television set

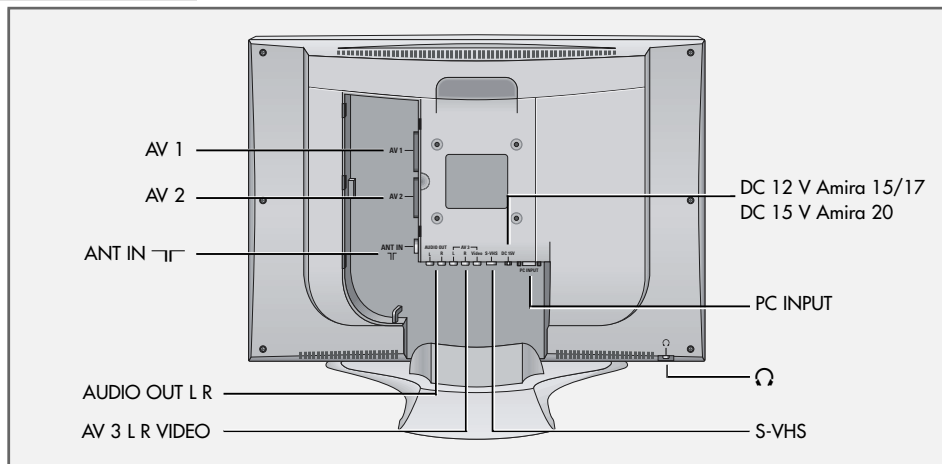

- AV 1** Euro/AV socket (FBAS, RGB).
- AV 2** Euro/AV (FBAS) socket – Amira 17/20 only.
- ANT IN** Antenna socket.
- AUDIO OUT L R** Audio output.
- AV 3 L R VIDEO** Audio/video input.
- S-VHS** S-VHS video input.
- Headphone connection (3.5 mm ø jack).
- PC INPUT** VGA connection for PC.
- DC 12 V** Power pack connection socket (Amira 15/17).
- DC 15 V** Power pack connection socket (Amira 20).

OVERVIEW

The remote control



Switches off the television set (stand-by).

PIP

Key has no function.



Switches between picture formats.



Switches to the PC channel position;
switches to double character size in teletext mode.

1...0

Switches the television on from standby mode;
selects channels directly.



Sound on/off (mute).

i

Opens and closes the »INFO« menu;
closes all menus.

Z

Zap function.

P+, P-

Switches the television on from standby;
selects stations step by step;
moves the cursor in the menus up and down.



Adjusts the volume;
moves the cursor left/right.

OK

Calls up the preset channels;
activates various functions.

TXT

Switches between teletext and TV modes.

AV

Selects the AV channels and the most recently viewed
television channel.

SCAN

Reveals answers in teletext mode.

PAP

Page stop in teletext mode.

SIZE

Selects the sub-pages in teletext mode.

POS

Updates a page in teletext mode.

OVERVIEW



Selects various picture settings;
scrolls back a page in teletext mode



Time on;
scrolls to the next page in teletext mode.



Selects the desired chapter in teletext mode.



Selects various audio settings[∞]
selects the desired topic in teletext mode.

VCR, SAT DVD

Switches to operating a GRUNDIG video recorder, a GRUNDIG satellite receiver or a GRUNDIG DVD player.

Keep the relevant buttons (»VCR«, »SAT«, »DVD«) pressed down. Then press the button you require.

Note:

The functions available to you depend on the model of the device you are using.
Just try it out.

SETTINGS

Setting television channels automatically

The television set is equipped with an automatic channel search system.

You start the search and can then sort the television channels into your order of preference.

99 preset positions are provided, to which you can assign television channels from the antenna or from the cable connection.

- 1 Switch on the television with »**IO**« on the television set, then press »**P+**« on the remote control.

– The »**SPRACHE**« (LANGUAGE) menu appears when the television is first switched on.

Hint:

If the »**SPRACHE**« (LANGUAGE) menu does not appear on the screen, then set it in accordance with the chapter on resetting all television channels on page 25.

- 2 Select language with »**P+**«, »**P-**«, »**◀**« or »**▶**« and press »**OK**« to confirm.

– The »**COUNTRY SELECTION**« menu appears.

- 3 Press »**P+**«, »**P-**«, »**◀**« or »**▶**« to select the country and »**OK**« to confirm.

– A warning message appears.

- 4 Press »**OK**« to start the search.

– The search begins. It may last a few minutes, depending on the number of television stations found.

– After the search the television switches to channel position 1 and the »**PROGRAM TABLE**« menu appears.

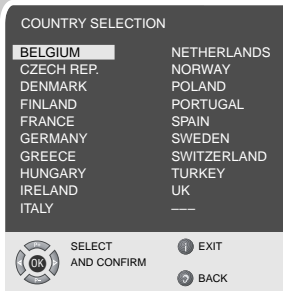

Changing stored channels

You can delete channels that have been stored more than once during the automatic search. You can also store channels in a different preset position, change or enter the name of a channel as well as skip channels.

Selecting the station list

- 1 Press »**i**« to open the »**INFO**« menu.

– The »**INFO**« menu appears.

- 2 Select »**SETUP**« with »**P+**« or »**P-**« and confirm with »**OK**«.

– The »**SETUP**« menu appears.

- 3 Select »**PROGRAM TABLE**« with »**P+**« or »**P-**« and confirm with »**OK**«.

Note:

Further operation is explained in the following sections.



SETTINGS



Deleting channels

- 1 In the »PROGRAM TABLE« menu, select the station to be deleted with »P+«, »P-«, »◀« or »▶«.
- 2 Press »OK« (yellow) to delete the channel.

Note:

To delete other stations, repeat steps 1 and 2.

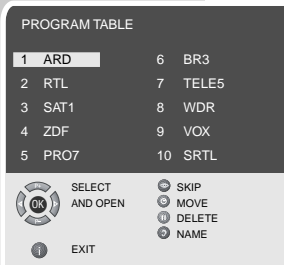

Sorting television channels

- 1 In the »PROGRAM TABLE« menu, select the channel to be moved with »P+«, »P-«, »◀« or »▶«.
- 2 Highlight the channel with »↻« (green).
- 3 Select a new channel position by pressing »P+«, »P-«, »◀« or »▶« and then press »↻« to confirm.
– All of the channels that follow move up one position.

Note:

To sort the other television channels repeat steps 1 to 3.

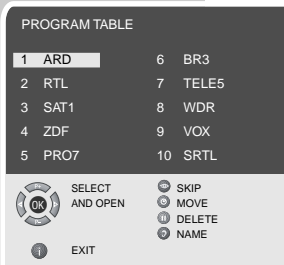

Entering the channel names (maximum of 5 characters)

- 1 In the »PROGRAM TABLE« menu, select the desired channel with »P+«, »P-«, »◀« or »▶«.
- 2 Highlight the channel with »↻« (blue).
- 3 Select letters or numbers with »P+« or »P-«, move to the next position with »◀« or »▶« and repeat.
- 4 Store the channel name with »?« (blue).

Note:

To enter additional channel names, repeat steps 1 to 4.

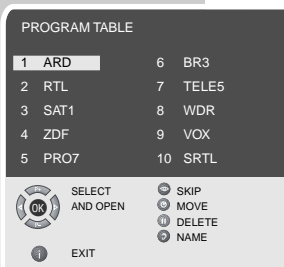

Skipping television channels

You can mark television channels which should be skipped during selection with »P+« or »P-«. A selection with the number keys is also possible.

- 1 In the »PROGRAM TABLE« menu, select the desired channel with »P+«, »P-«, »◀« or »▶«.
- 2 Highlight the channel with »👁« (red).
– The station is now displayed in red.
– You can deselect the selected channel by pressing the red button again.

Concluding the settings

- 1 Press »i« to finish the settings.

SETTINGS

Picture settings

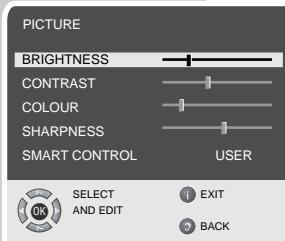

- 1 Press **»i«** to open the **»INFO«** menu.
– The **»INFO«** menu appears.
- 2 Select **»PICTURE«** with **»P+«** or **»P-«** and confirm with **»OK«**.
– The **»PICTURE«** menu appears.
- 3 Select **»BRIGHTNESS«**, **»CONTRAST«**, **»COLOUR«** or **»SHARPNESS«** with **»P+«** or **»P-«** and adjust them with **»◀«** or **»▶«**.

Notes:

After a short while the **»PICTURE«** menu reappears.
The settings are saved as the **»USER«** picture default setting.

- 4 Press **»i«** to finish the settings.

Audio settings

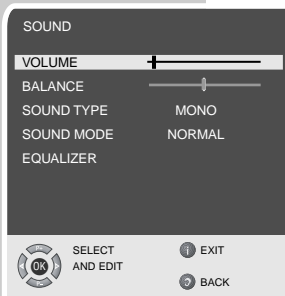

- 1 Press **»i«** to open the **»INFO«** menu.
– The **»INFO«** menu appears.
- 2 Select **»SOUND«** with **»P+«** or **»P-«** and confirm with **»OK«**.
– The **»SOUND«** menu appears.

Note:

Further operation is explained in the following sections.

Volume

The standard volume is set here. This is the volume of the device after switching on.

- 1 Select **»VOLUME«** with **»P+«** or **»P-«** and adjust the setting with **»◀«** or **»▶«**.

Balance

- 1 Select **»BALANCE«** with **»P+«** or **»P-«** and adjust the setting with **»◀«** or **»▶«**.

Stereo / two channel, mono

If the device receives two channel programmes, e.g. a film with the original sound on sound channel B (display: **»Dual II «**) and the dubbed version on sound channel A (display: **»DUAL I«**), you can select the sound channel you desire.

If the device receives stereo or Nicam programmes, it switches automatically to stereo sound (display: **»STEREO«**).

You can switch the sound to **»MONO«** if the stereo reception quality is poor.

- 1 Select **»SOUND«** with **»P+«** or **»P-«** and adjust the setting with **»◀«** or **»▶«**.

SETTINGS

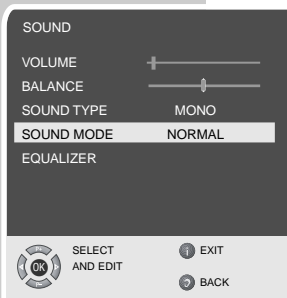

Stereo width

Widens the audio output for stereo programmes and improves the sound with mono reception.

- 1 Select »SOUND MODE« with »P+« or »P-«.
- 2 Press »◀« or »▶« to select the setting.

Equaliser

The equaliser offers you four pre-programmed sound settings (Music, Sport, Cinema and Dialogue) and two which you can modify yourself (User 1 and User 2).

- 1 Select »EQUALIZER« with »P+« or »P-« and confirm with »OK«.
– The »EQUALIZER« menu appears.
- 2 Select the audio setting »USER 1« or »USER 2« with »P+« or »P-« and confirm with »OK«.
– The frequency band »120 Hz« is activated.
- 3 Set the desired value with »P+« or »P-« and select the next frequency band with »◀« or »▶«.
- 4 Press »OK« to save the setting.

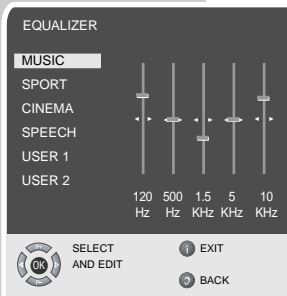

Concluding the settings

- 1 Press »i« to finish the settings.

TELEVISION OPERATION

Basic functions



Switching on and off

- 1 Switch on the television by pressing the »IO« button on the television set.
– The device switches to standby mode.
Switch the television on with »1...0« or »P+« or »P-«.
- 2 Press the »IO« button to switch the television to standby mode.
Press »1...0« or »P+« or »P-« to switch on the device from standby mode.
- 3 Completely switch the television off by pressing »IO« on the television set.
– This saves electricity.

Selecting channels

- 1 Use »1...0« to select channels directly.
- 2 Press »P+« or »P-« to move up and down channels.

Selecting AV channel positions

- 1 Use »AV« to select AV channels directly.

Adjusting the volume

- 1 Adjust the volume with »◀« or »▶«.

Muting

- 1 Use »🔇« to switch the sound off (mute) and to switch it on again.

Displaying time

- 1 You can display the time by pressing the »🕒« button (only for channels with teletext).

Picture settings

You can select four different picture settings.



- 1 Select the desired picture setting from »USER«, »NATURAL«, »RICH« or »SOFT« with »👁«.
– You can alter the »USER« picture setting, see the "Picture settings" chapter on page 12.

Audio settings

You can select six different audio settings.

- 1 Select the desired sound setting from »USER 1«, »USER 2«, »MUSIC«, »SPORT«, »CINEMA« or »SPEECH« with »🔊«.
– You can alter the »USER 1« and »USER 2« sound settings, see the "Equaliser" chapter on page 13.

Changing the picture format

- 1 Select the picture format with   .
– You can choose between the following picture formats:

»4:3« format

The picture is shown in 4:3 format.

»AUTO« format

The picture format is automatically switched to »16:9« for 16:9 programmes.

For programmes in 4:3 format, the picture automatically fills the screen.

»16:9« format

During programmes in 4:3 format the picture is stretched horizontally if the »16:9« format is selected.

The picture geometry is stretched horizontally.

With actual 16:9 signal sources (from a SET-TOP box on the Euro-AV socket) the picture fills the screen completely and with the correct geometry.

Zap function

This function allows you to save the television channel which you are currently watching and switch to other channels (zapping).

- 1 Select the channel you want to save in the zap memory with »1...0« or »P+« »P-«, (e.g. channel 1, BBC 1) and save by pressing »Z«.
– The display »z 1« appears in the screen.
- 2 Change channels with »1...0« or »P+« »P-«.
- 3 You can now use »Z« to switch between the saved channel (in the example, BBC1) and the channel you were watching before.
- 4 Press  to quit the zap function.
– The display disappears.

TELETEXT MODE







TOP text or FLOF text mode

- 1 Press »**TXT**« to switch to teletext mode.
- 2 You can directly select teletext pages with »**1...0**«.

Note:

At the bottom of the screen, you will see an information line consisting of a red, green and, depending on the station, yellow and blue text field. Your remote control has buttons with the corresponding colours.

- 3 Press »« (red) to scroll back a page.
- 4 Press »« (green) to scroll to the next page.
- 5 Press »« (yellow) to select chapters.
- 6 Press »« (blue) to select topics.
- 7 Press »**TXT**« to switch off teletext mode.

Normal text mode

- 1 Press »**TXT**« to switch to teletext mode.
- 2 You can directly select teletext pages with »**1...0**«.
- 3 Press »**P-**« to scroll back a page.
- 4 Press »**P+**« to scroll to the next page.
- 5 Press »**TXT**« to switch off teletext mode.

Additional functions

Skipping the waiting time

While a page is being searched for, you can switch to the television channel.

- 1 Enter the teletext page number using »**1...0**« and then press »**POS**«.
– »« appears instead of the page number. As soon as the page is found, the page number is displayed.
- 2 Press »**POS**« to switch to the teletext page.

Increasing character size

If you have difficulty reading the text on the screen, you can double the character size.

- 1 To enlarge the character size of a teletext page, press »**-/-**« repeatedly.

TELETEXT MODE



Page stop

A multiple page may contain several sub-pages, which are automatically scrolled by the transmitting station.

- 1 Stop the sub-pages with »**PAP**«. – »« is displayed instead of the page number.
- 2 Press »**PAP**« to quit the function.

Calling up a sub-page directly

If the selected teletext page contains further pages, the number of the current sub-page as well as the total number of pages is displayed.

- 1 Call up the sub-pages with »**SIZE**«.
- 2 Enter the four-digit number of the sub-page with »**1...0**«. – The selected sub-page is appears after a short delay.

Reveal answer

Certain teletext pages contain "hidden answers" or information which can be called up.

- 1 Display information with »**SCAN**«.
- 2 Conceal information with »**SCAN**«.

CONVENIENCE FUNCTIONS

Convenience functions with the »FEATURES« menu

- 1 Press »i« to open the »INFO« menu.
- 2 Select »FEATURES« with »P+« or »P-« and confirm with »OK«.

Note:

Further operation is explained in the following sections.

Changing the menu language

- 1 Select »LANGUAGE« with »P+« or »P-« and confirm with »OK«.
– The »LANGUAGE« menu appears.
- 2 Select the language with »P+«, »P-«, »◀« or »▶« and press »OK« to confirm.
- 3 Press »i« to finish the setting.

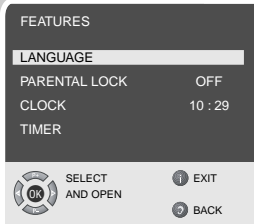

Parental lock

- 1 Select »PARENTAL LOCK« with »P+« or »P-«.
- 2 Press »◀« or »▶« to activate the parental lock (ON) or deactivate it (OFF).
- 3 Press »i« to finish the setting.

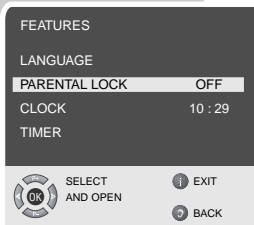

Entering the time

- 1 Select »CLOCK« with »P+« or »P-«.
- 2 Enter the time in four digits with »1...0«.
- 3 Press »i« to finish the setting.

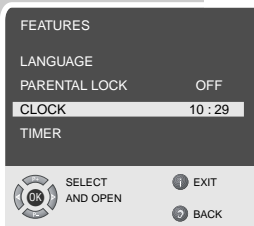

Entering the switch-on and off times

You can set times for the television to switch on and off in the »TIMER« menu. After this time has elapsed, the television switches to standby mode or switches on from standby mode. Under »PROG. NUMBER« you can enter the TV station with which the television switches on.

- 1 Select »TIMER« with »P+« or »P-« and press »OK« to confirm.
- 2 Select »PROGRAM NO«, »ON TIME« or »OFF TIME« with »P+« or »P-«.
- 3 Enter the station, switch-on time or switch-off time with »1...0«.
- 4 Press »i« to finish the setting.

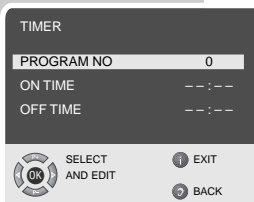

USING EXTERNAL DEVICES

Note:

Do not connect any other equipment while the device is switched on. Switch off the other equipment as well before connecting it. Only plug the device into the mains socket after you have connected the external devices and the antenna.

Video recorder, DVD player or SET-TOP box

Connecting the video recorder, DVD player or SET-TOP box

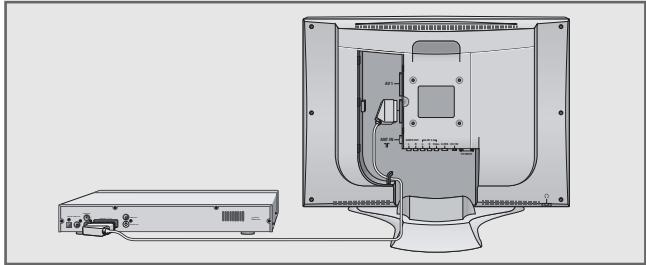

- 1 Connect the »AV1« or »AV2« socket (Amira 17 and 20 only) on the television and the corresponding socket on the video recorder, DVD player or the set-top box with a Euro-AV (Scart) cable.

Using a video recorder, DVD player or SET-TOP box

- 1 Switch on the video recorder, DVD player or SET-TOP box and select the function you wish to use.
- 2 Select »AV1« or »AV2« (Amira 17 and 20 only) by pressing »AV«.
 - You can hear and see the video and audio information from the video recorder or the SET-TOP box on the television set.

Connecting the SVHS video recorder

If you own a SVHS video recorder, you can connect it using a SVHS cable to the »S-VHS« socket.

Using a SVHS video recorder

- 1 Switch on the video recorder and select the function you wish to use.
- 2 Select the »AVS« preset channel with »AV«.
 - You will see the picture and hear the sound of the video recorder on the television.

USING EXTERNAL DEVICES

Decoder or satellite receiver

In order for the television to receive encoded programs from a privately operated station, a decoder is needed.

Connecting a decoder or satellite receiver

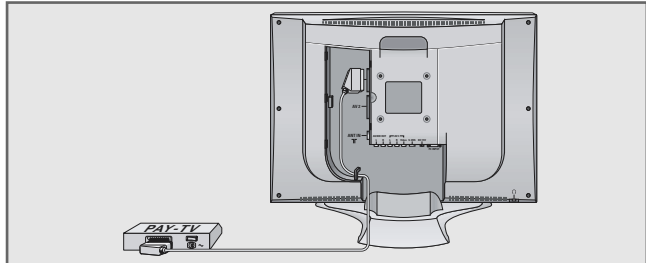

- 1 Connect the »AV1« socket on the television set and the appropriate socket on the decoder using a EURO-AV cable.

Notes:

A satellite receiver can also be connected to this socket.

If you want to use both a satellite receiver and a decoder, the decoder must be connected to the satellite receiver.

Using a decoder

- 1 Switch on the television and the decoder.
- 2 Select the »AV1« preset channel by pressing »AV« repeatedly until »AV1« appears on the screen.

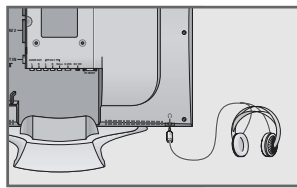

Headphones



Connecting headphones

- 1 Insert the headphone jack (3.5 mm ø jack plug) in the headphone socket on the bottom.

Adjusting the headphone volume

- 1 Press »« to mute the television sound.
- 2 Press »« or »« to adjust the headphone volume.

USING EXTERNAL DEVICES

Camcorder

Connecting the camcorder

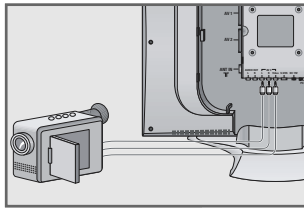

- 1 Connect the yellow socket »AV3 Video« on the television and the corresponding socket on the camcorder (VHS, Video 8) with a cinch cable (picture signal)

or

connect the »S-VHS« socket (picture signal) on the television and the corresponding socket on the camcorder (S-VHS, Hi 8) with a cinch cable.

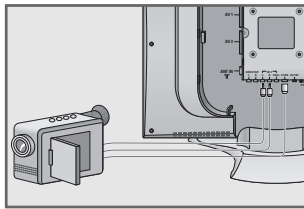

- 2 Connect the white and red sockets »AV3 LR« on the television and the corresponding sockets on the camcorder with a cinch cable (audio signal).

Note:

If a mono camera is connected, connect the white socket »AV3 L« on the television and the corresponding socket on the camera. Select »MONO« in the »SOUND« menu for mono operation.

Operating with a camcorder (VHS, Video 8)

- 1 Switch on the camcorder, insert a cassette and start playback.
- 2 Select the »AV3« (for VHS, Video 8) or »AVS« (for S-VHS, Hi 8), by pressing »AV« repeatedly until »AV3« or »AVS« is displayed on the television.
 - You will see the picture and hear the sound of the camcorder on the television.

HiFi system

Connecting the HiFi system

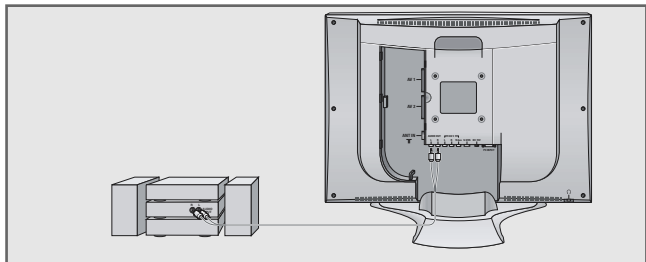

- 1 Connect the white and red sockets »AUDIO OUT L R « on the television and the corresponding sockets on the HiFi with a cinch cable.

PC MONITOR MODE

Note:

The Amira 20 is not suitable for use with a PC.

Connecting a PC

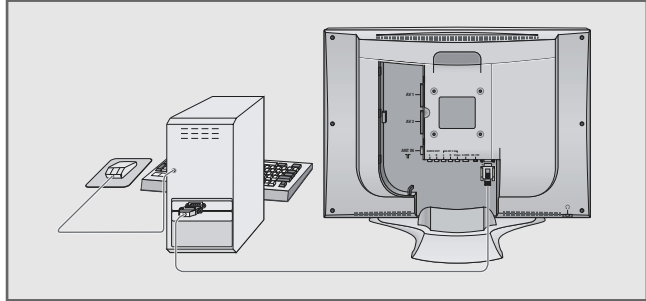

- 1 Connect the »VGA« socket on the television set and the appropriate socket of the PC using a VGA cable.

Selecting the channel position for the PC

- 1 Select the PC channel position with »-/--«.

PC settings

These settings are only possible when signals are received from a PC.

- 1 Press »i« to open the »INFO« menu.
– The »INFO« menu appears.
- 2 Select »SEARCH/TUNE« with »P+« or »P-« and press »OK« to confirm.
– The PC menu appears.
- 3 Select the function or setting you want with »P+« or »P-« and press »◀« or »▶« to execute it.
– Options:
»CLOCK« Set the cycle frequency
»PHASE« Remove horizontal flicker, blurring and horizontal lines
»H. POSITION« Adjust the picture position horizontally
»V. POSITION« Adjust the picture position vertically
»AUTO CONFIG« For automatic PC configuration
- 4 Press »i« to exit the PC menu.

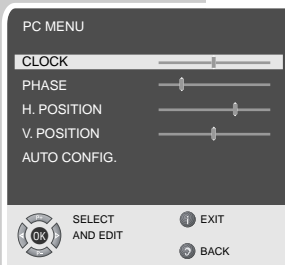

SPECIAL SETTINGS

Setting television channels

This setting is only necessary if a new channel comes on air and you do not want to change the order of your channels. The television channel can be set directly or using the search.

Setting channels using the search

- 1 Press »i« to open the »INFO« menu.
– The »INFO« menu appears.
- 2 Select »SETUP« with »P+« or »P-« and confirm with »OK«.
– The »SETUP« menu appears.
- 3 Select »MANUAL SETTING« with »P+« or »P-« and confirm with »OK«.
- 4 Select »PROGRAM NO« with »P+« or »P-« and set the preset channel with »◀« or »▶«.
- 5 Select »SEARCH« with »P+« or »P-« and start the search with »◀« or »▶«.
– If a strong station signal is received, the search is interrupted and the picture appears. Repeat the search until the channel you want appears on the screen.

Note:

The current system is automatically displayed in the »SYSTEM« line.

- 6 Select »STORE« with »P+« or »P-« and confirm with »OK«.
– The »STORED« message appears.

Note:

To set other television stations, repeat steps 3 to 6.

- 7 Press »i« to finish the setting.

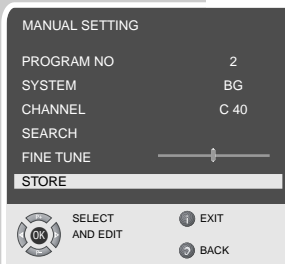
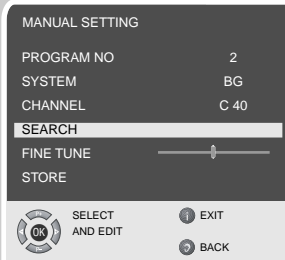
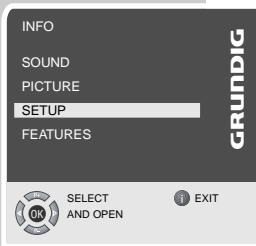

SPECIAL SETTINGS

Fine tuning television channels

The television automatically tunes itself to the best possible reception. You may need to carry out manual fine tuning in areas where there is poor reception.

- 1 Press »i« to open the »INFO« menu.
– The »INFO« menu appears.
- 2 Select »SETUP« with »P+« or »P-« and confirm with »OK«.
– The »SETUP« menu appears.
- 3 Select »MANUAL SETTING« with »P+« or »P-« and confirm with »OK«.
- 4 Select »FINE TUNE« with »P+« or »P-« and set it with »◀« or »▶«.
- 5 Select »STORE« with »P+« or »P-« and confirm with »OK«.
– The »STORED« message appears.
- 6 Press »i« to finish the setting.

Setting the television channels by entering the channel numbers

- 1 Press »i« to open the »INFO« menu.
– The »INFO« menu appears.
- 2 Select »SETUP« with »P+« or »P-« and confirm with »OK«.
– The »SETUP« menu appears.
- 3 Select »MANUAL SETTING« with »P+« or »P-« and confirm with »OK«.
- 4 Select »PROGRAM NO« with »P+« or »P-« and set the preset channel with »◀« or »▶«.
- 5 Select »CHANNEL« with »P+« or »P-«.
- 6 Press »OK« to choose between »S« (special channel) and »C« (channel).
- 7 Press »◀« or »▶« to switch up and down channels or use »1...0« to enter the channel number directly.

Note:

The current system is displayed in the »SYSTEM« line.

- 8 Select »STORE« with »P+« or »P-« and confirm with »OK«.
– The »STORED« message appears.
- Note:**
To set the other television stations, repeat steps 3 to 8.
- 9 Press »i« to finish the setting.

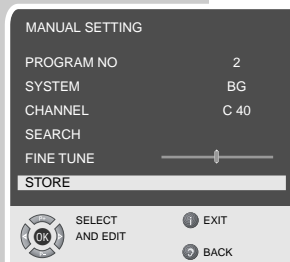
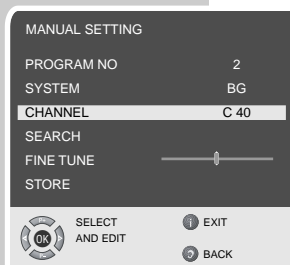
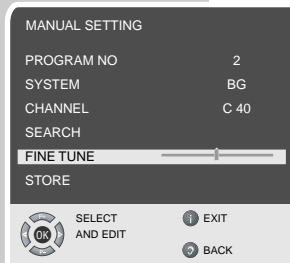

SPECIAL SETTINGS

Re-tuning all television channels

You can re-tune all the television stations, for example if you move to another town.

- 1 Press **»i«** to open the **»INFO«** menu.
– The **»INFO«** menu appears.
- 2 Select **»SETUP«** with **»P+«** or **»P-«** and confirm with **»OK«**.
– The **»SETUP«** menu appears.
- 3 Select **»STATION SEARCH«** with **»P+«** or **»P-«** and confirm with **»OK«**.
– The **»COUNTRY SELECTION«** menu appears.
- 4 Press **»P+«**, **»P-«**, **»◀«** or **»▶«** to select the country and **»OK«** to confirm.
– A warning message appears.
- 5 Press **»OK«** to start the search.
– The search begins. It may last a few minutes, depending on the number of television stations found.
– The automatic search may last a few minutes, depending on the number of television channels received.

Note:

You can interrupt the search by pressing **»i«**.

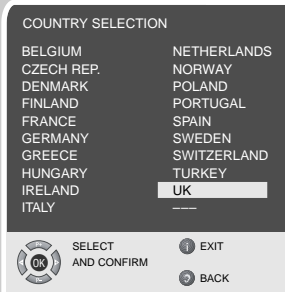
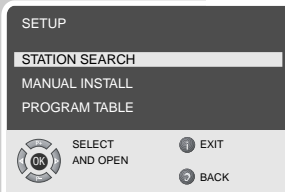

INFORMATION

Technical data

Operating voltage:	DC 12 V, 4 A with 100 – 240 V mains adapter, 50/60 Hz (Amira 15) DC 12 V, 5 A with 100 – 240 V mains adapter, 50/60 Hz (Amira 17) DC 15 V, 4,5 A with 100 – 240 V mains adapter, 50/60 Hz (Amira 20)
Power consumption:	in operation 36 W (Amira 15) in operation 54 W (Amira 17) in operation 60 W (Amira 20) in standby approx. 3,5 W
Sound output:	2 x 3 music power (2 x 2 sine wave) (Amira 15) 2 x 5 music power (2 x 3 sine wave) (Amira 17, Amira 20)
Reception range:	C01 ... C80, special channels S01 ... S41
Preset channels:	99 and 5 AV (Amira 17, Amira 20) 99 and 4 AV (Amira 15)
Screen size:	38 cm/15" (Amira 15) 43 cm/17" (Amira 17) 51 cm/20" (Amira 20)
Max. resolution:	XGA 1024 x 768 (Amira 15) WXGA 1280 x 768 (Amira 17) VGA 640 x 480 (Amira 20)

Service information for dealers

The television set may only be operated with the mains adapter supplied.

The product complies with the following EU directives:
73/23/EEC directive for electrical equipment to be used within defined voltage ranges. 89/336/EEC directive on electromagnetic compatibility.

The device complies with the following standards: EN 60065, EN 55013, EN 55020

Environmental note

This product has been made from high-quality parts and materials which can be re-used and recycled.

Therefore, do not throw the product away with normal household waste at the end of its life. Take it to a collection point for recycling electrical and electronic devices. This is indicated by this symbol on the product, in the operating manual and on the packaging. Please find out about collection points operated by your local authority.

Help protect the environment by recycling used products.

Subject to alteration and correction!

Download from [Www.Somanuals.com](http://www.Somanuals.com). All Manuals Search And Download.

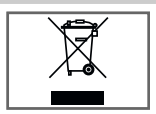

INFORMATION

Troubleshooting

If the remedies given below do not work, please consult an authorised GRUNDIG dealer. Please bear in mind that malfunctions can also be caused by external devices such as video recorders or satellite receivers.

Fault	Possible cause	Remedy
Screen lit (snow), but no station	Antenna cable	Is the antenna cable connected?
	No television station programmed	Start the station search
Poor picture contrast	Picture settings incorrectly set	Adjust the brightness, contrast or colour setting
	Problem at station	Test with another channel
Interference to picture and/or sound	Interference from other devices	Change the position of the device
Ghosts, reflection	Channel setting	Automatic or manual channel setting/fine tuning
	Antenna	Have antenna cable or system checked
No colour	Colour intensity at minimum	Turn up the colour
	TV standard setting (if setting option is available)	Select the correct colour standard
	Problem at station	Test with another channel
Picture but no sound	Volume set to minimum	Turn up or switch on the volume
	Problem at station	Test with another channel
Teletext missing or faulty	Television station (has no teletext) or antenna system	Test another channel for fine tuning and ghosts
	Station signal too weak	Check the antenna system
Remote control does not work	No optical connection	Point the remote control at the television set
	Remote control batteries	Check the batteries, change if necessary
	Operating condition undefined	Switch off the television with the main power button for approximately 2 minutes
The picture is dark after switching on	Parental lock has been activated	Switch off the parental lock

INFORMATION

Additional Information for units sold in the UK.

Units sold in the UK are suitable for operation from a 240V ac, 50Hz mains supply.

The range of multi-system receivers is built to work in most European countries. However, the mains plug and socket system for the UK differs from many European countries.

This appliance has been supplied with a fitted, non-removable, approved converter plug for use in the UK. This converter plug is fitted with a 5A rated fuse.

In case this appliance is supplied with a moulded 2-pin Euro plug only, which is unsuitable for UK operation, this must be cut off and immediately disposed of. An approved 13A, 3-pin UK plug should then be fitted by a qualified electrician.

Note:

The severed Euro plug must be destroyed to avoid a possible shock hazard should it be inserted into a socket elsewhere.

If a non-rewireable 3-pin plug or a rewireable 13A (BS1363) 3-pin plug is used, it must be fitted with a 5A ASTA or BSI approved BS1362 fuse. If any other type of plug is used it must be protected by a 5A fuse either in the plug, or at the distribution board. If this type of plug becomes defective, ensure that the fuse is removed before disposal, to eliminate potential shock hazard.

If it is necessary to change the fuse in the non-rewireable plug, the correct type and rating (5A ASTA or BSI approved BS1362) must be used and the fuse cover must be refitted. If the fuse cover is lost or damaged, the lead and plug must not be used until a replacement is obtained. Replacement fuse covers should be obtained from your dealer.

Important:

The wires in the mains lead are colour coded in accordance with the following code:

BLUE – NEUTRAL

BROWN – LIVE

As the colours of the wires in the mains lead of your appliance may not correspond with the coloured marking identifying terminals in your plug, proceed as follows:

Connect the BLUE coloured wire to plug terminal marked with the letter "N" or coloured black.

Connect the BROWN coloured wire to the plug terminal marked with the letter "L" or coloured red.

In no circumstance must any of the wires be connected to the terminal marked with the letter "E", earth symbol "⏏", coloured green, or green & yellow.

Free Manuals Download Website

<http://myh66.com>

<http://usermanuals.us>

<http://www.somanuals.com>

<http://www.4manuals.cc>

<http://www.manual-lib.com>

<http://www.404manual.com>

<http://www.luxmanual.com>

<http://aubethermostatmanual.com>

Golf course search by state

<http://golfingnear.com>

Email search by domain

<http://emailbydomain.com>

Auto manuals search

<http://auto.somanuals.com>

TV manuals search

<http://tv.somanuals.com>