

**COLOR
TELEVISION**

GERMIG

**ELEGANCE 15 FLAT
TVD 40-2501 TEXT**

**DEUTSCH
ENGLISH
NEDERLANDS
ESPAÑOL
PORTUGUÊS**

CONTENTS

3

Set-up and safety

4

Connection and preparation

4

Connecting the antenna and the power cable

4

Inserting batteries in the remote control

5-8

Overview

5-7

The remote control

8

The front of the television

9-11

Settings

9

Tuning television channels automatically

9-10

Changing stored channels

11

Picture settings

12-13

Television operation

14-15

Teletext mode

14

FLOF text and normal text mode

14-15

Additional functions

16-17

Convenience functions

16-17

Convenience functions with the »FEATURES« menu

18-26

DVD mode

18

Special DVD features

18

Disc formats

19-21

Preparation

22-23

Using a DVD, video CD or audio CD

24

Additional functions during DVD or video CD playback

25

Using an MP3 CD or JPEG CD

25

Additional JPEG CD playback functions

26

Creating and playing a playlist

27-28

DVD settings

27

Selecting the setup menu

27-28

Menu options

29-32

Using external devices

29

Decoder or satellite receiver

29

Headphones

30

Video recorder or set top box

31

Camcorder

32

Connecting a multi-channel amplifier or digital two channel audio system

33-34

Special settings

33-34

Setting television channels

35-38

Information

35-38

Technical data, service information for dealers,

General instructions for laser devices, troubleshooting,

Additional Information for units sold in the UK

SET-UP AND SAFETY

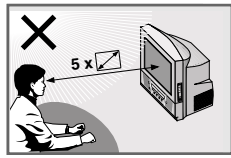

Please note the following information when setting up your television set.

This television set is designed to receive and display video and audio signals. Any other use is expressly prohibited.

The ideal viewing distance is 5 times the screen diagonal. External light falling on the screen impairs picture quality.

Ensure sufficient clearance between the TV and the wall cabinet.

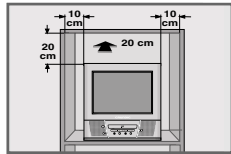

The television set is designed for use in dry rooms. If you do use it in the open, please ensure that it is protected from moisture, such as rain or splashing water. Do not expose the television set to any moisture.

If the television is subject to sudden changes in temperature, for example if it is brought in from the cold to a warm room, connect it to the mains supply and let it stand for at least two hours before you insert a disc.

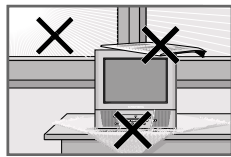

Do not place any vessels such as vases on the television, as they may spill liquid, thus presenting a safety risk.

Place the television set on a solid, level surface. Do not place any objects such as newspapers on the television set or cloth or similar items beneath it.

Do not place the television set close to heating units or in direct sunlight, as this will impair cooling.

Heat build-up can be dangerous and shortens the operating life of the television set. For reasons of safety, have a specialist remove any dirt deposits in the set from time to time.

Keep the television set away from magnetic fields (loudspeaker boxes, for example).

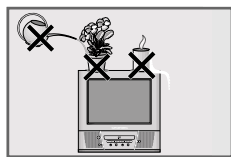

Do not open the television set under any circumstances. No warranty claims are accepted for damage resulting from improper handling.

Ensure that the mains cable is not damaged.

Thunderstorms are a danger to all electrical devices. Even if the television set is switched off, it can be damaged by a lightning strike to the mains or the antenna cable. Always disconnect the mains and antenna plugs during a storm.

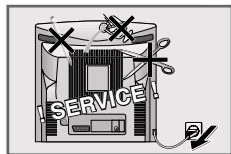

Do not insert foreign objects in the disc compartment.

If the device is unable to scan discs perfectly, use a standard, commercially available cleaning CD to clean the laser optics. Other cleaning methods may damage the laser optics.

Always keep the disc compartment closed to prevent dust from collecting on the laser optics.

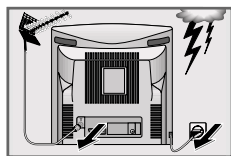

Clean the screen with a soft, damp cloth. Only use plain water.

CONNECTION AND PREPARATION

Connecting the antenna and the mains cable

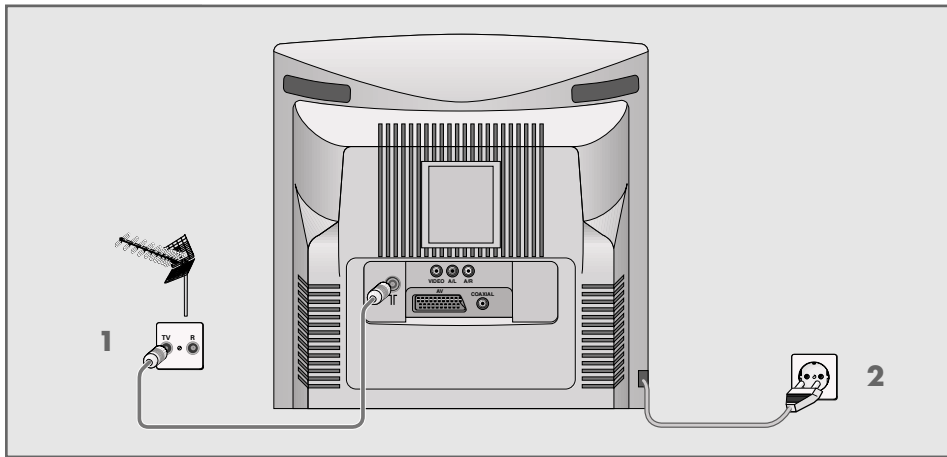

- 1 Plug the antenna cable of the rooftop antenna into the »|« antenna socket on the television.
- 2 Plug the mains cable into the wall socket.

Inserting batteries in the remote control

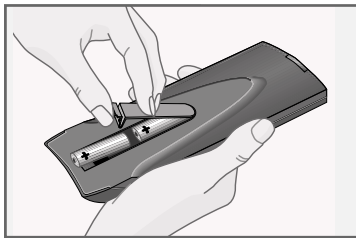

- 1 Open the battery compartment by removing the lid.
- 2 Insert batteries (micro type, e.g. LR 03 or AAA, 2 x 1.5 V). Observe the polarity (marked on the base of the battery compartment).
- 3 Close the battery compartment.

Note:

If the television no longer reacts properly to remote control commands, the batteries may be flat. Be sure to remove used batteries.

The manufacturer accepts no liability for damage resulting from leaking batteries.

Environmental note

Batteries, including those which contain no heavy metal, may not be disposed of with household waste. Please dispose of used batteries in an environmentally sound manner. Find out about the legal regulations which apply in your area.

OVERVIEW

The remote control

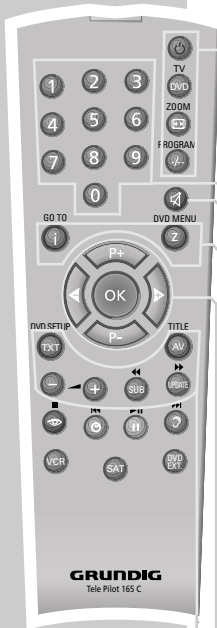

TV operation



Switches off the television set (stand-by).

TV/DVD

Switches the remote control from TV mode to DVD mode and back.



Switches between picture formats.
Reveal answer in teletext mode.



Switches between single- and double-digit preset channels.
Switches to double character size in teletext mode.

1...0

Switch the television on from standby mode.
Select channels directly.



Sound on/off (mute).



Opens and closes the info menu;
closes all menus.



Zap function.
Page hold in teletext mode.

P+, P-

Switch the television on from standby.
Select channels step-by-step.
Move the cursor up and down.



Calls up the station list.
Activates various functions.



Move cursor to the left/right.

TXT

Switches between teletext and TV modes.
Hides the menu.

AV

Selects the AV channels and the most recently viewed television channel.



Adjust the volume.

SUB

Selects sub-pages in teletext mode.

UPDATE

Updates the page in teletext mode.

OVERVIEW

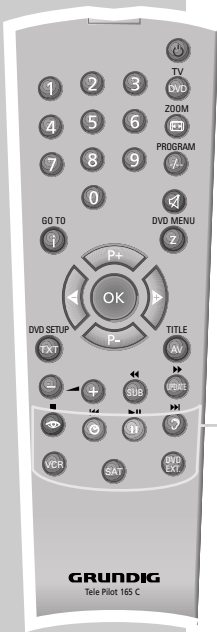

Selects a page in teletext mode.



Shows the time.

Selects a page in teletext mode.



Selects a page in teletext mode.



Selects a page in teletext mode.

**VCR, SAT
DVD EXT.** Switches to operating a GRUNDIG videorecorder,
a GRUNDIG satellite receiver or a GRUNDIG
DVD player.

Keep the appropriate button (**»VCR«**, **»SAT«**, **»DVD
EXT.«**) pressed down. Then press the appropriate
button.

Note:

The functions available depend on the model of the
device you are using.
Just try it out.

OVERVIEW

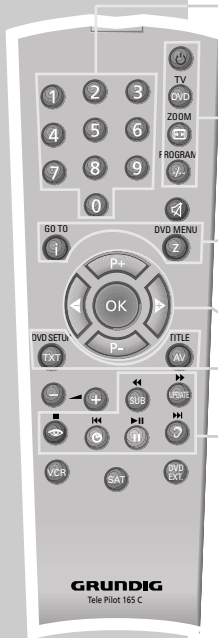

DVD mode

1...0

Numerical keys for various inputs.

TV/DVD

Switches the remote control from TV mode to DVD mode and back.

ZOOM

Zooms in/out on scenes during playback.

PROGRAM

For programming a playback list for the inserted disc.

GO TO

Opens the info menu of DVD unit.

DVD MENU

During playback, opens the disc menu* on a DVD.

P+, P-
◀ ▶

Select various functions in the menus.

OK

Confirms functions.

DVD SETUP

Opens the main menu on the DVD unit.

TITLE

Calls up the DVD title menu* during playback.

◀◀

Switches to reverse frame search at various speeds during playback.

▶▶

Switches to forward frame search at various speeds during playback.

■

Interrupts all drive functions.

◀◀

Selects the previous title or section during playback.

▶▶

Starts playback.
Freeze-frame for DVDs and video CDs.
Pause for audio CDs and MP3 CDs.

▶▶

Selects the next title or section during playback.

* Depends on the DVD in use

OVERVIEW

The front of the television set

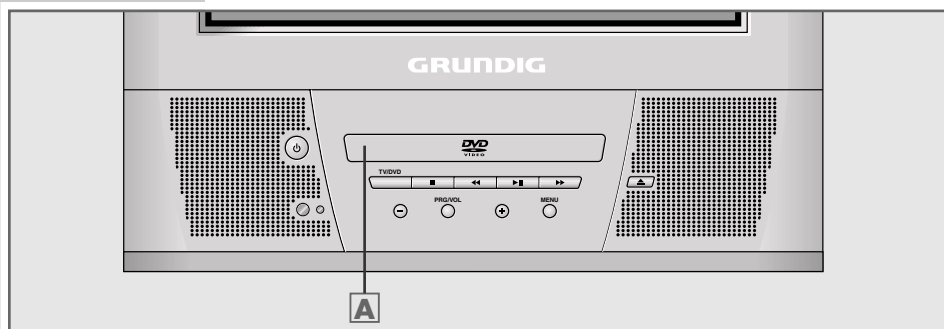

- ⓘ Switches the television into and out of standby mode.
- A** Compartment for CD media.
- TV/DVD** Switches the device from TV mode to DVD mode and back.
- Interrupts all drive functions.
- ⏪ Selects the previous title or section during playback.
Selects various functions in the menus.
- ▶ / ⏸ Starts playback.
Freeze-frame for DVDs and video CDs.
Pause for audio CDs and MP3 CDs;
activates menu functions.
- ⏩ Selects the next title or section during playback.
Selects various functions in the menus.
- ▲ Opens and closes the disc compartment.
- PROG/VOL** Preset button for volume or channel selection.
- Channel selection down.
Reduce volume.
- + Switches the television on from stand-by.
Channel selection up.
Increase volume.
- MENU** Opens the TV menu, switches to the previous page in the TV menu.
Opens the main menu of the DVD unit.
- 🎧 Headphone jack (3.5 mm ø jack plug).
- VIDEO** Video signal input for camcorder.
- R AUDIO L** Audio signal input for camcorder.

SETTINGS

Setting television channels automatically

The television set is equipped with an automatic channel search system.

You start the search and can then sort the television channels into your order of preference.

100 preset positions are provided, to which you can assign television channels from the antenna or from the cable connection.

You can also delete television channels from the channel list which were found more than once or which have poor reception.

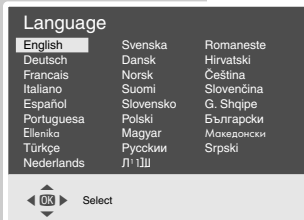

- 1 Switch on the television with »**I**« on the television set, then press »**P+**« on the remote control.
 - The »Language« menu appears when the television is first switched on.

Hint:

If the »Language« menu does not appear on the screen, then set it in accordance with the chapter on resetting all television channels on page 34.

- 2 Select language with »**P+**«, »**P-**«, »**◀**« or »**▶**« and press »**OK**« to confirm.
 - The »Country Selection« menu appears.



- 3 Press »**P+**«, »**P-**«, »**◀**« or »**▶**« to select the country and »**OK**« to confirm.

Note:

If your country is not displayed, select ».....«.

- 4 Press »**OK**« to start the search.
 - The »Setup« menu appears and the search begins. The automatic search may last several minutes depending on the number of television channels received.
 - After the search, the television switches to channel 1.

Changing stored channels

You can delete channels that have been stored more than once during the automatic search. You can also store channels in a different preset position, change or enter the name of a channel as well as skip channels.

Selecting the station list

- 1 Press »**i**« to open the »Main Menu«.
 - The »Main Menu« appears.
- 2 Select »Program Table« with »**P+**« or »**P-**« and confirm with »**OK**«
 - The »Program Table« menu appears.

Note:

Further operation is explained in the following sections.

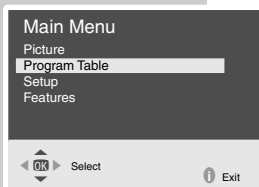

SETTINGS

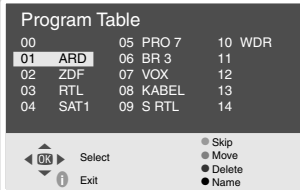

Deleting channels

- 1 In the »Program Table« menu, select the station to be deleted by pressing »P+«, »P-«, »◀« or »▶«.
- 2 Press »⏏« (yellow) to delete the channel.

Note:

To delete other stations, repeat steps 1 and 2.

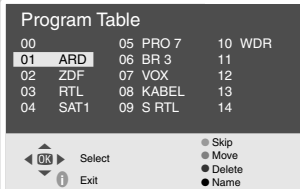

Sorting television channels

- 1 In the »Program Table« menu, select the channel to be moved with »P+«, »P-«, »◀« or »▶«.
- 2 Highlight the channel with »⏪« (green).
- 3 Select a new channel position by pressing »P+«, »P-«, »◀« or »▶« and then press »⏩« to confirm.
– All of the channels that follow move up one position.

Note:

To sort the other television channels repeat steps 1 to 3.

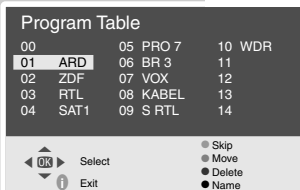

Entering the channel names (maximum of 5 characters)

- 1 In the »Program Table« menu, select the desired channel with »P+«, »P-«, »◀« or »▶«.
- 2 Highlight the channel with »⏪« (blue).
- 3 Select letters or numbers with »P+« or »P-«, move to the next position with »◀« or »▶« and repeat.
- 4 Store the channel name with »⏩« (blue).

Note:

To enter additional channel names, repeat steps 1 to 4.

Skipping television channels

You can mark television channels which should be skipped during selection with »P+« or »P-«. A selection with the number keys is also possible.

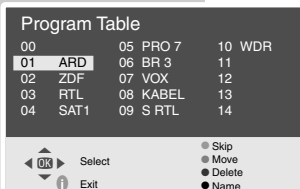

- 1 In the »Program Table« menu, select the desired channel with »P+«, »P-«, »◀« or »▶«.
- 2 Highlight the channel with »⏪« (red).
– The television channel is now displayed against a red background.
– You can deselect the selected channel by pressing the red button again.

Concluding the settings

- 1 Press »i« to finish the settings.

SETTINGS

Picture settings

- 1 Press »i« to open the »Main Menu«.
– The »Main Menu« appears.
- 2 Select »Picture« with »P+« or »P-« and confirm with »OK«.
– The »Picture« menu appears.
- 3 Select »Brightness«, »Contrast«, »Colour« or »Sharpness« with »P+« or »P-« and adjust them with »◀« or »▶«.
- 4 Press »i« to finish the settings.



TELEVISION OPERATION

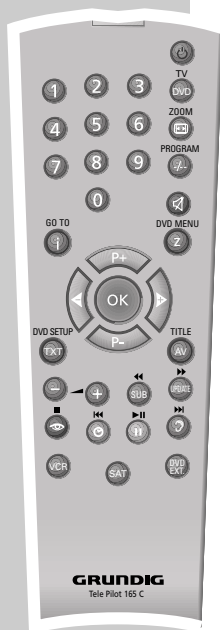

Switching on and off

- 1 Switch on the television by pressing the **»⏻«** button on the television set.
- 2 Press the **»⏻«** button to switch the television to standby mode. Press **»1...0«** or **»P+«** or **»P-«** to switch the television back on from standby.
- 3 Press **»⏻«** on the television set to switch it off completely.
– This saves electricity.

Selecting channels

- 1 Select channel positions directly with **»1...0«**.
Use **»-/--«** to select two digit channel positions.
- 2 Press **»P+«** or **»P-«** to move up and down channels.

Selecting AV channels

- 1 Use **»AV«** to select AV channels directly.

Adjusting the volume

- 1 Adjust the volume with **»- ▾«** or **» ▴ +«**.

Muting

- 1 Use **»🔇«** to switch the sound off (mute) and to switch it on again.

Displaying time

- 1 You can display the time by pressing the **»🕒«** button (only for channels with teletext).

Changing the picture format

The television automatically switches to the 16:9 format, if this format is recognised via the Euro-AV socket.

- 1 Select the picture format with **»📺«**. The selected picture format, for example **»16:9«**, appears on the screen.
– You can choose between the following picture formats:

»Auto« format

The picture format is automatically switched to **»16:9«** for 16:9 programmes.

The picture format is automatically switched to **»4:3«** for 4:3 programmes.

»4:3« format

For 4:3 programmes, select picture format **»4:3«**.

»16:9« format

For 16:9 programmes, select picture format **»16:9«**.

Zap function

This function allows you to save the television channel which you are currently watching and switch to other channels (zapping).

- 1** Select the channel you want to save in the zap memory with »**1...0**« or »**P+**« »**P-**«, (e.g. channel 1, BBC 1) and save by pressing »**Z**«.
– The display »z -> P1 BBC1« appears in the screen.
- 2** Change channels with »**1...0**« or »**P+**« »**P-**«.
- 3** You can now use »**Z**« to switch between the saved channel (in the example, BBC1) and the channel you were watching before.
- 4** Press »**i**« to quit the zap function.
– The display disappears.

TELETEXT MODE

FLOF text and normal text mode

Switching on teletext and selecting pages

- 1 Press »TXT« to switch on teletext.
- 2 Use »1...0« to enter the page number directly or »P+« and »P-« to switch up and down pages (to return to page 100, press »i«).

Note:

At the bottom of the screen, you will see an information line consisting of a red, green, yellow and blue text field. Your remote control has buttons with the corresponding colours.

- 3 Press »👁« (red), »🟢« (green), »🟡« (yellow) or »🟠« (blue) to select a teletext page. This depends on the options in the information line.
- 4 Press »TXT« to switch off teletext.

Additional functions

Skipping the waiting time

While a page is being searched for, you can switch to the television channel.

- 1 Enter the teletext page number with »1...0« and then press »UPDATE«.
– As soon as the page is found, the teletext page number appears in the top left hand corner of the screen.
- 2 Switch to the teletext page by pressing »UPDATE«.

Increasing the character height

If you have difficulty reading the text on the screen, you can double the character height.

- 1 To enlarge the character height of a teletext page, keep pressing »-/-«.

Page hold

A multiple page may contain several sub-pages, which are automatically scrolled by the transmitting station.

- 1 Hold the sub-pages with »Z«.
- 2 Press »Z« to end the function.



TELETEXT MODE

Opening a sub-page directly

If the selected teletext page contains additional pages, the number of the current sub-page and the total number of pages are displayed.

- 1 Press »SUB« to select the sub-page function.
- 2 Enter the four-digit sub-page number with »1...0«.
– The selected sub-page is displayed after a short delay.

Reveal answer

Certain teletext pages contain hidden answers or information. These can be viewed.

- 1 Press »[REVEAL]« to display the information.
- 2 Press »[HIDE]« to conceal the information.

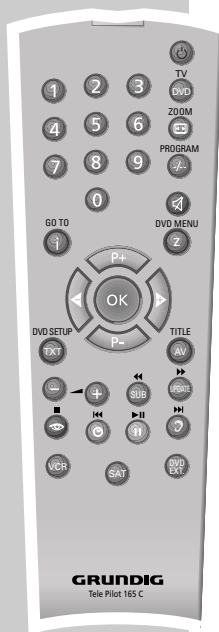

CONVENIENCE FUNCTIONS

Picture format

You can switch the picture format to 16:9 for widescreen broadcasts or DVDs.

- 1 Press »i« to open the »Main Menu«.
– The »Main Menu« appears.
- 2 Select »Features« with »P+« or »P-« and confirm with »OK«.
- 3 Select »Picture Format« by pressing »P+« or »P-«.
- 4 Select the picture format by pressing »◀« or »▶«.
- 5 Press »i« to finish the setting.

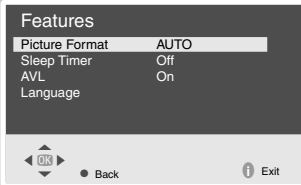

Entering the switch-off time

You can enter a switch-off time. After this time has elapsed, the television switches to standby mode.

- 1 Press »i« to open the »Main Menu«.
– The »Main Menu« appears.
- 2 Select »Features« with »P+« or »P-« and confirm with »OK«.
- 3 Select »Sleep Timer« with »P+« or »P-«.
- 4 Enter the required time (in 15 minute intervals from 15 to 120 minutes) by pressing »◀« or »▶«.
- 5 Press »i« to finish the setting.

Note:

To delete the switch-off time, select »Sleep Timer« again and press »◀« or »▶« to select »Off«.

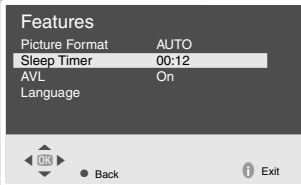

Automatic volume

Television stations broadcast at different volumes. The automatic volume limiting (AVL) function means the volume is kept the same when you switch between channels.

- 1 Press »i« to open the »Main Menu«.
– The »Main Menu« appears.
- 2 Select »Features« with »P+« or »P-« and confirm with »OK«.
- 3 Select »AVL« with »P+« or »P-« and then select »On« with »◀« or »▶«.
- 4 Press »i« to finish the setting.

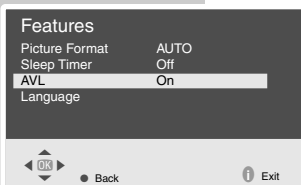

CONVENIENCE FUNCTIONS

Changing the menu language

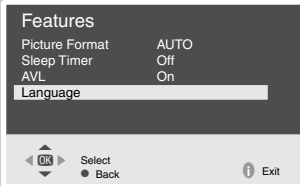

- 1 Press »i« to open the info menu.
– The info menu appears.
- 2 Select »Features« with »P+« or »P-« and confirm with »OK«.
- 3 Select »Language« with »P+« or »P-« and confirm with »OK«.
– The »Language« menu appears.
- 4 Select the language with »P+«, »P-«, »◀« or »▶« and press »OK« to confirm.
- 5 Press »i« to finish the setting.

Parental lock

You can block any station. The screen goes black.

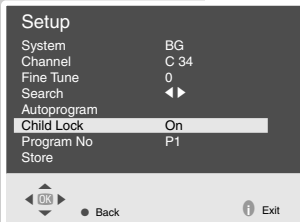

- 1 Press »i« to open the info menu.
– The info menu appears.
- 2 Select »Setup« by pressing »P+« or »P-« and confirm with »OK«.
- 3 Select »Child Lock« with »P+« or »P-«.
- 4 Press »◀« or »▶« to activate or deactivate the parental lock (On) or (Off).
- 5 Press »i« to finish the setting.

DVD MODE

Special DVD features



Your DVD player provides you with perfect digital video playback of studio quality.

It also provides superb cinema-quality audio playback – in stereo or with digital multi-channel sound – depending on the type of DVD and audio system or stereo television.

Other features of DVD video include the choice of audio channel and language, choice of subtitle language, and various camera recording angles. Your DVD player is suitable for DVDs with regional code 2.

As well as DVDs, it can also play MP3 CDs, JPEG coded (photo) CDs, video CDs, S-video CDs and audio CDs.

Disc formats

Your DVD player can play back CD-R, CD-RW, VCD 2.0, Super-VCD, DVD R, DVD RW discs.

Due to the difference in quality of the recording media and the quality of the recording itself, it can occasionally happen that a home-made DVD or CD cannot be read. This does not indicate a malfunction of the DVD player.

You have to finalise your own CD-R and CD-RW recordings.

Note that the settings of your CD burning program must meet the ISO 9660 standard in order to create a CD-R or CD-RW.

When MP3 or JPEG CDs are played back, individual tracks/pictures may be skipped or incorrectly played back and displayed. This can be due to the disc configuration, the encoder software or the hardware used for the recording.

Audio CDs (CDDA) correspond to the specification and bear the corresponding logo. Copy-protected CDs do not meet this specification and do not bear the corresponding logo. These CDs can cause playback errors.



DVD MODE

Preparation

Switching on

- 1 Switch on the television and press »**TV/DVD**« to select DVD mode.
- 2 If an audio system or an AV receiver is connected to the device, switch it on and select the audio input for the device.

Inserting a disc

- 1 Open the disc compartment by pressing »**▲**«. – The disc compartment opens.
- 2 Insert the disc you want to play in the disc compartment with the label facing upwards.
- 3 Close the disc compartment with »**▲**«. – The disc tray retracts again and the disc is scanned.

Notes:

Playback of a DVD, VCD, SVCD or audio CD (CDDA) starts automatically.

The file browser appears if an MP3 or JPEG CD is inserted.

If the »  « symbol appears on the television screen, the selected function is not possible with this disc.

Removing discs

- 1 Press »**▲**« to open the compartment and take out the disc.

DVD MODE



DVD features

You can recognise a DVD by the logo on the label.

Depending on the content of the DVD, the discs contain one or more titles.

Each title may contain one or more chapters. Titles and chapters can be selected easily and conveniently.

You can control and direct playback of a DVD using the menu of the DVD player on the television screen.

Special DVD features

DVDs have a title menu which provides an overview of the available titles and the passages they contain.

Some of the DVD player's functions, such as slow motion, freeze-frame and auto-play, can also be controlled by the DVD itself. It is therefore possible that the freeze-frame function, for example, cannot be selected during certain scenes.

Many DVDs have audio tracks recorded in up to eight languages. This enables you to select the language you prefer.

Many DVDs are recorded by the manufacturer with subtitles in several languages. You can select subtitles from up to 32 different languages.

Since films are released in different parts of the world at different times, all DVD players world-wide are given a regional code. The regional code for your DVD player is 2.

DVDs may also be given a supplementary regional code. If you insert a DVD with a code different to that of the DVD player, a reference to the regional code appears on the television screen. The DVD player will not be able to play back the DVD.

S-VCD/VCD features

You can recognise S-VCD/VCDs (video CDs) by the logo on the label.

Depending on the contents of the S-VCD/VCD (films, music videos etc.), the discs may carry one or more tracks.

Like audio CDs, S-VCDs/VCDs have a track structure.

S-VCDs/VCDs can be created using the PBC (playback control) system for track navigation. This depends on the processing and burning software used.

You can control and direct playback of the S-VCD/VCD using the menu on the television screen.

You cannot select some of the functions (slow motion, camera angle, marking scenes) when you are playing an S-VCD/VCD. This depends on how the S-VCD/VCD was created.

Depending on how they were created, S-VCDs can have various subtitles and dubbed languages.



DVD MODE



MP3 CD features

MP3 stands for MPEG-1 Audio Layer 3 and arises from the Motion Picture Expert Group (MPEG) Standard which was developed for compressing film data.

The MP3 format enables audio files to be saved on a computer with a sound quality similar to that of a CD. This only requires approx. 10% of the original data quantity. The standard encoding bit rate for MP3 files is 128 kbps. Generally, the higher the bit rate of an MP3 file, the better the sound quality.

Most MP3 files on the Internet are encoded at 128 or 160 kbps. 160 kbps is considered CD quality.

MP3 files can be downloaded from the Internet and then burned onto a CD-ROM disc. Your DVD player can read the ID3 tag from the file header, which contains information on title and artist, and display this in the info menu/status display.

MP3 CDs contain sound recordings. They can be played in the normal manner on an audio system. The digital signals transmitted during MP3 playback are PCM coded, regardless of the audio output setting. The signals are output with the same data rate as the music source (possibilities are: 32 kbps – 320 kbps, ideal: 128 kbps).

MP3 files can be organised into folders and subfolders, similar to files within a PC.

JPEG CD features

JPEG stands for Joint Picture Experts Group. This process was designed to compress picture files.

JPEG files can be burned onto a CD along with other file types. Such CDs are known as file CDs or mixed mode CDs. For example, the CD could contain MP3 files (audio) and JPEG files (for example to display album covers).

The files on a JPEG CD can be organised in directories. This structure is similar to that of an MP3 CD.

JPEG CDs only contain data in the compressed JPEG format. This is mostly data from digital cameras or from imaging programs. The data (images) can be displayed individually or in sequence in a slide show.

Audio CD features

An audio CD is identified by this logo.

Audio CDs contain only sound recordings. They can be played in the normal manner on an audio system.

The individual tracks are stored in a sequence. There are no folders.



DVD MODE

Using a DVD, video CD or audio CD

Depending on the disc being used, some functions may not be available.

Playing back a title

- 1 After the disc compartment closes and the disc is scanned, playback starts automatically.
- 2 To pause playback (freeze-frame), press »▶||◀.
- 3 Press »▶||◀ to resume playback.
- 4 Press »■◀ to interrupt playback.
- 5 Press »▶||◀ to resume playback.
- 6 End playback with »■◀ (press twice).

Note:

Depending on the disc being used, you may have to select chapters or titles on the disc using »P+◀, »P-◀, »◀◀ or »▶◀ and press »OK◀ to activate the or »▶||◀ to start playback.

Calling up information*

You can call up information on the title, chapter and playing time for display on the screen.

- 1 Press »GO TO◀ twice to display the info menu.
 - You will see information on:

DVD, VCD	Disc type
Title 01/02	The current title and available titles
Chapter 03/18	The current chapter and available chapters
2:05:00	Elapsed playing time of the chapter
0:03:50	Remaining playing time of the chapter
- 2 Repeatedly press »GO TO◀ to hide the info menu.

Calling up the zero setting function*

You can select a playback position to the precise second with the zero setting function.

- 1 Press »GO TO◀ three times to display the zero setting function.
- 2 Select the time, title and chapter input with »◀◀ or »▶◀.
- 3 Using the numerical buttons »1...0◀ enter the time, title or chapter number and press »OK◀ to confirm.
- 4 Playback starts at the position you entered.

* DVD or video CD only

DVD MODE

Selecting the camera angle and repeat function*

Many DVDs contain scenes or passages which were filmed several times from different camera angles. You can choose from among these different angles.

You can repeat the current chapter or title with the repeat function.

- 1 Press »GO TO« four times to display the camera angle and repeat function.
- 2 Select the »Angle« or »Repeat« function with »◀« or »▶«.
- 3 Press »OK« to select the camera angle or repeat function you want.
- 4 Repeatedly press »GO TO« to hide the menu.

Selecting titles and chapters using the disc menu*

If a disc contains several titles and/or chapters, you can select them. If a disc contains several tracks/chapters, this can be seen by »Title« and »Chapter« in the info menu.

- 1 Call up the contents of the disc with »DVD MENU« (Disc Menu) or »TITLE« (Title Menu).
– If the disc has a title menu it will appear on the screen.
- 2 Select tracks or chapters with »P+«, »P-«, »◀« or »▶« and activate with »OK«.
– Playback of the selected title or chapter begins.

Selecting chapters in steps (SKIP)

- 1 To select the next chapter, press »▶|« during playback.
- 2 Press »|◀◀« to select the previous chapter.
– Playback of the selected chapter begins.

Pausing and resuming playback

The playback of a DVD can be interrupted at any point and then resumed from the same place.

- 1 Interrupt playback by pressing »■« once only.
- 2 Press »▶||« to resume playback at the point where it was interrupted.

Ending playback

You can stop playback at any point by pressing »■« twice.

* DVD or video CD only

DVD MODE

Additional functions during DVD or video CD playback

Notes:

The sound is muted during the "Frame search", "Slow motion" and "Freeze-frame" functions.

Depending on the disc, some functions cannot be selected.

Frame search

Several different speeds are available.

- 1 Select the playback speed during playback by pressing »◀◀◀◀ or »▶▶▶▶◀.
- 2 Press »▶▶▶▶ to resume playback.

Slow motion

You can choose between different speeds (1/2, 1/4, 1/6, 1/8, forwards or reverse).



- 1 Press »▶▶▶▶ during playback.
- 2 Select the slow motion speed by pressing »◀◀◀◀ or »▶▶▶▶◀.
- 3 Press »▶▶▶▶ to resume playback.

Freeze-frame (Pause)

- 1 Press »▶▶▶▶ during playback.
- 2 Press »▶▶▶▶ to resume normal playback.

Enlarging the picture (zoom)

This function allows you to enlarge various picture sections. The picture enlargement options are selected in the sequence: 1, 2, 3, 4, Off (normal size).

- 1 During playback or pause, press »◀ repeatedly.
– Part of the picture is enlarged.
- 2 Move the picture section on the screen with »P+◀, »P-◀, »◀◀◀◀ or »▶▶▶▶◀.
- 3 Switch back to "normal" picture size with »◀.

DVD MODE

Using an MP3 CD or JPEG CD

Playback

- 1 After the disc compartment has closed and the MP3 CD or JPEG CD has been scanned, the File Browser (Contents menu) of the disc is displayed.
- 2 Press »P+«, »P-«, »◀« or »▶« to select the track you want to hear and then »OK« to start playback.
- 3 Press »▶||« to pause playback.
- 4 Press »▶||« to resume playback.
- 5 End playback by pressing »■«

Selecting specific tracks using the numerical buttons

- 1 During playback, select the track with »1 ... 0« and press »OK« to confirm.
– Playback begins with the selected track.

Selecting a track in steps (SKIP)

- 1 Select the next track by pressing »▶|« during playback.
- 2 Select the previous track by pressing »|◀«.
– Playback begins with the selected track.

Additional JPEG CD playback functions



Adjusting the picture display

The pictures can be rotated or reversed.

- 1 During playback, press »◀« or »▶« to rotate the pictures by 90°.
- 2 During playback, press »P+« or »P-« to reverse the pictures.

Enlarging/reducing the picture (Zoom)

This function allows you to enlarge or reduce various picture sections.

- 1 During playback or pause, press »« repeatedly.
– Part of the picture is enlarged.
- 2 Move the picture section on the screen with »◀« or »▶«, »P+« or »P-«.
- 3 Switch back to "normal" picture size with »«.

DVD MODE

Creating and playing a playlist

This function enables you to create a playback list for all types of discs.

Up to 12 titles, chapters or tracks can be stored.

- 1 Place a disc in the tray.
- 2 Open the »Program Input« menu by pressing »PROGRAM«. – Depending on the type of disc in use the program menu appears, and position 1 is marked.
- 3 Enter the number of the title, chapter or track with »1...0«.
- 4 Select the next input position with »◀«, »▶«, »P+« or »P-«.

Note:

Delete all entries by selecting »Clear All« using »P+«, »P-«, »◀« or »▶« and press »OK« to confirm.

- 5 To play back the track memory, select »Play Program« with »P+«, »P-«, »◀« or »▶« and press »OK« to confirm. – Playback of the program starts.
- 6 Press »■« to end playback.

Program Input		Title/Chapter	
1	4	7	10
2	5	8	11
3	6	9	12
Play Program		Clear All	

DVD SETTINGS

No settings are necessary for operating the DVD unit of the television set.

However, in the menu, you can change the language, select sound effects, select the picture format and make many other settings.

Selecting the menu

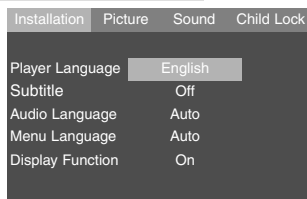

- 1 Press »**DVD SETUP**« to open the menu.
– The menu appears.
- 2 Select the menu with »◀« or »▶« and press »**OK**« to activate.
– The selected menu item is highlighted.
- 3 Select the item with »**P+**« or »**P-**« and press »**OK**« to confirm.
– The setting options are displayed.
- 4 Select the function or setting using »**P+**« or »**P-**« and press »**OK**« to confirm.

Note:

Press »**P+**« to go back one step in the menu items.

- 5 Press »**DVD SETUP**« to quit the menu.

Menu options

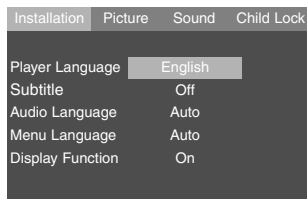

Voice

- Player Language: – Select the on-screen menu "language".
- Subtitle: – Select and display subtitles.
- Audio Language: – Select the dubbing "language".
- Menu Language: – Select the language of the DVD menus.
- Display Function: – Switch function displays (e.g. **II** Pause) on/off.

Picture menu

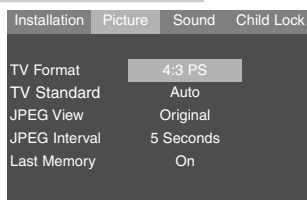

- TV Format: – Set the picture format (4:3 PS (PanScan), 4:3 LB (Letterbox), 16:9).
- TV Standard: – Select the TV standard (NTSC, PAL, Auto).
- JPEG View: – Select the display of JPEG pictures (Original, Screen size).
- JPEG Interval: – Select the display time of JPEG pictures (5, 10, 15 seconds).
- Last Memory: – Switch on/off.

DVD SETTINGS

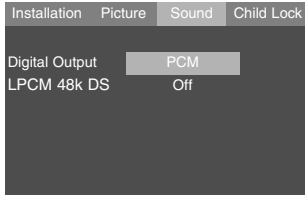

Sound menu

- Digital Output: Set the digital output (Off, Raw (Original format), PCM).
- LPCM 48k DS: Set the scanning rate 48 kHz (setting: On) or 98 kHz (setting: Off).

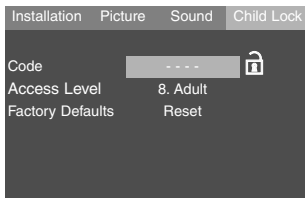

Parental lock

- Code: Enter the password and press »OK« to confirm. (After you enter a randomly selected numerical code the access level can no longer be changed.)
- Access Level: Select access level (1 to 8). (The lock symbol must be opened using a code.)
- Factory Defaults: Return to default settings.

USING EXTERNAL DEVICES

Decoder or satellite receiver

A decoder is needed if the television receives encoded programs from a privately operated station.

Connecting a decoder or satellite receiver

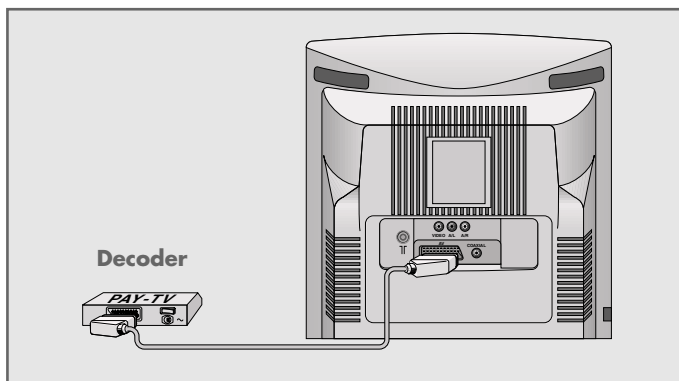

- 1 Connect the »AV1« socket on the television set and the corresponding socket on the decoder using a EURO-AV cable.

Notes:

A satellite receiver can also be connected to this socket. If you want to use both a satellite receiver and a decoder, the decoder must be connected to the satellite receiver.

Using a decoder

- 1 Switch on the television and the decoder.
- 2 Select the »AV1« preset channel by pressing »AV« repeatedly until »AV1« appears on the screen.

Headphones

Connecting the headphones

- 1 Insert the headphone jack (3.5 mm \varnothing jack plug) in the headphone socket on the television.

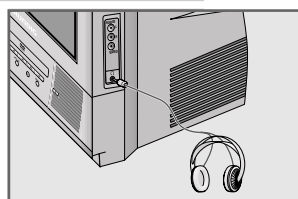

USING EXTERNAL DEVICES

Video recorder or set-top box

Connecting a video recorder or set-top box

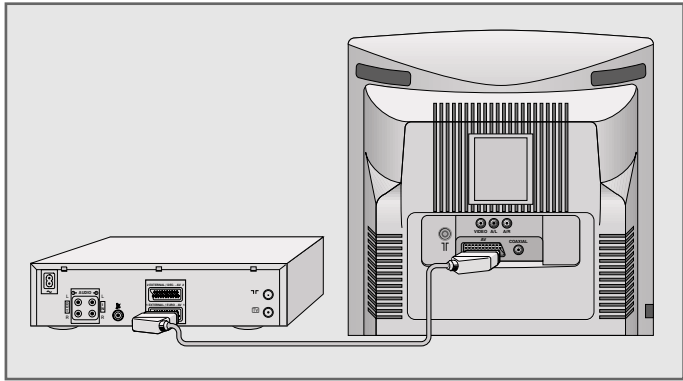

- 1 Connect the »AV1« socket on the television to the corresponding socket of the video recorder or set-top box using a Euro-AV (Scart) cable.

Using a video recorder or set-top box

- 1 Switch on the video recorder or set-top box and select the desired function.
- 2 Select the »AV1« channel using »AV«.
 - You can hear and see the video and audio information from the video recorder or the set-top box on the television set.

Notes:

You can connect an external RGB device (set-top box) to the Euro-AV1 socket. However, you will need to use a fully assigned Euro-AV cable for this.

The signal of the built-in DVD player is not transmitted via the Euro-AV socket.

Using an S-Video device

If you have a device with an S-Video output, you can connect it using a EURO/AV (Scart) cable to the »AV1« socket.

Press »AV« to select the »AV1-S« channel.

USING EXTERNAL DEVICES

Camcorder

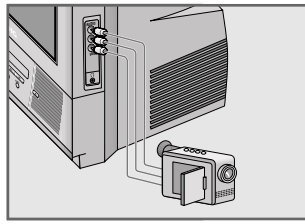

Connecting a camcorder

- 1 Connect the yellow socket (VIDEO – picture signal) on the television and the corresponding socket on the camcorder (VHS, Video 8) using a cinch cable.
- 2 Connect the white and red sockets (L AUDIO R – sound signal) on the television and the corresponding sockets of the camcorder with a cinch cable.

Using a camcorder (VHS, Video 8)

- 1 Switch on the camcorder, insert a cassette and start playback.
- 2 Select the »AV2« channel (for VHS, Video 8) by pressing »AV« repeatedly until »AV2« appears on the screen.
 - You will see the picture and hear the sound of the camcorder on the television.

USING EXTERNAL DEVICES

Connecting a multi-channel amplifier or digital two channel audio system

The digital multi-channel sound of a DVD can best be decoded and played back with a multi-channel audio/video amplifier (Dolby* digital decoder or DTS).

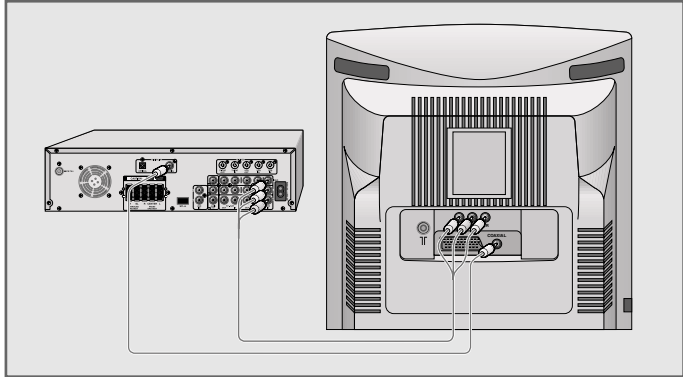

- 1 Plug a standard cinch cable into the cinch socket »**COAXIAL**« (digital audio signal) on the television and into the corresponding socket on the digital multi-channel amplifier.
- 2 Plug a standard cinch cable into the cinch sockets »**VIDEO**« (picture signal), »**A/L**« (left audio signal) and »**A/R**« (right audio signal) on the television and into the corresponding sockets on the digital multi-channel amplifier.

Note:

Even if you are using a digital connection, you should still make an analogue audio connection as it is possible, depending on the disc type, that no signal can be output via the »**COAXIAL**« socket.

* Manufactured under licence from Dolby Laboratories Licensing Corporation. "Dolby", "Dolby Pro Logic", "Dolby Digital" and the double-D symbol "DD" are trademarks of the Dolby Laboratories Licensing Corporation. Copyright 1992 Dolby Laboratories, Inc. All rights reserved.

SPECIAL SETTINGS

Setting television channels

This setting is only necessary if a new channel comes on air and you do not want to change the order of your channels. The television channel can be set directly or using the search.

Setting channels using the search

- 1 Press »i« to open the »Main Menu«.
- 2 Select »Setup« with »P+« or »P-« and confirm with »OK«.
– The »Setup« menu appears.
- 3 Select »Program No« with »P+« or »P-« and set the preset channel with »◀« or »▶«.
- 4 Select »Search« with »P+« or »P-« and start the search with »◀« or »▶«.
– If a strong station signal is received, the search is interrupted and the picture appears. Repeat the search until the channel you want appears on the screen.

Note:

The current system is automatically displayed in the »System« line.

- 5 Select »Store« with »P+« or »P-« and confirm with »OK«.
– The »Stored« message appears.

Note:

To set other television stations, repeat steps 3 to 5.

- 6 Press »i« to finish the setting.

Fine tuning television channels

The television automatically tunes itself to the best possible reception. You may need to carry out manual fine tuning in areas where there is poor reception.

- 1 Press »i« to open the »Main Menu«.
- 2 Select »Setup« with »P+« or »P-« and confirm with »OK«.
– The »Setup« menu appears.
- 3 Select »Fine Tune« with »P+« or »P-« and set it with »◀« or »▶«.
- 4 Select »Store« with »P+« or »P-« and confirm with »OK«.
– The »Stored« message appears.
- 5 Press »i« to finish the setting.

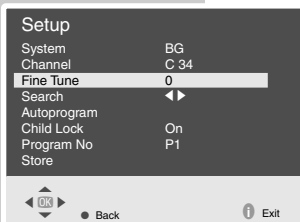
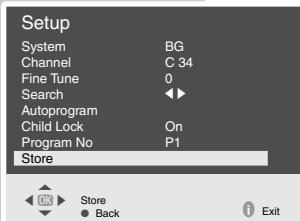
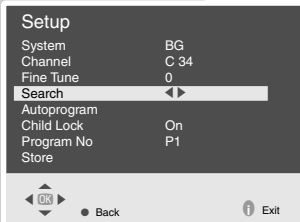

SPECIAL SETTINGS

Setting the television channels by entering the channel numbers

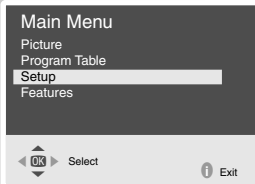

- 1 Press »i« to call up the »Main Menu«.
- 2 Select »Setup« with »P+« or »P-« and confirm with »OK«. – The »Setup« menu appears.
- 3 Select »Program No« with »P+« or »P-« and set the channel with »◀« or »▶«.
- 4 Select »Channel« with »P+« or »P-« and confirm with »OK«.
- 5 Press »OK« to choose between »S« (special channel) and »C« (channel).
- 6 Press »◀« or »▶« to switch up and down channels or use »1...0« to enter the channel number directly.

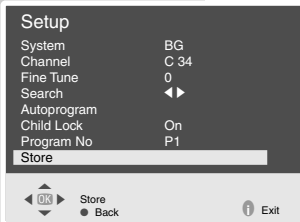
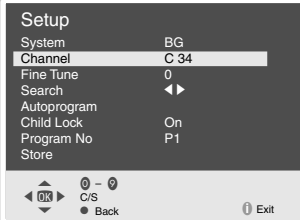

Note:

The current system is displayed in the »System« line.

If the colour or sound are incorrect, select »System« with »P+« or »P-«. Make the necessary adjustments with »◀« or »▶«.

- 7 Select »Store« with »P+« or »P-« and confirm with »OK«.

Note:

To set other television stations, repeat steps 3 to 7.

- 8 Press »i« to finish the setting.

Re-tuning all television channels

You can re-tune all the television stations, for example if you move to another town.

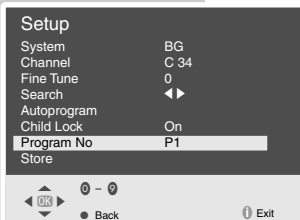

- 1 Press »i« to open the »Main Menu«.
- 2 Select »Setup« with »P+« or »P-« and confirm with »OK«. – The »Setup« menu appears.
- 3 Select »Program No« with »P+« or »P-« and using »◀« or »▶« enter the channel numbers from the point they should be saved.
- 4 Select »Autoprogram« with »P+« or »P-« and confirm with »OK«. – The »Autoprogram« menu appears.
- 5 Select the country using »P+«, »P-«, »◀« or »▶« and confirm with »OK«.
- 6 Press »OK« to start the search. – The automatic search may last a few minutes, depending on the number of television channels received.

Note:

You can interrupt the search by pressing »i«.

INFORMATION

Technical data

Mains voltage:	230 V, 50 Hz
Power consumption:	2 W in standby, 65 W in operation
Sound output:	2x6 W music power
Reception range:	C01 ... C99, special channels S01 ... S41, frequency band 1 ... 4
Preset channels:	100 and 3 AV
Disc formats:	DVD R (+/-), DVD RW (+/-), CD-R, CD-RW
Media formats:	DVD video, audio CD, video CD, S-Video CD, CD-ROM (MP3, JPEG)

Service information for dealers

The product complies with the following EU directives: 73/23/EEC directive for electrical equipment to be used within defined voltage ranges. 89/336/EEC directive on electromagnetic compatibility.

The television set complies with the following standards: EN 60065, EN 55013, EN 55020.

General instructions for laser devices

Your system is a CLASS 1 LASER PRODUCT. This means that the laser is designed in such a way as to ensure that the maximum permissible emission value cannot be exceeded under any circumstances.

Caution:

If operating devices or methods other than those specified here are employed, it may lead to dangerous exposure to emissions.

This device emits laser radiation. Because of the danger of eye injuries, the unit may only be opened or serviced by trained personnel.

If settings other than those specified here are employed or OTHER PROCEDURES are carried out, this may lead to dangerous radiation exposure.



CLASS 1
LASER PRODUCT



This product contains components which are covered by certain U.S. patents or for other reasons are considered intellectual property of the Macrovision Corporation and other proprietors. Use of this protected technology must be approved by the Macrovision Company and is only permissible for private presentation at home or for other limited applications, where no special permission has been granted by Macrovision. Reproduction or disassembly of the device is prohibited.

Manufactured with permission from Dolby Laboratories. The "Dolby" label and the double-D logo "DD" are trademarks of Dolby Laboratories. Confidential unpublished material.
©1992-1997 Dolby Laboratories, Inc. All rights reserved.

During playback of DTS-coded CDs and DVDs, a high noise level is produced at the analogue stereo outputs. In order to avoid possible damage to the audio system, the user should take appropriate preventive measures when the stereo outputs of the DVD player are connected to an amplification system. For DTS Digital Surround playback, an external 5.1-channel DTS Digital Surround decoder must be connected to the digital output (S/PDIF) of the DVD player.

DTS and DTS Digital Out are trademarks of Digital Theater Systems, Inc. All rights reserved.

INFORMATION

Troubleshooting

If the remedies given below do not work, please consult an authorised GRUNDIG dealer. Please bear in mind that malfunctions can also be caused by external devices such as video recorders or satellite receivers.

TV operation

Fault	Possible cause	Remedy
Screen lit (snow), but no station	Antenna cable	Is the antenna cable connected?
	No television station programmed	Start the station search
Poor picture contrast	Picture settings incorrectly set	Adjust the brightness, contrast or colour setting
	Problem at station	Test with another channel
Interference to picture and/or sound	Interference from other devices	Change the position of the devices
Ghosting, reflection	Channel setting	Automatic or manual channel setting/fine tuning
	Antenna	Have antenna cable or system checked
No colour	Colour intensity at minimum	Turn up the colour
	TV standard setting (if setting option is available)	Select the correct colour standard
	Problem at station	Test with another channel
Inappropriate colour, colour spots	Strong magnetic field due, for example, to loudspeakers	Move the loudspeakers away from the television If colour spots remain, switch off the television set at the mains and switch on again after 10 minutes
Picture but no sound	Volume set to minimum	Turn up or switch on the volume
	Problem at station	Test with another channel
Teletext missing or faulty	Television station (has no teletext) or antenna system	Test another channel for fine tuning and ghosting
	Station signal too weak	Check the antenna system
Remote control does not work	No optical connection	Point the remote control at the television set
	Remote control batteries	Check the batteries, change if necessary
	Operating condition undefined	Switch off the television with the main power button for approximately 2 minutes
The picture is unrecognisable after switching on the television	Parental lock has been activated	Deactivating the parental lock

DVD mode

Fault	Cause/Remedy
The disc compartment will not open, picture/sound problems.	Switch the DVD player off and back on again using the power switch. »Ⓚ«
Distorted picture	Make sure that there are no fingerprints on the disc, follow the cleaning instructions.
DVD/CD cannot be played	Check if the label on the disc is facing upwards.
	Clean the disc.
	Check if the disc is damaged by testing another disc.
No sound	Try another playback source.
	Use an external decoder for DTS audio formats.
No sound at the digital output.	The scanning rate was set to 96 kHz. Set the scanning rate to 48 kHz as described on page 28.

Cleaning discs

Wipe the dirty disc with a cloth from the centre outwards in a straight line.

Do not use any solvents such as benzene, thinners, conventional cleaner or anti-static spray for vinyl records.

Software information

We wish to point out explicitly that only operating software authorised by GRUNDIG is permissible for the DVD player. This operating software is available from specialist dealers or from the Grundig web sites www.grundig.com or www.grundig.de. Any instance of operating software from a dubious Internet source being loaded to the device will impair functioning and also, since it is an unauthorised intervention, invalidate any claims under the guarantee.

GRUNDIG will refuse to refund any costs resulting in such cases. Any repair costs in such cases, even those occurring within the guarantee period, are to be paid by the customer.

INFORMATION

Additional Information for units sold in the UK.

Units sold in the UK are suitable for operation from a 240V ac, 50Hz mains supply.

The range of multi-system receivers is built to work in most European countries. However, the mains plug and socket system for the UK differs from many European countries.

This appliance has been supplied with a fitted, non-removable, approved converter plug for use in the UK. This converter plug is fitted with a 5A rated fuse.

In case this appliance is supplied with a moulded 2-pin Euro plug only, which is unsuitable for UK operation, this must be cut off and immediately disposed of. An approved 13A, 3-pin UK plug should then be fitted by a qualified electrician.

Note:

The severed Euro plug must be destroyed to avoid a possible shock hazard should it be inserted into a socket elsewhere.

If a non-rewireable 3-pin plug or a rewireable 13A (BS1363) 3-pin plug is used, it must be fitted with a 5A ASTA or BSI approved BS1362 fuse. If any other type of plug is used it must be protected by a 5A fuse either in the plug, or at the distribution board. If this type of plug becomes defective, ensure that the fuse is removed before disposal, to eliminate potential shock hazard.

If it is necessary to change the fuse in the non-rewireable plug, the correct type and rating (5A ASTA or BSI approved BS1362) must be used and the fuse cover must be refitted. If the fuse cover is lost or damaged, the lead and plug must not be used until a replacement is obtained. Replacement fuse covers should be obtained from your dealer.

Important:

The wires in the mains lead are colour coded in accordance with the following code:

BLUE – NEUTRAL

BROWN – LIVE

As the colours of the wires in the mains lead of your appliance may not correspond with the coloured marking identifying terminals in your plug, proceed as follows:

Connect the BLUE coloured wire to plug terminal marked with the letter "N" or coloured black.

Connect the BROWN coloured wire to the plug terminal marked with the letter "L" or coloured red.

In no circumstance must any of the wires be connected to the terminal marked with the letter "E", earth symbol "⏏", coloured green, or green & yellow.

Free Manuals Download Website

<http://myh66.com>

<http://usermanuals.us>

<http://www.somanuals.com>

<http://www.4manuals.cc>

<http://www.manual-lib.com>

<http://www.404manual.com>

<http://www.luxmanual.com>

<http://aubethermostatmanual.com>

Golf course search by state

<http://golfingnear.com>

Email search by domain

<http://emailbydomain.com>

Auto manuals search

<http://auto.somanuals.com>

TV manuals search

<http://tv.somanuals.com>