

GRUNDIG

SATELLITE TV RECEIVER + Antenna-Positioner

STR 400 AP

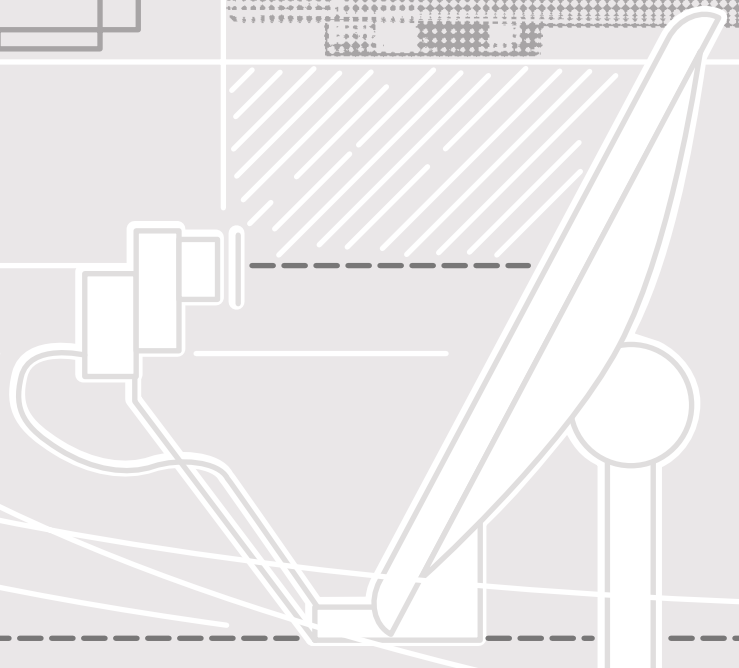
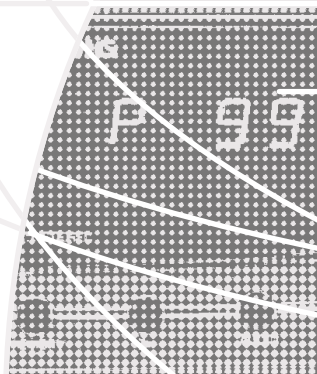

Contents

Installation and Safety Precautions

Installation and Safety Precautions.....	3
Protect Your Environment!	3

Connection Examples

Connection Examples	4
---------------------------	---

Buttons on the Remote Control Handset

Buttons on the Remote Control Handset	6
---	---

Buttons and Connections on the Receiver

Front of Unit	8
Rear of Unit.....	9

Important Information

General	10
Button Lock.....	10
Connecting the SAT Receiver to the Television.....	10
16:9 Switching	10
Selecting the Aerial Input.....	10
Hint	10

Basic Adjustment of the Polarmount Aerial

General	11
Setting the Zero Position and Limits	12
Adapting the Receiver to Different Aerial Systems with Different Feed-in Systems (LNC's)	12
Adapting the Polarizer.....	15
Storing the Satellite Position in Memory.....	16
Adjustment Run	16

Buttons and their Functions on the Receiver

General	17
○ P/F – Selecting Programme/Frequency.....	17
○ V/H – Selecting Vertical/Horizontal Polarisation and Input A/B	18
○ VIDEO – Adjusting the Video Deviation	18
○ AUDIO – Mono/Stereo and Sound Carrier Switching	18
○ </> – Down/Up Setting Buttons	18
○ MEMORY – Storing Data in Memory	18
○  – Aerial positioning/ designate the satellite position and station	19
○ RADIO – Selecting Radio Mode	20

The MODE Menu







Overview	21
COPY	22
SORT	22
0/12 VOLT – External Switching Voltage	22
SKEW – Polarizer Adjustment	22
SKEW ALL – Transferring the Skew Value	23
WIDE/NARROW – IF Bandwidth	23
DECODER	23
VID & AUD – Decoder Selection	23
NORM – Norm 1, 2 or 3	23
DEEMPH. – with MONO < >	23
MODULAT. – Adjusting the Modulator Channel.....	24
ATS – Automatic Tuning System	24
20:15 – Time and Date	24
CODE – Child Lock	24
DISPLAY – Display Brightness	25
ACTIVE/INACTIVE Programme Position	25

Datalink – Data Transmission

Datalink – Data Transmission	25
------------------------------------	----

Contents

Remote Control Functions

Direct Programme Selection	26
Radio/TV Switching	26
 Programme Select Buttons	26
 Buttons	26
 Standby	26
 Button	26
 Button	26
 Button	26
Switching the Remote Control Level	26

Universal Remote Control Handset

Universal Remote Control Handset.....	27
---------------------------------------	----

Timer Menu

Timer and Video Recorder	28
Calling Up the Menu	28
Timer Programming	28

Specification

Specification	30
---------------------	----

Pin Assignment of EURO-AV Sockets

Pin Assignment of EURO-AV Sockets	31
---	----

Installation and Safety Precautions

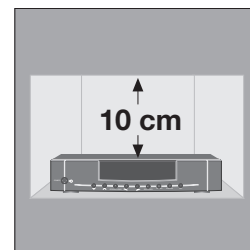
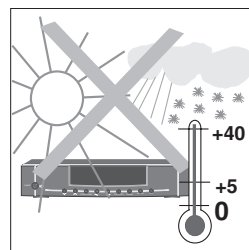
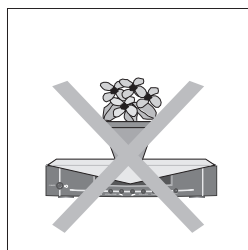
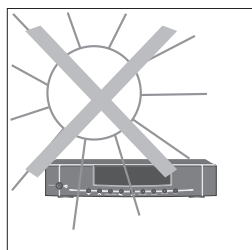
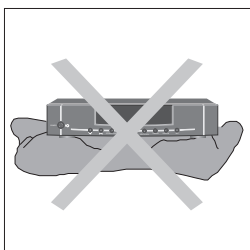

This satellite receiver is intended for reception of picture and sound signals. Any other application is expressly prohibited.

Make absolutely sure that your receiver is not exposed to dripping or splashing water. Protect the receiver from moisture.

In addition, ensure that the ventilation openings are never obstructed.

Do not place your receiver near sources of heat.

Heat build-up in the receiver is a source of danger and reduces the receiver's operating life.

When operating the receiver in a wall unit (or in a camper, for example), maintain distances of at least 10 cm – see illustration.

Even when switched off, the unit may be damaged by lightning striking the mains and/or aerial lead.

During a thunderstorm, you should therefore always disconnect the mains and aerial plugs.

Protect Your Environment!

Attention!

Do not throw used batteries from the remote control handset in the household waste. Dispose of the batteries at a special collecting point.

These operating instructions are printed on chlorine-free paper which helps to protect the environment.

For reasons of ecology, always switch off the receiver with its mains switch when it is not used for a longer time.

Always keep in mind: Even with the low standby power consumption of 10 W, you will consume 70 kWh within one year.

Connection Examples

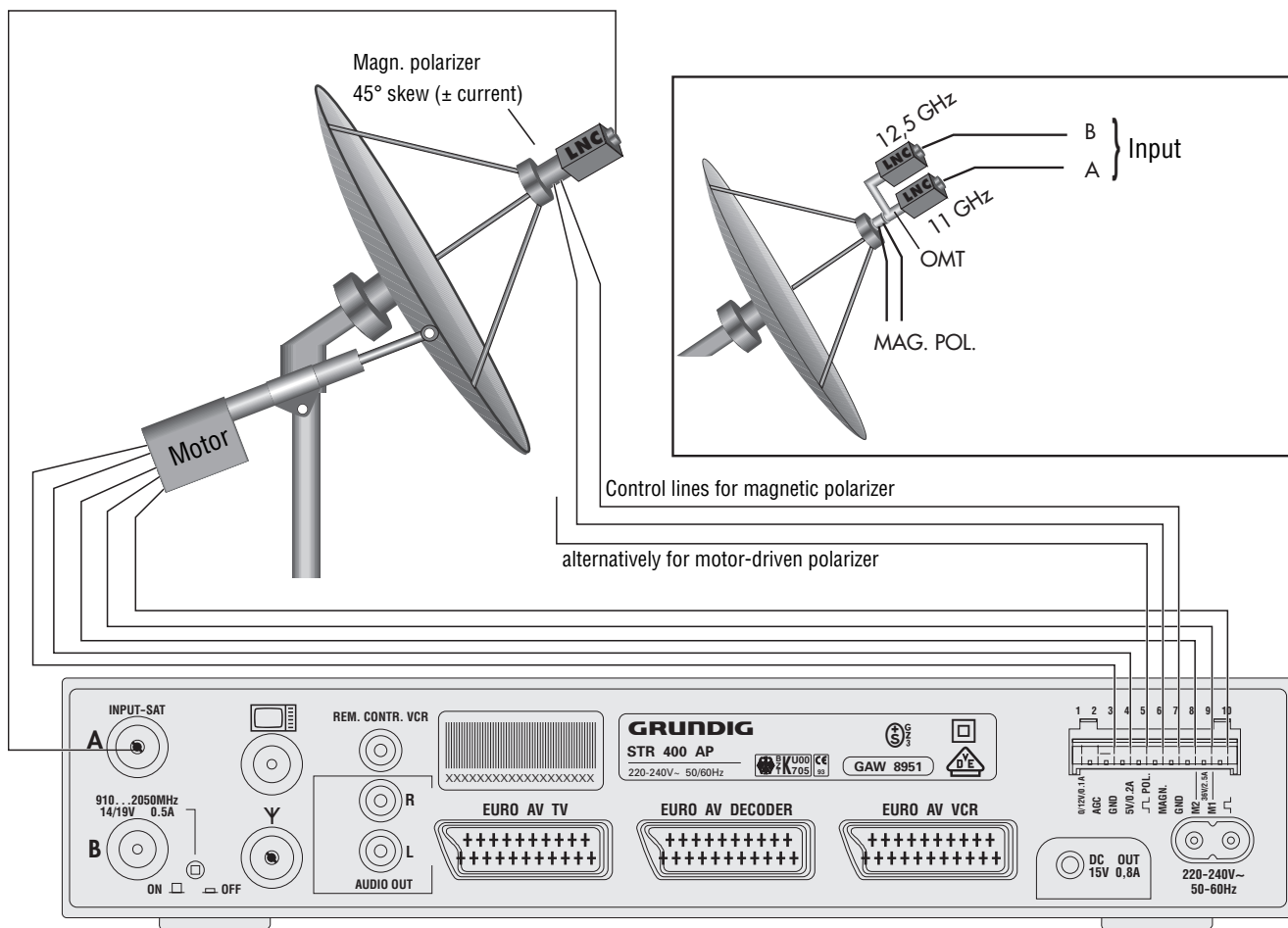

See also the system presentations in the chapter "Basic Adjustment of the Polarmount Aerial".

Connection Examples

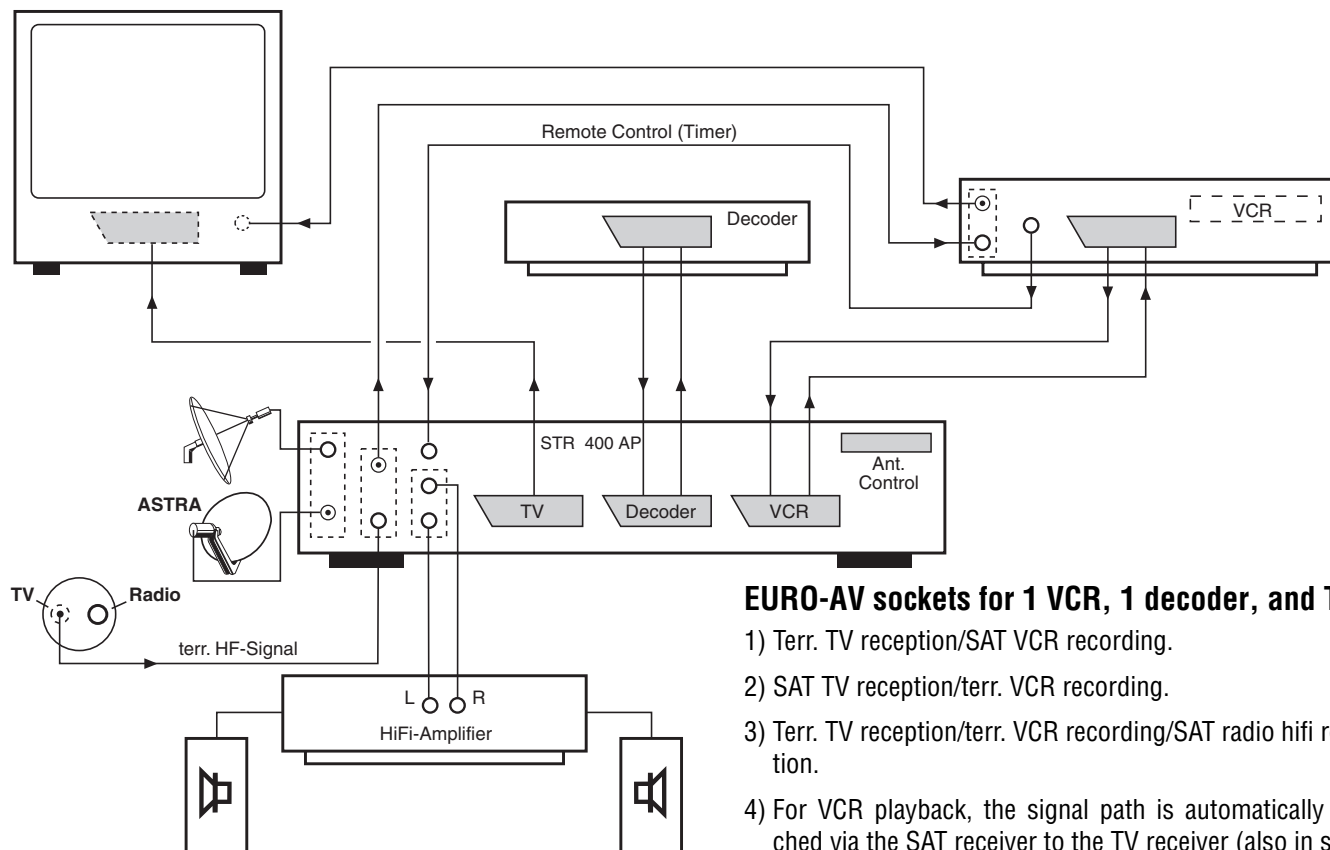

EURO-AV sockets for 1 VCR, 1 decoder, and TV

- 1) Terr. TV reception/SAT VCR recording.
- 2) SAT TV reception/terr. VCR recording.
- 3) Terr. TV reception/terr. VCR recording/SAT radio hifi reception.
- 4) For VCR playback, the signal path is automatically switched via the SAT receiver to the TV receiver (also in stand-by).

To 1) and 2)

If a decoder is connected, this is automatically switched on (evaluation of the switching voltage).

On decoders without switching voltage, this can be activated with respect to the programme position when programming the receiver.

Two aerial systems can be connected to the aerial inputs of the SAT receiver, for example:

Input A: Rotary system. Control takes place via the "Ant. Control." connections.

Input B: Fixed aerial being directed at the Astra satellite.

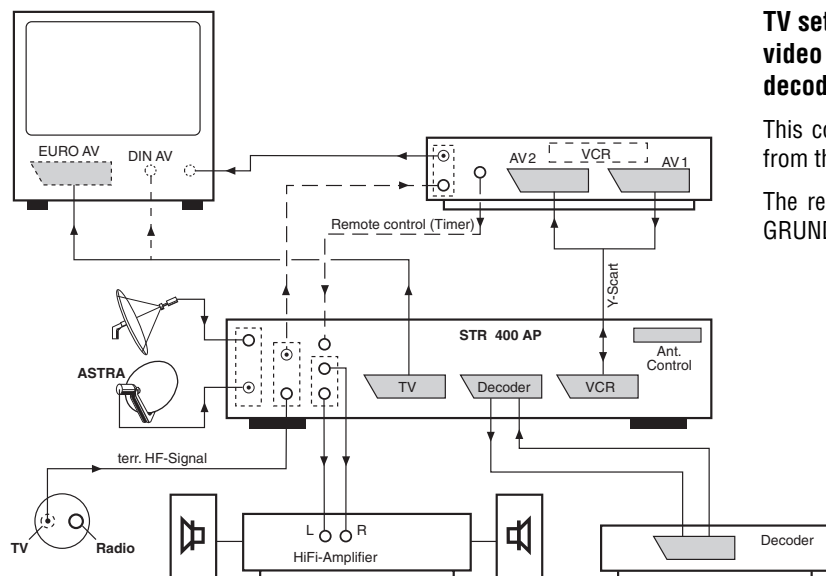

TV set with 1 EURO-AV- or 1 DIN socket / video recorder (VCR) with 2 EURO-AV sockets / decoder

This configuration is necessary if you wish to visualize info tables from the video recorder on the picture screen of the TV set.

The required cable is a special Y-Scart cable. Please consult your GRUNDIG after-sales service.

Buttons on the Remote Control Handset

Important operating functions and basic settings can be carried out with the universal remote control **TP 720 SAT**.

Please insert the battery included observing correct polarity. The marking for this is on the compartment bottom. Close the cover.

Change the exhausted battery in time. We cannot be held responsible for damages resulting from an exhausted battery.

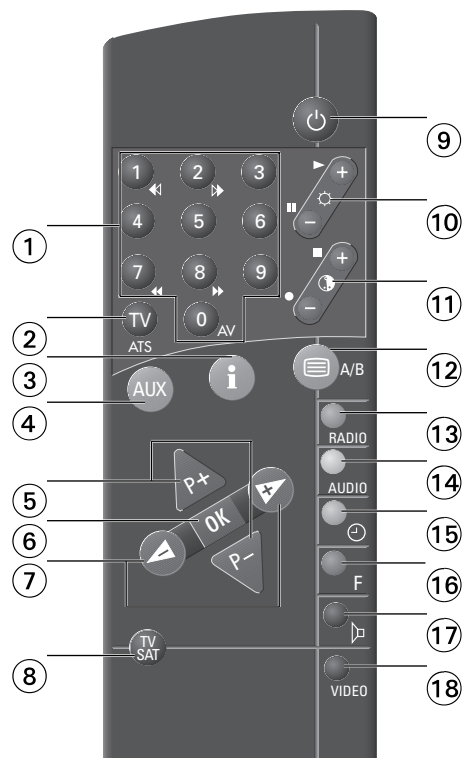















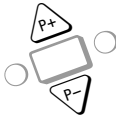





Buttons

① ①...⑨

- The desired programme position is directly selected with the numeric buttons, e.g. 123. When selecting a multi-digit programme position, the numbers are entered in sequence from left to right. For example, enter 1, 2, and 3. When you enter the digit 1, the following appears in the display:



- If no further entry is made, the unit switches automatically to the one-digit programme position 1. You can select up to 199 TV programme positions and 199 radio programme positions.
- Direct entry of the satellite's transmission frequency, e.g. 11325 MHz (MHz indication).
- In audio mode, direct entry of the sound carrier frequency, e.g. 7.02 MHz.
- Timer programming: Entry of date, start and stop time.
- Switching the receiver on from standby.

- ②  Certain TV sets select automatically the AV mode when switching on the SAT receiver. You can switch back to terrestrial reception mode by pressing the .
- ③  Opens the Timer menu and switches back to the current programme.
- ④  Shift button for switching to the second remote control level for a 2nd SAT receiver.**
- ⑤ 
 - Step-by-step programme position selection and switching on from standby.
 - In Timer menu: Selection of menu points.
- ⑥  Confirms and saves certain values (e.g. in the Timer menu).
- ⑦ 
 - In Timer menu: Selection of Timer positions.
 - In TV mode: Setting the volume level of the TV set.
 - After pressing the  button: Manual motor control for the Polarmount aerial.
- ⑧  Shift button for switching the remote control between SAT receiver and TV control mode. (This universal remote control handset can also be used for important functions of units of other manufacturers).**
- ⑨  Switches the receiver to standby. Only possible via the remote control handset.
- ⑩  Press together with the ⑧ **button: For setting the brightness of the TV set.
- ⑪  Press together with the ⑧ **button: For setting the colour contrast of the TV set.
- ⑫  Without function (Teletext function on certain TV sets).
- ⑬  Switches between SAT-TV and SAT-radio mode.
- ⑭  Without function (Teletext function on certain TV sets).
- ⑮  Without function (Teletext function on certain TV sets).
- ⑯  Activates manual motor run for the Polarmount aerial (motor control by means of the   buttons).
- ⑰  Press together with the ⑧ **button: For muting the sound of the TV set.
- ⑱  Shift button for switching the remote control between SAT receiver and video recorder mode. (This universal remote control handset can also be used for important functions of units of other manufacturers).**

** See also chapter "Universal Remote Control Handset".











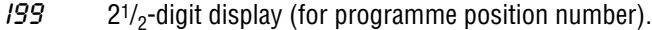
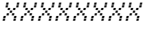



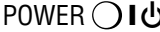

Buttons and Connections on the Receiver

Front of Unit

Attention!

Except of the buttons $\odot </>$ (31) and (33), and \odot Radio (35), all buttons are locked to prevent inadvertent operation. To clear the lock, press and hold down one of the locked buttons for more than 3 seconds.



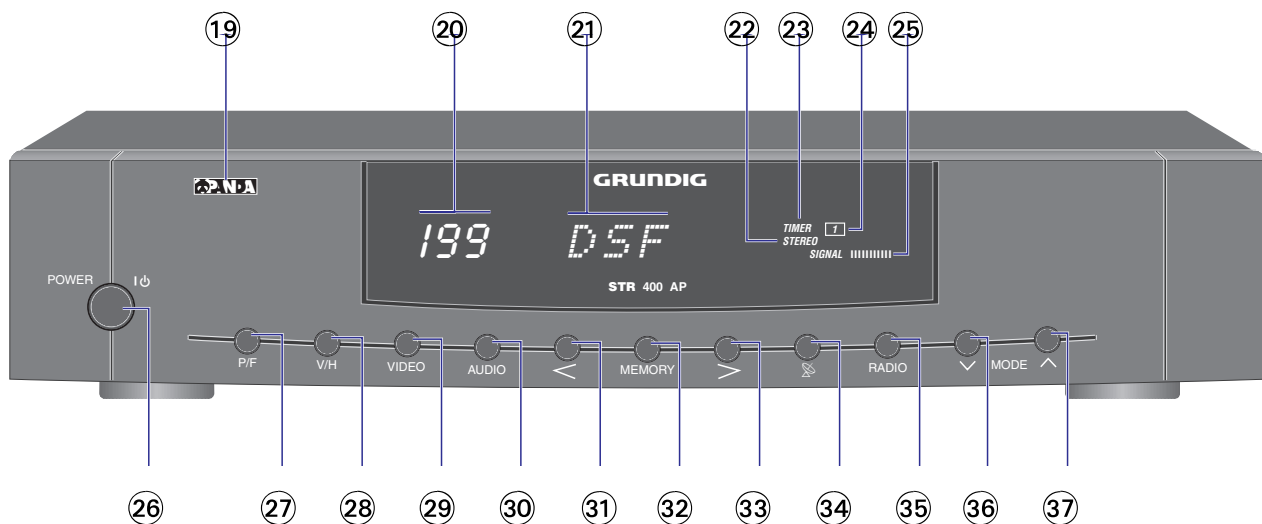

When switching the receiver off with the POWER $\odot \text{I}\text{O}$ switch, or to standby with the remote control handset, the lock is activated again.

- 19  PANDA logo of Panda/Wegener Communications Inc.. Award for excellent sound quality.
- 20  199 2¹/₂-digit display (for programme position number).
- 21  8-digit display
- 22  STEREO Stereo indication
- 23  TIMER Indication; lit when Timer menu is active.
- 24  1 2 3 4 Indication of active Timer position or programmed Timer positions.
- 25  SIGNAL ||||| Signal level indication.
- 26  POWER $\odot \text{I}\text{O}$ On/off switch. No disconnection from mains supply!
- 27  \odot P/F Programme position/frequency selection.
- 28  \odot V/H Vertical/horizontal polarization and tuner input selection A/B.
- 29  \odot VIDEO 16/22.5 and 25 MHz video frequency deviation and signal inversion selection.
- 30  \odot AUDIO Mono main carrier, mono subcarrier, and stereo Panda/Wegener carrier selection.
- 31  \odot < Downward step-by-step selection of programme positions and all adjustable data (... 3, 2, 1).
- 32  \odot MEMORY Storage of all preset data.
- 33  \odot > Upward step-by-step selection of programme positions and all adjustable data (1, 2, 3 ...).
- 34  \odot  Aerial positioning; submenu for aerial adjustment.
- 35  \odot RADIO SAT/TV and radio mode switching.
- 36  \odot MODE ∇ Multifunction button (see chapter "The Mode Menu").
- 37  \odot MODE \blacktriangle Multifunction button (see chapter "The Mode Menu").



Buttons and Connections on the Receiver

Rear of Unit

- ③⑧ INPUT A Connection for satellite aerial (input A).
- ③⑨ INPUT B Connection for satellite aerial (input B).
- ④⑩  ON...OFF On/Off button for LNC supply voltage.
- ④①  Y Terrestrial aerial input (VHF/UHF).
- ④②  Modulator aerial output (VHF/UHF).
- ④③ REM. CONTR. VCR Connection for remote control via a video recorder (see chapter "Timer Menu").
On reception of commands via this socket, the "VCR-REC" indication is flashing.
- ④④ AUDIO OUT R/L AF stereo output, left/right channel.
- ④⑤ EURO AV TV EURO-AV socket (output) for TV set, with RGB looping-through from decoder socket.
- ④⑥ EURO AV DECODER EURO-AV socket (input/output) for PAL/MAC decoder or additional video recorder.
- ④⑦ LNC-Power 14/18 V Individual 14/18 V LNC voltage adaption by ± 2 V (on the bottom of the receiver).
- ④⑧ EURO AV VCR EURO-AV socket (input/output) for video recorder or additional PAL decoder.
- ④⑨ 10-pin connector strip:
- | Pin | Designation | Connection |
|-----|--|--|
| 1 | 0/12 V/0.1 A | Switching voltage output for LNC switching, relay, etc. |
| 2 | AGC | Field strength measuring output for precise aerial adjustment. |
| 3 | GND | Earth (ground) |
| 4 | +5 V/0.2 A | Output for motor-driven polarizer, actuator. |
| 5 |  POL. | Control pulse voltage (output) to motor-driven polarizer. |
| 6 | MAGN. | Current output for magnetic polarizer, ± 70 mA/max. ± 12 V |
| 7 | GND | Earth (ground) |
| 8 | M2 | Supply voltage for rotary motor, 36 V (positive on east run). |
| 9 | M1 | Supply voltage for rotary motor, 36 V. |
| 10 |  | Control pulse voltage (input from rotary motor). |
- ⑤⑩ DC OUT 15 V / 0,8 A 15 V / 0.8 A output for connecting external units (e.g., decoder).
- ⑤① 220 - 240 V ~ 50 - 60 Hz Connection for plug-in mains cable. Pull mains plug to disconnect the unit from the mains!

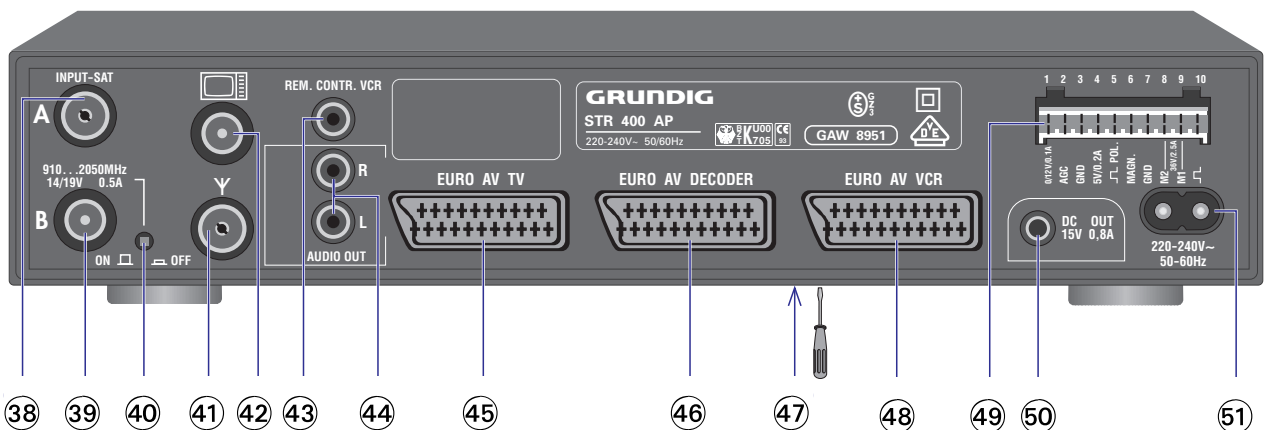



Important Information

General

For the description of the unit's functions, it is assumed that the aerial has correctly been installed and that the receiver has correctly been connected.

Button Lock

Attention!

Except of the  and  buttons, all buttons are locked to prevent inadvertent operation. To clear the lock, press one of the locked buttons for more than 3 seconds.

When switching the receiver off by means of the POWER  switch, or with the remote control handset to standby, the lock is activated again.

Connecting the SAT Receiver to the Television

Best picture quality is obtained when the receiver and the television are connected by means of a EURO-AV cable (see connection example). If you possess a television without EURO-AV socket, make the connection via the built-in modulator with a coaxial cable. The modulator is preset to channel 36.

If this channel should already be occupied by your video recorder or a terrestrial station, it is possible to change the channel (see paragraphe "Modulat. – Adjusting the Modulator Channel"). You have the choice between channel 25 and channel 60. The television must also be tuned to this channel.





16:9 Switching

If a switching voltage (6 V) for the 16:9 picture format is present on the EURO-AV **DECODER** or **VCR** socket, this will be evaluated and passed to the EURO-AV **TV** socket. Correspondingly equipped TV sets then are automatically switched to the 16:9 format.

Selecting the Aerial Input



The receiver is provided with two aerial inputs. Preprogramming in the factory has been made for the standard solution, comprising one LNC with frequency switching by means of a 14/18 V supply voltage, and polarization switching by means of a magnetic or mechanic polarizer.

If you wish to implement different solutions, such as, for example, two-cable distribution in the first IF level (separate H/V), several aerials, or multi-feed mode, it is necessary to activate the second aerial input with respect to the programme position.

Press the  button twice, then use the  buttons to select input A  or B . The display indicates, for example:



Store the setting with the  MEMORY button. The display indicates again the current programme position. See also section "Adapting the Polarizer, Installation Menu".

If there should be interferences visible in the form of spikes (short black or white lines), these can be eliminated by optimizing the input frequency setting. For this, press the  P/F button and adjust the value giving the best picture on the TV screen by means of the  buttons. Store the corrected value in memory by pressing the  MEMORY button.

Hint

The receiver is already preprogrammed to all current programmes from a number of satellites. See the yellow pages: "Station Table of the Satellite Stations".

If you wish a different programme order, it is very easy to change the existing order.

For detailed information, see the corresponding explanation (SORT function in the chapter "The Mode Menu").

Basic Adjustment of the Polarmount Aerial

General

A polarmount aerial is constructed so that the imaginary line, on which the satellites are orbiting at a distance of 36000 km above the equator, can be followed by a single control function of the motor.

There are a number of different motor types and motor fixings.

The action radius of the aerial (max. deflection to the east and the west) can be restricted by limit switches inside the motor, or by mechanical end stops. This is especially necessary to protect the aerial from running against obstructions (walls, trees, etc).

In addition, the receiver is provided with electronic limit switches (similar to tab stops on a typewriter) for restricting the action radius of the aerial.

Attention!

It is not allowed to use these limits to protect the aerial from running against obstructions. If a test run should be necessary for adjustments at a later date, these limits would be overridden and the aerial thus could be damaged. The following illustration shows the relations.

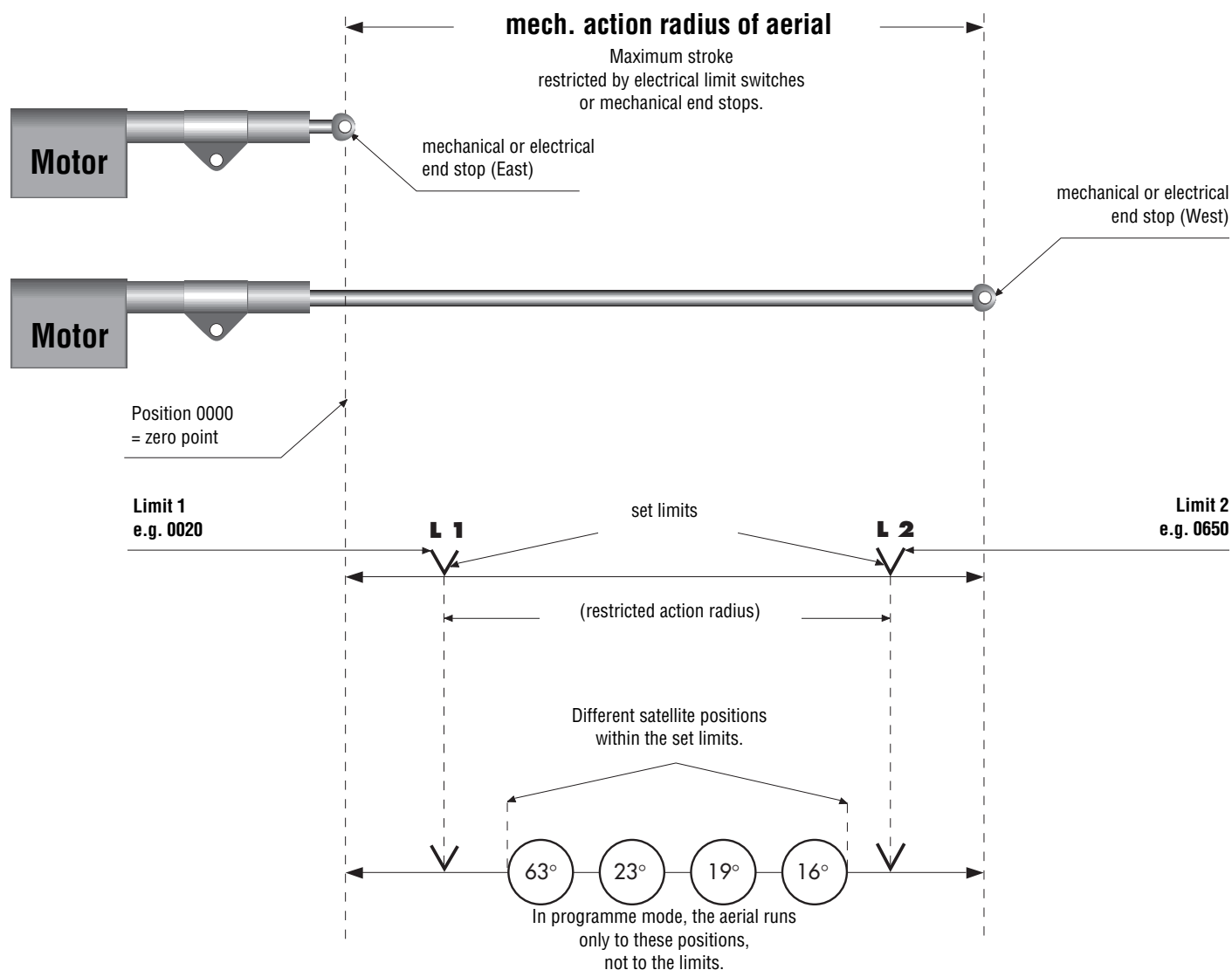

Basic Adjustment of the Polarmount Aerial

Setting the Zero Position and Limits

Driving the exactly mounted aerial to the east end stop

It is absolutely necessary to execute this step.

Before setting the limits L1 (East) and L2 (West), it is absolutely necessary that the aerial has been driven to its mechanical east end stop for setting the internal counter to zero.

The aerial must be mounted in such a way that no obstructions (trees, walls, etc.) can hinder its travel to its east end position.

Follow these steps:

Switch the unit on.

Press the  button 3 times.

The display indicates, for example:



199 L1 414 STEREO SIGNAL



Press the  button to drive the aerial to the east.

Attention:

If the aerial should run in opposite direction, it is necessary to exchange the connections M1 and M2 on the terminal strip  of the receiver.

Press and hold down the  button until the east end stop is reached, giving the following indication: "EAST END". This represents the zero position of the internal counter and is the reference point for all satellite positions programmed at a later date.

Setting limits

When searching new satellites at a later date with the help of the manual aerial positioning function, it may happen that the limit switches or mechanical end stops (crash) are often run to. To avoid this, electronic limits can be set at a short distance in front of these end positions. For this, press the  button to let run the aerial approx. 20 impulses to the west, then store the setting by pressing the  MEMORY button.

The display indicates:



199 LIMIT 1 STEREO SIGNAL

Press the  button once again.

The display indicates:





199 L2 20 STEREO SIGNAL

Press and hold down the  button until the aerial has reached its west end stop.

The display indicates:



199 WEST END STEREO SIGNAL

Press the  button to let run the aerial approx. 20 impulses to the east, then store the setting with the  MEMORY button.

The display indicates:



199 LIMIT 2 STEREO SIGNAL

You can connect to the receiver motors delivering max. 7999 impulses between the east and west end stops. The impulses can be generated by Reed contacts, Hall sensors, or opto couplers.

Adapting the Receiver to Different Aerial Systems with Different Feed-in Systems (LNC's).

Today, there exist a variety of very different LNC types with different local oscillators and control commands for frequency and polarization switching.

It is necessary to adapt the receiver to the used feed-in system.

For rotary systems, LNC's with switchable frequency range are used. Polarization switching can be effected by means of a **14/18V*** supply voltage or magnetic/motor-driven polarizers. You can also use feed-in systems (reception systems) with 2 separate LNC's for different frequency ranges (including a wave-guide separating filter).

Your receiver is provided with 2 aerial inputs (Input A, Input B) which make it possible to connect an additional aerial (for example, permanently pointing at the Astra satellite, which then is permanently available).

The following illustrations show several application possibilities.

The receiver offers a choice of three system configurations. These system configurations enable a large number of connection variants and make it very easy to adapt the receiver to the aerial system used.

* 14/18 V LNC individually adaptable by ± 2 V (see  in section "Receiver Buttons and Connections / Rear of unit).

Basic Adjustment of the Polarmount Aerial

System 1

Frequency switching with
14/18 V, e.g., Grundig package STP 400/STP 300 A,
or 0/12 V, e.g., Grundig package STP 300,
or with 0/22 kHz, e.g., future Astra solution.

Polarization switching:
exclusively with motor-driven
or magnetic polarizer.

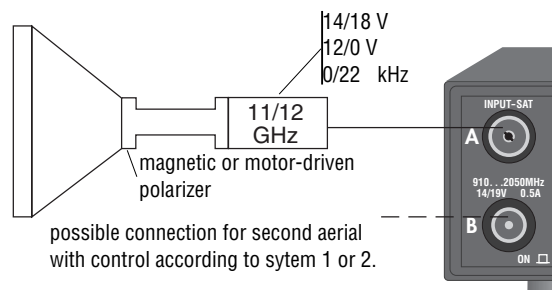

Frequency range	Polarization	LNC power	Preprogrammed skew value	Preprogrammed switching voltage value	Switching frequency
11 GHz	V1 (vertical 1)	14 V	approx. +30 mA	12 V	0 kHz
11 GHz	H1 (horizontal 1)	14 V	approx. -30 mA	12 V	0 kHz
12 GHz	V2	18 V	approx. +18 mA	0 V	22 kHz
12 GHz	H2	18 V	approx. -18 mA	0 V	22 kHz

System 2

Frequency switching with
0/12 V or
0/22 kHz

Polarization switching with
14/18 V or
magnetic/motor-driven polarizer.

The switching frequency 0/22 kHz can also be used for driving a coaxial relay.

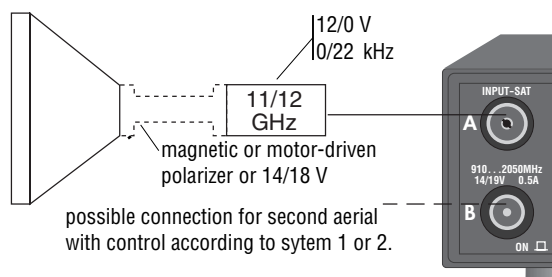

Frequency range	Polarization	LNC power	Preprogrammed skew value	Preprogrammed switching voltage value	Switching frequency
11 GHz	V1 (vertikal 1)	14 V	approx. +30 mA	12 V	0 kHz
11 GHz	H1 (horizontal 1)	18 V	approx. -30 mA	12 V	0 kHz
12 GHz	V2	14 V	approx. +18 mA	0 V	22 kHz
12 GHz	H2	18 V	approx. -18 mA	0 V	22 kHz

System 3

Frequency switching with input A/B for systems with 2 LNC's (A: 11 GHz, B: 12 GHz) and waveguide filter.

Polarization switching with
14/18 V or
motor-driven/magnetic polarizer.

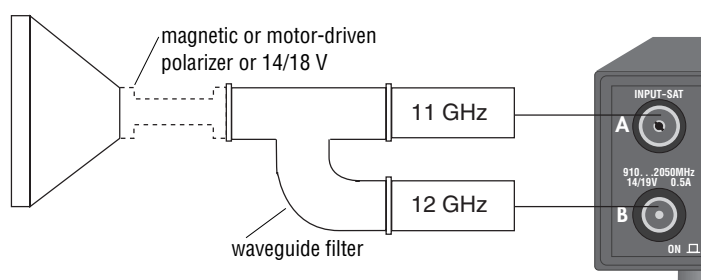

Frequency range	Polarization	LNC power	Preprogrammed skew value	Preprogrammed switching voltage value	Switching frequency
11 GHz	V1 (vertikal 1)	14 V	approx. +30 mA	12 V	0 kHz
11 GHz	H1 (horizontal 1)	18 V	approx. -30 mA	12 V	0 kHz
12 GHz	V2	14 V	approx. +18 mA	0 V	22 kHz
12 GHz	H2	18 V	approx. -18 mA	0 V	22 kHz

It is possible to allocate the inputs A/B to sytem 1 or system 2 as desired (make the corresponding adjustments in the installation menu). For system 3, allocation of the inputs A and B is predetermined.

The LNC power 14/18 V and the switching voltage 0/22 kHz are transferred via the coaxial cable which is connected to input A or B. The 0/12 V switching voltage and the control signals for a magnetic/motor-driven polarizer are available at the 10-pole connector strip ④9 and must separately be wired.

Basic Adjustment of the Polarmount Aerial

STR 400 AP installation mode (LNC frequency entry)

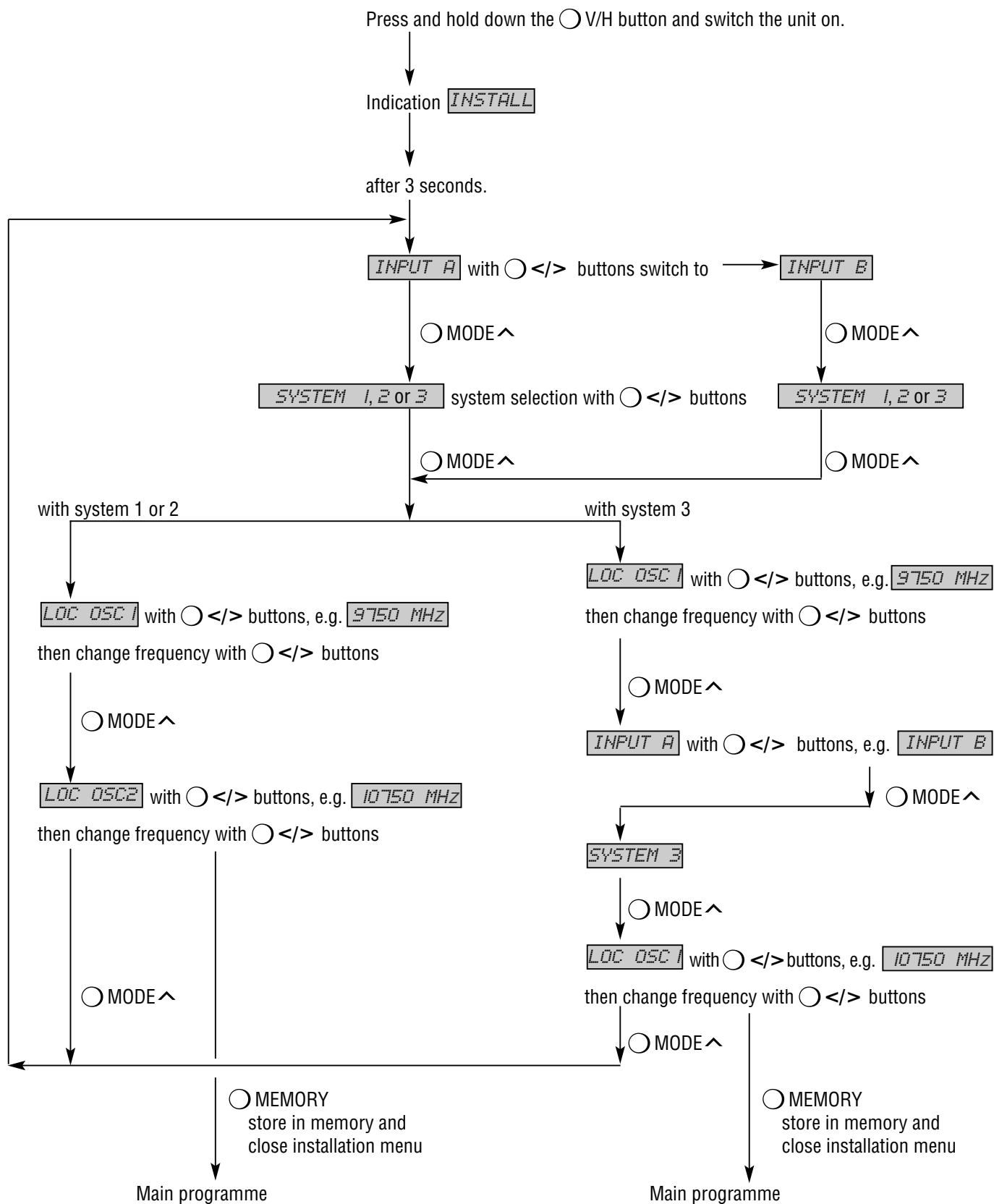

With the P/F button, you can abort the installation menu from any menu option. In this case, the changed settings are not stored in

Basic Adjustment of the Polarmount Aerial

Installation Menu

With the unit switched off, press and hold down the \bigcirc V/H button and switch the unit on. The display indicates "INSTALL".

The preceding diagram shows an overview of the installation menu. After approx. 3 seconds, the display indication changes to "INPUT A". With the \bigcirc </> buttons, you can switch to "INPUT B". Select the desired aerial input, then press the \bigcirc MODE^ button.

You pass to the next menu item where the frequency of the local oscillator 1 (lower LNC frequency range) will be asked. The display indicates "LOC OSC 1". Pressing one of the \bigcirc </> buttons switches to the frequency indication. Select the desired value with the \bigcirc </> buttons (hold down the corresponding button to let scroll the values at high speed).

With **system 1 or 2**, pressing the \bigcirc MODE^ button switches to the 2nd oscillator frequency (upper LNC frequency range). The display indicates "LOC OSC 2". Enter the frequency as described above.

Next, you can...

- if necessary, proceed by selecting INPUT B with the \bigcirc MODE^ button.
- store in memory the settings made by pressing the \bigcirc MEMORY button (this will close the installation menu).
- abort the installation menu by pressing the \bigcirc P/F button. The old settings are restored and the installation menu is closed. Aborting the menu with the \bigcirc P/F button is possible from any menu item.

With **system 3**, the oscillator frequencies for both inputs must be entered. The inputs A and B are permanently allocated:

- Input A: Frequency band 11 GHz.
Polarizations V1, H1.
- Input B: Frequency band 12 GHz.
Polarizations V2, H2.

In this case, it is not possible to use the \bigcirc V/H button to directly switch during normal operation between the inputs A and B, as explained in chapter " \bigcirc V/H - Selecting Vertical/Horizontal Polarization and Input A/B". It is possible to freely select between the polarizations V1, H1 (input A) and V2, H2 (input B). Switching between the inputs then is performed automatically.

Adapting the Polarizer

If you should have selected a system with magnetic or motor-driven polarizer, this must also be preadjusted, as there are many different types available.

How to proceed:

At first, the aerial must be positioned at the satellite. We recommend the powerful Astra satellite. This will be explained in the following example.

Select the programme position number 1 (Astra satellite, 19° East, ARD) on the receiver. This programme position is pre-programmed with horizontal polarization H1. The default impressed current for the polarizer is to be optimized by performing the following steps:

Press the \bigcirc ⊗ button to switch the receiver into the manual aerial positioning mode. Press the \bigcirc < button to run to limit 1, then press the \bigcirc > button to search the Astra 19° East satellite. If the picture of ARD appears on the picture screen, the correct satellite has been found.

If you should not be able to find this programme, change the polarity of the connections of the magnetic polarizer on the 10-pole connector (MAGN:/GND) and repeat the above steps. Press the \bigcirc ⊗ button once again to display the signal level. Adjust the maximum level by means of the \bigcirc < or \bigcirc > button. Press the \bigcirc V/H button and then the \bigcirc MODE^ button.

The display indicates, for example:



The polarizer current can be adjusted by pressing the \bigcirc </> button. The correct adjustment is situated between the black and white spikes. To avoid multiple polarization rotations, the smallest required value should be adjusted.

Press the \bigcirc MODE^ button once again.

The display indicates:

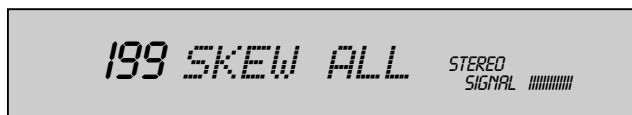

Store the setting with the \bigcirc Memory button. All programme positions preprogrammed with H1 now will successively be set to this optimum value.

Repeat the same steps for stations with vertical polarization V1.

For this, select programme position 3 (RTL in Germany).

Press the \bigcirc V/H and then the \bigcirc MODE^ button.

The display indicates, for example:

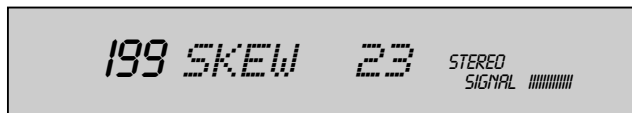

Basic Adjustment of the Polarmount Aerial

Adjust the optimum skew value as explained above, press the \odot MODE \wedge button once again, and store the setting with the \odot MEMORY button.

From this point on, all programme positions preset with vertical polarization are automatically set to this optimum value.

As a number of satellites are not fixed exactly according to the polarmount method, it may happen that certain programmes need an individual correction. To do this, use the SKEW menu option and not the SKEW ALL menu option.

To adjust the optimum skew value for the upper frequency range (12.5 GHz), it is necessary to search a further satellite (e.g., Kopernikus) and to adjust a station with V2 respectively H2 following the already explained adjustment method.

The skew values V2 and H2 have no influence on the values of H1 and V1. The SKEW ALL function can be used again and greatly facilitates programming.

Storing the Satellite Position in Memory

After having made the above explained adjustments, the position of the Astra satellite should be stored in memory. For this, press the \odot \otimes button.

The display indicates, for example:

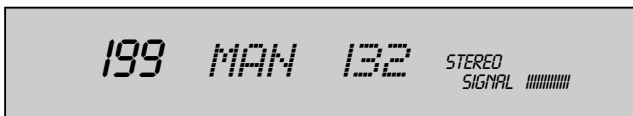

Then, press the \odot MODE \wedge or \odot MODE \vee button.

The display indicates, for example:

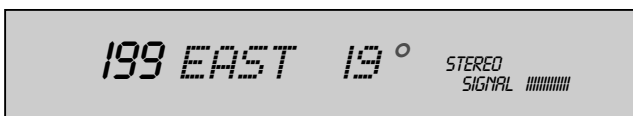

Press the \odot MEMORY button to conclude storing.

All programmes of the Astra satellite with the pulse number indicated in the MAN menu option (manual aerial adjustment) are now stored with the position 19° East.

Following this method, you can store all satellites from east to west:

Select a programme position for the satellite concerned, search the satellite using the MAN menu option, and optimize the signal level in the LEV menu option (to get the signal strength indication, press the \odot \otimes button). Then call up the satellite position menu function (press the \odot MODE \wedge or \odot MODE \vee button) and store the setting by pressing the \odot MEMORY button.

If the motor drive should inadvertently start running when calling up the programme position of a satellite which is not yet stored in memory, motor run can be stopped by pressing

Manual motor control with the remote control

After pressing the \odot F (16) button, you have 8 seconds for manually controlling the motor with the \odot \leftarrow \odot \rightarrow buttons. Pressing the \square OK button stores the new aerial position in memory.

The display indicates, for example:



Neutral adjustment

It is possible to connect in addition to the rotary aerial a fixed aerial to your receiver. For example, the rotary system to input A and an aerial which is permanently directed at the Astra satellite to input B (see chapter "Connection Examples").

The position of the rotary system should not change when switching to a programme position used with the fixed aerial. Enter "0°" as position for the satellite whose programmes you wish to receive by means of the fixed aerial. The display then indicates "--" instead of a value for the satellite position. The rotary system then will keep its orientation (position).

Adjustment Run

One of the outstanding features of your receiver is the precise aerial run to the preset satellite positions.

If the receiver is inadvertently switched off during an aerial run, the impulses from the idling aerial motor are no longer counted, resulting in an erroneous positioning for all satellites.

By means of an adjustment run which is automatically started when switching the receiver on again, the aerial is first driven to its east end stop for correcting the bad positioning, then the aerial is exactly positioned to the previously selected satellite.

An adjustment run might also be necessary for other reasons, for example, if a position offset is caused by strong and lasting external impulses.

To start the adjustment run, keep pressed the \odot \otimes button while switching on the unit. Automatic correction of the position is effected as described above.

It is possible to abort an adjustment run by pressing the \odot P/F button.

Buttons and their Functions on the Receiver

General

As already stated, the receiver has been preprogrammed at the factory for the main programmes from the most important satellites.

If you wish a different programme order or intend to correct adjustments, this can easily be done by means of the buttons on the front of the receiver and, in certain cases, with the buttons on the remote control handset. However, this should only be done after having carried out the basic adjustment of the polarmount aerial.

Attention!

The buttons on the front of the receiver, except the \odot </> and \odot RADIO buttons, are electronically locked to prevent that the receiver programming be changed by inadvertent operation of the buttons (for example, when wiping off dust).

To clear the electronic lock, press on any of the locked buttons for more than 3 seconds. When switching the unit off or to standby, the electronic lock is activated again.

Generally applies:

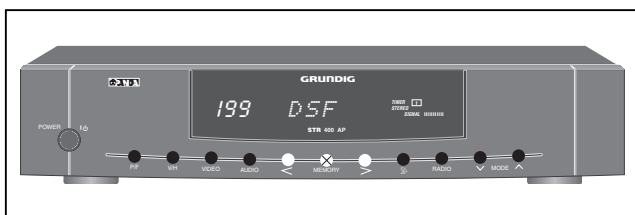

- Certain functions can be called up by pressing these buttons once or several times.
- \odot Preset functions can be modified with these buttons.
- \otimes Settings and corrections made are stored in memory by pressing the \odot MEMORY button.

When switching the receiver on with the power switch Ⓢ , it switches automatically to the last selected programme position (Last Station Memory).

The desired programme positions are selected by means of the \odot </> buttons on the receiver or the programme select buttons $\triangle P+$ $\nabla P-$ or numeric buttons on the remote control handset.

The display indicates the number of the selected programme position and the associated station name. If the new station belongs to a different satellite, the aerial will be positioned to this satellite and the new satellite position is briefly indicated in the display.

To switch the receiver on from standby, press one of the programme select buttons $\triangle P+$ $\nabla P-$ or of the numeric buttons on the remote control handset, or of the \odot </> buttons on the receiver. In this case too, the last selected programme position will be selected again (Last Station Memory).

\odot P/F – Selecting Programme/Frequency

Ku-Band reception (10700 to 13000 MHz)

Use the \odot P/F button to switch between programme position mode and frequency entry mode.

The display indicates the programme positions 1 to 199 or, in frequency entry mode, 10700 to 13000 MHz. Real reception, however, is only possible in the frequency range for which the used LNC has been designed. In this mode, direct frequency entry with the numeric buttons of the remote control handset is possible.

Pressing and holding down the \odot > button will change the frequency in steps of 10 MHz in upward direction, and holding down the \odot < button in steps of 3 MHz in downward direction.

This allows you to scan the entire frequency range at high speed in forward direction, and at lower speed in reverse direction.

With single step tuning, the frequency is changed in steps of 0.5 MHz, which corresponds to the finetuning function.

Particularities when receiving S- and C-band satellites (2.5 ... 4 GHz)

For receiving the 2.5 ... 4 GHz frequency bands, special aerials and LNC's are necessary.

For receiving stations on these frequency bands with your unit, you must observe the following:

The value 10000 MHz must generally be entered in the installation menu as local oscillator frequency for the LNC, not the actual value of the LNC.

When adjusting the frequency for the programme position concerned (\odot P/F button), do not enter the transmission frequency of the satellite, but the output frequency of the LNC (first intermediate frequency = IF 1).

You can calculate the IF 1 by subtracting the transmission frequency of the satellite from the actual local oscillator frequency.

$$\begin{aligned} \text{E.g.} \quad & \text{Local oscillator frequency:} && 5100 \text{ MHz} \\ & - \text{Satellite transmission frequency:} && - 3900 \text{ MHz} \\ & = \text{Result (IF 1):} && = 1200 \text{ MHz} \end{aligned}$$

To enter this value, first press the "0" button. The display indicates:

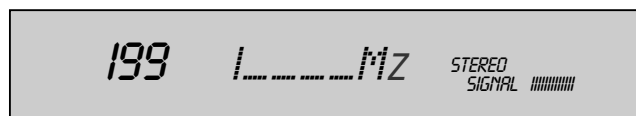

In this case (S- and C-band reception), the first figure "1" has no physical meaning. Then, enter the value for the IF 1. For a three-digit value, an additional "0" must be entered at the first position.

Buttons and their Functions on the Receiver

Examples:

IF 1:	Entry:	Indication:
1200 MHz	01200	11200 Mz
950 MHz	00950	10950 Mz

Please also observe setting of the video deviation -1, -2 or -3 (see paragraphe "○ Video – Adjusting the Video Deviation").

○ V/H – Selecting Vertical/Horizontal Polarization and Input A/B

Press the ○ V/H button to indicate the current polarization in the display, e.g., (H1 18 V)



With the ○ </> buttons, you can select between V1, H1, V2, and H2.

Allocation of the respective LNC voltage depends on the selected LNC system (see paragraphe "Setting Zero Position and Limits").

For LNC's with magnetic polarizer, the optimum skew value must be adjusted after having selected the polarization (see also paragraphe "SKEW ALL – Transferring the Skew Value").

Press the ○ V/H button once again to indicate on the display the input which is to be selected with the ○ </> buttons ("INPUT A" or "INPUT B"). See also the sections "Adapting the Polarizer, Installation Menu", and "Selecting the Aerial Input".

○ VIDEO – Adjusting the Video Deviation

The frequency-modulated satellite signals are transmitted with different deviations. To obtain a good picture, the receiver must be adjusted correspondingly.

Press the ○ VIDEO button to indicate on the display the video deviation and video polarity, e.g., (DEV. 3).

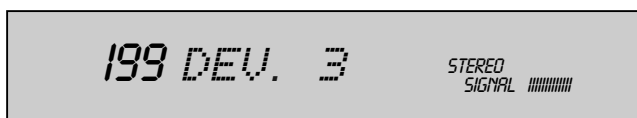

The video deviation is selected with the ○ </> buttons:

DEV. 1 = 25 MHz,	DEV. -1 = 25 MHz,
DEV. 2 = 22.5 MHz,	DEV. -2 = 22.5 MHz,
DEV. 3 = 16 MHz,	DEV. -3 = 16 MHz.

For C-band and S-band reception with 4- resp. 2.5GHz LNC's, the video signal must be inverted by selecting the setting DEV. -1 ... DEV. -3.

○ AUDIO – Mono/Stereo and Sound Carrier Switching

Press the ○ AUDIO button to indicate the current audio mode in the display, for example:



By repeatedly pressing the ○ AUDIO button, you can select between:

MONO < > = Main carrier, Mono wide,
MONO > < = Subcarrier, Mono Panda Wegener,
STEREO = Panda carrier*, Stereo.

On STEREO, the indication "STEREO" appears in addition on the display ② of the receiver. Press the ○ < or ○ > button to indicate the actual value of the set frequency, for example:

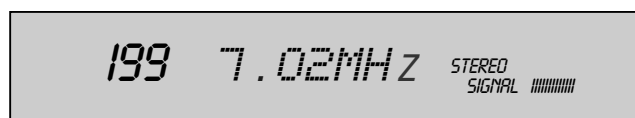

You can adjust the frequency between 5.00 MHz and 9.99 MHz in steps of 10 k Hz.

Pressing and holding down the ○ < or ○ > button will scan the frequencies at high speed.

Direct frequency entry is possible with the numeric buttons of the remote control handset. Tuning will be effected only after having entered the third frequency digit.

○ </> – Down/Up Setting Buttons

When in programme mode, use the ○ </> buttons to select the next programme position down or up.

In the other modes, the ○ </> buttons are used for changing the entered data.

When holding down the corresponding button, the programme positions or data values are selected and displayed at high speed.

When in standby, pressing the ○ </> buttons will switch to the last selected SAT programme position (Last Station Memory).

○ MEMORY – Storing Data in Memory

Pressing the ○ MEMORY button stores all data in memory.

* Panda/Wegener Communications Inc.. Award for highest tone quality.

Buttons and their Functions on the Receiver

○ – Aerial positioning / designating the satellite position and station

Aerial positioning

Pressing the ○  button calls up a submenu with functions for adjusting the aerial and naming the stations and satellites. The diagram below provides you with an overview.

These functions have already been explained in the chapter "Basic Adjustment of the Polarmount Aerial".

Press the ○  button (for the first time).

The display indicates, for example:

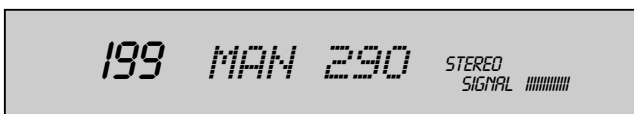

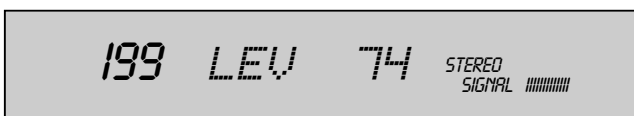

In this menu option, it is possible to manually drive the aerial between two set limits L1 (East) and L2 (West) by pressing the ○ < and ○ > button, respectively.

Press the ○  button a second time. The display indicates, for example:



When in this menu option, the numeric value of the reception level is indicated. The resolution of this indication is much higher than the bar display following the "SIGNAL" lettering (at the right in the display). With the help of the level indication, it is possible to adjust the aerial by means of the ○ </> buttons to optimum reception fieldstrength. (In the vicinity of the maximum value, press the buttons only briefly).

Press the ○  button once again. The display indicates "L / ...". In this menu option, you can set the east limit with the ○ </> buttons. When the east end stop is reached, the display will indicate "EAST END".

Press the ○  button once again. The display indicates "L2 ...". In this menu option, you can set the west limit with the ○ </> buttons. When the west end stop is reached, the display will indicate "WEST END".

Designating the satellite position and station



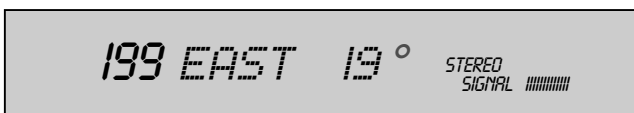

Through pressing one of the ○ MODE ^ and ○ MODE v buttons when you are in the aerial menu (○ ), you can designate the satellite position: in degrees of EAST or WEST direction. The display indicates, for example:



You can allocate a value between 99° East and 99° West by means of the ○ < or ○ > button. In this way, you can allocate the satellite position the number of degrees at which the satellite stands in the orbit (see also section "Storing the satellite position").

This allocation has already been done at the factory for the preprogrammed satellites. Prior to storing a position in memory, the aerial must be directed exactly at the corresponding satellite (as described further up).

The degree number of the satellite position is allocated the actual pulse number of the motor. This makes sure that the aerial is automatically driven into the correct position (pulse number of the aerial motor) when selecting a programme position.

If you press twice on one of the ○ MODE ^ or ○ MODE v buttons when in the MAN (manual aerial adjustment) or LEV menu option, you can change or allocate a new name with the help of the remote control handset. You can change the flashing character on the display with the cursor buttons   on the remote control handset. Use the cursor buttons   to displace the flashing entry position.

Now it is possible to:

Save the current setting with the ○ MEMORY button on the receiver. You return to the programme mode.



Save the current setting with the  button on the remote control handset. You pass automatically to the next programme position the station designation of which now can also be changed.

Quit the menu by pressing the ○ P/F button on the receiver. You return to the programme mode without saving the changed station designation.

Example:

You have selected programme position 184 and wish to change the station name. For this, press one after the other the buttons ○  ○ MODE ^ ○ MODE v. The display indicates:



The letter "A" of "ARD" is flashing (for stations without name, "■" will appear). You can change this character with the cursor buttons   (character sequence: A, B, C, ... X, Y, Z, blank, 0, 1, ... 8, 9, A, B, C ...). When pressing , the second place "R" will flash and can be changed in the same way. After having entered the desired name, continue as described above.

Buttons and their Functions on the Receiver

○ RADIO – Selecting Radio Mode

Pressing the ○ RADIO button toggles between SAT/TV and radio mode. The unit automatically switches to the last selected programme position (Last Station Memory).

When in radio mode, the picture screen remains dark. You can correct set values with the buttons on the receiver. The picture screen shows the current TV picture.

The radio mode is indicated by an additional "R" following the station name.

To benefit from the optimum sound quality, you should connect the L and R phono (Cinch) sockets of the receiver via a phono (Cinch) cable to your hifi system. In this case, the TV receiver can remain switched off.

Overview diagram of the aerial adjustment submenu



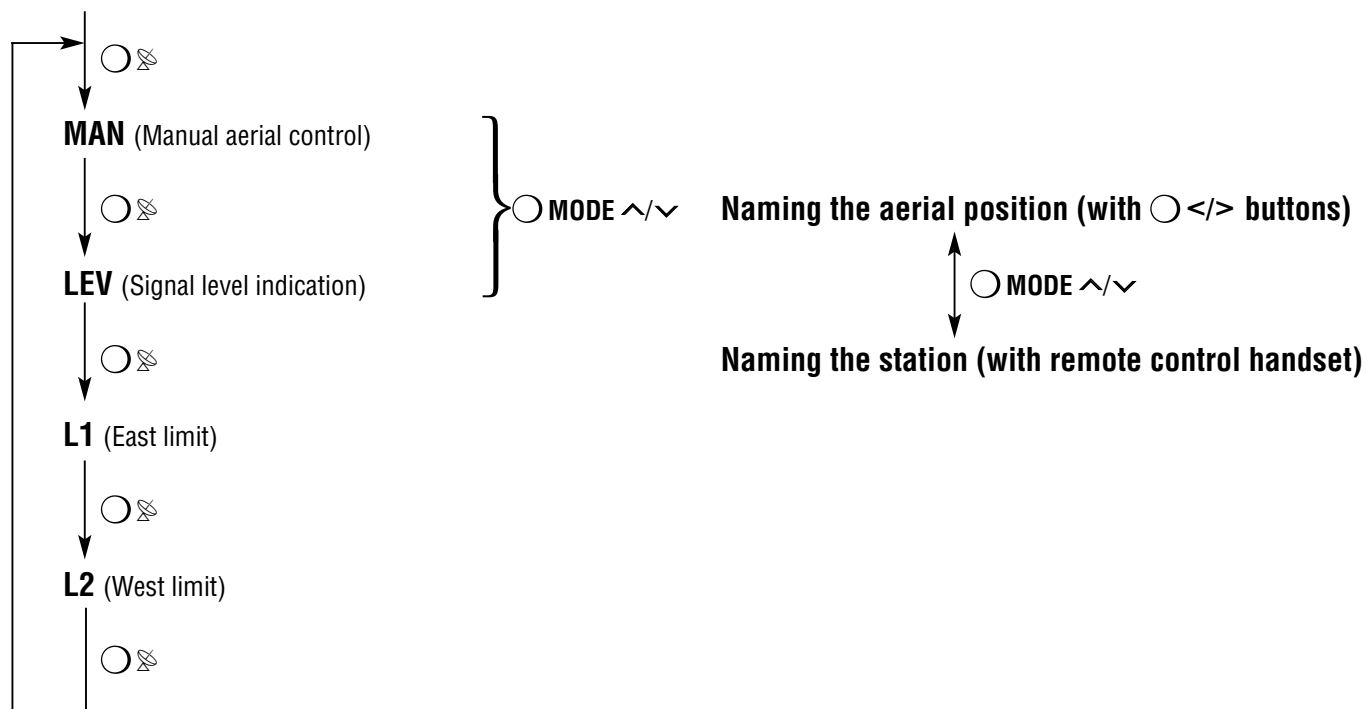











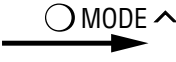

Button for calling up the aerial adjustment functions. To access the submenu for naming the aerial position and stations, press the ○ MODE ^/∨ buttons.

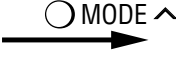

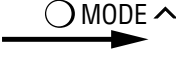

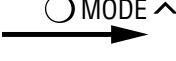

Press the ○ P/F button to return to programme position.

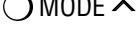
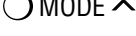
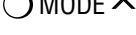
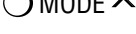
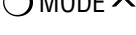
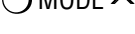







The MODE Menu



Overview

Normal case (e.g. programme mode)			COPY (copy programme)
			SORT (exchange programme)
			0 VOLT/12 VOLT (switching voltage)
 V/H (e.g. "H I B V")			SKEW: -99 ... 128 (polarizer adjustment)
			SKEW ALL (transfer skew value)
 P/F (e.g. "1494 MHz")			WIDE/NARROW (IF bandwidth)
 VIDEO (e.g. "DEV I")			DECODER: AUTOMAT./ON
			VID ONLY/VID & AUD (decoder selection)
			NORM 1/2/3
 AUDIO (only with "MONO < >")			DEEMPH.: 50 µs/J 17 (only for mono wide)
			MODULAT.: CH 25 ... CH 60 (modulator channel)
			ATS (automatic station search)
			TIME/DATE (summer/winter time)
			CODE (child lock)
			DISPLAY: MINIMUM ... MAXIMUM (displ. brightness)
			ACTIVE/INACTIVE (programme position)
			COPY (see above)

A detailed explanation of the menu functions of the "Mode" menu is given in the following sections. The menu has a loop structure (the menu options COPY at the top and the bottom of the overview are identical).

Normally, when calling up the "Mode" menu, you will start with the COPY menu option. Pressing the  MODE  button brings you from one menu option to the next. Pressing the  MODE  button selects the menu options in reverse order.

If you press one of the buttons , ,  or , then call up the "Mode" menu with the  MODE  button, you arrive directly at the menu option which is of great importance for the corresponding function (e.g., pressing first , then , calls up the DECODER menu option).

If one menu option comprises a number of possible settings (e.g. 0 Volt/12 Volt, -99 ... 128), you can make your choice with the   buttons.

The MODE Menu

Use the \bigcirc MODE \wedge/\vee buttons to select the individual setting functions. Changing the settings in the respective mode then is carried out with the \bigcirc \langle/ \rangle buttons or with the numeric buttons on the remote control handset.

Repeated pressures on the \bigcirc MODE \wedge/\vee buttons will bring you to the menu options (functions) of the "Mode" menu. These menu options are explained in the following.

COPY

With this menu function, you can copy all parameters belonging to one programme position into another programme position.

The data of the original programme position (source) is retained, the data of the "target" programme position is overwritten.

The display indicates, for example:

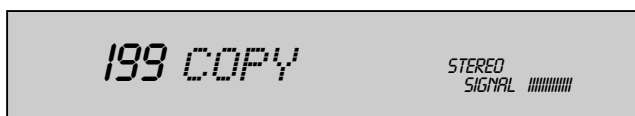

Select the programme position into which you wish to copy the data with the \bigcirc \langle/ \rangle buttons or with the numeric buttons on the remote control handset. The programme position number flashes.

Now, press the \bigcirc MEMORY button and copying is executed.

COPY for radio programmes

The copy function is especially useful for storing new radio programmes (which are not yet preprogrammed) which are broadcast on a sound subcarrier along with TV programmes.

To do this, first copy the corresponding TV programme position into a free RADIO programme position.

Next, press the \bigcirc MODE \wedge button; the display indicates "COPY".

Next, press the \bigcirc RADIO button and select a free programme position with the \bigcirc \langle/ \rangle buttons or with the numeric or programme select buttons \triangle_{P+} ∇_{P-} on the remote control handset. Press the \bigcirc MEMORY button to store this setting in memory.

Then, use the \bigcirc AUDIO button to select MONO $> <$ or STEREO and enter the desired sound carrier frequency with the \bigcirc \langle/ \rangle buttons or the numeric buttons on the remote control handset.

Conclude by storing the setting with the \bigcirc MEMORY button.

For stereo reception, only the lower sound carrier for the left channel is entered; the right channel is automatically stored in memory.

SORT

"SORT" is indicated on the display. With this function, the programme positions are exchanged.

Select the programme position you wish to exchange by pressing the \bigcirc \langle/ \rangle buttons on the receiver or the numeric or programme select buttons \triangle_{P+} ∇_{P-} on the remote control handset. The programme position number will flash.

Pressing the \bigcirc MEMORY button executes the sort function and the programme positions are exchanged.

By repeatedly applying the "SORT" function, the programme positions can be brought into a new order.

0/12 VOLT – External Switching Voltage

"0 VOLT" or "12 VOLT" is indicated on the display.

With the \bigcirc \langle/ \rangle buttons, it is possible to select a programme-position-related switching voltage of 0 or 12 V. This switching voltage is available at the terminal strip (49) and can be used for a variety of external applications (e.g., control of a coaxial relay, multifeed system).

SKEW – Polarizer Adjustment

"SKEW" (polarizer) is indicated on the display.

With the \bigcirc \langle/ \rangle buttons, it is possible to set a numeric value between -99 and $+128$. This value range corresponds to a constant current between approx. -70 mA and approx. $+90$ mA for a magnetic polarizer.

Determine the optimum value and store it in memory by pressing the \bigcirc MEMORY button (see also section "Adapting the Polarizer").

Along with this voltage, an impulse signal for a motor-driven polarizer is available at the \square POL. output of the 10-pole connector strip. This is adjusted by means of the same commands.

The MODE Menu

SKEW ALL – Transferring the Skew Value

After having adjusted the optimum value for a polarization plane, e.g., horizontal, in the "SKEW" menu option (polarizer adjustment),

press the \bigcirc MODE \wedge button once again.

The display indicates "SKEW ALL".

Store with the \bigcirc MEMORY button.

The optimum skew value set before is automatically transferred into all horizontally preprogrammed programme positions of the same group (H1 or H2).

Next, select a station with vertical polarization, optimize the skew value in the "SKEW" menu option, call up the menu option "SKEW ALL" with the \bigcirc MODE \wedge button, and press the \bigcirc MEMORY button to store in memory. All vertically preprogrammed stations of the same group (V1 or V2) are automatically optimized.

WIDE/NARROW – IF Bandwidth

The display indicates "WIDE" or "NARROW".

If the aerial signals are very weak, or to suppress possible interference signals, it is recommended to switch the IF bandwidth to "NARROW" by pressing the \bigcirc \langle / \rangle buttons.

This will improve the picture quality.

Then, press the \bigcirc P/F button once again, use the \bigcirc \langle / \rangle buttons to correct the frequency in single steps to get a minimum number of spikes, and store with the \bigcirc MEMORY button.

DECODER

"DECODER" is indicated in the display.

It is possible to switch the decoder into the signal path and to select between "AUTOMAT." and "ON" by means of the \bigcirc \langle / \rangle buttons.

Select "AUTOMAT." for decoders which deliver a switching voltage when a decoded (scrambled) programme is received, for example, Premiere.

Select "ON" for decoders which do not evaluate the switching voltage.

The receiver is preset to "AUTOMAT.".

VID & AUD – Decoder Selection

With the \bigcirc \langle / \rangle buttons, it is possible to select whether picture and sound signals (indication: "VID&AUD") or only video signals (indication: "VID ONLY") are to be passed through the decoder for decoding ("descrambling").

NORM – Norm 1, 2 or 3

In this menu option, you can select the norm in which the signals are to be available at the decoder socket.

With the \bigcirc \langle / \rangle buttons, it is possible to switch the signal at pin 19 of the decoder socket between

NORM 1 = clamped video signal (e.g., 2nd VCR, Première),

NORM 2 = baseband with PAL deemphasis (e.g., Video Crypt), and

NORM 3 = baseband with linear deemphasis (e.g., MAC).

The selected norm (1, 2 or 3) is indicated in the display.

DEEMPH. – with MONO $\langle \rangle$

This menu option is only called up if you have selected the sound mode "Main carrier Mono $\langle \rangle$ " in audio mode. If so, you can switch the audio deemphasis between J17 and 50 μ sec by means of the \bigcirc \langle / \rangle buttons. This selects the signal filter characteristic for the sound signal.

For "MONO $\langle \rangle$ " and "STEREO", this menu option is not required and therefore skipped.

The MODE Menu

MODULAT. – Adjusting the Modulator Channel

The display indicates "MODULAT."

With the \odot </> buttons, it is possible to select an HF channel between CH 25 and CH 60 of the PLL modulator. The factory-presetting is 36 (CH 36).

The TV receiver needs to be connected via the HF output of the SAT receiver if it has no EURO-AV socket.

It is also possible to connect an additional TV receiver (e.g., in the sleeping room) to this socket. In this case, the TV receiver can be controlled via an additional infrared receiver and a 3-pole telephone cable which is connected with the remote control socket of the SAT receiver (see connection example on page 4).

ATS – Automatic Tuning System

It is possible to effect an automatic search for the stations (programmes) of a new satellite and store the desired stations in memory.

To do this, first manually direct the aerial with the help of the aerial menu at the "new" satellite (see chapter "Basic Adjustment of the Polarmount Aerial"). Next, select the ATS menu option and start the automatic search by pressing the \odot > button.

Stations are searched in direction of increasing frequencies. If a station has been found, this is automatically finetuned.

It is possible to store the found station in memory by pressing the \odot MEMORY button, or to restart the search with the \odot > button. After each storage function, the programme position is incremented by one. If the whole frequency range has been run through, use the \odot H/V button to select the other polarity and start the search function again.

Existing station designations will be erased.

The search function is infinite. When the highest frequency (13000 MHz) has been reached, the search is automatically restarted at 10700 MHz. The frequency band which can actually be received depends on the used LNC.

Necessary picture and sound corrections such as, for example, sorting, copying, sound carrier and mono/stereo changes, must be carried out now, not during the ATS search function.

When the search is concluded, it is very easy to determine the desired programme order with the "SORT" menu option.

20:15 – Time and Date

The display indicates the time, for example:

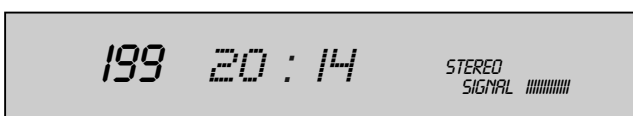

If the clock is running, the colon between the hours and minutes indication is flashing.

With the \odot > button, you can switch between time and date indication.

With the numeric buttons on the remote control handset, it is possible to set (correct) the time and date (summer time/winter time).

After having entered the last digit, time setting is concluded.

Invalid values (e.g. 31.2.) are ignored. To ensure that ulterior Timer functions are correctly started, the clock should precisely be set.

CODE – Child Lock

It is possible to protect your receiver against unauthorized use (child lock).

Enter your 4-digit personal security code, for example, 2537, with the numeric buttons on the remote control handset.

The display indicates:

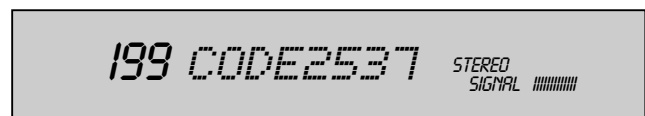

The child lock is activated by pressing the \square OK button.

The display indicates for approx. 3 seconds "SET".

Then, the display automatically indicates the current programme position number.

Now, when switching off the unit, it will be locked.

When switching the unit on again with the power switch or, from standby, with the remote control handset, the display indicates "CODE".

This message prompts you to enter your personal security code. When entering the code, this will be hidden:

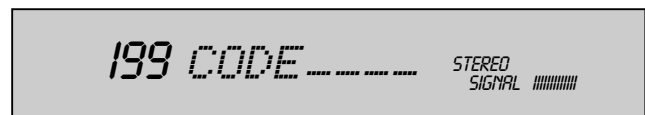

If the correct code number is entered, the receiver will be unlocked and switched to the programme position selected before.

However, the child lock remains active, i.e. the receiver is locked again when switching it off the next time.

The MODE Menu

Clearing the child lock

Call up the "CODE" menu function and enter your personal code number (2537 in the above example). In this case, the entry is visible. Press the **OK** button and the child lock is cleared.

The display indicates for approx. 3 seconds:

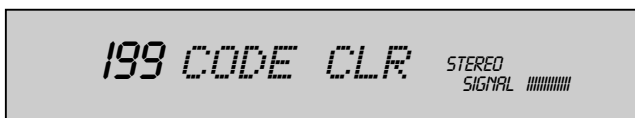

The receiver is unlocked and the security code cleared.

Remember your personal code number!





If you should forget your personal code number, the key  on the last page (cover) will help you. With this combination of button pressures, you will unlock the receiver and clear the code number.

DISPLAY – Display Brightness

You can adjust the display brightness with the  buttons. When the limits of the control range are reached, the display indicates for approx. 3 seconds "MINIMUM" and "MAXIMUM", respectively.

ACTIVE/INACTIVE Programme Position

At the factory, the receiver has been preprogrammed for all satellite stations, including those with coded ("scrambled") programmes.

It is possible to deactivate programme positions with the  buttons. When in programme mode, inactive programme positions will be skipped when they are selected with the   buttons on the remote control handset. Inactive programme positions can be called up by entering their number directly with the numeric buttons or with the  buttons on the receiver.

With this menu option, inactive programme positions can be reactivated in the same way.

Datalink – Data Transmission

Datalink – Data Transmission

All memory data can be transmitted via the VCR socket  from a transmitting to a receiving Sat receiver.

Follow these steps:

Switch off both units and connect them with a phono (Cinch) cable (sockets .

Switch on the receiving unit.

On the transmitting unit, hold down the  button and switch on. Now, the unit sends the programme data to the receiving unit. While transmitting, the display indicates "SEND" (send data). If the receiving unit recognizes the transmitted data, the display of the receiving unit changes the programme number indication to "RECEIVE" (receive data).

Transmission takes approx. 3 minutes. If transmission was successful, the display of both units will indicate "1" for programme position 1.

If an error should occur during transmission, the message "ERROR" appears in the display of the receiving unit. In this case, data transmission must be repeated.

Remote Control Functions

Direct Programme Selection

Use the numeric buttons ①...⑨ to directly select the desired programme (position).

If you enter more than one digit within approx. 3 seconds, you can call up 2- or 3-digit programme positions.

If no second or third entry is made within this time, the entry cursor jumps to the units position.

You can select 199 programme positions for TV and radio each.

Further functions of the numeric buttons are explained in chapter "Buttons on the Remote Control Handset".

Radio/TV Switching

Use the ① or ○_{RADIO} button to switch between TV and radio mode.

In radio mode, the picture screen remains dark and an "R" appears after the station name in the display. When switching, the display indicates for approx. 2 seconds "RADIO" or "TV".

Programme Select Buttons

Step-by-step programme selection is effected with the  buttons. Holding down these buttons automatically selects the programme positions at high speed. Inactive programme positions are skipped.

Buttons

In the Timer menu (see chapter "Timer Menu"), you can select one of the 4 Timer positions with the  buttons.

After pressing the ○_F button, you can control the motor for positioning the aerial by pressing the  buttons.

If you press and hold down the  button, you can set the volume of your TV set with the  buttons.

Standby

With the  button, the receiver is switched to standby. The display indicates "⏻". LNC, switching- and AV voltages are switched off.

When in standby, pressing one of the numeric buttons ①...⑨ switches on the corresponding programme. When using the  buttons, the receiver switches to the last selected TV programme (Last Station Memory).

Button

When using a suited TV receiver, the  button allows you to toggle between satellite and terrestrial reception.

Button

Pressing the  button opens the Timer menu (see chapter "Timer Menu").

A further pressure on the  button closes the Timer menu.

Button

Pressing the  button indicates for approx. 3 seconds the satellite position, e.g., "10° EAST".

In addition, this button is used for a variety of other functions (e.g., storing the Timer programme in memory, see chapter "Timer Menu").

Switching the Remote Control Level

So that you can independently control two SAT receivers being operated at a time (e.g., one for TV reception and the other for video recording), it is possible to switch the remote control level.

When switching the receiver on while holding down the ○_{P/F} button on the receiver, the current level "REMOTE 1" respectively "REMOTE 2" is indicated for approx. 3 seconds. At the factory, level 1 (Remote 1) has been preset. When holding down the ○_{P/F} button a longer time when switching on, the receiver will switch to the other level.

Through simultaneously pressing the  (⑧) button on the remote control handset and one of its other command buttons, you can switch to the second command level of the remote control so that you can control a second receiver independently of the first one.

Universal Remote Control Handset

The Telepilot TP 720 SAT supplied with the receiver can be used not only for the satellite receiver STR 400 AP but also for a number of GRUNDIG SAT receivers and equivalent receivers of other manufacturers.

In addition, it can be used for the remote control of a large number of video recorders and TV sets of GRUNDIG as well as of other manufacturers.

Certain GRUNDIG satellite receivers have 2 remote control levels to enable a separate control of 2 receivers in the same room. Your Telepilot also operates with this second remote control level.

At the factory, the Telepilot has been preset so that its main function is the control of the SAT receiver, and its second function the control of TV sets or video recorders.

For this, it is necessary to press the **TV SAT** (8) or **VIDEO** (18) button in addition to the desired function button.

In the following table you will find the infrared code numbers which are necessary for changing the programming.

The factory-preset mode is marked by arrows in the table. If the batteries are removed for a **longer time** or if **the battery change takes a longer time, this basic setting will automatically be recovered!**

You can call up the programmed code numbers on the picture screen by holding down the **VIDEO** (18) button and pressing in addition the **i** (3) button.

Example: Basic setting. The display indicates one after the other:

IR-CODE

30 00 90

30 means: GRUNDIG video recorder IR level 1.

00 means: Main function: SAT receiver.
Second function: TV set.

90 means: GRUNDIG TV sets.

If you hold down the **VIDEO** button (18), you can enter different IR code numbers with the numeric keypad and store with the **OK** (6) button. For this, the on-screen display of the code numbers needs not to be on. As there are no redundant code numbers, you need not enter the entire code sequence but only the code number for the unit you wish to control.

Nr.	VCR transmission mode	Manufacturer (incomplete)
→ 30	Grundig 10 Bit, VCR 1	Grundig, ...
33	Grundig 10 Bit, VCR 2	Grundig, ...
34	RCS-16, VCR 1	others
35	RCS-16, VCR 2	others
36	RC-5, VCR 1	Philips
39	RC-5, VCR 2	Philips
40	AEHA, VCR 1	Blaupunkt, ...
43	AEHA, VCR 2	Blaupunkt, ...
44	Matsushita, VCR 1	Blaupunkt, ...
45	Matsushita, VCR 2	Blaupunkt, ...
46	Thomson-new, VCR 1	Saba, Nordmende, ...
49	Thomson-new, VCR 2	Saba, Nordmende, ...
50	Thomson-old, Model 1	
53	Thomson-old, Model 2	
54	Thomson-old, Model 3	
55	JVC, VCR 1	JVC, Telefunken, ...
56	JVC, VCR 2	JVC, Telefunken, ...
59	Nokia	Nokia
60	Löwe	Löwe
63	Sony, VCR 1	Sony
64	Sony, VCR 2	Sony
65	Sony, VCR 3	Sony
Nr.	Basic level for Sat/TV units	
→ 00	SAT	
09	TV	
Nr.	TV transmission mode	Manufacturer (incomplete)
→ 90	Grundig 10 Bit	Grundig...
93	RC-5	Philips, ...
94	SGS	Telefunken
95	Sony	Sony

TIMER Menu

Timer and Video Recorder

In the Timer menu, it is possible to programme the SAT receiver so that it automatically switches on and off on a certain programme position at certain times for recording with a video recorder which is programmed with the same times. It is possible to switch on and off four different programmes at times and dates of your choice.

Calling Up the Menu

Press the **i** button on the remote control handset to open the Timer menu. If there is no Timer programme stored in memory yet, the display indicates:



While in the Timer menu, the indication "TIMER" is visible in the top right corner of the display.

Press the **i** button again to exit the Timer menu.

Timer Programming

Selecting/checking Timer positions

With the **◀▶** buttons on the remote control handset, you can select one of the four Timer positions.

The display indicates the number of the selected Timer position, e.g., for Timer 3:

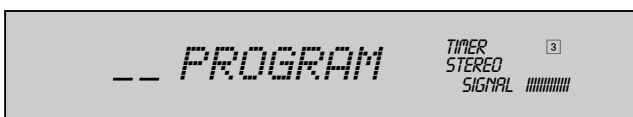

Timer programming is very easy. While viewing a TV programme, you can programme a Timer position for a different TV programme without interrupting the current one. A running VCR recording is not disturbed.

Entering a programme

Enter the number of the desired programme directly with the numeric buttons on the remote control handset, for example, 182.

The display indicates:



If you wish to preprogramme a radio recording, the receiver must be switched from TV to radio with the **RADIO** button or the **⓪** button on the remote control handset before entering the programme position number.

Press the **P+** button to go to the date entry position.

Entering the date

Enter the desired date, for example, 31.05.95, with the numeric buttons on the remote control handset.

The display indicates:

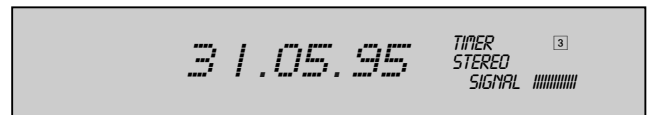

Press the **P+** button to go to the start time entry position.

Entering the start time

Enter the start time directly with the numeric buttons on the remote control handset, for example, start time 20:14 hours.

The display indicates:

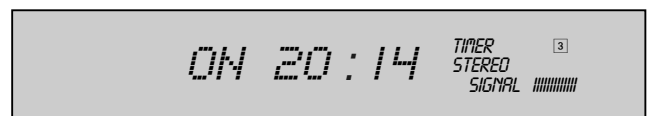

Observe the change of the date when entering a start time after 0 hours.

Press the **P+** button to go to the stop time entry position.

Entering the stop time

Enter the stop time directly with the numeric buttons on the remote control handset, for example, stop time 21:46 hours.

The display indicates:

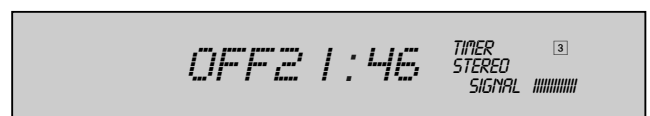

Press the **OK** button to store the entries into memory and go to the next Timer position. Press the **i** button to return to the TV programme.

TIMER Menu

You can only store when in the stop time menu option.

If you exit the Timer menu by pressing the **i** button without storing, the old setting is retained.

Attention!

The entered Timer times must make a sense (start time before stop time). They are not allowed to overlap each other (start time of next Timer position before stop time of preceding Timer position).

If the stop time lies before the start time, Timer operation will be terminated only next day (for example, with 15.40 ... 13.20 hours. However, for recording a programme broadcast between 23.40 and 0.40 hours, this entry makes sense and is necessary).

Timer operation

As soon as the start time is reached, the corresponding programme is switched on. The symbol for the active Timer is flashing (e.g. **1** with Timer 1).

At the same time, a switching voltage is output on the EURO-AV VCR socket. Correspondingly equipped video recorders switch immediately to "AV recording".

When the stop time is reached, the receiver switches to standby and the Timer concerned is automatically cleared.

The switching voltage on the EURO-AV VCR socket is switched off. Correspondingly equipped video recorders switch to "STOP".

During timer operation (flashing Timer symbol), it is not allowed to make any adjustments on the recorder or by means of the remote control handset. This would interfere with Timer recording.

Remote control via a video recorder

If you possess a correspondingly equipped GRUNDIG video recorder, the receiver can remotely be controlled in a very convenient way via the recorder. In this case, preprogramming of up to 8 Timer positions is possible.

The necessary remote control cable can be obtained as GRUNDIG accessory.

The cable must be connected to the video recorder and to the socket **32** (REM. CONTR. VCR) on the receiver (see "Rear of Receiver"). Then, the receiver can be switched to standby. When a programme is recorded, the indication "VCR-REC" is flashing in the display of the receiver. During a video recording, it is not allowed to make any adjustments on the receiver (or with the remote control handset of the receiver). This would interfere with the recording.

Clearing a Timer position

It is possible to clear a programmed Timer position in the following way:

Press the **i** button to open the Timer menu.

Select the desired Timer position with the **◀ ▶** buttons.

(The above steps are not necessary if you are already in the Timer menu and the desired Timer position is selected).

Press the **▽** button.

The display indicates:

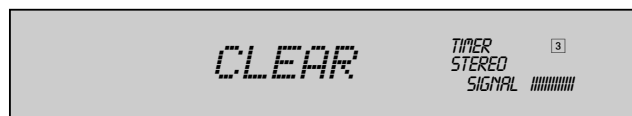

Now, if you press the **OK** button, the selected Timer position is cleared and the Timer menu is automatically exited.

If you press the **△** button instead, the Timer position will not be cleared and you can change the set values.

Indicating the Timer functions

During normal operation, the symbols of all programmed Timer positions are illuminated in the receiver's display.

When the Timer menu is active, the indication "TIMER" and the symbol of the selected Timer are visible in the display.

During Timer operation, the symbols of the programmed Timer positions are illuminated and the symbol of the active Timer is flashing.

Specification

Reception range:	Satellite signals of 10700 ... 13000 MHz, according to used LNC, (Ku-band) C- and S-band frequencies: 2500 ... 4000 MHz IF input of tuner: 910 ... 2050 MHz, two signal inputs (A, B)
Tuning system:	Frequency synthesizer with direct frequency entry. Forward in 10 MHz steps. Reverse in 3 MHz steps. Single steps of 0.5 MHz; corresponds to finetuning.
Frequency search:	ATS (Automatic Tuning System) for horizontal and vertical polarisation.
Programmes:	199 TV programmes, 199 radio programmes.
Last station memory:	For TV and radio
Sound IF:	Direct frequency entry of 5.00 ... 9.99 MHz, in 10 kHz steps.
Audio deemphasis:	With main carrier, Mono, MONO < >, selection possible between J 17 and 50 µsec.
Video deemphasis:	FBAS Baseband: non-clamped PAL-deemphasis 10 MHz Baseband: non-clamped non-deemphasis 10 MHz
Stereo:	PANDA-Wegener-Licence
Remote control:	TP 720 SAT universal remote control handset.
Display:	VF display: 2 ¹ / ₂ -position 7-segment display, 8-position dot matrix, labels.
Timer:	4-position Timer for switching on/off TV or radio programmes.
Modulator:	Frequency synthesizer: UHF CH 25 ... CH 60, CH 36 factory-preset.
LNC feed-in:	14/18 V, max. 800 mA, LNC voltage with superimposed 22 kHz switching signal selectable. If necessary, the LNC voltage can be switched off with switch ④.
Connections:	10-pole connector strip for controlling the external unit. 3 EURO-AV sockets (TV, decoder, and video recorder) with full-automatic socket switching. 3 Cinch (phono) sockets (AF-Audio L and R, and remote control) 2 IEC coax sockets 75 Ω (terr. aerial input/output) 2 IEC coax sockets 75 Ω (SAT aerial input/output "A" and "B") 1 socket 15 V/0.8 A =
Temperature range:	Ambient temperature 0 °C ... + 40 °C, according to VDE 0860
Mains voltage:	220 ... 240 V~, 50/60 Hz (control range of mains unit 190 ... 264 V)
Power consumption:	25 W during operation (without motor run); 13 W in standby
Cabinet:	(WxHxD) approx. 360x84x285 mm ³
Weight:	approx. 2.1 kg
German Federal Post Office certification:	BZT KU 00705

This device is interference suppressed in accordance with applicable european standards. It complies with safety directive VDE 0860 and thus with the international safety regulation IEC 65.

This device must only be operated with the cable supplied. This prevents disturbances from the mains and is an integral component of the device. If a replacement is required, order only the mains cable set with the designation GWN 9.22 / Number 8290.991-316, from a customer service agency.

Subject to change without notice

Pin Assignment of the EURO-AV Sockets

If you want to connect auxiliary units (for example, a video recorder or decoder), your dealer can make a standard connection by means of the following connection table:

Pin	Signal	TV	Decoder	VCR
1	= Audio output, right	x	x	x
2	= Audio input, right		x	x
3	= Audio output, left	x	x	x
4	= Audio, earth	x	x	x
5	= Blue, earth	x	x	
6	= Audio input, left		x	x
7	= RGB, blue	0	l	
8	= Switching voltage	0	l	l
9	= Green, earth	x	x	
10	= -			
11	= RGB, green	0	l	
12	= -			
13	= Red, earth	x	x	
14	= Earth	x	x	x
15	= RGB, red	0	l	
16	= RGB, switching voltage	0	l	
17	= Video, earth	x	x	x
18	= RGB, switching voltage earth	x	x	
19	= Video output	x	x ¹⁾	x
20	= Video input		x	x
21	= Screen/earth	x	x	x

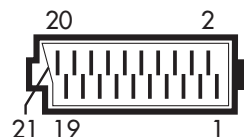

1) Assignable per programme with baseband (see chapter "Decoder" and "Norm 1...3").
 0 = Output
 l = Input

Additional Information for Units sold in Great Britain

Units sold in GB are suitable for operation from a 240 V AC, 50 Hz mains supply.

In case this appliance is supplied with a Safety Standard Approved mains lead fitted with a non-rewireable 13 Amp mains plug which, if unsuitable for your socket, should be cut off and an appropriate plug fitted by a qualified electrician. The fuse and fuse holder must be removed from the plug as accidental insertion of the redundant plug into a 13 Amp socket is likely to cause an electrical hazard.

Note: The severed plug must be destroyed to avoid a possible shock hazard should it be inserted into a 13 Amp socket elsewhere.

If it is necessary to change the fuse in the non-rewireable plug, the correct type and rating (5 Amp ASTA or BSI approved BS 1362) must be used and the fuse cover must be refitted. If the fuse cover is lost or damaged the lead and plug must not be used until a replacement is obtained. Replacement fuse covers should be obtained from your dealer.

If a non-rewireable plug or a rewireable 13 Amp (BS 1363) plug is used, it must be fitted with a 5 Amp ASTA or BSI approved BS 1362 fuse. If any other type of plug is used it must be protected by a 5 Amp fuse either in the plug or at the distribution board.

Important:

The wires in the mains lead are coloured in accordance with the following code:

BLUE – NEUTRAL
 BROWN – LIVE

As the colours of the wires in the mains lead of your appliance may not correspond with the coloured marking identifying the terminals in your plug, proceed as follows:

Connect the BLUE coloured wire to plug terminal marked with the letter "N" or coloured black.

Connect the BROWN coloured wire to the plug terminal marked with a letter "L" or coloured red.

In no circumstance must any of the wires be connected to the terminal marked with a letter "E", earth symbol \perp , coloured green or green and yellow.

Replacement mains lead can be obtained from your dealer.

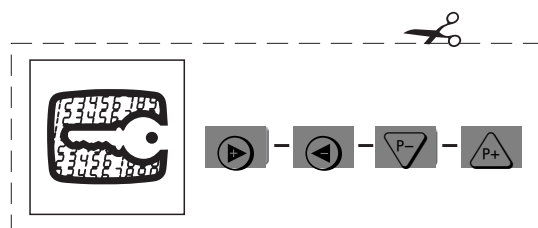

GRUNDIG AG • D - 90762 FÜRTH



4/10 Mü

21107-941.63

2 3 4 5 6 7 8 9

Free Manuals Download Website

<http://myh66.com>

<http://usermanuals.us>

<http://www.somanuals.com>

<http://www.4manuals.cc>

<http://www.manual-lib.com>

<http://www.404manual.com>

<http://www.luxmanual.com>

<http://aubethermostatmanual.com>

Golf course search by state

<http://golfingnear.com>

Email search by domain

<http://emailbydomain.com>

Auto manuals search

<http://auto.somanuals.com>

TV manuals search

<http://tv.somanuals.com>