

**DVD HOME
CINEMA MICRO
SYSTEM**

**G
I
D
I
U
I
R
I
G
I
N
A
L
E
D
I
T
I
O
N**

**Scenos
UMS 4400 DVD**

**DEUTSCH
ENGLISH
FRANÇAIS
ITALIANO**

CONTENTS

4	Scenos UMS 4400 DVD
4	Special features of your DVD Micro System
4	Packing contents
5	Set-up and safety
6-14	Overview
6-7	The front of the DVD Micro System
8-9	The displays of the DVD Micro System
10	The back of the DVD Micro System
11	Operating controls and connections of the subwoofer
12-14	The remote control
15-18	Connection and preparation
15	Connection diagram for the loudspeakers
15	Setting up the loudspeakers
16	Connecting the loudspeakers
16-17	Connecting a television, a flat screen or a projector
17	Connecting external devices digitally
18	Connecting the antennas
18	Connecting the power cord
18	Inserting batteries in the remote control
19	Additional information for units sold in the UK.
20-24	Settings
20	Setting the time
20	General information
21-22	Setting the video functions
22	Setting the loudspeaker configuration
22-23	Setting the audio functions
24	Tuning and storing radio stations
25-26	General functions
25	Switching on and off
25	Selecting the input source
25	Inserting a disc
25	Removing discs
25	Adjusting the volume
26	Muting
26	Selecting sound settings
26	General information on disc playback
27-28	Disc features
27	Disc formats
27	DVD features
27-28	VCD/S-VCD features
28	MP3 CD features
28	Audio CD features
28	JPEG Picture CD features

CONTENTS

29-34

- 29 Playback functions
- 29 Selecting titles or chapters
- 30 Selecting titles or chapters (in DVD mode)
- 30 Playback with PBC (playback control) (in Video CD mode)
- 31 Playback with progressive scan (in DVD mode)
- 31-32 Displaying information
- 32-33 Additional playback functions
- 34 Zero setting (GO TO)
- 34 Selecting and playing scenes
- 35 Playing back tracks or titles in random order
- 35 Repeat functions
- 36 Creating a track memory – playing back titles or tracks in selected order

Disc mode

37-38

- 37 Selecting the tuner input source
- 37 Selecting the waveband
- 37 Calling up stored radio stations
- 37-38 RDS station service

Tuner mode

39-40

- 39-40 Switch-on timer
- 40 Sleep timer

Timer mode

41

- 41 Changing the child lock settings
- 41 Changing the parental lock access code

Child lock

42-43

- 42 Setting the picture mode
- 42 Displaying the multi-angle symbol
- 42 Activating and deactivating the status line
- 43 Language settings

Additional settings

44-46

- 44-45 Technical data
- 45 General instructions for laser devices
- 45 Cleaning discs
- 46 Rectifying minor problems

Information

SCENOS UMS 4400 DVD

Special features of your DVD Micro System



Your DVD Micro System provides you with perfect digital video playback in studio quality.

It also provides superb cinema-quality audio playback – in stereo or with digital multi-channel sound – depending on the type of DVD or CD used.

In addition to DVDs, you can also play S-Video CDs, MP3 CDs or WMA CDs, audio CDs and JPEG picture CDs. In addition to this the DVD Micro System reads home-made DVD Rs and DVD RWs with video data or CD-Rs and CD-RWs with Audio data.

Packing contents

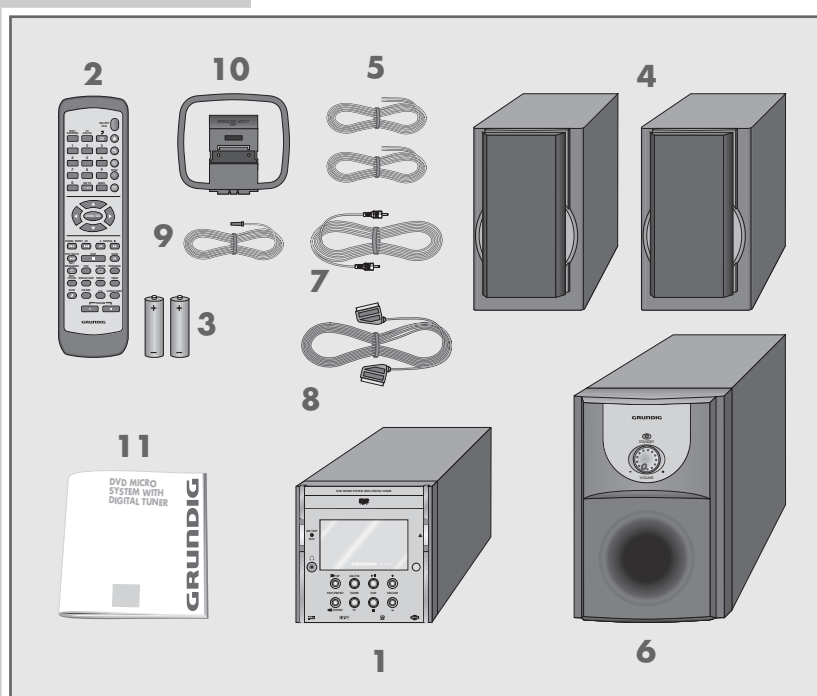

- 1 DVD Micro System Scenos UMS 4400
- 2 Remote control
- 3 Two batteries, 1.5 V, Mignon type, UM 3/R 6/AA
- 4 Two front loudspeakers
- 5 Two loudspeaker cables
- 6 Active subwoofer
- 7 Subwoofer cable
- 8 Euro/AV (Scart) cable
- 9 FM wire antenna
- 10 AM frame antenna
- 11 Operating manual

SET-UP AND SAFETY

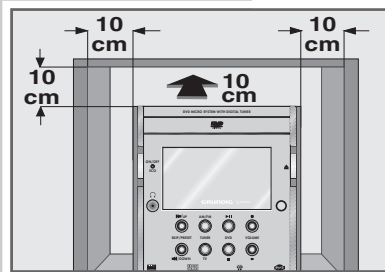

Please note the following information when setting up the home cinema system:

The DVD Micro System and loudspeakers are designed for playing back video and audio signals at use. Any other use is expressly prohibited.

If you want to set up the DVD Micro System on wall shelves or in cupboards, please ensure that it is adequately ventilated. There must be at least 10 cm space at the side, above and at the back of the device. When setting up the subwoofer, make sure that there is at least 20 cm of space at the side, above and at the back of the device. Wherever possible the subwoofer should be set up so that it stands freely.

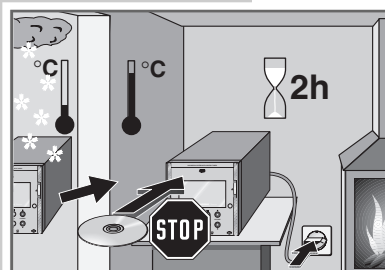

If the DVD Micro System and loudspeakers are subjected to sudden changes in temperature, for example if they are brought in from the cold to a warm room, let them stand for at least two hours. Do not connect them to the mains supply during this time.

The DVD Micro System and loudspeakers are designed for use in dry rooms. If you do use them in the open, please ensure that they are protected from moisture, such as rain or water splashes.

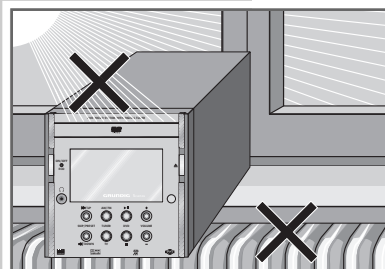

Place the DVD Micro System on a hard, level surface. Do not place any objects such as newspapers on the DVD Micro System or cloth or similar items beneath it.

The laser lens is sensitive to temperature. Therefore, do not place the DVD Micro System near heating units or in direct sunlight, as this will impair cooling.

Do not insert foreign objects in the disc compartment of the DVD Micro System. Never open the casing of the DVD Micro System and loudspeakers. No warranty claims are accepted for damage resulting from improper handling.

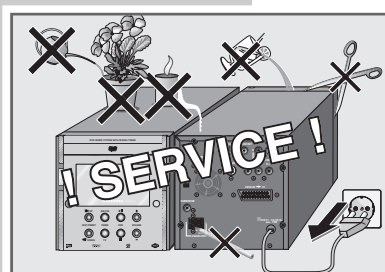

Do not place any vessels such as vases containing fluid on the DVD Micro System and loudspeakers. These may be knocked over and spill fluid on the electrical components, thus presenting a safety risk. Do not place any objects such as burning candles on the DVD Micro System or loudspeakers.

Thunderstorms are a danger to all electrical devices. Even if the DVD Micro System is switched off, it can be damaged by a lightning strike to the mains. Always disconnect the mains and antenna plugs from the DVD Micro System and the mains cable from the subwoofer during a storm.

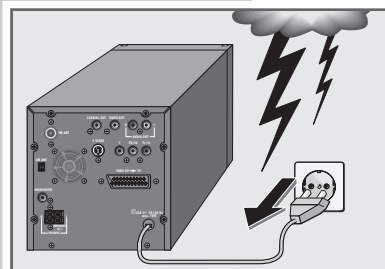

If the DVD Micro System cannot scan DVDs or CDs perfectly, use a commercially available cleaning-CD to clean the laser optics. Other cleaning methods may damage the laser optics. Always keep the disc compartment closed to prevent dust from collecting on the laser optics.

This DVD Micro System successfully combines technology and environmental friendliness in its overall design. Only environmentally-friendly, high-quality materials have been used. The batteries included contain no mercury or cadmium. The range of materials used has been deliberately restricted and all the larger plastic parts have been labelled. This means that the DVD Micro System is easily disassembled to make servicing easier and optimise recycling.

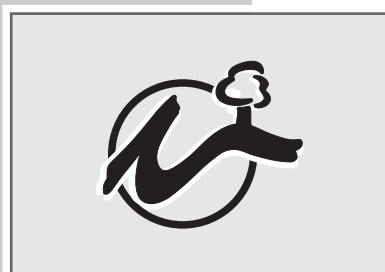

OVERVIEW

The front of the DVD Micro System

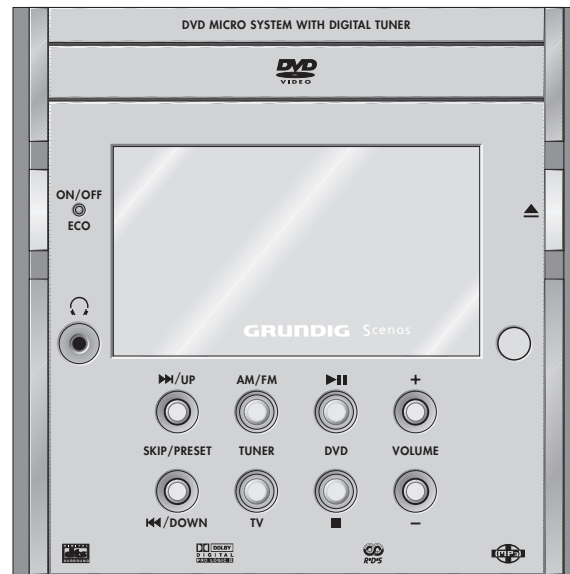

ON/OFF ECO

Press briefly: switches the DVD Micro System to standby and back on again with the last source signal selected.
Hold down: switches the DVD Micro System from standby to eco mode.

The DVD Micro System is only fully disconnected from the mains after the plug has been pulled out.



Standby display. Glows red when the DVD Micro System is switched to standby or to eco mode.



Headphone jack for connecting a stereo headphone set with a jack plug (ø 3.5 mm).

The loudspeakers are switched off automatically. The sound is reproduced in stereo two-channel sound with no surround sound effects.



Opens and closes the disc compartment. Switches the DVD Micro System from standby when opened with DISC selected as the input source.



Infrared receiver for the remote control.

▶▶/UP SKIP/PRESET ◀◀/DOWN

In disc mode – selects the next or previous section or track during playback.

In tuner mode – switches backwards and forwards through the preset positions (saved radio stations) step-by-step.
Hold down: starts the station search mode backwards and forwards.

OVERVIEW



FM TUNER

Selects the TUNER input source (FM). Switches the DVD Micro System from standby with TUNER (FM) selected as the input source.

AM TUNER

Selects the TUNER input source (AM).

TV

Selects TV as external input source.

DVD ► II

Selects DVD as the input source.
In disc mode: starts disc playback; pauses playback.

DVD ■

Ends disc playback.

+ VOLUME -

Adjusts the volume of the system.

The displays of the DVD Micro System



0000:00.00

Displays the disc format, various functions and settings as well as the name or frequency of the radio station.

kHz

In combination with the frequency display for AM (medium wave) reception.

MHz

In combination with the frequency display for FM reception.

DVD

A DVD is being played back.

VCD

A VCD is being played back.

S VCD

An S-VCD is being played back.

MP3

An MP3 CD is being played back.

ROCK

The ROCK sound setting has been activated.

BASS

The BASS BOOST function has been activated.

P.SCAN

The "Progressive Scan" video output format has been selected.

DIGITAL

Dolby Digital indicator.

ALBUM

In MP3 mode: a directory is displayed.

TITLE

In disc mode: a file or a track is displayed.

TRK

In CD-DA mode: a track is displayed.

CHP

In DVD mode: a chapter is displayed.

00

Displays the preset station number or the number of an album or title.

SLEEP

The sleep timer is activated.

OVERVIEW



RANDOM	Plays back the tracks or chapters in random order.
REPEAT	In disc mode: a track or chapter is repeated.
REPEAT ALB	In MP3 mode: a directory is played back repeatedly.
REPEAT TIT	In DVD mode: a title is repeated.
REPEAT ALL	In disc mode: all tracks are repeated.
PROG	Flashes when a program is created. Displays the playback of a program.
TIMER	The switch-on timer is activated. Flashes when the switch-on timer is being set.
TOTAL REMAIN	In CD-DA mode: the remaining playing time is displayed. In DVD mode: the remaining playing time of a chapter is displayed.
	An RDS station is being received.
PTY	The PTY (programme type) function is activated.
((IO	IR display. Flashes when the DVD Micro System receives commands from the remote control.
▶	Indicates disc playback.
	Disc playback has been interrupted (pause, freeze frame).
STEREO	Indicates stereo playback or stereo reception.
MUTING	Flashes when the system has been muted.

Die Rückseite des DVD Micro Systems

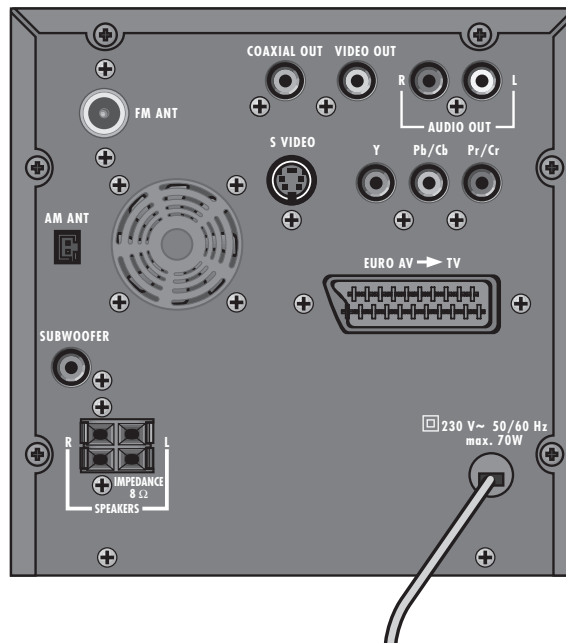

- FM ANT** Connection socket for the FM antenna.
- AM ANT** Connection socket for the AM frame antenna supplied.
- COAXIAL OUT** Coaxial audio signal output for connecting an external device.
- VIDEO OUT** Alternative video signal output for connecting the television using a conventional cinch cable.
- R AUDIO OUT L** Sound signal output for connecting the television using a conventional cinch cable.
- S-VIDEO OUT** Alternative video signal output for connecting the television using a conventional Y/C cable.
- Y Pb/Cb Pr/Cr** Progressive scan outputs for connecting the television using a conventional component cable.
- EURO AV → TV** Euro AV (Scart) socket for connecting the television using the Euro-AV cable supplied.
- SUBWOOFER** Signal output for connecting the supplied subwoofer.
- SPEAKERS** Terminals for connecting the front loudspeakers supplied.
IMPEDANCE 8Ω
- 230 V~** Power cord.
50/60 Hz The only way to disconnect the device from the mains supply is to pull out the plug.

OVERVIEW

Operating controls and connections of the subwoofer

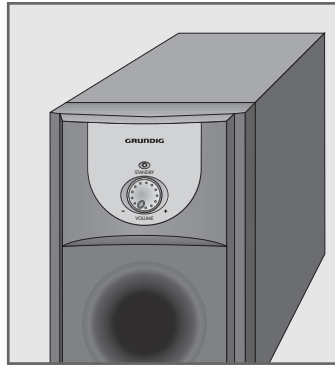

STANDBY

Operating indicator (on front of device). Lights up green during operation, and red in stand-by.

- VOLUME +

Controller for regulating the bass volume (front side of the device). Ideally, the recess of the knob should be set to »+« (maximum) during operation. If the knob is turned all the way to »-«, the subwoofer switches to stand-by.

PHASE 0° 180°

Phase switch (on back of device).

Note:

The phase is usually determined by the DVD Micro System. Depending on the position of the subwoofer and the distance to the listener, switching over the phase can improve the quality of the bass playback.

SUBWOOFER IN

Connection socket for the subwoofer cable (back of the device).

ON/OFF IO

Mains switch. Switches the subwoofer off and on again. Voltage supply is interrupted when switched off.

230 V~ 50/60 Hz

Power cord (on back of device).

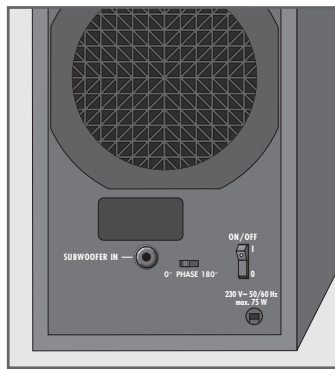

The remote control



ON/OFF ECO

Press briefly: switches the DVD Micro System to standby and back on again with the last source signal selected.
Hold down: switches the DVD Micro System from standby to eco mode.

DISC/RANDOM

Selects DISC as the input source. Switches the DVD Micro System on from standby with DISC as the input source. Plays back tracks in random order.

TV AM/FM

In television mode (»TV-11«) switches the TV sound to the loudspeakers of the DVD Micro System.
Selects TUNER as the input source. Switches the DVD Micro System on from standby with TUNER selected as the input source.
Switches between the FM and AM frequency bands.



In DVD mode: switches the DVD settings between different dubbed languages.
In VCD/S-VCD mode: selects the audio channel.
In tuner mode: switches between stereo and mono playback.



Opens and closes the disc compartment.



Selects the DVD settings appropriately during playback of various camera angles for certain scenes or passages on the DVD.



Zooms in on scenes during playback.

SETUP

Calls up the set-up menu of the DVD Micro System on the television screen when the system is switched to disc mode and the disc is stopped.



In program mode, deletes the current disc program.
Deletes the current bookmark when setting bookmarks.

MENU

Calls up the DVD settings according to the menu of the DVD.

GOTO

In DVD mode: for selecting a chapter or title.
In VCD/CD mode: selects the desired starting point for playback (in VCD mode, PBC must be switched off for this).

1 ... 0

Numerical buttons for various inputs.
In disc mode: selects tracks or files directly.
In tuner mode: selects station positions directly.



Move the cursor up and down in the set-up menu (on the TV screen).

OVERVIEW



Move the cursor left and right in the set-up menu (on the TV screen).

DEMO/OK

In standby, switches the demo program on and off.
Activates the selected setting and confirms entries in the set-up menu.

DOWN PRESET UP ◀◀ ▶▶

In disc mode: selects the previous or next track, the previous or next chapter or file.
In tuner mode: Switching channels up and down.

- TUNING + ◀◀ ▶▶

For setting the clock and the timer.
In disc mode: starts fast forward and reverse search.
In tuner mode: switches the frequency up or down further.

PLAY/PAUSE ▶ ||

Starts and pauses playback (freeze frame).

STOP ■

Press once to interrupt playback (Resume), press twice to end playback (stop).

SLOW

Switches to freeze frame forwards during DVD and VCD/S-VCD playback, switches through freeze frames step-by-step.

PBC/BOOKMARK 📌

Switches the PBC (Play Back Control) function on and off in VCD/S-VCD mode.
Calls up the menu for setting bookmarks in DVD mode.

TITLE

In CD-DA and VCD/S-VCD mode: calls up the intro function when the system is stopped.
Calls up the DVD settings according to the track menu of a DVD.

SUBTITLE ☐

For selecting and displaying subtitles of the DVD during playback according to the DVD prerequisites.

PROGRAM

In disc mode: opens the function for storing a track memory (PROGRAM).
In tuner mode: opens the function for storing radio stations in preset channel positions.

RDS/P.SCAN

In disc mode: switches the output format of the picture signal between interlace and progressive scan.
In tuner mode: calls up RDS functions.

DISPLAY/DIM

Press briefly: switches the screen display and the display of the DVD Micro System between various information displays relating to chapter /track number and playback duration in disc mode.
Press and hold down: switches the display of the DVD Micro System between DIM HIGH, DIM LOW and LED OFF.

OVERVIEW



REPEAT

In DVD mode: for repeating a chapter or title.
In CD mode: for repeating a track, a file (MP3), all tracks or all files (MP3).

TIMER

Press briefly: switches the switch-on timer on and off.
Press and hold down: activates the switch-on timer setting.

MUTE

Switches the system to and from mute mode.

EQ/BBS

Press briefly: selects the sound settings FLAT, CLASSIC, ROCK, JAZZ or POP.
Hold down: switches the BBS (/bass boost) function on and off.

A - B

In disc mode: marks a section, which is then constantly repeated.

CLOCK/SLEEP

Press briefly: displays the current time in the receiver display.
Hold down: activates the sleep timer setting.

- VOLUME +

Adjust the volume of the system.

CONNECTION AND PREPARATION

Connection diagram for the loudspeakers

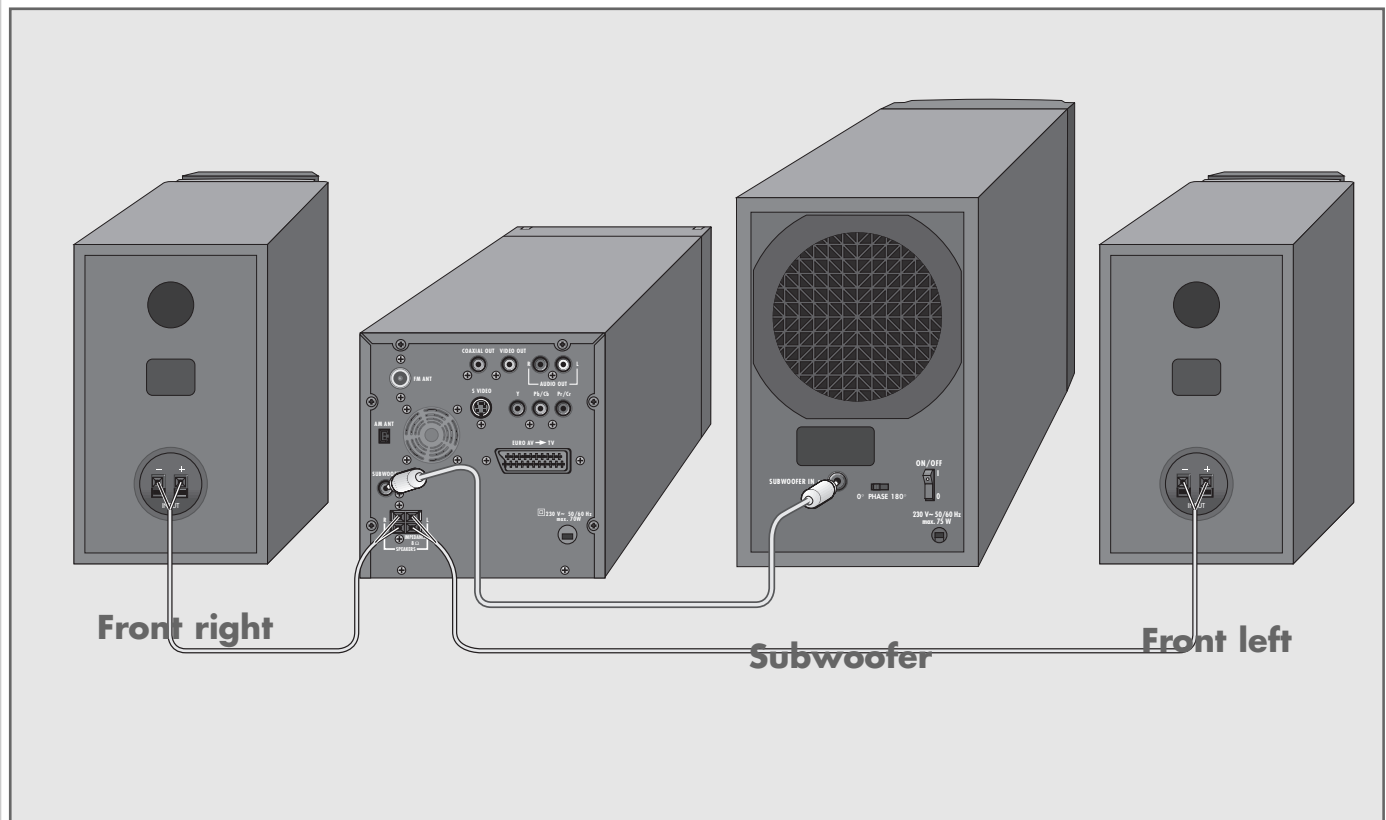

Setting up the loudspeakers

If possible, set up the front loudspeakers in line with the TV set, angled slightly towards the listener. The listener and the speakers should form an equilateral triangle. You thus achieve the best stereo effect.

To achieve an optimal bass sound, we recommend that you set up the subwoofer to the left or right of the front loudspeakers, in such a way that the sound crosses the room diagonally.

When you are in the centre of the room, you may not be able to pick up the bass tone of the subwoofer sufficiently. This is caused by what are called standing waves, which occur between parallel walls. In this case, it is sufficient to position the subwoofer facing the wall at an angle, or to switch the phase switch »**PHASE 0° 180°**« on the subwoofer.

Avoid placing the loudspeakers in a corner, because this over-amplifies the bass tones.

Objects in front of the loudspeakers significantly impair the treble tones and the stereo effect.

CONNECTION AND PREPARATION

Connecting the loudspeakers

Note:

To connect the loudspeakers, switch off the DVD Micro System and disconnect the mains.

When you connect the loudspeaker cables, do not let frayed ends protrude, as this can cause short circuits.

Note:

Connect the red loudspeaker cable to the red terminals, and the black cable to the black terminals.

Connecting the front loudspeakers

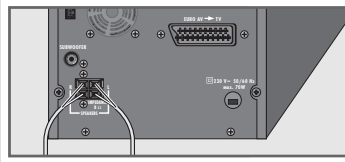

- 1 Connect the cables for the left and right front loudspeakers to the »**SPEAKERS IMPEDANCE 8Ω**« terminals on the DVD Micro System and the appropriate terminals on the loudspeakers (red cable to the red terminal, black cable to the black terminal).

Connecting the active subwoofer

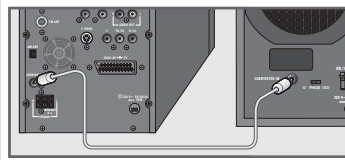

- 1 Connect the cables for the subwoofer to the »**SUBWOOFER**« socket on the DVD Micro System and the »**SUBWOOFER IN**« socket on the subwoofer.

Connecting a television, a flat screen or a projector

You have four options, depending on the sockets you have on your television, flat screen or projector:

- Connection to the Euro-AV (Scart) socket using the Euro-AV cable supplied is the quickest and easiest method which also produces the best results.
- If your television has no Euro-AV socket, you can still achieve a good picture quality by connecting it via the S-VIDEO sockets.
- Alternatively, you can connect it using cinch cables to the VIDEO OUT sockets for standard picture quality.
- Good picture quality is ensured if you connect the television to the Y, Pb/Cb, Pr/Cr video sockets using a component cable.

Connection using a EURO-AV (Scart) cable

This connection option is recommended by the manufacturer.

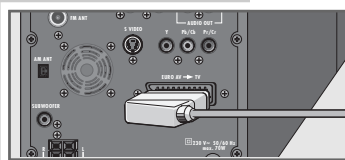

- 1 Plug the EURO-AV cable supplied into the »**EURO AV → TV**« socket of the DVD Micro System and into the corresponding socket on the television, flat screen or projector.

CONNECTION AND PREPARATION

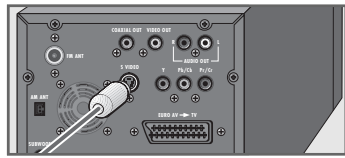

Connection using a Y/C (S-Video) cable and a cinch cable

- 1 Plug a standard Y/C cable into the »**S-VIDEO OUT**« socket on the DVD receiver and the corresponding socket (S-VIDEO IN) on the television, flat screen or projector.
- 2 Plug a standard cinch cable into the »**AUDIO OUT L R**« sockets on the DVD receiver and the corresponding sockets (AUDIO IN) on the television, flat screen or projector.

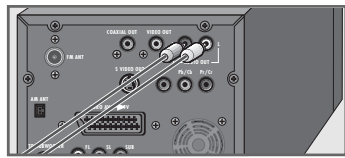

Connecting using a cinch cable

- 1 Plug a standard cinch cable into the »**VIDEO OUT**« socket on the DVD Micro System and the corresponding socket (VIDEO IN) on the television, flat screen or projector.
- 2 Plug a standard cinch cable into the »**R AUDIO OUT L**« sockets on the DVD Micro System and the corresponding sockets (AUDIO IN) on the television, flat screen or projector.

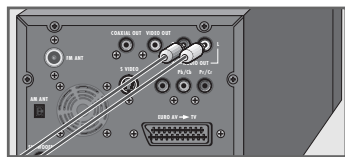
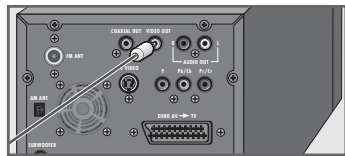

Connecting using a component and cinch cables

- 1 Plug a standard component cable into the »**Y**«, »**Pb/Cb**« and »**Pr/Cr**« sockets of the DVD Micro System and into the corresponding sockets (Y, Pb/Cb, Pr/Cr) on the television, the flat screen or the projector.
- 2 Plug a standard cinch cable into the »**R AUDIO OUT L**« sockets of the DVD Micro System and the corresponding sockets (AUDIO IN) of the television, flat screen or audio projector.

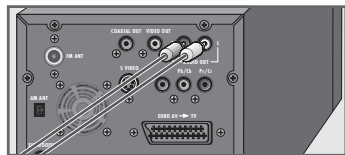
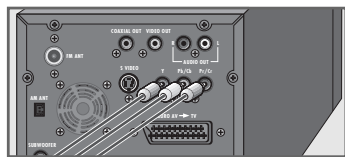

Connecting external devices digitally

You can connect external devices, such as a digital recording device for disc operation. A coaxial output (»**COAXIAL**«) is available for this purpose. The digital output must be activated and set in the set-up menu (see page 21).

- 1 Connect the input sockets of the external devices with the corresponding output socket of the DVD Micro System.



Connecting an external 5.1 CH receiver

- 1 Connect the coaxial input of the external receiver with a standard coaxial cable to the »**COAXIAL**« socket of the DVD Micro Systems
- 2 Connect the video input socket of the external receiver with a standard cinch cable to the »**VIDEO OUT**« socket of the DVD Micro System.



CONNECTION AND PREPARATION

Connecting the antennas

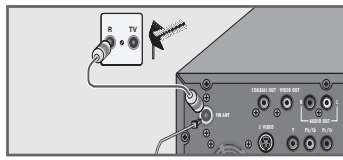

- 1 Plug the antenna cable of the rooftop antenna into the FM antenna socket »FM ANT«.

Note:

If no rooftop antenna is available, use the auxiliary antenna supplied. This antenna provides reasonably good reception of local FM (VHF) stations. Do not shorten the auxiliary antenna.

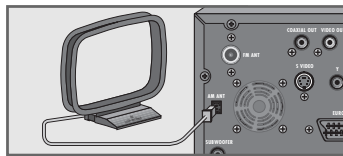

- 2 For medium wave reception, plug the antenna cable of the supplied MW frame antenna in to the »AM ANT« socket.

Note:

In order to prevent interference, place the MW frame antenna as far as possible from the system.

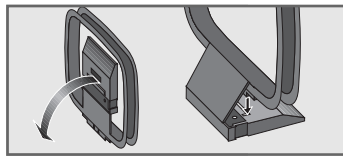

Connecting the power cord

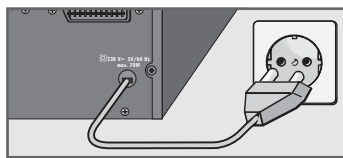

- 1 Insert the plug of the DVD Micro System (»230 V~ 50/60 Hz«) in the socket.

Note:

If the DVD Micro System does not react when the buttons are pressed, this may be caused by electrostatic discharge in the area. In this case pull out the mains plug and insert it into the socket again after a few seconds.

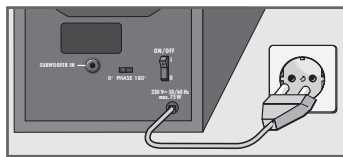

- 2 Insert the subwoofer power cord plug (»230 V~ 50/60 Hz«) into the socket.

Inserting batteries in the remote control

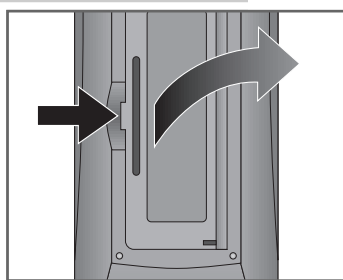

- 1 Open the battery compartment by pressing the marked latch and lifting the lid.
- 2 When inserting the batteries (Mignon type, 2 x 1.5 V, UM 3/R 6/AA) observe the polarity marked in the battery compartment.
- 3 Close the battery compartment.

Note:

If the DVD Micro System no longer reacts properly to remote control commands, the batteries may be flat. Be sure to remove used batteries. The manufacturer accepts no liability for damage resulting from leaking batteries.

Environmental note:

Batteries, including those which contain no heavy metal, may not be disposed of with household waste. Please dispose of used batteries in an environmentally sound manner. Find out about the legal regulations which apply in your area.

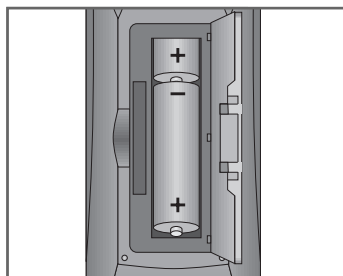

Additional information for units sold in the UK.

Units sold in the UK are suitable for operation from a 240V ac, 50Hz mains supply.

The range of multi-system receivers is built to work in most European countries. However, the mains plug and socket system for the UK differs from many European countries.

This appliance has been supplied with a fitted, non-removable, approved converter plug for use in the UK. This converter plug is fitted with a 5A rated fuse.

In case this appliance is supplied with a moulded 2-pin Euro plug only, which is unsuitable for UK operation, this must be cut off and immediately disposed of. An approved 13A, 3-pin UK plug should then be fitted by a qualified electrician.

Note:

The severed Euro plug must be destroyed to avoid a possible shock hazard should it be inserted into a socket elsewhere.

If a non-rewireable 3-pin plug or a rewireable 13A (BS1363) 3-pin plug is used, it must be fitted with a 5A ASTA or BSI approved BS1362 fuse. If any other type of plug is used it must be protected by a 5A fuse either in the plug, or at the distribution board. If this type of plug becomes defective, ensure that the fuse is removed before disposal, to eliminate potential shock hazard.

If it is necessary to change the fuse in the non-rewireable plug, the correct type and rating (5A ASTA or BSI approved BS1362) must be used and the fuse cover must be refitted. If the fuse cover is lost or damaged, the lead and plug must not be used until a replacement is obtained. Replacement fuse covers should be obtained from your dealer.

Important:

The wires in the mains lead are colour coded in accordance with the following code:

BLUE – NEUTRAL

BROWN – LIVE

As the colours of the wires in the mains lead of your appliance may not correspond with the coloured marking identifying terminals in your plug, proceed as follows:

Connect the BLUE coloured wire to plug terminal marked with the letter "N" or coloured black.

Connect the BROWN coloured wire to the plug terminal marked with the letter "L" or coloured red.

In no circumstance must any of the wires be connected to the terminal marked with the letter "E", earth symbol "⏏", coloured green, or green & yellow.

Replacement mains lead sets can be obtained from your local dealer, or by contacting Grundig Consumer Relations (01788 570088)

Moulded 3-pin lead set, suitable for UK use:

Ref: Leadset UK 8290-991-224

Moulded 2-pin Euro lead set, not suitable for UK use:

Ref: Leadset Euro 8290-991-316

SETTINGS

Setting the time

When the DVD Micro System is connected to the mains for the first time, a demo program runs in the display. This can be interrupted with »**DEMO/OK**«. Afterwards the clock flashes to indicate that it needs to be set. The following settings may only be performed in standby mode. During the setting, if no button is pushed for more than 10 seconds, the DVD Micro system ends the procedure automatically. You then have to start again.

24 HOUR

- 1 To set the 24 hour format press »**PROGRAM**« and hold it down.
– Display: »24 HOUR«, »24« flashes.

12 HOUR

- 2 To set the 12 hour format, press »**TUNING** ◀◀« or »**TUNING** ▶▶«. – Display: »12 HOUR«, »12« flashes.

14:39

- 3 To set the clock press »**PROGRAM**« again. – Display: the hours flash.

10:39

- 4 Set the hours with »**TUNING** ◀◀« or »**TUNING** ▶▶« and confirm with »**PROGRAM**«. – Display: the minutes flash.

10:23

- 5 Set the minutes with »**TUNING** ◀◀« or »**TUNING** ▶▶« and confirm with »**PROGRAM**«. – Display: the current time.

Notes:

You must reset the time after a power failure or when the mains plug is pulled out.

Some RDS stations transmit an RDS time signal. If RDS time synchronisation is activated on the DVD Micro System (»**SYNCH ON**«) (see page 38), the time is automatically updated when this new information is received.

Time synchronisation can take several minutes, and even with good reception the accuracy depends on the time signal being transmitted. The automatic setting is always activated when the DVD Micro System is switched from standby to tuner mode and receives a suitable RDS station.

General information

You can make the settings required for operating the system in the set-up menu which appears on the television screen.

To do this, switch on the television and switch it to the channel on which the DVD Micro System is set. You can only make settings with the remote control in disc mode when the device is stopped.

Switching on

- 1 Switch on the DVD Micro System from standby by pressing »**DVD** ▶ **II**« on the device or »**DISC/RANDOM**« on the remote control.

SETTINGS

Selecting the menu language

The set-up menu is the control centre of your DVD Micro System. It is called up in disc mode when the device is stopped by pressing »**SETUP**«. Eight languages are available in the set-up menu. The default setting is »**ENGLISH**«.

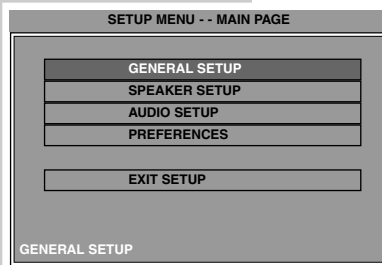

- 1 Press »**SETUP**« to open the set-up menu.
- 2 Select the »**GENERAL SETUP**« menu item with »**▲**« or »**▼**« and confirm with »**DEMO/OK**«.

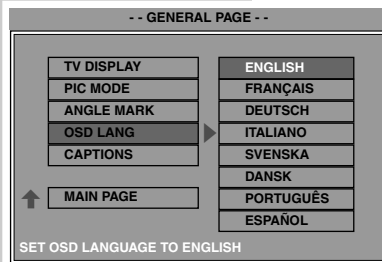

- 3 Select the »**OSD LANG**« line by pressing »**▲**« or »**▼**«.
- 4 Use »**▶**« to move to the right column.
- 5 Select your language using »**▲**« or »**▼**« and press »**DEMO/OK**« to confirm.

Navigating in the set-up menu

Move through the set-up menu with »**▲**« or »**▼**« and select the desired item. The item you select is highlighted and shown in white text.

When you press »**DEMO/OK**« to confirm your selection, a sub-menu with two columns appears. Here too, you can navigate with »**▲**« and »**▼**« and select the item you require in the left column. The item you select is highlighted and shown in white text.

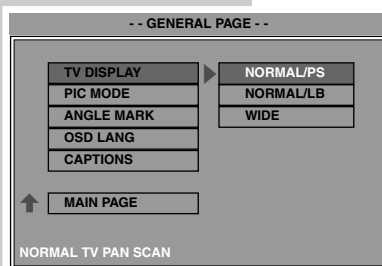

- Press »**▶**« to switch to the column on the right and press »**▲**« or »**▼**« to make the setting. Your chosen setting is highlighted in white text. Press »**DEMO/OK**« to confirm your selection, and the item is highlighted. You can quit the set-up menu by pressing »**SETUP**«.

To make more settings, press »**◀**« to switch back to the left menu and continue as described. You can return to the main menu page by selecting the »**MAIN PAGE**« line with »**▲**« or »**▼**« and confirming with »**DEMO/OK**«. You can also exit the menu by selecting the »**EXIT SETUP**« line with »**▲**« or »**▼**« and confirming with »**DEMO/OK**«.

Setting the video functions

Setting the picture format

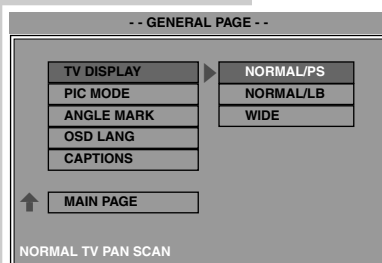

- 1 Select the »**GENERAL SETUP**« menu item with »**▲**« or »**▼**« and confirm with »**DEMO/OK**«.
- 2 Select the »**TV DISPLAY**« line using »**▲**« or »**▼**«.
- 3 Use »**▶**« to move to the right column:
 - »**NORMAL/PS**« for a normal 4:3 television. The large picture is cropped to the left and right. »**NORMAL/PS**« is the default setting,
 - »**NORMAL/LB**« for a normal 4:3 television. This creates a widescreen picture with black bars above and below.
 - »**WIDE**« for a 16:9 large-screen television.
- 4 Select the required setting by pressing »**▲**« or »**▼**« and confirm with »**OK**«.

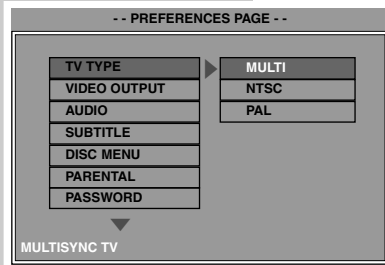

Setting the colour norm for the television

- 1 Select the »PREFERENCES« menu item with »▲« or »▼« and confirm with »DEMO/OK«.
- 2 Select »TV TYPE« with »▲« or »▼«.
- 3 Use »▶« to move to the right column:
 - »MULTI«: PAL or NTSC video signal output is selected automatically in the multi-system.
 - »NTSC«: PAL video signals are converted to NTSC signals.
 - »PAL«: NTSC video signals are converted to PAL signals. »PAL« is the default setting
- 4 Select the required setting by pressing »▲« or »▼« and confirm with »DEMO/OK«.

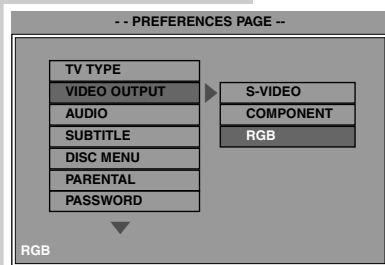

Selecting the video output format

- 1 Select the »PREFERENCES« menu item with »▲« or »▼« and confirm with »DEMO/OK«.
- 2 Select »VIDEO OUTPUT« with »▲« or »▼«.
- 3 Use »▶« to move to the right column:
 - »S-VIDEO«: the television is connected using S-VIDEO.
 - »COMPONENT«: the television is connected using Y, Pb/Cb, Pr/Cr. This setting is a prerequisite for Progressive Scan.
 - »RGB«: the television is connected using the Euro-AV socket. »RGB« is the default value.
- 4 Select the required setting by pressing »▲« or »▼« and confirm with »OK«.

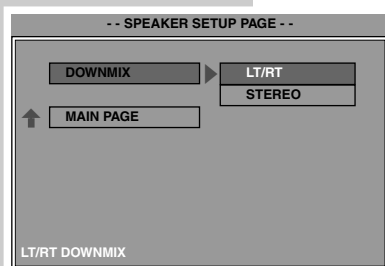

Setting the sound format on the loudspeakers

- 1 Select »SPEAKER SETUP« with »▲« or »▼« and confirm with »DEMO/OK«.
- 2 Select »DOWNMIX« using »▲« or »▼«, change to the right column with »▶«, select the desired setting with »▲« or »▼« and confirm with »DEMO/OK«.
 - »LT/RT«: a downmix is performed on the stereo channels which creates a phantom surround effect.
 - »STEREO«: normal 2.1 channel stereo playback.

Setting the audio functions

Activating digital audio signal outputs

You can make the setting for the coaxial output for the connection to an external device here. If the digital outputs are activated, the analog output signal is deactivated.

- 1 Select »AUDIO SETUP« with »▲« or »▼« and confirm with »DEMO/OK«.

SETTINGS

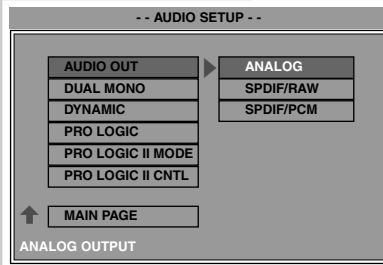

- 2 Select »AUDIO OUT« with »▲« or »▼«.
- 3 Use »▶« to move to the right column.
 - »ANALOG«: the coaxial output is deactivated. »ANALOG« is the default setting.
 - »SPDIF/RAW«: the coaxial output provides the original signal format.
 - »SPDIF/PCM«: the coaxial output changes into the PCM format for digital recording devices.
- 4 Select the required setting by pressing »▲« or »▼« and confirm with »DEMO/OK«.

Multiple channel settings

You can switch the channel playback to Dolby Digital mode if a 1+1 audio code is available i.e. the Dolby Digital signal only contains a stereo signal.

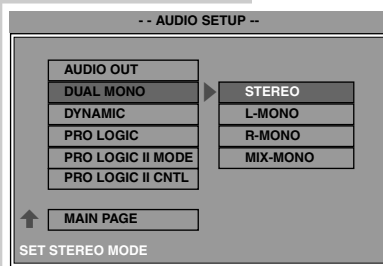

- 1 Select »AUDIO SETUP« with »▲« or »▼« and confirm with »DEMO/OK«.
- 2 Select »DUAL MONO« with »▲« or »▼«.
- 3 Use »▶« to move to the right column.
 - »STEREO«: 1:1 stereo playback, CH1 for the left channel, CH2 for the right channel. »STEREO« is the default value.
 - »L-MONO«: CH1 mono playback, CH1 on left and right channel.
 - »R-MONO«: CH2 mono playback, CH2 on left and right channel.
 - »MIX-MONO«: mixed mono playback, CH1 and CH2 on left and right channel.
- 4 Select the required setting by pressing »▲« or »▼« and confirm with »DEMO/OK«.

Setting the dynamic range

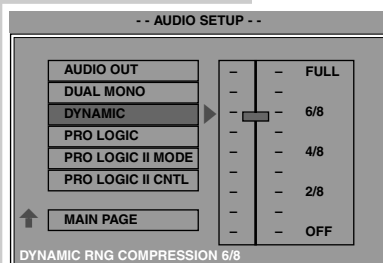

DTS (AC3) soundtracks have a very large dynamic volume range, hence there is an extreme relationship between quiet and loud tones. If the full playback volume is too loud, simply reducing it does not give a satisfactory result, since dialogue can hardly be heard. You can turn down the louder sounds and turn up the quieter passages, while retaining the volume of the dialogue. This function is called the dynamic range.





- 1 Select »AUDIO SETUP« with »▲« or »▼« and confirm with »DEMO/OK«.
- 2 Select »DYNAMIC« with »▲« or »▼«.
- 3 Use »▶« to move to the right column.
 - »OFF«, »2/8« ... »6/8«, »FULL«. »OFF« (default setting) means uncompressed dynamics (for example, during the day), »FULL« means compressed dynamics (for example, late at night).
- 4 Select the required setting by pressing »▲« or »▼« and confirm with »DEMO/OK«.

Setting and storing radio stations

Up to 20 radio stations in the FM range and up to 10 stations in the AM range can be stored. You can see the displays for this on the DVD Micro system.

- 1 Press »**ON/OFF ECO** « to switch on the DVD Micro System from standby mode.
 - The DVD Micro System switches on with the last input source selected.
- 2 Use »**FM TUNER AM**« on the DVD Micro System or »**TV AM/FM**« on the remote control to select TUNER as the input source.
 - Display: e.g. »*FM 87.50* MHz«.
- 3 Press »**FM TUNER AM**« on the DVD Micro System or »**TV AM/FM**« on the remote control to select the desired frequency band (FM or AM).
- 4 To start the search, press »**TUNING** « or »**TUNING** « on the remote control and keep them pressed down until the frequency changes to search mode.
 - The search stops when a station is found.
 - Display: »*SEARCH*«, then »*SEARCHING*« in ticker text display, then »*FM 100.60* MHz« for example.

Note:

To switch through frequencies step-by-step press »**TUNING** « or »**TUNING** « on the remote control briefly repeatedly.

- Display: the frequency in steps of 50 kHz.

- 5 Select the storage function by pressing »**PROGRAM**« on the remote control.
 - Display: »*01*« for the preset position flashes.

Note:

If no button is pressed within 5 seconds, the DVD Micro System automatically quits the storage function.

- 6 Select the desired station position with the »**DOWN PRESET UP**« button.

Note:

you can enter the station position directly using the number buttons »**1... 0**« on the remote control.

- 7 Store radio stations by pressing »**PROGRAM**« on the remote control within five seconds.
 - Display: briefly »*STORED*« as ticker text, then »*1 FM 100.60* MHz« for example.

FM 87.50 MHz

FM 100.60 MHz

FM 98.75 MHz



01
FM 100.60 MHz

1
FM 100.60 MHz

GENERAL FUNCTIONS

Switching on and off

TUNER FM

- 1 Switch on the DVD Micro System from standby or eco mode with »ON/OFF ECO *»*«. – The system switches on with the most recently selected input source.
- 2 Switch the DVD Micro System to standby with »ON/OFF ECO *»*«. – Display on the DVD Micro-System: briefly »BYE BYE« in ticker text.
- 3 Switch the DVD Micro System to eco mode with »ON/OFF ECO *»*« (long press). – Display on the DVD Micro-System: briefly »ECO ON ----« in ticker text. – The displays on the DVD Micro System completely disappear.

Selecting the input source

DISC

NO DISC



- 1 Select the desired input source (DISC, TUNER or TV IN) with »DVD *»* II« or »FM TUNER AM« on the DVD Micro System or »DISC/RANDOM« or »AM/FM TV IN« on the remote control. – Display on the DVD Micro-System: »DISC« or »TUNER FM« for example. – If DISC is selected as the input source and no disc has been inserted beforehand, the DVD Micro System briefly displays »DISC«, then »WAITING«, then »READING« in ticker text, and then »NO DISC«.

Inserting a disc

OPEN

CLOSE

- 1 Press »*»*«. – The disc compartment opens. – Display on the DVD Micro System: »OPEN«.

Note:
If the DVD Micro System is in standby, it is switched to disc mode with »*»*«.
- 2 Insert the disc in the disc compartment with its label facing upwards.
- 3 Press »*»*«. – The disc compartment closes again (display: »CLOSE«). The disc is scanned. – Display on the DVD Micro System: information concerning the inserted medium.

Removing discs

- 1 Open the disc compartment with »*»*«.
- 2 Remove the disc.

Adjusting the volume



VOL 23

- 1 Adjust the volume of the entire system with »+ VOLUME -« on the DVD Micro System or with »- VOLUME +« on the remote control. – Display on the DVD Micro System: »VOL« and the selected value (scale from »MIN«, »1« to »31«, »MAX«).

Muting

With this function the DVD Micro System mutes the connected loudspeakers.

MUTING

- 1 Press »  « on the remote control to switch it on mute.
– Display on the DVD Micro System »**MUTING**« flashes.
- 2 Briefly press »  « on the remote control again to cancel the muting.
– Display on the DVD Micro System: briefly »**MUTING**« after which it disappears.

Selecting sound settings

You can choose between four different sound settings (CLASSIC, ROCK, JAZZ, POP). The default setting is FLAT.

CLASSIC
CLASSIC

- 1 Select the desired sound setting, to do this, press »**PRE EQ/BBS**« on the remote control briefly and repeat.
– Display on the DVD Micro System: briefly »*FLAT*«, »*CLASSIC*«, »*ROCK*«, »*JAZZ*« or »*POP*«, and then »**CLASSIC**«, »**ROCK**«, »**JAZZ**« or »**POP**« are displayed constantly.

General information on disc playback

If the »  « symbol appears on the television screen after entering particular commands, it means the disc itself has a limited set of functions.

DISC FEATURES

Disc formats

Your DVD Micro System can play DVD R/DVD RW in DVD video format and CD-R and CD-RW in CD-DA Format or MP3/WMA format.

Due to difference in quality of the recording media and the quality of the recording itself, it can occasionally happen that a home-made DVD R/DVD RW or CD-R and CD-RW with audio data cannot be read. This does not indicate a malfunction of the DVD Micro System.

The causes for this can be faulty software or hardware settings, or even the CD itself. Should such problems arise, contact the customer services of your CD burner/software manufacturer or search for information about this, for example, on the Internet.

If you make a DVD R/DVD RW or CD-R/CD-RW, please observe the legal regulations and do not infringe the copyright of third parties.

Some recordings (DVD R/DVD RW, CD-R and CD-RW) have to be finalised.

When MP3/WMA-CDs are played back, individual tracks may be skipped or incorrectly played back. This can be due to the disc configuration, the encoder software or the hardware used for the recording.

Audio CDs (CD-DA) meet the specification and bear the corresponding logo. Copy-protected CDs do not meet this specification in some circumstances and do not bear the corresponding logo. These CDs can cause playback errors.



DVD features

You can recognise a DVD by the logo on the label.

Depending on the content of the DVD, the discs contain one or more titles. Each title may contain one or more chapters. Titles and chapters can be selected easily and conveniently.

You can control and direct playback of a DVD using the menu of the DVD Micro System on the television screen.

Many DVDs have audio tracks recorded in up to eight languages. You can select the language you want. Many DVDs are recorded by the manufacturer with subtitles in several languages. You can select subtitles from up to 32 different languages.

Your DVD Micro system has been enabled with regional code 2. DVDs with additional regional codes cannot be played.



VCD/S-VCD features

You can recognise S-VCD/VCDs (video CDs) by the logo on the label.

Depending on the contents of the VCDs/S-VCDs (films, music videos etc.), the discs may carry one or more tracks. Like audio CDs, VCDs/S-VCDs have a track structure.

VCDs/S-VCDs can be created using the PBC (playback control) system for track navigation.



DISC FEATURES

You can control and direct playback of the VCD/S-VCD using the menu of the DVD Micro System on the television screen.

S-VCDs can contain different dubbed languages and subtitles.

PBC (playback control)

PBC is a navigation option for VCDs/S-VCDs. PBC switches between the playlist structure (the menu on the VCD/S-VCD) and manual selection by the user.

PBC is activated after the VCD/S-VCD has been scanned. This function allows interactive playback of the VCD/S-VCD if you follow the menu on the television screen.

MP3/WMA CD features



MP3 stand for MPEG-1 Audio Layer 3, WMA for Windows Media Audio. Both formats enable audio files to be saved on a computer with a sound quality similar to that of a CD. The standard encoding bit rate for MP3 files is 128 kbps. Generally, the higher the bit rate of a file, the better the sound quality.

Most MP3 files on the Internet are encoded at 128 or 160 kbps. 160 kbps is considered CD quality. MP3/WMA files can be downloaded from the Internet and then burned onto a CD ROM disc. MP3/WMA CDs contain only sound recordings.

In MP3/WMA mode, the terms "album" and "file" are very important. "Album" corresponds to a folder on a PC, and "file" to a file on a PC or a CD-DA track.

Audio CD features



An audio CD (CD-DA) is identified by this logo.

Audio CDs contain only sound recordings. They can be played in the normal manner on an audio system. The individual tracks are stored in a sequence. There are no folders.

As well as audio CDs, the DVD Micro System can also read CD-R and CD-RW with audio data.

JPEG Picture CD features

JPEG stands for Joint Picture Experts Group. This process was designed to compress picture files.

JPEG files can be burned onto a CD along with other file types. Such CDs are known as file CDs or mixed mode CDs. For example, the CD could contain MP3 files (audio) and JPEG files (for example to display album covers).

The files on a JPEG CD can be organised in directories. This structure is similar to that of an MP3 CD.

JPEG CDs only contain data in the compressed JPEG format. This is mostly data from digital cameras or from picture processing programs. The data (pictures) can be displayed individually or in sequence in a slide show.

DISC MODE

Playback functions

In DVD mode, playback sometimes starts automatically after the disc has been scanned. Sometimes a menu appears on the screen where you can start disc playback.

A menu also appears on the screen with VCDs/S-VCDs where you can control the playback of the disc interactively if you switch on the PBC function (see page 30).

In MP3/WMA and audio CD modes playback always starts with the first file or track.

PLAY

PAUSE

PLAY

STOP

PRESS PLAY TO CONTINUE

PLAY

STOP

TITLE 01/02 CHAPTER 004/035

TITLE 01/02 CHAPTER 003/035

Playing back the disc

- 1 Start playback in stop mode by pressing »**PLAY/PAUSE** ► **II**«.
- 2 To pause playback (freeze-frame in video mode), press »**PLAY/PAUSE** ► **II**«.
- 3 Press »**PLAY/PAUSE** ► **II**« to resume playback.
- 4 To end playback press »**STOP** ■« twice.

Interrupting/resuming playback (resume)

In DVD mode, you can stop playback at any point and then continue where you left off.

- 1 To interrupt playback, press »**STOP** ■« once.
- 2 Press »**PLAY/PAUSE** ► **II**« to resume playback.
- 3 To stop playback, press »**STOP** ■« twice.

Selecting titles or chapters ...

... step-by-step

- 1 Select the next chapter, next file or next track by pressing »**PRESET** ►►« briefly and repeatedly during playback.
- 2 Select the previous chapter, previous file or previous title with »**PRESET** ◀◀« (press twice for files and titles).
– Playback starts with the selected chapter, file or title.

... directly with the numerical buttons

- 1 During playback, select the desired track with »**1 ... 0**« on the remote control.
– Playback starts with the selected chapter, file or title.

Notes:

Selecting directly using the numerical buttons is only possible, if the disc is supporting this function.

Selecting titles or chapters (in DVD mode) ...

... using the DVD menu

If a DVD contains several titles or chapters, you can select these in the DVD menu, if the DVD itself offers this function.

- 1 Call up the DVD menu with »**MENU**«.
 - The DVD menu appears on the screen.
- 2 Select the title or DVD with »**▲**« or »**▼**« or »**◀**« or »**▶**« and confirm with »**DEMO/OK**«.
 - Playback of the selected title or chapter begins.

... using the title menu of the DVD

Some DVDs offer a title menu which shows the titles and chapters.

- 1 Call up the title menu with »**TITLE**« on the remote control.
 - The title menu appears on the screen.
- 2 Select the title or DVD with »**▲**« or »**▼**« or »**◀**« or »**▶**« and confirm with »**DEMO/OK**«.
 - Playback of the selected title or chapter begins.

Playback with PBC (playback control) (in Video CD mode)

PBC ON

After scanning the disc, the PBC function is activated, provided this function is supported by the disc (»PBC ON« briefly appears).

- 1 Press »**PLAY/PAUSE ▶ II**« to start playback.
 - The DVD Micro System automatically switches to PBC playback mode.
- 2 Select the desired menu option with »**▲**« or »**▼**« or »**◀**« or »**▶**« and activate with »**DEMO/OK**«.
- 3 Follow the instructions given in the menu to use the interactive functions.
- 4 To deactivate the PBC function, press »**PBC/BOOKMARK**« on the remote control during playback.
 - On the television screen »PBC OFF« appears briefly.
 - The playback of the video CD ends.
- 5 Press »**PLAY PAUSE ▶ II**« to start normal playback.

PBC OFF

layback with progressive scan (in DVD mode)

This function results in the transmission of video signals in a high frequency range. The function is only active if the video output has been set to »COMPONENT« in the set-up menu. Before you first switch on the device, please check whether your television, flat screen or projector is suitable for this use.

- 1 Press »**RDS/P.SCAN**« to switch on the function.
 - On-screen display: »PROGRESSIVE TV«.
 - Display on the DVD Micro System: »**P.SCAN**«.
- 2 Press »**RDS/P.SCAN**« to switch off the function.
 - On-screen display: »INTERLACE TV«.
 - Display on the DVD Micro System: »**P.SCAN**« disappears from the display.

PROGRESSIVE TV

INTERLACE TV

Displaying information ...

... in DVD mode:

- 1 Press »**DISPLAY/DIM**« repeatedly on the remote control.
 - One after the other you will receive information concerning the following:
 - Current title number, current track number and the elapsed playing time of the title
 - The remaining playing time of the title
 - The elapsed playing time of the chapter
 - The remaining playing time of the chapter.
- 2 To hide the information line repeatedly press »**DISPLAY/DIM**« on the remote control.

TITLE 01/02 CHAPTER 006/035
00:18:14

... In video CD mode

- 1 Press »**DISPLAY/DIM**« on the remote control repeatedly.
 - You will receive information concerning:
 - The elapsed playing time of the current track
 - The remaining playing time of the track
 - The total playing time of the VCD/S-VCD
 - The remaining playing time of the VCD/S-VCD
- 2 To hide the information line repeatedly press »**DISPLAY/DIM**« on the remote control.

SINGLE ELAPSED
03:38 TRACK 01/01

... In MP3/WMA mode

In MP3/WMA mode, the corresponding information is automatically displayed by the MP3/WMA menu.

In MP3 mode, you can display the name of the artist in the display of the DVD Micro System by pressing »**DISPLAY/DIM**«.

... In audio CD mode

- 1 Press »**DISPLAY/DIM**« repeatedly on the remote control.
 - You will receive information concerning:
 - The elapsed playing time of the current track
 - The remaining playing time of the track
 - The elapsed playing time of the CD
 - The remaining playing time of the CD.

SINGLE ELAPSED
01:07 TRACK 01/19

Additional playback functions

Some of the functions are not available depending on the inserted media.

Fast search

- 1 During playback, press »**TUNING** ◀◀« or »**TUNING** ▶▶« on the remote control.
 - The fast search starts either forwards or backwards.

Note:

The backwards and forwards speed can be changed in four stages by pressing »**TUNING** ◀◀« or »**TUNING** ▶▶« repeatedly during the search. The maximum speed is »16x«.

- 2 Press »**PLAY PAUSE** ▶ II« at the position desired.
 - Normal playback starts.



FF 2x

FF 8x

PLAY

Selecting the camera angle for particular scenes or passages

Many DVDs contain scenes or passages which were filmed by various cameras – from different angles. You can select these different camera angles. Should a DVD offer this function, the multi-angle symbol, for example » 1/4«, will appear on the television screen if it has been set up in the set-up menu.

- 1 To select the camera angle function, press »« during playback.
 - Display: camera angle » 2/4«, 2 from 4 in this example.
- 2 To select another camera angle, press »«.

 2/4

Slow motion

You can switch forwards through individual pictures in small steps.

- 1 During playback, press »**SLOW**« on the remote control.
- 2 Change pictures forwards by pressing »**SLOW**« repeatedly.
- 3 Switch back to playback with »**PLAY PAUSE** ▶ II«.

STEP FWD

PLAY

ZOOM x1.5

ZOOM OFF



AUDIO 2/3: AC - 3 1CH ENGLISH

AUDIO 1/3: AC - 3 1CH SPANISH

SUBTITLE 02/21: ENGLISH



Enlarging the picture (zoom)

This function allows you to enlarge various picture sections. The picture enlargements are selected in the following order: ZOOM1.5 – ZOOM2 – ZOOM3 – ZOOM OFF.

- 1 During playback, in pause or slow motion, press »« on the remote control.
– Display: »ZOOM x1.5«, a picture section is enlarged.
- 2 The picture section can be moved with »▲« or »▼« or »◀« or »▶« on the television screen.
- 3 To end the function switch »« to »ZOOM OFF«.

Switching the dubbed language or the audio format

This setting switches away from the preset dubbed language, if the DVD offers alternatives.



- 1 During playback, press »«.
– Display: the current dubbed language
- 2 Keep pressing »« to select the dubbing language.

Note:

Switching the dubbed language can be suppressed by the structure of the DVD itself. In this case the setting is usually made in the DVD menu.

Selecting and displaying subtitles

If the DVD provides subtitles, they can be displayed on your TV screen. When subtitles are available in several languages, you can select your preferred language.

- 1 During playback, press »SUBTITLE «.
– Display: for example »SUBTITLE 02/21: ENGLISH« appears briefly, then the current subtitles appear.
- 2 Keep pressing »SUBTITLE « to select the subtitle language.

Notes:

Switching the subtitles can be suppressed by the structure of the DVD itself. In this case the setting is usually made in the DVD menu.

Zero setting (GO TO) ...

... in DVD mode

This function enables you to select titles or chapters on the DVD when it is stopped or during playback.

- 1 Call up this function with »**GOTO**« on the remote control.
– The information menu is displayed. The chapter number display is highlighted in yellow.
- 2 Select the title of chapter number with »◀« or »▶«,
- 3 Using the numerical buttons »1 ... 0« on the remote control, enter new title or chapter numbers and confirm with »**DEMO/OK**«.
– Playback of the selected title or chapter begins.
- 4 Press »**GOTO**« on the remote control again.
– The line for the time display appears.
- 5 Enter the desired time with »1 ... 0« and confirm with »**DEMO/OK**«.
– Playback starts at the corresponding point.

... In video CD and CD mode

- 1 Press »**GOTO**« on the remote control.
– The line for the time display appears.
- 2 Enter the desired time with »1 ... 0« and confirm with »**DEMO/OK**«.
– Playback starts at the corresponding point.

Selecting and playing scenes

You can make a bookmark for a scene on a DVD. This bookmark can be selected directly for playback. You can set two bookmarks per DVD.

Setting bookmarks

- 1 During playback, press »**PBC/BOOKMARK**«.
- 2 Select a bookmark using »▼« or »▲«.
- 3 Press »**DEMO/OK**« at the point you wish to mark.

Notes:

Select the second bookmark with »▼« or »▲« and mark a new point.
The bookmark (playing time) can be deleted using »◀«.

Playing bookmarked scenes

- 1 During playback, press »**PBC/BOOKMARK**«.
- 2 Select the bookmark with »▼« or »▲«.
- 3 Select »**GO TO**« with »▶« and confirm with »**DEMO/OK**«.
– Playback starts at the point marked.

TITLE 01/02 CHAPTER 007 /035

TRACK 01/02 TIME

MARK GO TO TOTAL
01 00 00/02

Playing back tracks or titles in random order

If the disc is supporting it, you can play back tracks or titles in random order.

- 1 When the device is stopped, call up the function by pressing »**DISC/RANDOM**«. – Display: shortly »RANDOM ON«.
- 2 Start random playback with »**PLAY/PAUSE** ► **II**«.
- 3 To stop the function press »**STOP** ■« und subsequently »**DISC/RANDOM**«. – Display: shortly »RANDOM OFF«.

RANDOM ON

RANDOM OFF

Wiederhol-Funktionen

Repeating a selected section (A-B Repeat)

You can mark a desired section to be repeated within a chapter, file or title.

- 1 To mark the start of the desired section during playback, briefly press »**A-B**«. – Display: »A TO B SET A «.
- 2 To mark the end of a section, briefly press »**A-B**« again. – Display: »A TO B SET B«, the scene marked in this manner is constantly repeated.
- 3 To cancel this function, press »**A-B**« again. – Display: briefly »A TO B CANCELLED«.

A TO B SET A

A TO B SET B

A TO B CANCELLED

Repeating a chapter, file, title or all chapters, files, or titles on a disc

- 1 During playback, press »**REPEAT**« on the remote control. – Display: briefly, for example »CHAPTER REPEAT ON« a chapter, file or title is repeated.
- 2 During playback, press »**REPEAT**« on the remote control again. – Display: briefly, for example »TITLE REPEAT ON« all chapters, files or titles are repeated.
- 3 Press »**REPEAT**« on the remote control a third time to quit the function. – Display: briefly »REPEAT OFF«.

CHAPTER REPEAT ON

TITLE REPEAT ON

REPEAT OFF

Notes:

This function is not available in Aux mode.

The PBC function must be switched off in video CD mode.

Creating a track memory – playing back tracks in selected order

You can store and then play back up to 99 tracks in a particular order from the inserted disc. A track may be stored more than once. The DVD Micro System must be in the stop position.

This function is not available for DVDs.

PROG

P01 T00

PROG

P02 T03

- 1 Select this function with »**PROGRAM**« on the remote control.
– Display on the DVD Micro System: »P01 T00« and »**PROG**«. »00« flashes.
- 2 Select the desired two-digit track number with the numerical buttons »1 ... 0« (e.g. »05« or »12«) and confirm with »**DEMO/OK**«.
– Display: e.g. »P01« (memory position) and »03« (for the first track).

Note:

To programme further tracks, repeat step 2.

- 3 To start playback of the memory, press »**PLAY/PAUSE** ► **II**«.
– Playback begins with the first programmed track.
- 4 To end playback of the memory press »**STOP** ■«.
– This memory is stored.

Deleting a program

The memory is deleted if:

- When the system is stopped »**PROGRAM**« is held down (on-screen display »PROGRAM OFF«);
- The disc compartment is opened
- The DVD Micro System is switched to standby with »**ON/OFF**«.

TUNER MODE

Selecting the tuner input source



FM 100.60 MHz

- 1 Select the input source with »**FM TUNER AM**« on the DVD Micro System or with »**TV AM/FM**« on the remote control.
 - The most recently selected radio station is played (Last Station Memory).
 - Display on the DVD Micro System: frequency band and frequency, or station name.

Selecting the waveband



AM 1404 kHz

- 1 Select FM (VHF) or AM (medium wave) with »**FM TUNER AM**« on the DVD Micro System or »**TV AM/FM**« on the remote control.
 - Display on the DVD Micro System: »FM« or »AM« and the frequency.

Calling up stored radio stations



06 100.60

- 1 Select the desired preset channel position with »**1 ... 0**« or »**DOWN PRESET**« or »**PRESET UP**« on the remote control.
 - Display on the DVD Micro System: briefly, e.g. »06 100.60 MHz«.

RDS station service

RDS (Radio Data System) is an information system which is provided additionally by most FM stations. If the DVD Micro System is currently receiving an RDS station, the station name, e.g. »ENERGY«, and »« appear in the display.

Searching for RDS stations



ENERGY 

- 1 Search for the desired RDS station by repeatedly pressing »**TUNING** ◀◀« or »**TUNING** ▶▶« until an RDS station is received and »« appears in the display.
 - After a short time the station name appears if the reception strength is sufficient.

Note:

It may take some time before all the RDS information is available.

Calling up RDS information

If an RDS station is being received, various station information can be called up in the display. The information remains in the display as long as no other information is called up.

- 1 Press »**DISPLAY/DIM**« repeatedly.
 - The channel position, waveband and frequency, station name, radio text in ticker text, station type, RDS time, PI code and then the channel position with the waveband and frequency appear in that order.

Switching RDS information on and off

The RDS information can be switched on and off.

INFO OFF

- 1 To call up this function, press »RDS/P.SCAN« twice.
– Display: »INFO OFF« or »INFO ON«.
- 2 Press »PROGRAM« to switch RDS information on or off.

Searching for station types (PTY)

NEWS

PTY

- 1 Press »RDS/P.SCAN« to call up the PTY function.
– Display: the current station type, e.g. »NEWS«, »PTY« flashes.
– If no station type code is transmitted, »NONE« appears in the display.
- 2 To select another station type, press »PRESET ◀◀« or »PRESET ▶▶«.

SEARCHING PROGRAM T

PTY

- 3 To start the PTY search, press »TUNING ◀◀« or »TUNING ▶▶«.
– Display: »SEARCHING PROGRAM TYPE« in ticker text, and then the station type to be searched for and »PTY«, both flashing.
– If the station type cannot be found: »TYPE NOT FOUND« appears in the display.
– If the station type is found, the frequency appears in the display and the desired station type can be heard.

Switching RDS time synchronisation on and off

Some RDS stations transmit an RDS time signal. If RDS time synchronisation is activated on the DVD Micro System (»SYNC ON«), the time is automatically updated using this new information.

SYNC OFF

- 1 To call up this function, press »RDS/P.SCAN« three times.
– Display: »SYNC OFF« or »SYNC ON«.
- 2 Press »PROGRAM« to switch RDS time synchronisation on or off.

TIMER-MODE

Your DVD Micro System has two timer modes:

- The switch-on timer which switches the DVD Micro System on and off at set times and wakes you in disc or tuner mode.
- The sleep-timer, which switches the DVD Micro System off at a time you set.

Switch-on timer

Setting the switch-on timer

Notes:

The clock on the DVD Micro System must already be set. During the setting, if no button is pushed for more than 10 seconds, the DVD Micro System ends the procedure automatically. You then have to start again.

- 1 With the system is standby, press »**TIMER**« for longer than 2 seconds and keep it held down.
 - Display: »**TIMER**« and the input source last selected, e.g. »**DISC**« or »**TUNER**«.
- 2 Select the desired input source, by pressing »**PROGRAM**« and then »**TUNING** ◀◀« or »**TUNING** ▶▶«, confirm your selection with »**PROGRAM**«.
 - Display: the volume when switching on, e.g. »**VOL 12**«.

Note:

If the tuner is selected as the switch-on input source, then select the desired channel position with »**TUNING** ◀◀« or »**TUNING** ▶▶« and conform with »**PROGRAM**«.

If disc mode is selected and no disc has been inserted, the DVD Micro System will switch on automatically in tuner mode.

- 3 Select the desired switch-on volume with »**TUNING** ◀◀« or »**TUNING** ▶▶« and confirm with »**PROGRAM**«.
 - Display: »**ON**«, the hours display flashes.
- 4 Set the hours for the switch-on time with »**TUNING** ◀◀« or »**TUNING** ▶▶« and confirm with »**PROGRAM**«.
 - Display: »**ON**«, the minutes display flashes.
- 5 Set the minutes for the switch-on time with »**TUNING** ◀◀« or »**TUNING** ▶▶« and confirm with »**PROGRAM**«.
 - Display: »**OFF**«, the hours display flashes.
- 6 Set the hours for the switch-off time with »**TUNING** ◀◀« or »**TUNING** ▶▶« and confirm with »**PROGRAM**«.
 - Display: »**OFF**«, the minutes display flashes.
- 7 Set the minutes for the switch-off time with »**TUNING** ◀◀« or »**TUNING** ▶▶« and confirm with »**PROGRAM**«.
 - Display: briefly, »**TIMER OK**«.
 - The timer settings are saved.

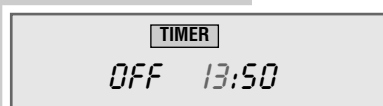
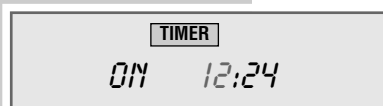

Activating and deactivating the switch-on timer

- 1 Press »TIMER« to activate.
– Display: »TIMER«.
- 2 Press »TIMER« again to deactivate.
– Display: »TIMER« disappears from the display.

Sleep timer

Setting the sleep timer

The sleep timer switches the system off at the set time.

- 1 To activate the function, press and hold down »**CLOCK/SLEEP**« on the remote control.
– Display: »SLEEP OFF«, »OFF« flashes.
- 2 To set the desired switch-off time press (»120 MIN«, »110 MIN« to »1 MIN«) »**CLOCK/SLEEP**« repeatedly.
– Display: e.g. »80 MIN«, followed by a constant display of the input source and »**SLEEP**«.
– The system switches off after the selected time.
- 3 To see the remaining time until the switch-off time, press and hold down »**CLOCK/SLEEP**« on the remote control.
– Display: e.g. »49 MIN«.

Deactivating the sleep timer

- 1 Keep pressing »**CLOCK/SLEEP**« on the remote control until »SLEEP OFF« appears in the display.
– Display: »SLEEP OFF« disappears after a short while.
– The system stays on.

or

- 1 Switch the DVD Micro System to standby with »**⏻**«.

SLEEP OFF

SLEEP

ANTENNE

SLEEP OFF

CHILD LOCK

Some DVDs may contain parental guidance warnings concerning age restrictions. The set-up menu enables you to define eight levels of age restrictions for the child lock. »1« is the default setting.

If the inserted DVD is not suitable for the defined age category according to the parental lock, then the DVD will not be played.

Changing the child lock settings

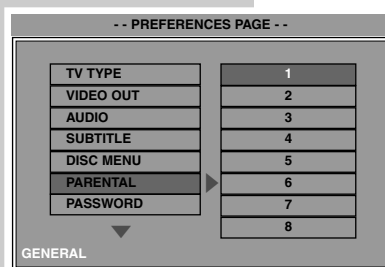

- 1 Select the »PREFERENCES« menu item with »▲« or »▼« and confirm with »DEMO/OK«.
- 2 Select »PARENTAL« with »▲« or »▼«.
- 3 Use »▶« to move to the right column.
The following settings are available »1« to »8«.
 - 1: suitable for all ages
 - 2: Level 2
 - 3 (PG): only with parental guidance
 - 4 (PG 13): not suitable for children under 13, from ages 13 to 18 only under parental guidance
 - 5: Level 5
 - 6 (PG-R): may contain violence or sex scenes, can only be viewed under 18 under with parental guidance
 - 7 (NC-17): only for adults, not for those under 17
 - 8 (ADULT): only for adults
- 4 Select the required setting by pressing »▲« or »▼« and confirm with »DEMO/OK«.
- 5 To change the setting, enter the master code »1234« with »1 ... 0« and confirm with »DEMO/OK«.

Changing the parental lock access code

You can replace the master code with your own personal access code. This personal code is needed to change the parental lock settings if you yourself wish to play a disc unsuitable for young people.

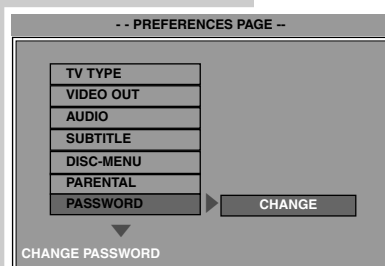

- 1 Select the »PREFERENCES« menu item with »▲« or »▼« and confirm with »DEMO/OK«.
- 2 Select »PASSWORD« by pressing »▲« or »▼«.
- 3 Use »▶« to move to the right column and confirm with »DEMO/OK«.
- 4 Enter the master code »1234« or – if you already have one the old personal code with »1 ... 0«.
- 5 Enter the new code with »1 ... 0«.
- 6 Confirm the new code by entering it again and then press »DEMO/OK«.

Note:

As the master code is independent from your personal code to access the parental lock, we advise you to keep pages 41 and 46 of this instruction manual in a place where your children cannot reach it.

ADDITIONAL SETTINGS

Like the basic settings, you can make additional settings in the set-up menu.

Setting the picture mode

This setting controls contrast and sharpness depending on the medium inserted.

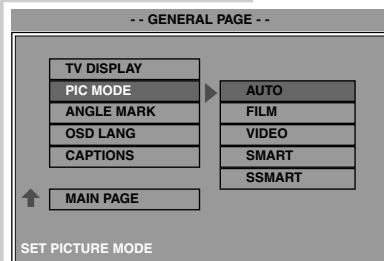

- 1 Select the »GENERAL SETUP« menu item with »▲« or »▼« and confirm with »DEMO/OK«.
- 2 Select »PIC MODE« using »▲« or »▼«.
- 3 Use »▶« to move to the right column.
The following settings are available: »AUTO«, »FILM«, »VIDEO«, »SMART« or »SSMART«.
- 4 Select the required setting by pressing »▲« or »▼« and confirm with »DEMO/OK«.

Displaying the multi-angle symbol

This function allows a scene to be played from various camera angles (multi-angle technology). The current angle and the total number of angles is displayed by the multi-angle-symbol.

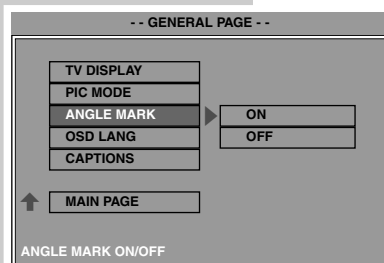

- 1 Select the »GENERAL SETUP« menu item with »▲« or »▼« and confirm with »DEMO/OK«.
- 2 Select »ANGLE MARK« by pressing »▲« or »▼«.
- 3 Use »▶« to move to the right column.
The following settings are available: »ON« or »OFF«. »OFF« is the default value.
- 4 Select the required setting by pressing »▲« or »▼« and confirm with »DEMO/OK«.

Activating and deactivating the status line

You can switch the status line on and off as required.

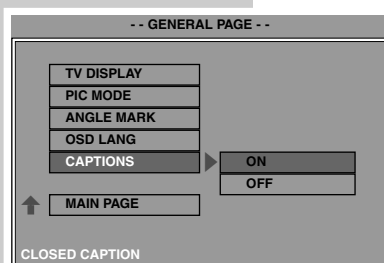

- 1 Select the »GENERAL SETUP« menu item with »▲« or »▼« and confirm with »DEMO/OK«.
- 2 Select »CAPTIONS« using »▲« or »▼«.
- 3 Use »▶« to move to the right column.
The following settings are available: »ON« or »OFF«.
- 4 Select the required setting by pressing »▲« or »▼« and confirm with »DEMO/OK«.

ADDITIONAL SETTINGS

Language settings

The preference settings in the set-up menu are not available during playback. To make these settings, playback must be ended first. The default setting is »ENGLISH«.

Setting the preferred dubbing language

- 1 Select the »PREFERENCES« menu item with »▲« or »▼« and confirm with »DEMO/OK«.
- 2 Select »AUDIO« by pressing »▲« or »▼«.
- 3 Use »▶« to move to the right column.
- 4 Select your language using »▲« or »▼« and press »DEMO/OK« to confirm.

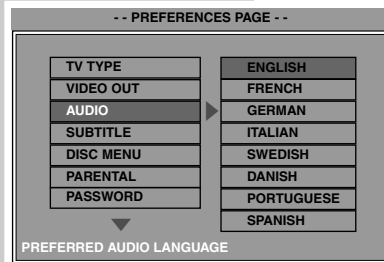

Setting the preferred subtitle language

- 1 Select the »PREFERENCES« menu item with »▲« or »▼« and confirm with »DEMO/OK«.
- 2 Select »SUBTITLE« with »▲« or »▼«.
- 3 Use »▶« to move to the right column.
- 4 Select your language using »▲« or »▼« and press »DEMO/OK« to confirm.

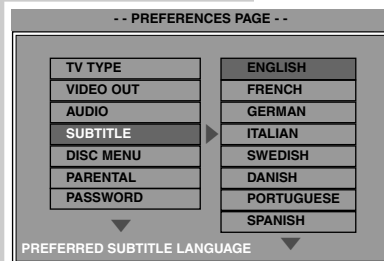

Setting the preferred disc menu language

- 1 Select the »PREFERENCES« menu item with »▲« or »▼« and confirm with »DEMO/OK«.
- 2 Select »DISC MENU« with »▲« or »▼«.
- 3 Use »▶« to move to the right column.
- 4 Select your language using »▲« or »▼« and press »DEMO/OK« to confirm.

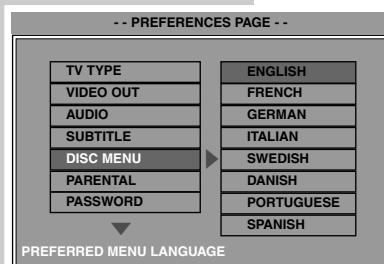



Technical data

This device is noise-suppressed according to the applicable EU directives. This product fulfils the European directives 89/336/EEC, 73/23/EEC and 93/68/EEC.

This device conforms to the safety regulation DIN EN 60065 (VDE 0860) and therefore the international safety regulation IEC 60065.

Do not open the DVD Micro System and loudspeakers. No warranty claims are accepted for damage resulting from improper handling.

Manufactured with permission from Dolby Laboratories.
"Dolby", "Pro Logic" and the double-D symbol "DD" are trademarks of Dolby Laboratories.

Technical and design modifications reserved.

General information

Mains voltage:
230V ~, 50/60 Hz

Maximum power consumption:
Operating: ≤ 60 W (DVD Micro System)
Operating: ≤ 85 W (Subwoofer)
Standby: ≤ 6 W (DVD Micro System)
Eco mode: ≤ 1 W (DVD Micro System)
Standby: ≤ 5 W (Subwoofer)

Ambient temperature:
+10°C to +35°C

Amplifier

Output:
Nominal:
5 x 30 W (5 x 8 Ω)
Music:
5 x 50 W (5 x 8 Ω)

Input sensitivity/impedance (audio analogue):
400 mV / 22 kΩ

Frequency range:
10 ... 24,000 Hz

Non-linear distortion factor:
-1 dB, 8 Ω, 1 kHz, ≤ 0.3 %

Disc unit

Playback standard:
PAL, 50 Hz, 625 lines
NTSC, 60 Hz, 525 lines

Picture format:
4:3, 16:9

Playback system:
DVD-video, video-CD 1.1 and 2.0, S-video-CD,
MP3-CD, WMA-CD, audio-CD (CD-DA)
CD-R, CD-RW, DVD-R,
CD ROM (MP3), sampling frequency 44.1 kHz

Radio

Sensitivity:
Mono (S/N=26 dB), 4 μV
Stereo (S/N=46 dB), 30 μV

Non-linear distortion factor:
Mono (1 kHz, 40 kHz dev.), 0.3 %
Stereo (1 kHz, 40 kHz dev.), 0.6 %

Frequency range:
(± 3 dB) 20 ... 14,000 Hz

Noise voltage ratio:
22.5 kHz dev., DIN A, mono, ≥ 60 dB
40 kHz dev., DIN A, stereo, ≥ 63 dB

FM and AM frequency bands:
FM 87.5 ... 108 MHz
AM 522 ... 1620 kHz

Loudspeakers

Music/rated load:

Music:
2 x 18 W (8 Ω) (front), 1 x 75 W (subwoofer)
Nominal:
2 x 12 W (8 Ω), 1 x 40 W (subwoofer)

Frequency range:

Front loudspeakers:
150 ... 20,000 Hz
Subwoofer:
40 ... 150 Hz

System:

2 x 2-way
subwoofer: Bass reflex system

Dimensions and weight

DVD Micro System

W x H x D: 152 x 157 x 260 mm
4.0 kg

Front loudspeakers

W x H x D: 160 x 270 x 200 mm
2.4 kg

Subwoofer

W x H x D: 199 x 311 x 340 mm
6.3 kg

General instructions for laser devices

Your system is a CLASS 1 LASER PRODUCT. This means that the laser is designed in such a way as to ensure that the maximum permissible emission value cannot be exceeded under any circumstances.

Caution:

If operating devices or methods other than those specified here are employed, it may lead to dangerous exposure to emissions.

This device emits laser radiation. Because of the danger of eye injuries, the unit may only be opened or serviced by trained personnel.

If settings other than those specified here are employed or OTHER PROCEDURES are carried out, this may lead to dangerous radiation exposure.

Cleaning discs

Wipe the dirty disc with a cloth from the centre outwards in a straight line. Do not use any solvents such as benzene, thinners, conventional cleaner or anti-static spray for vinyl records.

CLASS 1
LASER PRODUCT



Rectifying minor problems

Not every picture or sound problem is caused by a defect in your DVD Micro System. Defects can also be caused by leads having been accidentally pulled out, damaged discs and worn out batteries in the remote control. If the following measures do not do not rectify the problem, consult your authorised dealer.

Due to the difference in quality of the recording media and the quality of the recording itself, it can occasionally happen that a home-made disc cannot be read. This does not indicate a malfunction of the DVD Micro System.

Fault	Possible cause/remedy
The DVD Micro System cannot be switched on.	No electrical supply: Check the connection to the mains cable.
The DVD Micro System does not respond to the remote control.	Obstacles, used batteries: Remove all obstacles which could disturb the signal of the remote control. Test or replace the batteries of the remote control.
No picture or sound.	Wrong cable connection, the video or audio connection cable is faulty: Check the connections on the DVD Micro System and on the television. The MUTE function has been activated: Deactivate this function as described on page 26.
No sound or insufficient bass tone coming from the subwoofer.	The subwoofer has been connected incorrectly: Check to make sure the subwoofer has been connected properly. Switch the phase angle of the subwoofer if necessary.
The inserted disc does not play.	Make sure the printed side of the disc is facing upwards. Clean the disc. The DVD Micro System cannot read the inserted disc format. Check to see if the inserted DVD has the regional code 2. The parental lock settings prevent the playback of the disc: Alter the parental lock settings (see page 41).
Playback stop, music search, slow motion, playback repeat or programmed playback do not work.	The relevant functions are not available with the inserted disc.
No or inadequate MP3 playback.	The sampling frequency 44.1 kHz has not been observed: Burn the new MP3 CD observing the sampling frequency.
CD-Rs or CD-RWs are not being played back, or being played back incorrectly.	Faulty software or hardware settings during burning or the CD itself: Check the components of your CD burner/software or change the CD being used.
Distorted audio signal during FM reception.	Poor stereo reception: Correct the frequency manually, if necessary. Faulty antenna connection: Check the antenna connection.
You have forgotten the personal access code for the parental lock.	Enter the master code »1234«.

Free Manuals Download Website

<http://myh66.com>

<http://usermanuals.us>

<http://www.somanuals.com>

<http://www.4manuals.cc>

<http://www.manual-lib.com>

<http://www.404manual.com>

<http://www.luxmanual.com>

<http://aubethermostatmanual.com>

Golf course search by state

<http://golfingnear.com>

Email search by domain

<http://emailbydomain.com>

Auto manuals search

<http://auto.somanuals.com>

TV manuals search

<http://tv.somanuals.com>