

COLOUR TV

**Cinemo GLCD4000HD
Cinemo GLCD4600HD**

**Grundig Helpline: 1800 509 394 Australia
Grundig Helpline: 0800 450 259 New Zealand**

ENGLISH

GRUNDIG

Contents

Installation	3	Installation Menu	34-35
Remote control handset	4-5	Station search	34
Controls	4	Front Light	35
Battery installation	5	Other Menu	36
Controls of		Connection of PC	37
Front panel	6	PIP (Picture-In-Picture) Feature	38-39
Connections of		Watching PIP	38
Back panel	7	PIP Audio input	38
Connection to		Moving the PIP	39
External equipment	8-12	Sub picture size	39
Basic operation		Programme scan	39
On and Off	13	Information Menu (In Digital mode only)	40
Programme selection	13	Teletext	41-42
Volume adjustment	13	Displayable Monitor Specification	43
On screen language selection	13	Guarantee	44
On screen menus		Troubleshooting	
Menu selection	14	Check list	47
Setting up TV stations	15-26		
Sound adjustment	15-19		
Picture adjustment	20-22		
Child lock	23		
Timer	24-26		
DTV option Menu (in digital mode only)	27-30		
Preset list Menu	31-33		

Power

This set operates on an AC mains supply, the voltage is as indicated on the label on the back cover. Never apply DC power to the set. In the event of thunderstorms or power-cuts, please pull out the aerial and mains plugs.

Warning

To prevent fire or shock hazard, do not expose the set to rain or moisture. Do not rub or strike the Active Matrix LCD with anything hard as this may scratch, mar, or damage the Active Matrix LCD permanently.

Service

Never remove the back cover of the set as this can expose you to very high voltage and other hazards. If the set does not operate properly, unplug it and call your dealer.

Aerial

Connect the aerial cable to the socket marked 75Ω on the back cover. For the best reception an outdoor aerial should be used.

Location

Position your set so that no bright light or sunlight falls directly onto the screen. Care should be taken not to expose the set to any unnecessary vibration, moisture, dust or heat. Also ensure that the set is placed in a position to allow a free flow of air. Do not cover the ventilation openings on the back cover.

Cleaning

Unplug the set before cleaning the face of the LCD Screen. Dust the set by wiping the screen and the cabinet with a soft, clean cloth. If the screen requires additional cleaning, use a clean, damp cloth. Do not use liquid cleaners or aerosol cleaners.



To preserve the Environment,
do not rubbish.

Remote control handset Controls

- All the functions can be controlled with the remote control handset.
- Some functions can also be adjusted with the buttons on the front panel of the set.

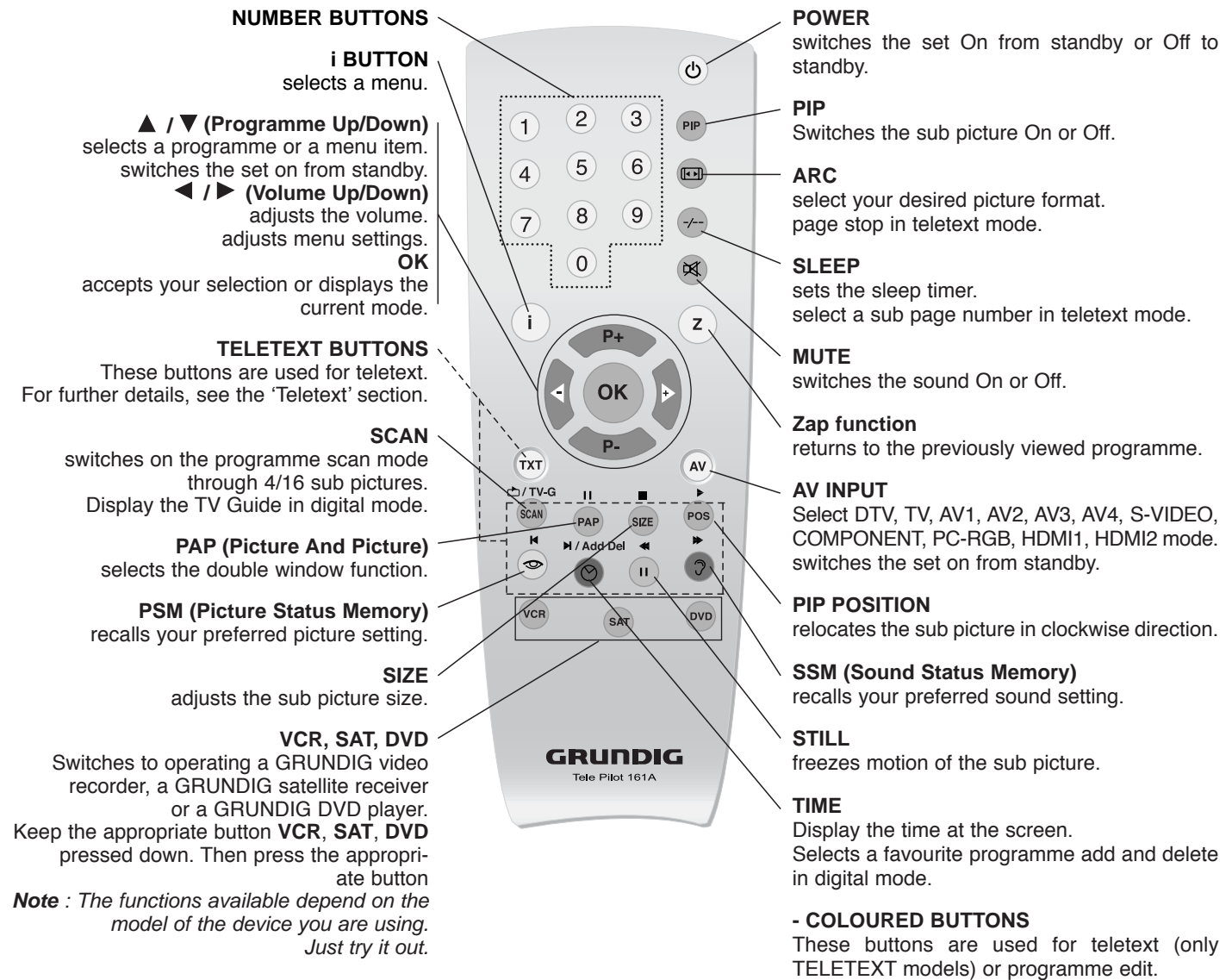

Before you use the remote control handset, please install the batteries.

Remote control handset

Battery installation

- Your remote control handset is powered by two AA type batteries.



- To insert batteries, turn the remote control handset over and remove the battery cover.
- Put the two batteries into the compartment observing battery polarity.
- Replace the cover.

To avoid damage from possible battery leakage, remove the batteries if you do not plan to use the remote control handset for an extended period time. Do not use batteries of differing age or type. Always discard of batteries safely.

Controls of Front panel

- Shown is a simplified representation of the set.
- Here shown may be somewhat different from your set.
- This manual explains the features available on the Cinemo GLCD4000HD series.

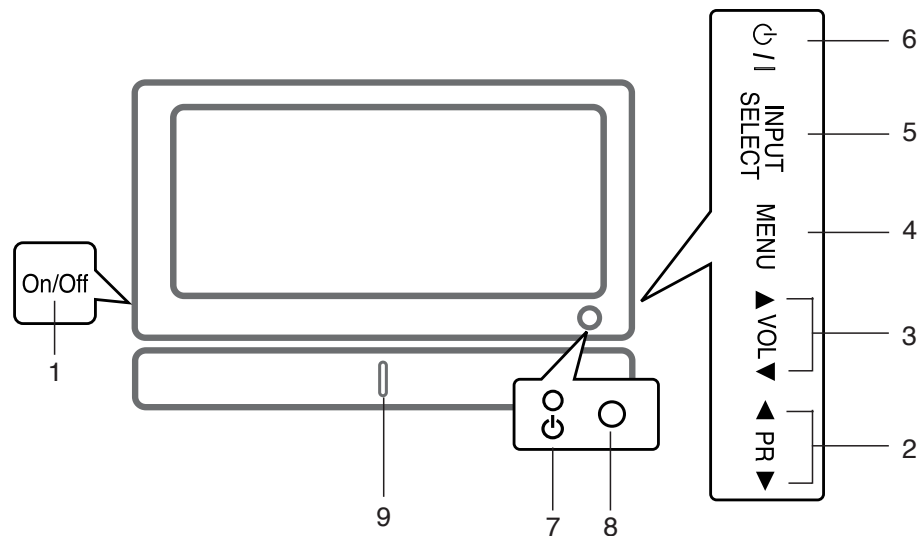

- 1. MAIN POWER**
switches the set On or Off.
- 2. ▲ / ▼ (Programme Up/Down)**
selects a programme or a menu item.
switches the set On from standby.
- 3. ◀ / ▶ (Volume Down/Up)**
adjusts the volume.
adjusts menu settings.
- 4. MENU**
selects a menu.
- 5. INPUT SELECT**
selects **DTV, TV, AV1, AV2, AV3, AV4, S-VIDEO, COMPONENT, PC-RGB, HDMI1, HDMI2** mode.
- 6. POWER (⏻)**
switches the set On from standby or On to standby.
- 7. POWER/STANDBY INDICATOR (Ⓞ)**
illuminates red in standby mode.
illuminates green when the set is switched On.
- 8. REMOTE CONTROL SENSOR**
- 9. Front Light LED**

Connections of Back panel

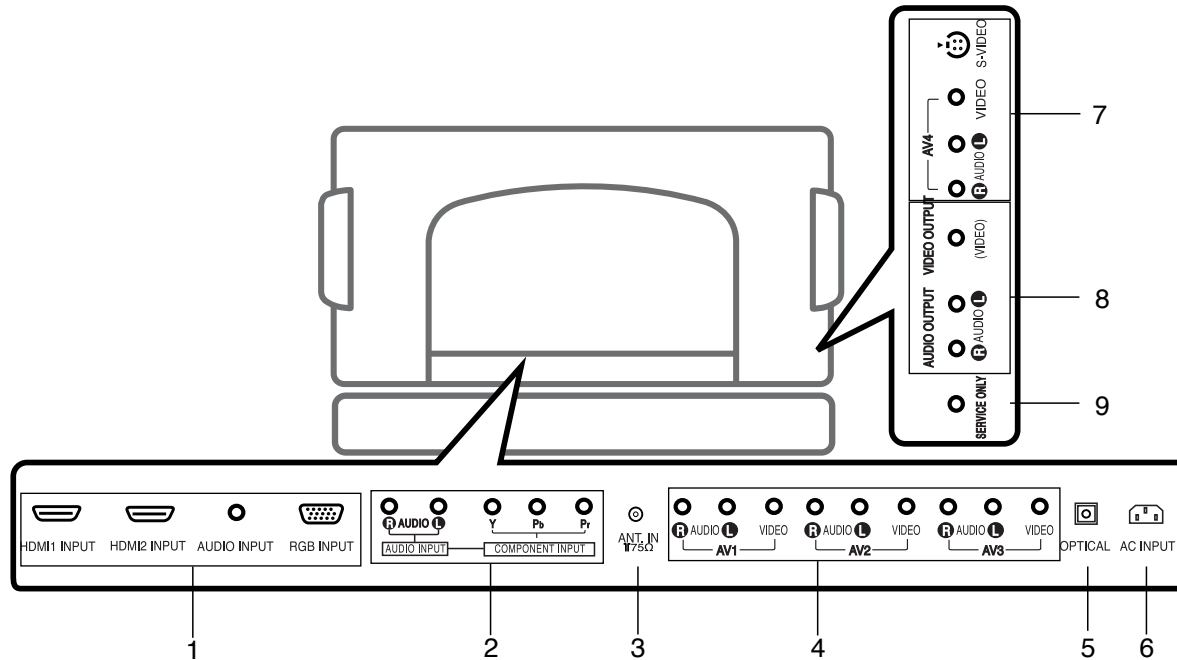

1. HDMI1 INPUT / HDMI2 INPUT / AUDIO INPUT / RGB INPUT SOCKETS

Connect the set output socket of the PERSONAL COMPUTER to this socket.

2. AUDIO INPUT / COMPONENT INPUT (480i / 480p / 576i / 576p / 720p / 1080i / 1080p) SOCKETS

3. AERIAL SOCKET

4. AUDIO / VIDEO SOCKET

Connect the audio/video out sockets of the VCR to AV sockets of the set.

5. Digital Audio (OPTICAL)

Connect digital audio from various types of equipment.

Note : In standby mode, these ports will not work.

6. POWER CORD SOCKET

This set operates on an AC power. The voltage is indicated on the Specifications page. Never attempt to operate the set on DC power.

7. AUDIO / VIDEO INPUT (AV4, S-VIDEO)

Connect video out from an S-VIDEO VCR to the S-VIDEO input.

Connect the audio/video out sockets of the VCR to AV sockets of the set.

8. AUDIO / VIDEO OUTPUT SOCKET

9. SERVICE ONLY SOCKET

Connection to External equipment

- You can connect additional equipment, such as VCRs, camcorders etc. to your set. However please check with your manufacturers instruction books for specific information. Make sure all connections are made with both your set and additional appliance unplugged from the mains to avoid damaging your equipment. Here shown may be somewhat different from your set.

1 Connect to Aerial socket

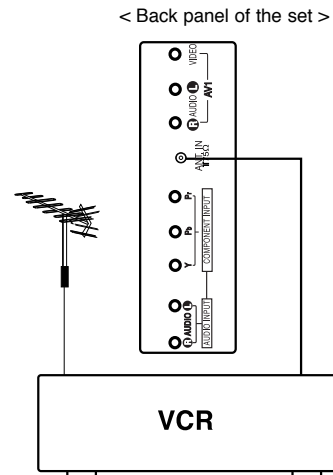

Connect the RF out socket of the VCR to the aerial socket on the back of the set.

Connect the aerial cable to the RF aerial in socket of the VCR.

Store the VCR channel on a desired programme number using the 'Manual programme tuning' section.

Select the programme number where the VCR channel is stored.

Press the **PLAY** button on the VCR.

2 Watching VCR

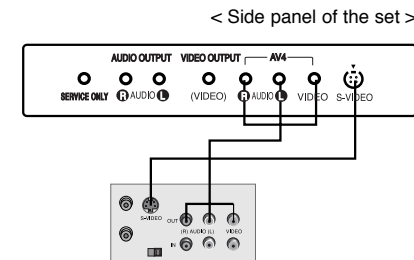

- If you connect an S-VIDEO VCR to the S-VIDEO input, the picture quality is improved; compared to connecting a regular VCR to the Video input.

- To avoid picture noise (interference), leave an adequate distance between the VCR and set.

Use the **INPUT SELECT** button on the remote control to select **AV1, AV2, AV3, AV4** or **S-VIDEO**.

(If connected to S-Video, select the **S-VIDEO** external input source.)

Insert a video tape into the VCR and press the **PLAY** button on the VCR. (See VCR owner's manual)

Connection to External equipment

3

Watching Cable TV

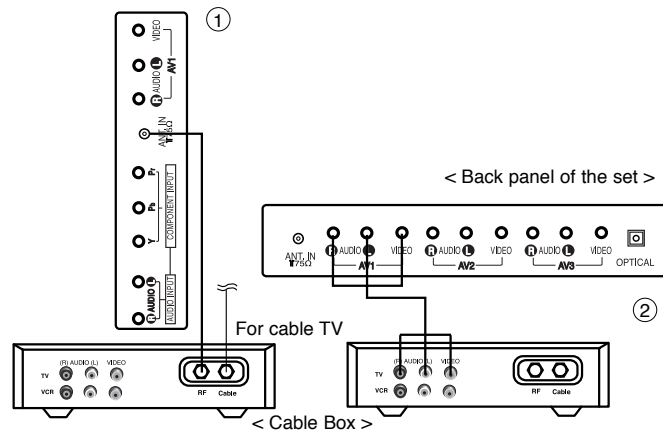

- After subscribing for a local cable TV station and installing a converter you can watch cable TV.
- For further information of cable TV, contact the local cable TV station.

In using connection 1

Select programme number in programme switch of cable box.
Match the set programme with selected programme of cable box.
Select your desired programme with the remote control for cable box.

In using connection 2

Use the **INPUT SELECT** button on the remote control and select **AV1, AV2, AV3, AV4** or **S-VIDEO**.

Tune to cable service provided channels using the cable box.

4

Watching external AV source

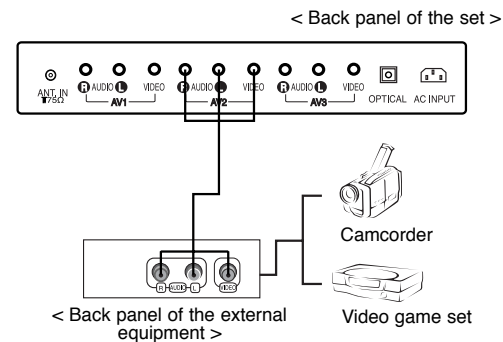

When connecting the set to an external source, match the colours of AUDIO/VIDEO input jacks on the set with the output jacks on the audio/video equipment: Video = yellow, Audio (Left) = white, Audio (Right) = red.

Use the **INPUT SELECT** button on the remote control to select **AV1, AV2, AV3, AV4** or **S-VIDEO**.

Operate the corresponding external equipment.
See external equipment operating guide.

Connection to External equipment

5 Watching DVD

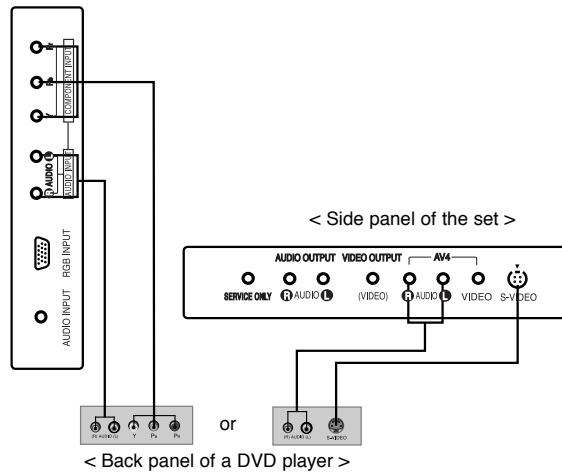

How to connect

Connect DVD video inputs to Y, PB, PR of COMPONENT (DVD INPUT) and audio inputs to Audio sockets of AUDIO INPUT.

How to use

Turn on the DVD player, and insert a DVD.

Use **INPUT SELECT** button on the remote control to select **COMPONENT**. Refer to the DVD player's manual for operating instructions.

• Component Input ports

You can get better picture quality if you connect DVD player with component input ports as below.

Component ports of the set	Y	P _B	P _R
Video output ports of DVD player	Y	P _b	P _r
	Y	B-Y	R-Y
	Y	C _b	C _r
	Y	P _B	P _R

Connection to External equipment

6

Connecting HDMI

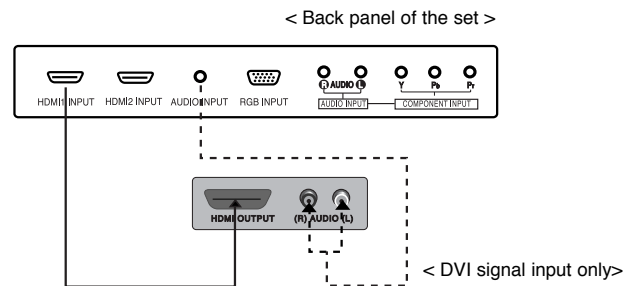

Connect the signal cable from the monitor output socket of the DVD player or Set top Box to the **HDMI INPUT** socket of the set.

Connect the audio cable from the PC to the **AUDIO INPUT** sockets of the set.

Press the **INPUT SELECT** button to select **HDMI1**, **HDMI2**.

Switch on the HDMI, and the HDMI screen appears on the set.

HDMI input signal : 480p-60Hz, 576p-50Hz, 720p-50Hz, 720p-60Hz, 1080i-50Hz, 1080i-60Hz.

HDMI Interface with HDCP Copy Protection enables all-digital rendering of video without the losses.

This TV SET can receive the High-Definition Multimedia Interface(HDMI) or Input of Digital Visual Interface(DVI).

Connection to External equipment

7 Connecting PC

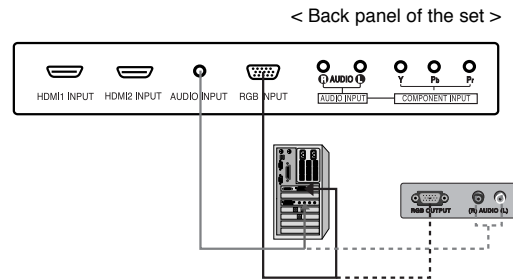

Connect the signal cable from the monitor output socket of the PERSONAL COMPUTER to the **RGB INPUT** socket of the set.

Connect the audio cable from the PC to the **AUDIO INPUT** sockets of the set.

Press the **INPUT SELECT** button to select **PC-RGB**.

Switch on the PC, and the PC screen appears on the set.

The set can be operated as the PC monitor.

RGB input signal : 480p-60Hz, 576p-50Hz, 720p-50Hz, 720p-60Hz, 1080i-50Hz, 1080i-60Hz.

8 Connecting Digital Audio

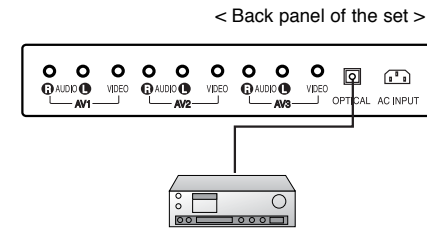

- Send the set's audio to external audio equipment (stereo system) via the Digital Audio Output (Optical)

Caution : Do not look into the optical output port. Looking at the laser beam may damage your vision.

How to connect

Connect one end of an optical cable to the TV Digital Audio (Optical) Output port.

Connect the other end of the optical cable to the digital audio (optical) input on the audio equipment.

Note : Digital Audio Output works, when it's inputted HDMI signal to the set.

1

On and Off

Press the main power button to switch the set on.

If the set is in standby mode, press the **POWER**, **▲ / ▼** buttons on the remote control handset to switch it on fully.

Press the **POWER** button on the remote control handset.

The set reverts to standby mode.

Press the main power button again to switch the set off.

2

Programme selection

You can select a programme number with the **▲ / ▼** or **NUMBER** buttons.

3

Volume adjustment

Press the **◀ / ▶** button to adjust the volume.

If you want to switch the sound off, press the **MUTE** button.

You can cancel it by pressing the **MUTE**, **◀ / ▶**, **⊗** button.

4

On screen language selection

Press the **i** button and then use **▲ / ▼** button to select the Installation menu.

Press the **OK** button and then use **▲ / ▼** button to select **Language**.

Press the **OK** button and then use **▲ / ▼** button to select your desired language.



All the on screen displays will appear in the selected language.



Press the **i** button to return to normal TV viewing.

On screen menus





Menu selection



- The dialogue between you and your set takes place on screen with an operator menu. The buttons required for the operating steps are also displayed.

1
Press the  button and then use  /  button to display each menu.

2
Press the **OK** button and then use  /  button to select a menu item.

3
Press the **OK** button to display the sub menu or the pull-down menu.

4
Change the setting of an item in the sub or pull-down menu with  /  or  / .

You can move to the higher level menu with  button and to move to the lower level menu press the  button.

Note : *Menus may vary according to input mode.*

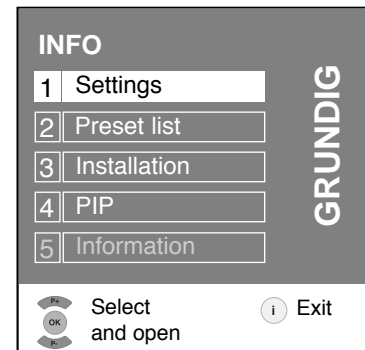

Setting up TV stations

Sound adjustment

1 Sound mode

Press the **i** button and then use **▲ / ▼** button to select the Settings menu.

Press the **OK** button and then use **▲ / ▼** button to select **Sound**.

Press the **OK** button and then use **▲ / ▼** button to select **Sound mode**.

Press the **OK** button and then use **▲ / ▼** button to select the desired sound item.

Press the **i** button to return to normal TV viewing.

Language selection for dual language broadcast

If a programme received in two languages (dual language).

DUAL A sends the primary broadcast language to the loudspeakers.

DUAL B sends the secondary broadcast language to the loudspeakers.

DUAL AB sends a separate language to each loudspeaker.

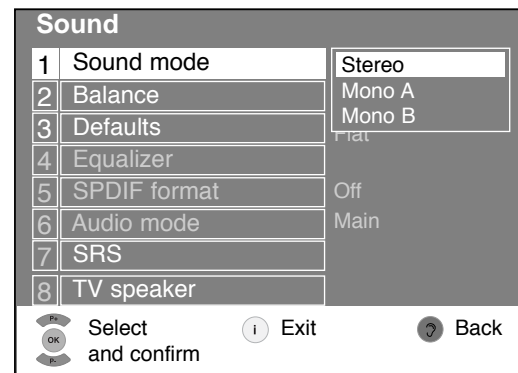
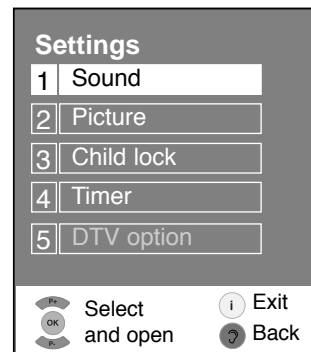
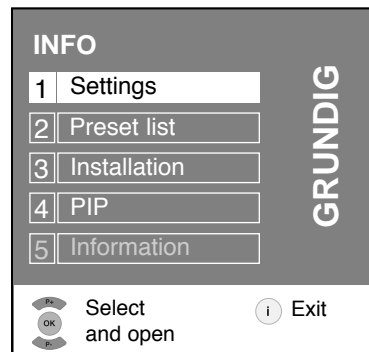

Setting up TV stations

Sound adjustment

2 Balance

Press the **i** button and then use **▲ / ▼** button to select the Settings menu.

Press the **OK** button and then use **▲ / ▼** button to select **Sound**.

Press the **OK** button and then use **▲ / ▼** button to select **Balance**.

Press the **OK** button and then use **◀ / ▶** button to make appropriate adjustments.

Press the **i** button to return to normal TV viewing.

3 Defaults

Press the **i** button and then use **▲ / ▼** button to select the Settings menu.

Press the **OK** button and then use **▲ / ▼** button to select **Sound**.

Press the **OK** button and then use **▲ / ▼** button to select **Defaults**.

Press the **OK** button and then use **▲ / ▼** button to select the desired sound item.

You can also recall a desired sound (**Flat, Music, Movie, Speech** or **User**) with **?** button on the remote control. The sound **Flat, Music, Movie** and **Speech** are programmed for good sound reproduction at the factory and cannot be changed.

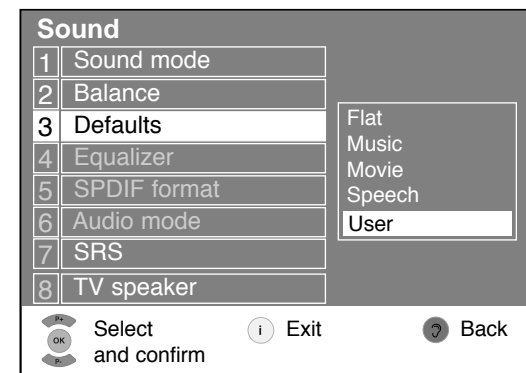
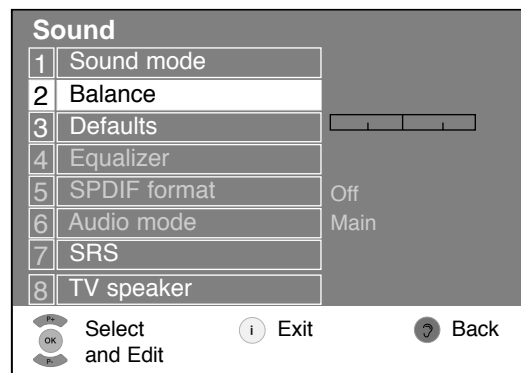

Setting up TV stations

Sound adjustment

4 Equalizer

Press the **i** button and then use **▲ / ▼** button to select the Settings menu.

Press the **OK** button and then use **▲ / ▼** button to select **Sound**.

Press the **OK** button and then use **▲ / ▼** button to select **Equalizer**.

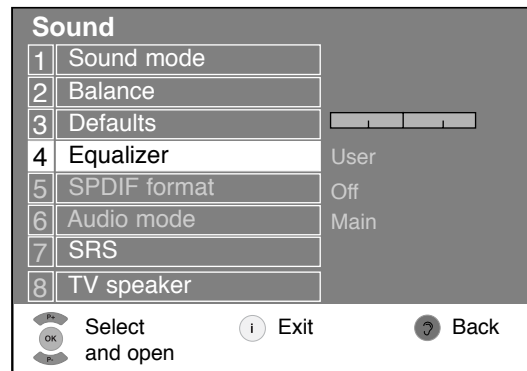

Press the **OK** button and then use **▲ / ▼** button to select the desired sound item.

Press the **OK** button and then use **◀ / ▶** button to make appropriate adjustments.

Press the **i** button to return to normal TV viewing.

Note : This function works in the User mode.

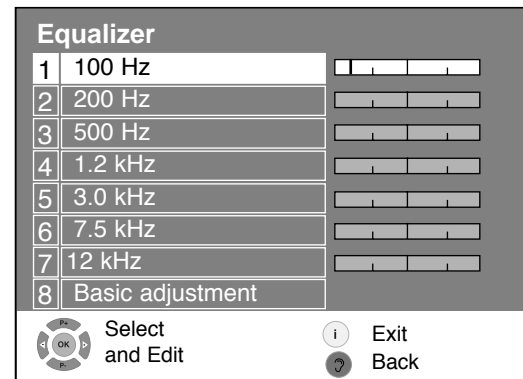

Setting up TV stations

Sound adjustment

5 SPDIF Format (in digital mode only)

Press the **i** button and then use **▲ / ▼** button to select the Settings menu.

Press the **OK** button and then use **▲ / ▼** button to select **Sound**.

Press the **OK** button and then use **▲ / ▼** button to select **SPDIF Format**.

Press the **OK** button and then use **▲ / ▼** button to select **Dolby D** or **MPEG**.

Press the **i** button to return to normal DTV viewing.

Note :

a : It's available to use **Dolby D** or **MPEG** in Dolby Digital Audio signal.

b : When it doesn't apply the Dolby Digital Audio signal, select the **MPEG** function to output the dolby digital audio by SPDIF output.

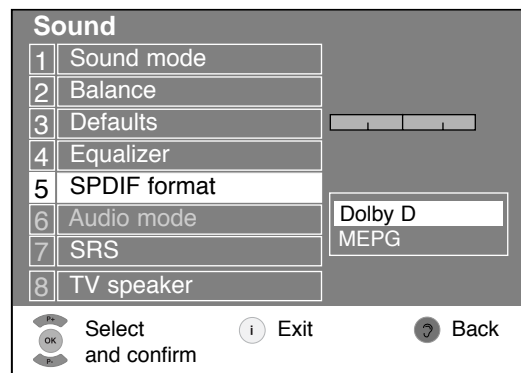

6 Audio Mode (in digital mode only)

This function lets you select your preferred sound for audio.

Press the **i** button and then use **▲ / ▼** button to select the Settings menu.

Press the **OK** button and then use **▲ / ▼** button to select **Sound**.

Press the **OK** button and then use **▲ / ▼** button to select **Audio mode**.

Press the **OK** button and then **▲ / ▼** button to select **MPEG** or **Dolby D**.

Press the **i** button to return to normal DTV viewing.

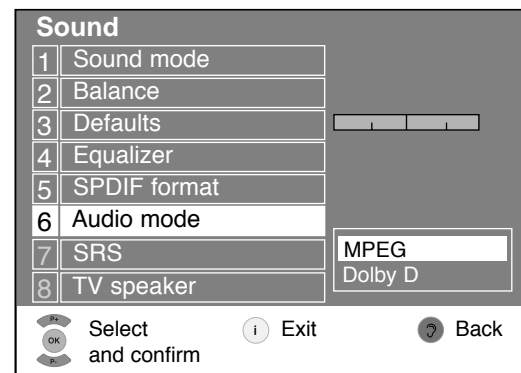

Setting up TV stations

Sound adjustment

7 SRS

SRS is a trademark of SRS Labs, Inc.
TruSurround XT
DIGITAL

- TruSurround XT technology is incorporated under license form SRS Labs, Inc.
- Manufactured under license form Dolby Laboratories.

Press the **i** button and then use **▲ / ▼** button to select the Settings menu.

Press the **OK** button and then use **▲ / ▼** button to select **SRS**.

Press the **OK** button and then use **▲ / ▼** button to select **Off**, **3D Echo sound** or **TruSurround XT**.

When selecting **Off** option in **SRS** menu, **SSM** is automatically changed **Flat**.

When selecting **3D Echo sound** or **TruSurround XT** option in **SRS** menu, **SSM** is automatically changed **User**.

Press the **i** button to return to normal DTV viewing.

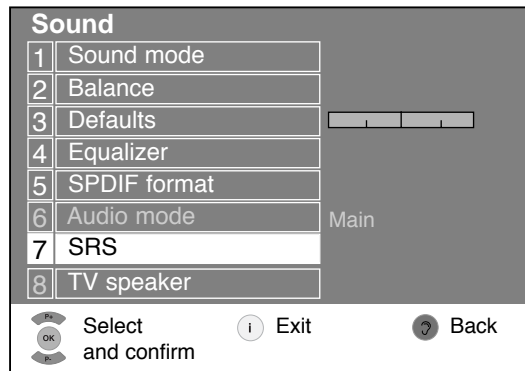

8 TV Speaker

- Turn TV speakers off if using external audio equipment.

Press the **i** button and then use **▲ / ▼** button to select the Settings menu.

Press the **OK** button and then use **▲ / ▼** button to select **TV Speaker**.

Press the **OK** button and then use **▲ / ▼** button to select **On** or **Off**.

Press the **i** button to return to normal DTV viewing.

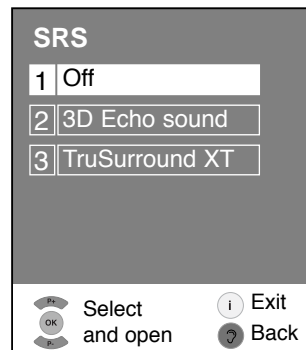

Setting up TV stations

Picture adjustment

1 Defaults

Press the **i** button and then use **▲ / ▼** button to select the Settings menu.

Press the **OK** button and then use **▲ / ▼** button to select **Picture**.

Press the **OK** button and then use **▲ / ▼** button to select **Defaults**.

Press the **OK** button and then use **▲ / ▼** button to select the desired picture option.

Press the **i** button to return to normal TV viewing.

You can also recall a desired picture (**Dynamic, Standard, Mild** or **User**) with **👁** button on the remote control. The picture **Dynamic, Standard, Mild** are programmed for good picture reproduction at the factory and cannot be changed.

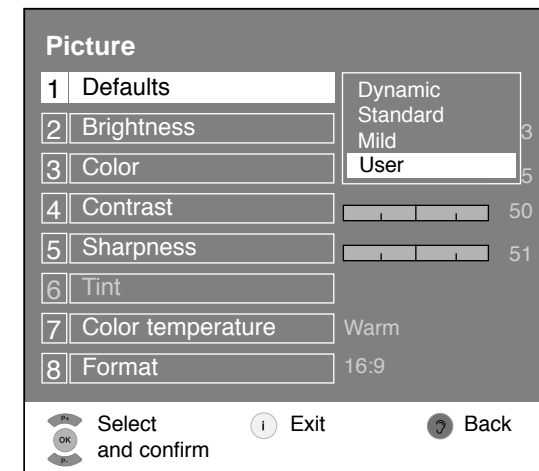
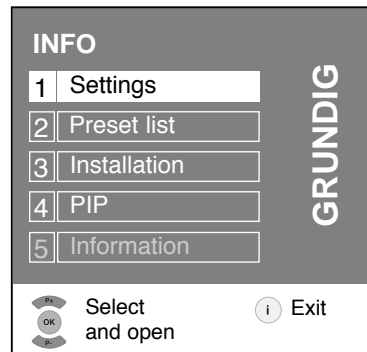

Setting up TV stations

Picture adjustment

2 Brightness

Press the **i** button and then use **▲ / ▼** button to select the Settings menu.

Press the **OK** button and then use **▲ / ▼** button to select **Picture**.

Press the **OK** button and then use **▲ / ▼** button to select the desired picture option.

Press the **OK** button and then use **◀ / ▶** button to make appropriate adjustments.

You can adjust picture contrast, brightness, color, sharpness and tint (NTSC input only) to the levels you prefer.

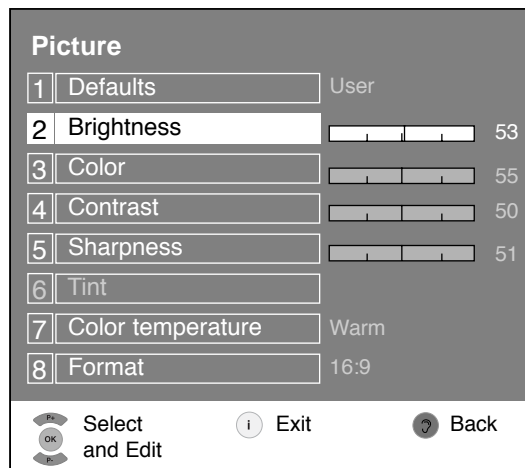

3 Color temperature

Press the **i** button and then use **▲ / ▼** button to select the Settings menu.

Press the **OK** button and then use **▲ / ▼** button to select **Picture**.

Press the **OK** button and then use **▲ / ▼** button to select **Color temperature**.

Press the **OK** button and then **▲ / ▼** button to select the desired colour temperature.

To initialize values (reset to default settings), select the **Normal** option.

Only User function ;

- Press the **▲ / ▼** button in **User**.
- Press the **▶** button and then use **▲ / ▼**, **◀ / ▶** button to make appropriate adjustments.

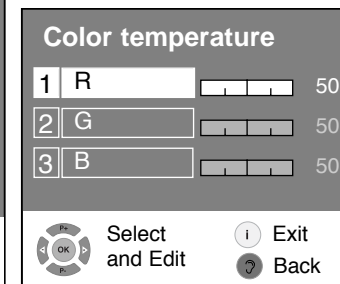
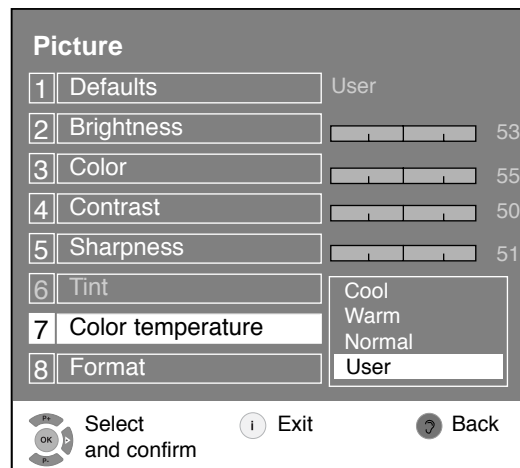

Setting up TV stations

Picture adjustment

4 Format

Press the **i** button and then use **▲ / ▼** button to select the Settings menu.

Press the **OK** button and then use **▲ / ▼** button to select **Picture**.

Press the **OK** button and then use **▲ / ▼** button to select **Format**.

Press the **OK** button and then use **▲ / ▼** button to make appropriate adjustments.



Press the **i** button to return to normal DTV viewing.

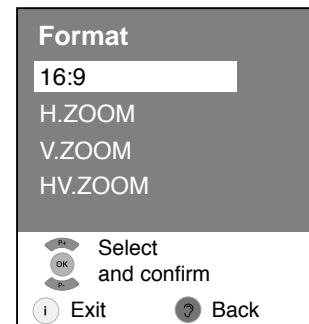
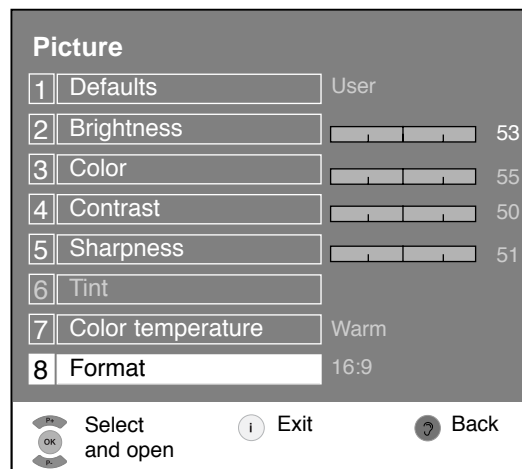
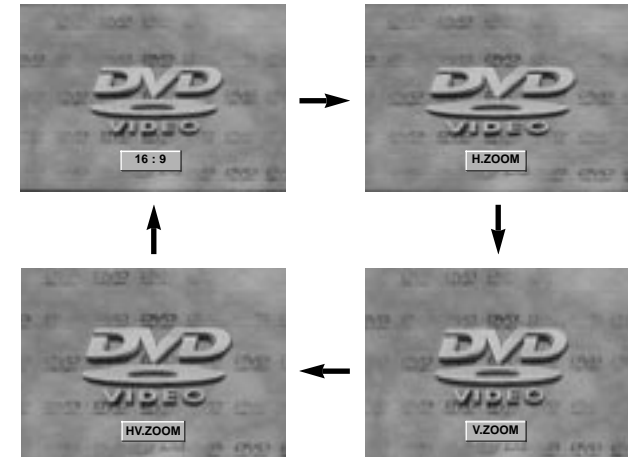

- You can only select 16:9, 14:9, 4:3, ZOOM1, ZOOM2, SPECTACLE, AUTO in TV, AV1, AV2, AV3, AV4, S-VIDEO, COMPONENT [480i/576i] mode only.
- You can only select 16:9, H.ZOOM, V.ZOOM, HV.ZOOM in DTV mode only.





Setting up TV stations Timer

1 Child lock

Press the  button and then use  /  button to select the Settings menu.

Press the **OK** button and then use  /  button to select **Child lock**.

Press the **OK** button and then use  /  button to select **Off** or **On**.

Press the  button to return to normal TV viewing.

With the lock on, the display **Child lock on** appears on the screen if any button on the front panel is pressed while viewing the TV.

Note : The display **Child lock on** will not appear on the screen if any button on the front panel is pressed while displaying the menus.

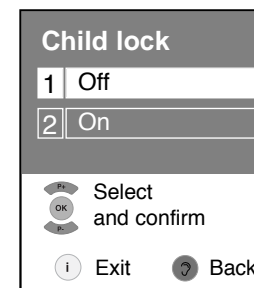
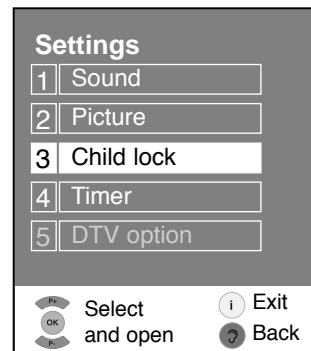
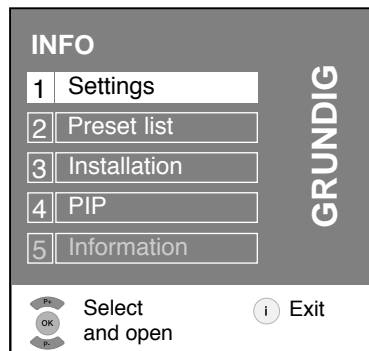





Setting up TV stations



Timer



1 Clock



- Auto time is set automatically from a digital channel signal.

Press the  button and then use  /  button to select the Settings menu.

Press the **OK** button and then use  /  button to select **Timer**.

Press the **OK** button and then use  /  button to select **Clock**.

Press the **OK** button and then use  /  button to select **Auto** or **Manual**.

Only Manual function; Press the  button and then  /  button to adjust hour and minute.

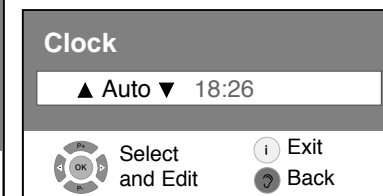
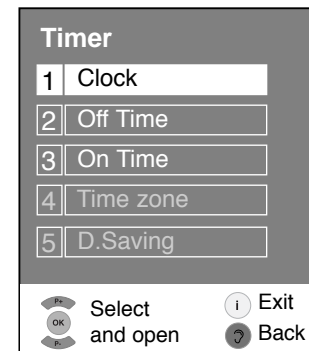
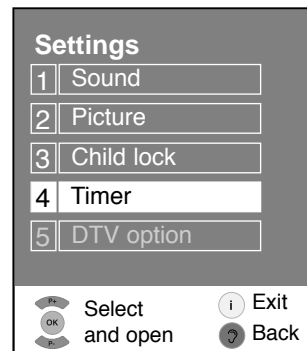
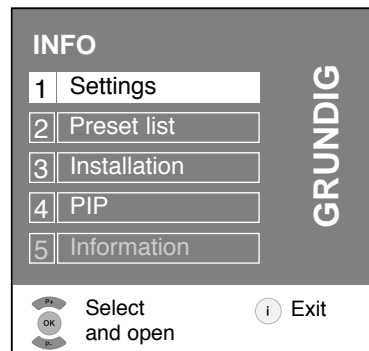

Press the  button to save.







Setting up TV stations Timer

2 On/Off Time



The off timer automatically switches the set to standby at the preset time.

Press the  button and then use  /  button to select the Settings menu.

Press the **OK** button and then use  /  button to select **Timer**.



Press the **OK** button and then use  /  button to select **Off Time** or **On Time**.

Press the **OK** button and then  /  button to select **On**.

To cancel **Off/On Time** function, press the  /  button to select **Off**.

Press the **OK** button and then  /  button to adjust the hour.

Press the  button and then  /  button to adjust the minute.

Only On time function; Press the  button and then  /  button to adjust volume level and program number.

Press the  to save.

Note :

- In the event of power interruption (disconnection or power failure), the clock must be reset.
- Two hours after the set is switched on by the on time function it will automatically switch back to standby mode unless a button has been pressed.
- Once the on or off time is set, these functions operate daily at the preset time.
- Off Timer function overrides On Timer function if they are set to the same time.
- The set must be in standby mode for the On Timer to work.

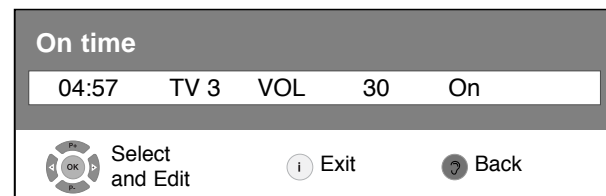
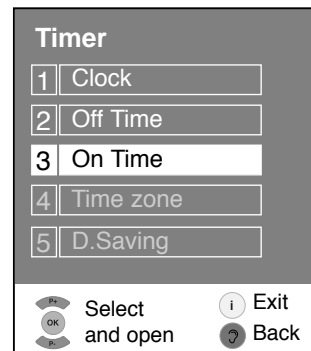
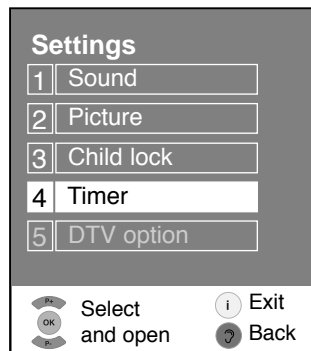

Setting up TV stations

Timer

3 Time zone (in digital mode only)

The digital channel signal includes information for the current time provided by the broadcasting station.

Press the  button and then use **▲ / ▼** button to select the Settings menu.

Press the **OK** button and then use **▲ / ▼** button to select **Timer**.

Press the **OK** button and then use **▲ / ▼** button to select **Time zone**.

Press the **OK** button and then **▲ / ▼** button to select your viewing area time zone : **NSW/ACT, VIC/TAS, QLD, SA, WA, NT, Auto time zone**.

Press the  button to return to normal DTV viewing.

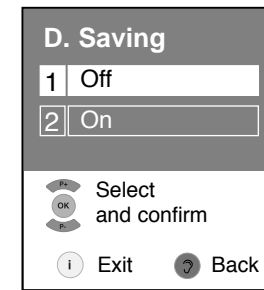
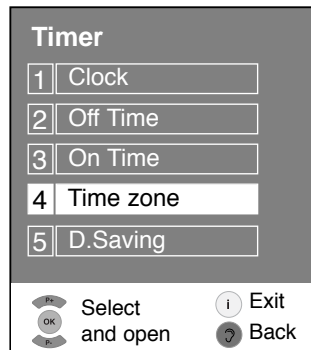

4 D. Saving (in digital mode only)

Press the  button and then use **▲ / ▼** button to select the Settings menu.

Press the **OK** button and then use **▲ / ▼** button to select **D. Saving**.

Press the **OK** button and then use **▲ / ▼** button to select **On** or **Off**.

Press the  button to return to normal DTV viewing.

DTV option Menu (in digital mode only)

1 Rating

Parental Control can be used to block specific channels, ratings and viewing sources.

Press the **i** button and then use **▲ / ▼** button to select the Settings menu.

Press the **OK** button and then use **▲ / ▼** button to select **DTV option**.

Press the **OK** button and then use **▲ / ▼** button to select **Rating**.

Press the **OK** button to enter the password as requested.

The TV is set with the initial password "0-0-0-0".

Press the **▲ / ▼** button to select type of ratings to block .

Press the **i** button to return to normal DTV viewing.

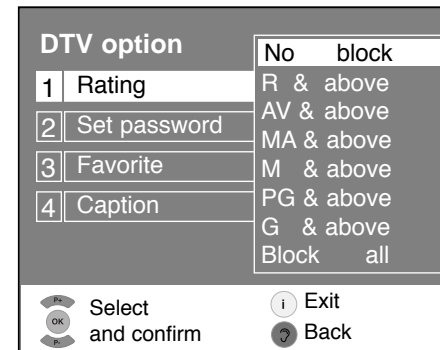
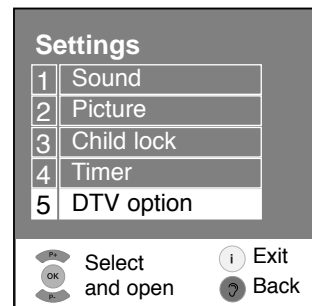
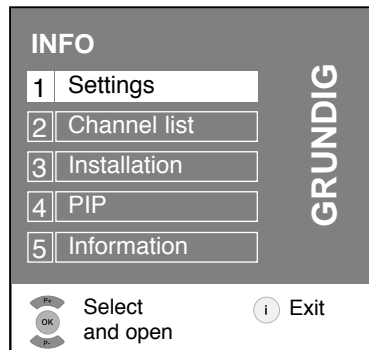

DTV option Menu (in digital mode only)

2 Rating menu option

- **No Block**
All programs can be watched because there is no age limitation.
- **R & Above (Restricted 18+)**
Programs are blocked for children under the age of 18.
- **AV & Above (Adult Audience strong violence 15+)**
This program contains the strong violent contents. Therefore, programs are blocked for children under the age of 15
- **MA & Above (Mature Adult Audience 15+)**
Programs are blocked for children under the age of 15.
- **M & Above (Mature Audience 15+)**
Programs are blocked for children under the age of 15.
- **PG & Above (Parental Guidance Recommended)**
This programs contains unsuitable materials that parents want to prevent their children from watching.
- **G & Above (General Audience)**
This programs is designed to be appropriate for all ages.
- **Block All**
All programs are blocked without considering the age level.

DTV option Menu (in digital mode only)

3 Set password

Change the password by inputting a new password twice.

Press the **i** button and then use **▲ / ▼** button to select the Settings menu.

Press the **OK** button and then use **▲ / ▼** button to select **DTV option**.

Press the **OK** button and then use **▲ / ▼** button to select **Set password**.

Press the **OK** button to enter the password as requested.

The TV is set with the initial password "0-0-0-0".

Press the **OK** button and then enter a four digit password.

Enter it again when requested.

Press the **i** button to return to normal DTV viewing.

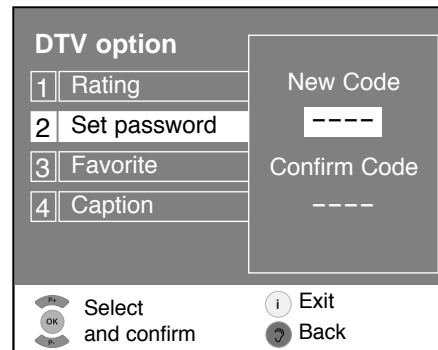
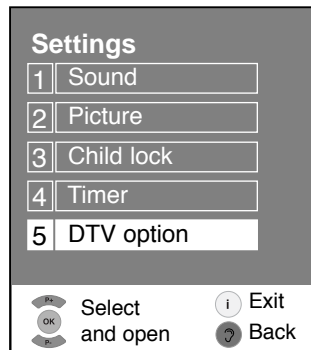

DTV option Menu (in digital mode only)

4 Favorite

This function lets you select your favourite programmes directly.

Press the **i** button and then use **▲ / ▼** button to select the Settings menu.

Press the **OK** button and then use **▲ / ▼** button to select **DTV option**.

Press the **OK** button and then use **▲ / ▼** button to select **Favorite**.

Press the **OK** button and then use **▲ / ▼** button to select **On** or **Off**.

Press the **i** button to return to normal DTV viewing.

5 Caption

Press the **i** button and then use **▲ / ▼** button to select the Settings menu.

Press the **OK** button and then use **▲ / ▼** button to select **DTV option**.

Press the **OK** button and then use **▲ / ▼** button to select **Caption**.

Press the **OK** button and then use **▲ / ▼** button to select **On** or **Off**.

Press the **i** button to return to normal DTV viewing.

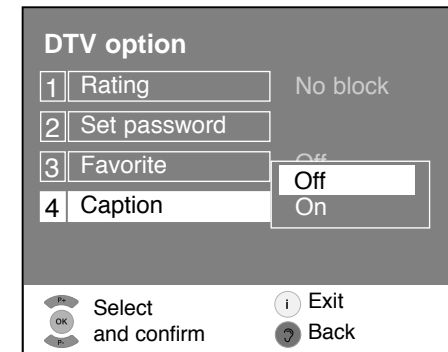
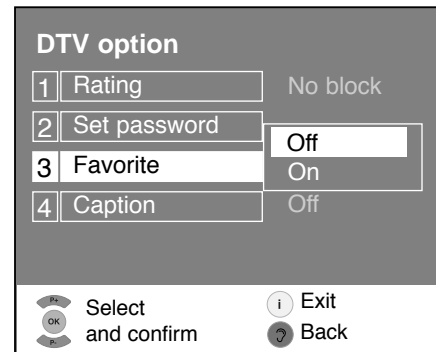
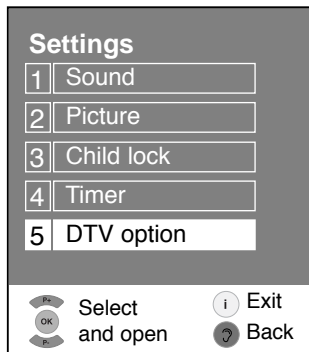

- This function enables you to delete or skip the stored programmes. Also you can move some stations to other programme numbers or insert a blank station data into the selected programme number.

Press the  button and then use **▲ / ▼** button to select the Preset list menu.

Press the **OK** button to display the **Preset list** menu.

Deleting a programme

Select a programme to be deleted with the **▲ / ▼** or **◀ / ▶** button.

Press the  button twice. The selected programme is deleted, all the following programmes are shifted up one position.

Moving a programme

Select a programme to be moved with the **▲ / ▼** or **◀ / ▶** button.

Press the  button.

Move the programme to the desired programme number with the **▲ / ▼** or **◀ / ▶** button.

Press the  button again to release this function.

< Analogue mode edit >

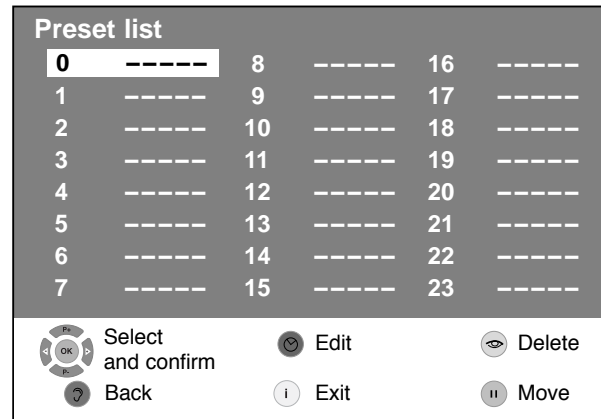
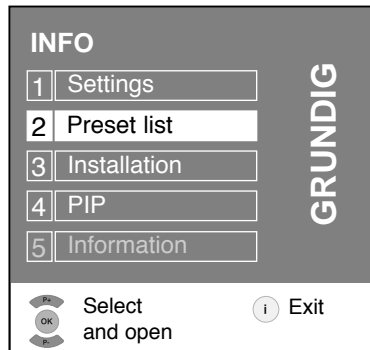

Preset list Menu

1

Select a programme to be deleted with the ▲ / ▼ or ◀ / ▶ button.

Press the Ⓞ button to display the **Edit channel settings** menu.

2

Press the ▲ / ▼ button to select **Edit name**.

Press the **OK** button.

Press the ▲ button. You can use a blank, +, -, the numeric **0** to **9** and the alphabet **A** to **Z**.

With the ▼ button you can select in the opposite direction.

Select the position by pressing the ◀ / ▶ button and then take your choice of the second character, and so on.

Press the ▲ / ▼ button to select **Type**.

Press the **OK** button and then ▲ / ▼ button to select **V/UHF** or **CABLE**.

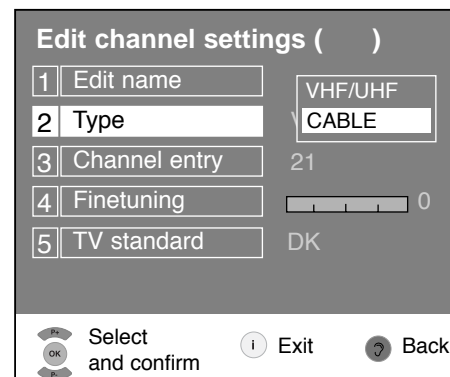
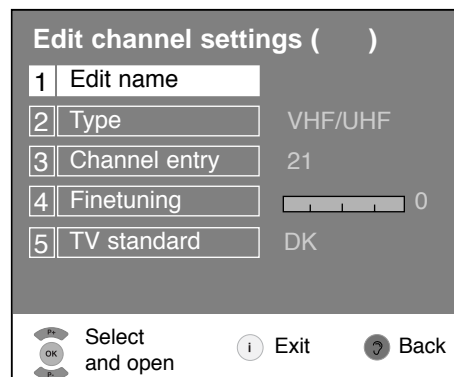

Preset list Menu

3

Normally fine tuning is only necessary if reception is poor.

Press the ▲ / ▼ button to select **Finetuning**.

Press the **OK** button.

Press the ◀ / ▶ button to fine tune for the best picture and sound.

Edit channel settings ()

1 Edit name

2 Type VHF/UHF

3 Channel entry 21

4 **Finetuning** 0

5 TV standard DK

Select and Edit Exit Back

4

Press the ▲ / ▼ button to select **TV standard**.

Press the **OK** button and then use ▲ / ▼ button to select **BG, I, DK, M**.

Edit channel settings ()

1 Edit name

2 Type VHF/UHF

3 Channel entry 21

4 Finetuning

5 **TV standard**

BG
I
DK
M

Select and confirm Exit Back

Installation Menu

- Stations can be tuned using automatic or manual modes.
- All stations that can be received are stored by this method. It is recommended that you use auto programme during installation of this set.

1 Station search

Press the **i** button and then use **▲ / ▼** button to select the Installation menu.

Press the **OK** button and then use **▲ / ▼** button to select **Station search**.

Press the **OK** button and then use **▲ / ▼** button to select **TV search, DTV search, All search**.

Press the **OK** button.

Press the **OK** button to begin auto programming.

Press the **OK** button to begin auto programming. All receivable stations are stored.

To stop auto programming, press the **i** button. When auto programming is completed, the **Preset list** menu appears on the screen. See the 'Preset list' section to edit the stored programme.

Press the **i** button to return to normal TV viewing.

Note : The auto search operation all data is deleted.

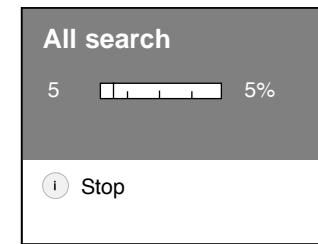
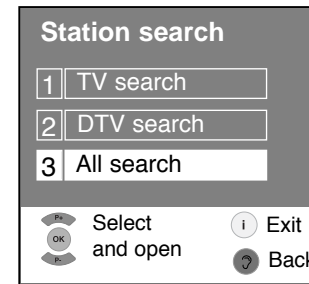
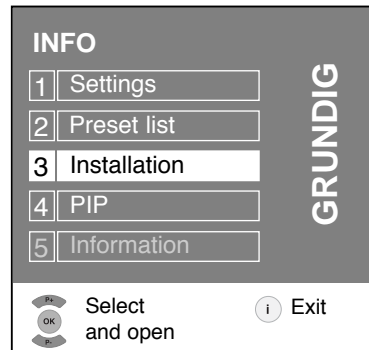

2 Front Light

You can switch Front Light LED on or off.

Press the  button and then use ▲ / ▼ button to select the Installation menu.

Press the **OK** button and then use ▲ / ▼ button to select **Front Light**.

Press the **OK** button and then use ▲ / ▼ button to select **Light On, Light Off**.

Press the **OK** button.

Press the **OK** button to begin auto programming.

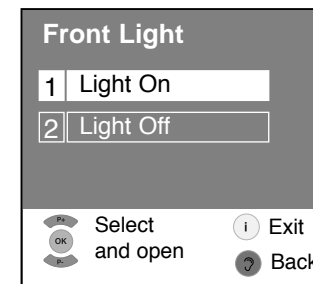
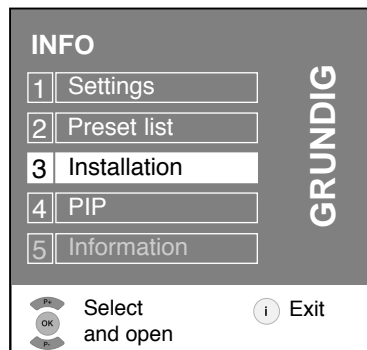

Sleep timer



You don't have to remember to switch the set off before you go to sleep. The sleep timer automatically switches the set to standby after the preset time has elapsed. Press the **-/--** button to select the number of minutes. The display '**---min**' will appear on the screen, followed by **10, 20, 30, 60, 90, 120, 180** and **240**. The timer begins to count down from the number of minutes selected.



Note :



- a. To view the remaining sleep time, press the **-/--** button once.
- b. To cancel the sleep time, repeatedly press the **-/--** button until the display '**---min**' appears.
- c. When you switch the set off, the set releases the preset sleep time.



PC Setup

You can adjust horizontal/vertical position, clock, phase, and auto-configure, reset as you prefer.

Press the  button and then use  /  button to select the Installation menu.

Press the **OK** button and then use  /  button to select **PC Control**.

Press the **OK** button and then  /  button to select the desired picture item.

Press the  /  button to make appropriate adjustments.

H-Position / V-Position

This function is to adjust picture to left/right and up/down as you prefer.

Clock

This function is to minimize any vertical bars or stripes visible on the screen background. And the horizontal screen size will also change.

Phase

This function allows you to remove any horizontal noise and clear or sharpen the image of characters.

Auto-configure

This function is for the automatic adjustment of the screen position, clock and phase. The displayed image will disappear for a few seconds while the Auto-configuration is in progress.

Reset

This function allows you to return to the good picture reproduction programmed at the factory and cannot be changed.

Note : Some signal from some graphics boards may not function properly. If the results are unsatisfactory, adjust your monitor's position, clock and phase manually.

Press the **OK** button to store it for the PC monitor picture. Press the  button to return to PC mode.

WXGA or VGA (Only RGB mode)

a : When the set is inputted WXGA signal, select the desired WXGA resolution.

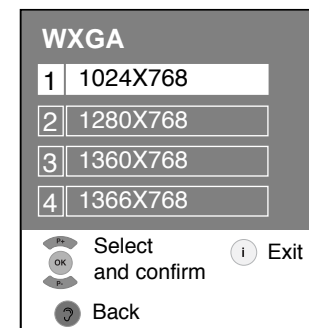
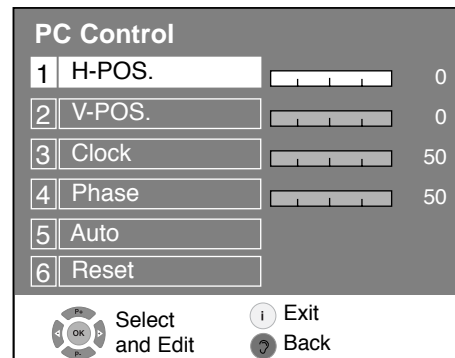

PIP (Picture-in-Picture) Feature

- PIP lets you view 2 different inputs (sources) on your monitor screen at the same time. One source will be large, and the other source will show a smaller inset image.

1

Watching PIP

Press the **PIP** button to show the sub picture.

- Each press of **PIP** button changes the screen display as shown below.

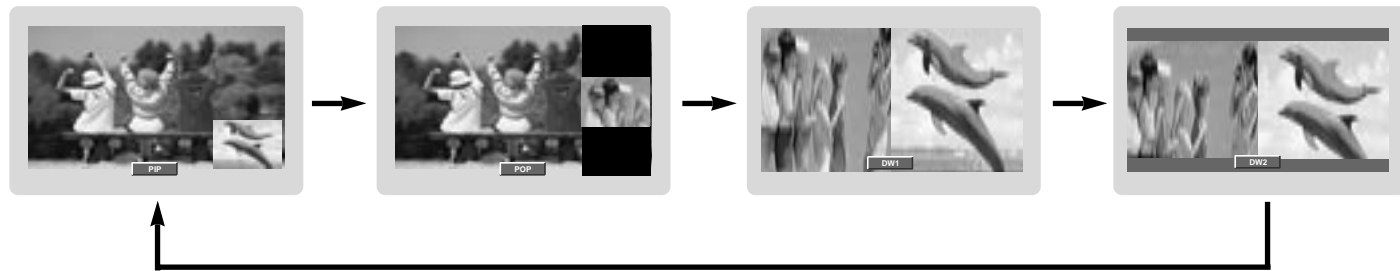

MAIN \ SUB	DTV	TV	AV1	AV2	AV3	AV4	S-VIDEO	COMP.	PC-RGB	HDMI1	HDMI2
TV	O	X	O	O	O	O	O	O	O	O	O
AV1	O	O	X	O	O	O	O	O	O	O	O
AV2	O	O	O	X	O	O	O	O	O	O	O
AV3	O	O	O	O	X	O	O	O	O	O	O
AV4	O	O	O	O	O	X	O	O	O	O	O
S-VIDEO	O	O	O	O	O	O	X	O	O	O	O

PIP (Picture-in-Picture) Feature

2

PIP Audio Input

PIP mode - main and sub picture audio select.

Press the **i** button and then **▲ / ▼** button to select the PIP menu.

Press the **OK** button and then **▲ / ▼** button to select **Audio Input**.

Press the **OK** button and then **▲ / ▼** button to select **Main** or **Sub**.

Press the **i** button to return to normal TV viewing.

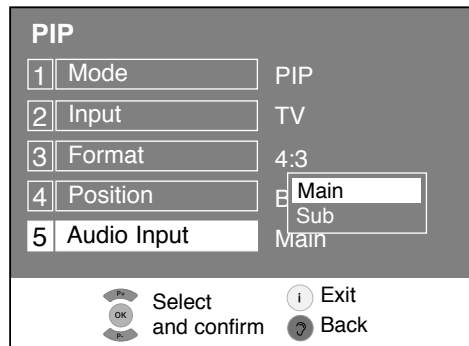

3 Moving the PIP

Press the **POS** button.

Press the **POS** button repeatedly until desired position is achieved. The sub pictures move clockwise.



4

Sub picture size

Press the **SIZE** button to select the desired sub picture size.

The sub picture appears as 1/9 size of the main picture, followed by 1/16.



Information Menu (In Digital mode only)

1 Information

- This function shows the present screen information.

Press the **i** button and then **▲ / ▼** button to select the Information menu.

Press the **OK** button and then **▲ / ▼** button to select **Information**.

Press the **OK** button.

The service information appears on screen.

Press the **i** button to return to normal DTV viewing.

Note :

a When you press the **OK** button, **Signal Strength** aren't displayed on the information OSD.

b It's disappeared after a while.

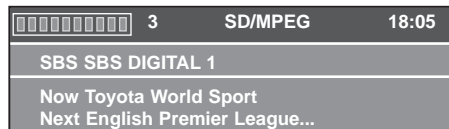

2 TV Guide

- This function shows the interactive programme guide.

Press the **i** button and then **▲ / ▼** button to select the Information menu.

Press the **OK** button and then **▲ / ▼** button to select **Information**.

Press the **OK** button.

The TV Guide information appears on screen.

Press the **i** button to return to normal DTV viewing.

Press the **SCAN** button to display the DTV Guide.

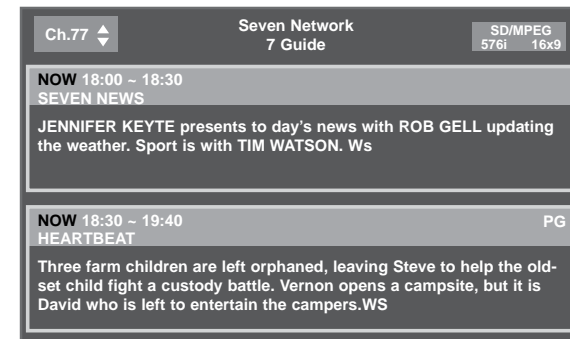

Teletext (or TOP text) is an optional function, therefore only a set with the teletext system can receive the teletext broadcast.

Teletext is a free service broadcast by most TV stations which gives up-to-the-minute information on news, weather, television programmes, share prices and many other topics.

The teletext decoder of this TV can support the SIMPLE, TOP and FASTEXT systems. SIMPLE (standard teletext) consists of a number of pages which are selected by directly entering the corresponding page number. TOP and FASTEXT are more modern methods allowing quick and easy selection of teletext information.

Switch on/off

Press the **TEXT** button to switch to teletext.

The initial page or last page appears on the screen.

Two page numbers, TV station name, date and time are displayed on the screen headline. The first page number indicates your selection, while the second shows the current page displayed.

Press the **TEXT** button to switch off teletext. The previous mode reappears.

SIMPLE text

Page selection

1. Enter the desired page number as a three digit number with the **NUMBER** buttons. If during selection you press a wrong number, you must complete the three digit number and then re-enter the correct page number.
2. The **▲ / ▼** button can be used to select the preceding or following page.

Programming a colour button in LIST mode

If the TV is in SIMPLE text, TOP text or FASTEXT mode, **POS** press the button to switch to LIST mode.

Four teletext page numbers of your choice can be colour coded and easily selected by pressing the corresponding coloured button on the remote control handset.

1. Press a coloured button.
2. Using the **NUMBER** buttons, select the page you wish to programme.
3. Press the **OK** button. The selected page is stored as the selected page number, blinking once to confirm this. From now on, you can select this page with the same coloured button.
4. The three other coloured buttons are programmed in this way.

TOP text (option)

The user guide displays four fields-red, green, yellow and blue at the bottom of the screen. The yellow field denotes the next group and the blue field indicates the next block.

Block / group / page selection

1. With the blue button you can progress from block to block.
2. Use the yellow button to proceed to the next group with automatic overflow to the next block.
3. With the green button you can proceed to the next existing page with automatic overflow to the next group.
Alternatively the ▲ button can be used.
4. The red button permits to return to previous selection.
Alternatively the ▼ button can be used.

Direct page selection

Corresponding to the SIMPLE teletext mode, you can select a page by entering it as a three digit number using the NUMBER buttons in TOP mode.

FASTEXT

The teletext pages are colour coded along the bottom of the screen and are selected by pressing the corresponding coloured button.

Special teletext functions

SCAN

Press this button to display concealed information, such as solutions of riddles or puzzles.
Press this button again to remove the information from the display.

SIZE

Selects double height text.

Press this button to enlarge the top half of the page.

Press this button again to enlarge the bottom half of the page.

Press this button again to return to the normal display.



Stops the automatic page change which will occur if a teletext page consists of 2 or more sub pages. The number of sub pages and the sub page displayed is, usually, shown on the screen below the time. When this button is pressed the stop symbol is displayed at the top left-hand corner of the screen and the automatic page change is inhibited.

To continue press this button again.

PAP

Displays the teletext pages superimposed on the TV picture.

To switch the TV picture off press this button again.

-/--

In the teletext mode, press this button to select a sub page number. The sub page number is displayed at the bottom of the screen. To hold or change the sub page, press the RED / GREEN, ▲ / ▼ or NUMBER buttons.

Press this button again to exit this function.

Displayable Monitor Specification

RGB Mode / HDMI Mode

MODE	Resolution	Horizontal Frequency (KHz)	Vertical Frequency (Hz)
DOS	640X350	31.5	70.0
	720X400	31.5	70.0
VGA		640X480	37.9
	31.5		60.0
	37.8		72.0
	37.5		75.0
SVGA	800X600	43.2	85.0
		35.1	56.0
		37.9	60.0
		48.0	72.0
		46.9	75.0
XGA	1024X768	53.7	85.0
		48.4	60.0
		56.4	70.0
		60.0	75.0
SXGA	1280X1024	60.0	85.0
		63.9	60.0
		75.0	70.0
		79.9	75.0
WXGA	1280X768	91.1	85.0
		47.7	60.0
	1360X768	60.1	75.0
		68.5	85.0
UXGA	1366X768	49.0	60.0
	1600X1200	49.0	60.0

(Synchronization input form : separate)

Note:

- If the set is cold, there may be a small "flicker" when the set is switched on. This is normal, there is nothing wrong with the set.
- If possible, use the VESA 1,024x768@60Hz video mode to obtain the best image quality for your LCD monitor. If used to PC vertical frequency 85Hz, some noise can be seen when PIP is on. In this case, set the PC vertical frequency to 60Hz. The set has been pre-adjusted to the mode VESA 1,024x768@60Hz.
- Some dot defects may appear on the screen, like Red, Green or Blue spots. However, this will have no impact or effect on the monitor performance.
- Do not press the LCD screen with your finger for a long time as this may produce some temporary distortion effects on the screen.
- When the PC screen appears on the set, a message may appear on the screen, and the message will differ according to the Window system version (Win98, 2000). If a message appears click "Next" until the message finishes.
- If the message "**Out Of Range**" appears on the screen, adjust the PC as in the 'Displayable Monitor Specification' section.

Guarantee

GUARANTEE

Please keep your receipt as proof of purchase. This product is warranted for any defect in materials or workmanship for three years after the original date of purchase. This product is for normal domestic and office use only. This warranty does not cover damage from misuse or neglect, accidental damage, vermin infestation, excessive voltages such as lightning or power surges or any alteration that affects the performance or reliability of the product.

If guarantee is required please contact the **Grundig Helpline 1800 509 394 within Australia or 0800 450 259 within New Zealand**. Have your receipt of purchase on hand.

This guarantee is subject to the following provisions :

- It is only valid within boundaries of the country of purchase;
- The product must be correctly assembled and operated in accordance with the instructions contained in this manual;
- This product must be used solely for domestic purposes;
- The guarantee does not cover accidental damage;
- The guarantee will be rendered invalid if the product is resold or has been damaged by inexpert repair;
- The manufacturer disclaims any liability for incidental or consequential damaged.

This guarantee is in addition to, and does not diminish, your statutory or legal rights.

Note

EN

Note

Troubleshooting Check list

Symptoms

- No picture, no sound
- Sound OK, poor picture
- Picture OK, poor sound
- Picture blurred
- Lines or streaks in picture
- Poor reception on some channels
- No colour
- Poor colour
- Remote control does not work
- Incorrect position
- Vertical bars or stripes on background
- Horizontal noise
- Signal Cable message appears

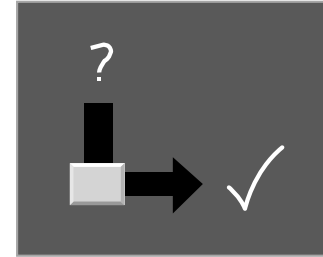

Check these items and try to adjust these

- The mains plug-(plugged in and switched on)
- Is the TV switched on
- Try another channel (weak signal)
- Check aerial (plugged into TV?)
- Check aerial (broken lead?)
- Check aerial
- Check for local interference
- Adjust contrast
- Adjust brightness
- Adjust colour
- Adjust volume
- Check the batteries in remote control
- Check Audio/Video sockets (VCR only)
- Auto-configure or adjust the H/V position
- Auto-configure or adjust Clock
- Auto-configure or adjust Clock Phase
- Is the Signal Cable connected or loose

P/NO : MAN07GDP109
(GPN07MA030A, GRUNDIG)

PO BOX 6287
Silverwater NSW 1811
<http://www.grundig.net.au>
Grundig Helpline: 1800 509 394 Australia
Grundig Helpline: 0800 450 259 New Zealand

Free Manuals Download Website

<http://myh66.com>

<http://usermanuals.us>

<http://www.somanuals.com>

<http://www.4manuals.cc>

<http://www.manual-lib.com>

<http://www.404manual.com>

<http://www.luxmanual.com>

<http://aubethermostatmanual.com>

Golf course search by state

<http://golfingnear.com>

Email search by domain

<http://emailbydomain.com>

Auto manuals search

<http://auto.somanuals.com>

TV manuals search

<http://tv.somanuals.com>