

HRF-518W  
HRF-551FR/A  
Household Frost Free Refrigerator



**Table of Contents**

**Before using the appliance**

Primary features-----Inside front cover  
Diagram of parts-----1  
Safety precautions-----2~4  
Location-----5  
Preparation -----6  
Operation-----7

**Instructions for refrigerator storage**

Refrigerating storage compartment-----8  
Refrigerating storage precautions-----9  
Suggestions-----10

**Instructions for freezing storage**

Freezing storage compartment-----11  
Freezing storage precautions-----12

**Defrosting, cleaning and vacation**

Defrosting-----13  
Cleaning -----13  
Vacation-----14~15

**Troubleshooting and after-sales service**

Troubleshooting-----16~18  
After-sales service -----19~20



\* S M S O 2 0 1 \*

- \* Please read this operation manual carefully before using the appliance.
- \* Keep this manual in a safe place.
- \* Appearance, color and layout of the door may vary.

## Primary features

### 1. Efficient ice making

A semi-automatic icemaker is installed in the freezer compartment and ice cubes can be made efficiently.

### 2. Unique chiller compartment design

A chiller drawer is on the top of the refrigerator compartment.

### 3. Automatic defrosting

This appliance features air-cooling system for automatic defrosting.

### 4. Unique external layout

External layout of the refrigerator features rounded doors and streamline treatment.

### 5. Built-in cooling system

Clear back design with built-in condenser and compressor.

### 6. Multiple venting system for efficient cooling achievements

Multiple vents are designed in the air circulation channels for efficient distribution of coldness in each compartment.

### 7. Separate control for refrigerating and freezing storage

The refrigerating and freezing compartments are controlled separately to optimize cooling efficiency and economic operation.

## After-sales service

Please determine the cause of the problem before making any repair.

### Strange odor

- \* Failure to seal food properly
- \* Rotting food inside refrigerator
- \* Failure of regular cleaning of the refrigerator



### Prolonged operation period of the compressor

- \* Initial operation
- \* Large quantity of food loaded
- \* Hot weather
- \* Frequent opening of the refrigerator door
- \* Door not properly closed
- \* Improper setting of thermostat (see the section "Operation")
- \* Poor ventilation

## Diagram of parts

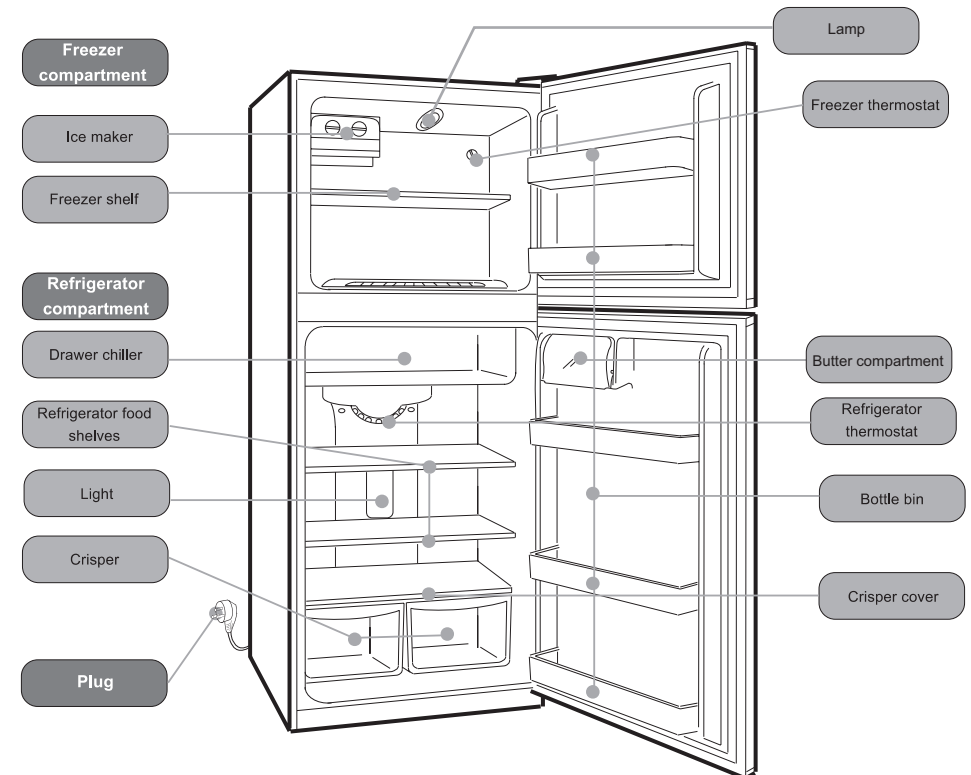

- WARNING** The plug should be accessible after the appliance positioned.  
If the supply cord is damaged; it must be replaced by the manufacture or its service agent or a similar qualified person in order to avoid a hazard.
- WARNING** The appliance is not intended for use by young children or infirm persons without supervision.
- WARNING** Young children should be supervised to ensure that they do not play with the appliance.
- WARNING** Keep ventilation openings in the appliance enclosure or in the built-in structure; clear of obstruction.
- WARNING** Do not use mechanical devices or other means to accelerate the defrosting process, other than those recommended by the manufacturer.
- WARNING** Do not damage the refrigerant circuit--(applicable only for appliances with refrigeration circuits which are accessible to the user).
- WARNING** Do not use electrical appliances inside the food storage compartments, unless they are of the type recommended by the manufacturer.

## Safety precautions

**This refrigerator requires a 200-240V/50Hz supply**  
Failure in operation and damage to the control panel, thermostat or the compressor will occur if voltage is outside the range 187-242V unless a regulator with a capacity of over 750W or higher is installed.

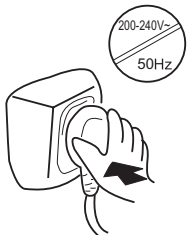

**A separate earthed socket is required.**

The refrigerator is supplied with a standard three-pin plug, of which the one for grounding should never be removed. Plug of installed refrigerator shall be always accessible.

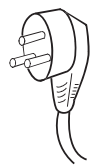

**Care for external cable**

- \* Hold the plug, not the electric cable, when unplugging the refrigerator.
- \* Ensure that the electric cable is not trapped by the refrigerator. Do not step on the cable.
- \* Avoid damage to the electric cable when moving the refrigerator.

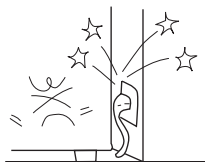

**Damaged electric cable**

When the electrical cable is damaged or worn, turn off the refrigerator and consult to an authorized service agent for replacement.



**Inflammable gas leakage in the vicinity of the refrigerator**

- \* Turn off any leaking valve;
- \* Open the doors and windows;
- \* Do not, under any circumstances, unplug electrical appliances in the vicinity of the leak.



**Unplug the refrigerator for the following:**

- \* Cleaning or maintenance
- \* Replacement of lamp

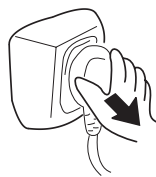

## After-sales service

In the event that the refrigerator does not work properly, please check out and solve problems according to the following methods. If problems persist, contact the after-sales service center. Information of model, accessory list and serial number of the refrigerator is required.

**Please determine the cause of the problem before making any repair.**

**The refrigerator does not operate.**



Disconnection to the power supply (plug, socket or fuse).

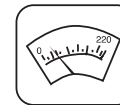

Voltage is low.

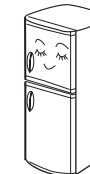

Automatic defrosting is activated. (Compressor ceases operation for 25 minutes)

**Lamp does not illuminate.**



The bulb is bad.



Power supply is not connected.

**Excessive noise**



Contact between the refrigerator and a wall or other article.



Uneven placement

**Set temperature is not reached.**

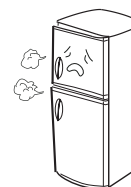

Door is not properly closed, or the door is opened for long period.



Refrigerator is in direct sunlight, or close to a heat source.



The area is poorly ventilated, or the two sides of the refrigerator are covered by too much dust.

## Troubleshooting

- WARNING: Keep ventilation openings in the appliance enclosure or in the built-in structure, clear of obstruction.
- WARNING: Do not use mechanical devices or other means to accelerate the defrosting process, other than those recommended by the manufacturer.
- WARNING: Do not damage the refrigerant circuit--(applicable only for appliances with refrigeration circuits which are accessible to the user).
- WARNING: Do not use electrical appliances inside the food storage compartments, unless they are of the type recommended by the manufacturer.

Excessive vibration will result in the following circumstances:

- a) The refrigerator is not well positioned and adjusted.
- b) The refrigerator is placed on a wood floor or near to wooden furniture.

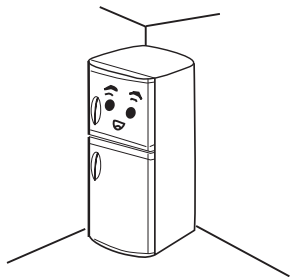

Liquid refrigerant flowing in the evaporator may produce a slight sound similar to that of flowing water. When the refrigerator is stopped, the backflow refrigerant may also generate that sound.

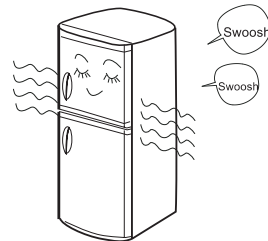

## Safety precautions

Never store inflammable, explosive or corrosive materials in the refrigerator.

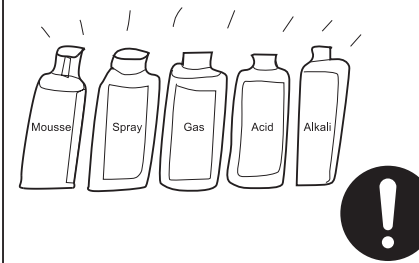

This refrigerator should be used for food storage. It is not recommended to place microbiological or chemical materials, which have special requirements in temperature setting.

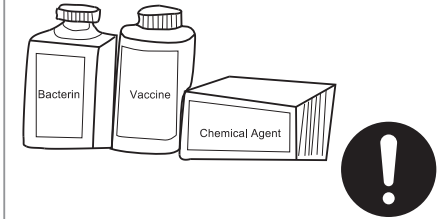

Do not install the refrigerator near gasoline or other inflammable articles.

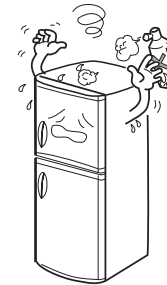

Don't place electrical plugs, regulators or microwaves on top of the refrigerator. Don't use electric appliances (except those allowed by manufacturer) inside the refrigerator.

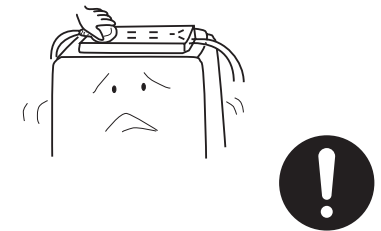

Do not swing on or apply excessive pressure to the refrigerator door.



Don't place heavy or unstable articles or water containers on top of the refrigerator.

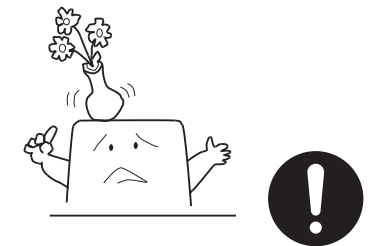

## Safety precautions

Avoid prolonged contact with the food in the freezer compartment when the refrigerator is operational, especially with wet hands. Hands may freeze onto the surface of the frozen food.



Do not spray or splash the refrigerator when cleaning the refrigerator, nor place the refrigerator in a damp area.

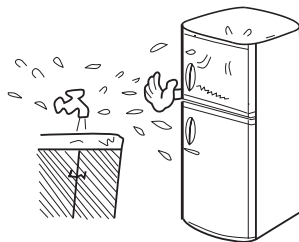

Disassembly, renovation or cooling system maintenance of refrigerator must be authorized.

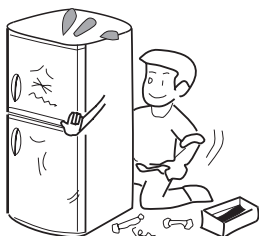

Never store bottled beer or beverages in the freezer compartment.



Unplug the refrigerator in the event of a power interruption or during cleaning. Allow at least 5 minutes lapse before restarting the refrigerator.

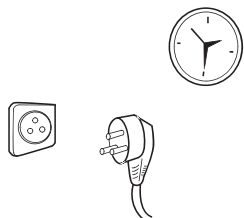

Remove the refrigerator door and door gasket if the refrigerator is discarded to prevent accidental entrapment in the refrigerator.

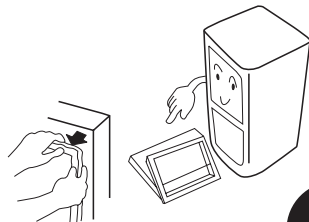

## Troubleshooting

A slight sound may be heard when the appliance is first started due to the operation of the compressor and motor. The sound will be lower and lower gradually a short period later.

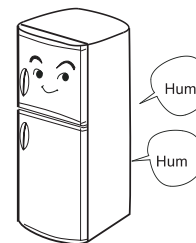

Temperature of the refrigerator and the compressor will rise and the compressor will run for comparatively longer periods when the refrigerator is first started.

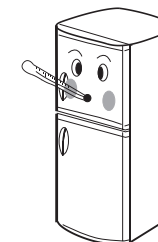

The fan of an operating refrigerator may produce a slight sound.

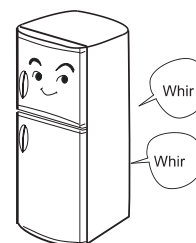

The compressor will operate for comparatively longer periods if excessive quantity of food is stored or the ambient temperature is high.

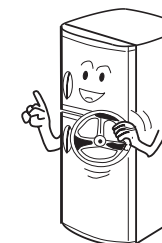

Water droplets may occur on outer surfaces and middle connection of the refrigerator due to heavy moisture in room air. Wipe clean with soft cloth.

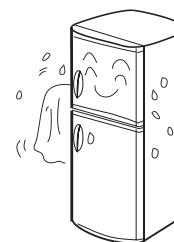

The two sides of the external surface and the middle connection of the refrigerator will be warm due to heat radiation of the appliance.

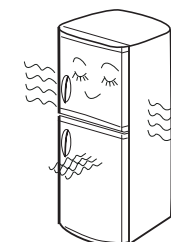

# Troubleshooting

The evaporator and piping system of the refrigerator may produce a slight sound when the refrigerator operates due to ambient temperature changes.

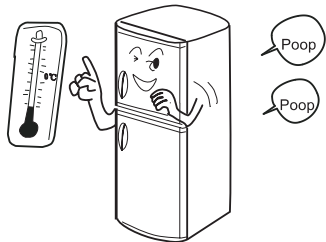

The thermostat, starting capacitor and heat protector may produce a slight sound when the refrigerator is started or closed.

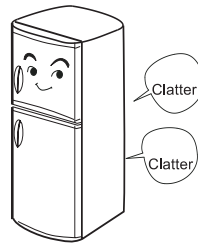

A slight sound may be produced by defrosting water flowing into the evaporating dish and the compressor at the moment of operation commencement or vacation.

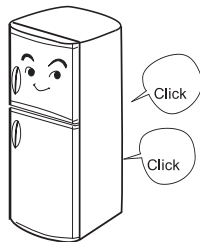

A slight continuous sound can be heard when the liquid refrigerant circulates to the evaporator.

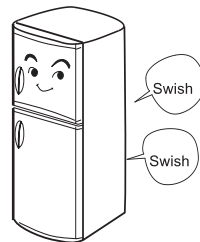

# Location

The refrigerator should be placed on a flat and solid surface. If the refrigerator is to be leveled, a flat, strong and fire-resistant material must be used. The foot of the refrigerator can be adjusted clockwise or anti-clockwise with a 22mm spanner to lift or lower the refrigerator if it is placed on an uneven surface.

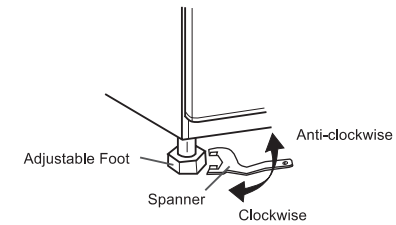

The refrigerator shall be placed away from heat sources or direct sunlight.

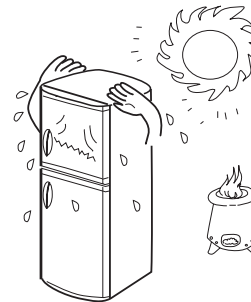

The refrigerator should be placed in a well-ventilated area, and a space of 10cm or more should be allowed around the refrigerator.

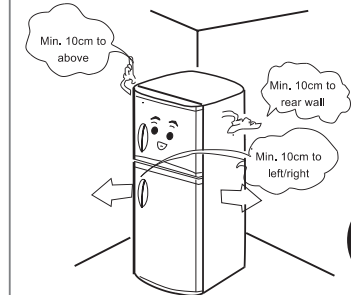

Never place the refrigerator near to a water source. Clean and dry any water splashes and stains with soft cloth.

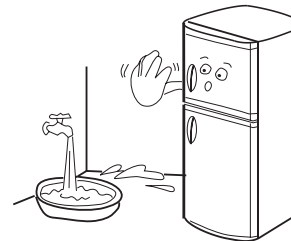

Never place the refrigerator in an area with an ambient temperature below zero. Never operate the refrigerator outdoors or in rain.

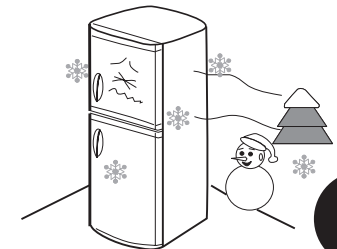

# Preparation

## 1. Unpacking

Remove all packing materials.

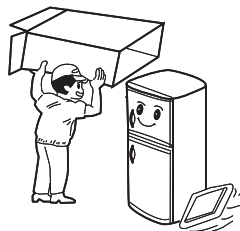

## 2. Check attached accessories and materials.

Check if all accessories specified in the Packing List are available. Contact the local distributor if shortage is found.



## 3. Ensure that the refrigerator is properly located.

(See section "Location")

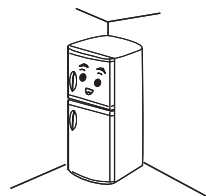

## 4. Clean the refrigerator before using.

(See section "Cleaning")

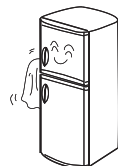

## 5. Time lapse before power supply

Connect the refrigerator to power source at least 30 minutes after the refrigerator is sited and cleaned.

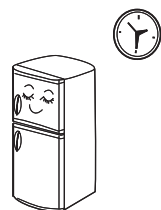

**Caution:** After unpacking, write down the model and manufacture number of the refrigerator on the Warranty Certificate which will be required if technical services are applied for.

# Vacation

## Before leaving for vacation

- \* Remove the food from refrigerator if the vacation is short. Turn the temperature selection knob to the proper position, and make sure that the door of the refrigerator is properly closed.
- \* If the vacation is long, take out the food from the refrigerator and disconnect the power. Wait until the frost inside melts, clean and dry the compartment. Leave the door open to prevent formation of bad odor.

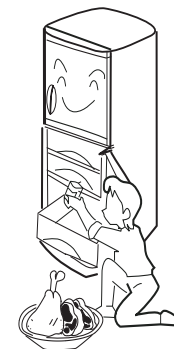

## Moving the refrigerator

- \* Unplug the refrigerator.
- \* Remove all the food.
- \* Secure the shelves in the cold storage compartment, vegetable and fruit tray and drawers in the freezer with tape.
- \* Tightly close and tape the door of the refrigerator.
- \* Do not tilt the refrigerator more than 45 degrees.

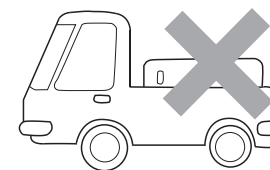
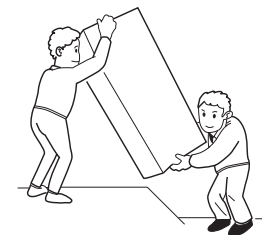

**Caution:** Never place the refrigerator horizontally.



# Vacation

## Power interruption

Even in summer, food can be stored in the refrigerator for a few hours after a power interruption.

\* Don't load food into the refrigerator during a power interruption and try to open the door as less frequently as possible.

\* If prior notice of a power interruption is given, make some ice and put it in a container in the top of the refrigeration compartment.

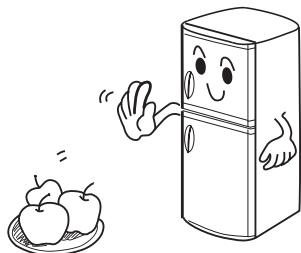

**Caution:** Temperature in the refrigerator will rise as for a power interruption or technical problem, and the storage period will be reduced.

## Ceased operation

If the refrigerator is to be ceased for an extended period, unplug the refrigerator and clean the refrigerator as previously described.

Keep the door of refrigerator open when the power is turned off to prevent any food remaining in the compartment from producing bad odors.

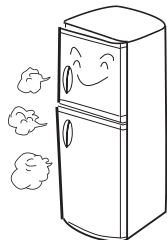

**Caution:** It is recommended that the refrigerator be not turned off unless it is necessary.



**Caution:** Do not restart the refrigerator until a period of at least five minutes has elapsed.

# Operation

## 1 Connection to power supply

## 2 Temperature setting and adjusting

### \* Adjusting freezing temperature

Temperature in the freezer compartment can be adjusted by setting the thermostat to the following positions on the dial: Position Min for higher temperature value and position Max for lower temperature value in the compartment. The thermostat can be set for desired temperature degrees as follows in the table.

### \* Adjusting refrigerating temperature

Temperature in the refrigerator compartment can be adjusted by setting the thermostat to the following positions on the dial: Position Min for higher and position Max for lower temperature values in the compartment (See table 1). Ambient temperature of the refrigerator should not be below 0°C.

Table 1

Position	Ambient Temperature
Min.	≥ 32°C
Mid.	16°C~32°C
Max.	≤ 16°C

## 3 Loading the refrigerator with food

Load the refrigerator with food when the set temperature of the refrigerator compartments is reached.

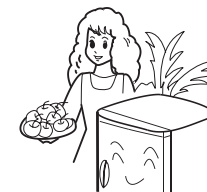

**Caution:** Some time will be required for the refrigerator to reach the set level when the temperature is adjusted. The length of this period is determined by difference in the existing and set temperatures, the ambient temperature, the frequency with which the door is opened and closed and the amount of food in storage.

## Refrigerating storage compartment

The refrigerator is for short-term food storage or for daily consumption.

Although the temperature in most areas in the refrigeration compartment can be regulated between 0°C and 10°C, extended periods of food storage is not recommended. Refrigerator should only be used for short-term storage.



### Storage areas

As cold air circulates inside the refrigerator, temperature differences exist inside the storage compartments. Area 6 is the coldest. Different foods should be placed in different areas according to their properties.

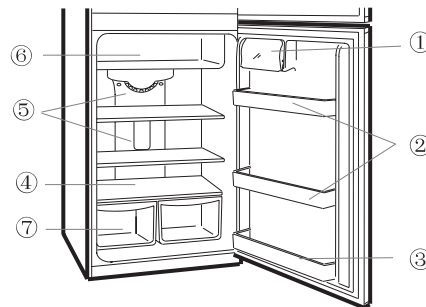

1. Eggs and butter
2. Canned food and seasoning
3. Beverages and bottled food
4. Pickled and canned food
5. Wheaten food, canned food, milk and bean curd
6. Cooked meat and sausages
7. Fruit, vegetables and salad



**Caution:** Ensure that the door of the chiller compartment is closed before closing refrigerator door.

### Lamp and replacement

Lamp: 200-240V~, 15W

Lamp holder: E14 (lamps exceeding 15W must not be used)

When replacing the lamp (upper figure: freezer lamp; lower figure: refrigerator lamp),

1. Unplug the appliance.
2. Remove the food shelf in front of the lamp.
3. Remove lampshade at frozen food storage compartment: put your forefinger into the hole and give adown energy to take the lampshade away. Remove lampshade at unfrozen food storage compartment: take the lampshade away according to arrowhead.
4. Rotate the lamp anticlockwise for removing and clockwise for installing.
5. When replacing the lampshade, ensure that all the lugs of the lampshade are settled into the slots of the lamp holder.

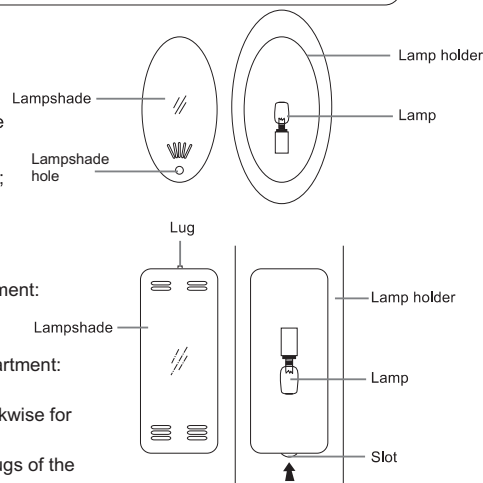

## Defrosting

### Automatic defrosting

This refrigerator is equipped with an automatic defrosting system.

## Cleaning

The refrigerator should be cleaned regularly to prevent the formation of bad odors.

\* Disconnect the power before cleaning the refrigerator.

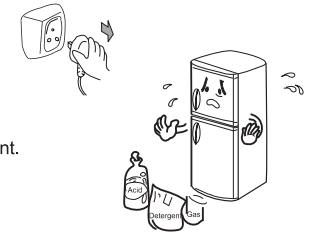

\* Clean the refrigerator with a soft cloth or sponge with mild detergent.



**Caution:** Do not use a hard brush, steel brush, detergent, gasoline or other solvents, hot water, acid or alkali for cleaning.

\* Dry water droplets on surfaces of the refrigerator with a piece of cloth.

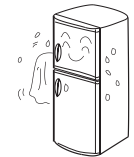

**Caution:** Do not use excessive amounts of water for cleaning the refrigerator. Use a dry cloth to clean the switch and the lamp.

\* Regularly clean the surfaces of the external shell to improve the heat elimination efficiency.



\* Always keep the door gasket clean



## Freezing storage precautions

Hot food should not be stored in the refrigerator until it has cooled down to room temperature.

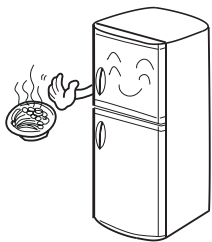

Food cut into small portions will freeze faster and be easier to defrost and cook. The recommended weight for each portion is less than 2.5kg.

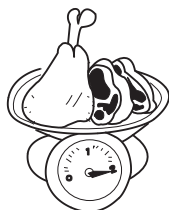

The outside of any food packing should be dried before storage in the freezer, and any packing materials should be odor-free, airtight, non-poisonous and nontoxic.

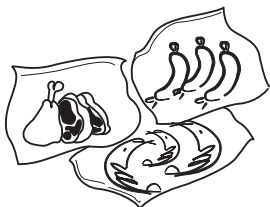

Food should be stored in accordance with any information printed on the packing.

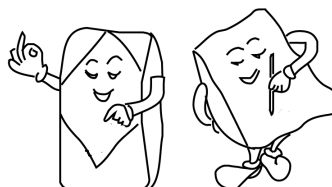

Only remove the required amount of food from the refrigerator. Defrosted food cannot be re-stored in the freezer unless it is first cooked.

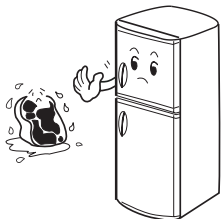

Do not load excessive quantity of food. Quantity of the food in storage shall comply with the cooling capacity of the refrigerator (See section "Technical Information").

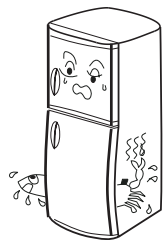

## Refrigerating storage precautions

Hot food must be cooled to room temperature before storing in the refrigerator.

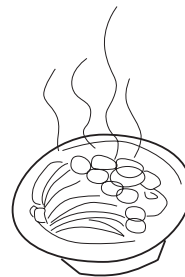

Dry any water droplets on the food before placing it in the refrigerator.



**Food to be stored should be properly sealed.**  
This will prevent moisture in the food from evaporating and prevent vegetables and fruit from tainting in flavor.



**Storage of sorted food**  
Food to be stored should be sorted according to consumer requirements. Food consumed daily should be placed in the most convenient area, this will minimize opening periods for the door.



**Do not store excess quantities or weights of food**

Food should be stored with spaces in between for better storage results. Never overload shelves, as they may collapse under excessive loads.

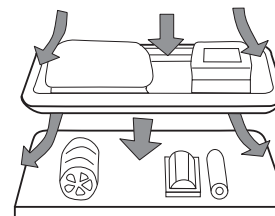

**Do not place food too close to the internal walls**  
Food with high moisture content should not be placed close to the walls of the inner liner. Maintain a space to prevent food from freezing to the walls.

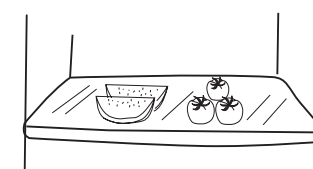

## Suggestions

Storage period will be extended if vegetables are placed with their roots towards the cold source.

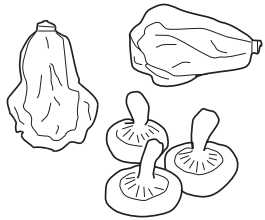

Leaves of carrots or turnips should be removed before storage.

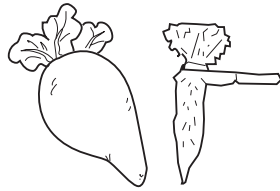

Eggs should be stored vertically in the egg holder.

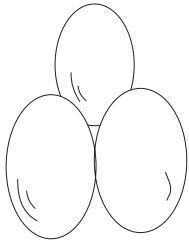

Frozen food can be placed in the cold compartment before serving, as this will conserve energy.



Onions, garlic, ginger, water chestnuts and other root vegetables should not be stored in the refrigerator, as these foods are suitable for long-term storage at normal temperatures.

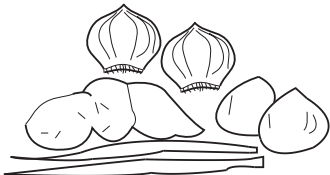

Ripe squash, melon, pawpaw, bananas and pineapples should not be stored in the refrigerator. Freezing will accelerate the ripening process.



## Freezing storage compartment

### Long-term storage of food

As the freezer storage temperature is very low, fresh food can be stored in the freezer compartment for a long time. Food requiring long-term storage can be stored in the frozen food compartment. Attention should be paid to the storage information printed on the food packing.

Suggested storage period is as follows:

Food	Edibility (Month)	Maximum (Month)
Chicken, beef, mutton and shrimps	4	9
Dumplings, ribs and ice-creams	4	6
Cakes, breads, sliced meat and cheese	2	6
Seafood, sausages and ice-creams	1	3

Storage period is subject to the detailed information on the food packing, property of the food for storage and special requirements.

### Making ice cubes

- \* Remove the ice moulds
- \* Pour water into the ice cube mould (Do not pour excess water over the water level mark, or ice cubes may not be easily removed.)
- \* Place the ice cube mould back to the freezer compartment.
- \* Turn clockwise the knob on front side of icemaker and then the ice cubes will drop into the ice cube tray.
- \* Tilt a bit the front side of ice cube tray when removing it from the refrigerator.

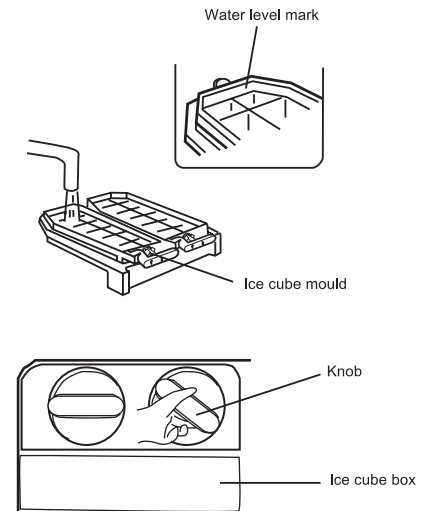

**Caution:** The ice cube box cannot be used for ice cube making or storage of other liquids that may result in frozen cracks.

## Free Manuals Download Website

<http://myh66.com>

<http://usermanuals.us>

<http://www.somanuals.com>

<http://www.4manuals.cc>

<http://www.manual-lib.com>

<http://www.404manual.com>

<http://www.luxmanual.com>

<http://aubethermostatmanual.com>

Golf course search by state

<http://golfingnear.com>

Email search by domain

<http://emailbydomain.com>

Auto manuals search

<http://auto.somanuals.com>

TV manuals search

<http://tv.somanuals.com>