

SPLIT TYPE ROOM AIR CONDITIONER

OPERATION MANUAL

HSU-12CR03-Y

HSU-18CR03-Y

- Please read this operation manual before using the air conditioner.

0010515222

Cautions

Disposal of the old air conditioner

Before disposing an old air conditioner that goes out of use, please make sure it's inoperative and safe. Unplug the air conditioner in order to avoid the risk of child entrapment.

It must be noticed that air conditioner system contains refrigerants, which require specialized waste disposal. The valuable materials contained in an air conditioner can be recycled. Contact your local waste disposal center for proper disposal of an old air conditioner and contact your local authority or your dealer if you have any question. Please ensure that the pipework of your air conditioner does not get damaged prior to being picked up by the relevant waste disposal center, and contribute to environmental awareness by insisting on an appropriate, anti-pollution method of disposal.

Disposal of the packaging of your new air conditioner

All the packaging materials employed in the package of your new air conditioner may be disposed without any danger to the environment.

The cardboard box may be broken or cut into smaller pieces and given to a waste paper disposal service. The wrapping bag made of polyethylene and the polyethylene foam pads contain no fluorochloric hydrocarbon.

All these valuable materials may be taken to a waste collecting center and used again after adequate recycling.

Consult your local authorities for the name and address of the waste materials collecting centers and waste paper disposal services nearest to your house.

Safety Instructions and Warnings

Before starting the air conditioner, read the information given in the User's Guide carefully. The User's Guide contains very important observations relating to the assembly, operation and maintenance of the air conditioner.

The manufacturer does not accept responsibility for any damages that may arise due to non-observation of the following instruction.

- Damaged air conditioners are not to be put into operation. In case of doubt, consult your supplier.
- Use of the air conditioner is to be carried out in strict compliance with the relative instructions set forth in the User's Guide.
- Installation shall be done by professional people, don't install unit by yourself.
- For the purpose of the safety, the air conditioner must be properly grounded in accordance with specifications.
- Always remember to unplug the air conditioner before opening inlet grill. Never unplug your air conditioner by pulling on the power cord. Always grip plug firmly and pull straight out from the outlet.
- All electrical repairs must be carried out by qualified electricians. Inadequate repairs may result in a major source of danger for the user of the air conditioner.
- Do not damage any parts of the air conditioner that carry refrigerant by piercing or perforating the air conditioner's tubes with sharp or pointed items, crushing or twisting any tubes, or scraping the coatings off the surfaces. If the refrigerant spurts out and gets into eyes, it may result in serious eye injuries.

Cautions

- Do not obstruct or cover the ventilation grille of the air conditioner. Do not put fingers or any other things into the inlet/outlet and swing louver.
- Do not allow children to play with the air conditioner. In no case should children be allowed to sit on the outdoor unit.

Specifications

- The refrigerating circuit is leak-proof.

The machine is adaptive in following situation

1. Applicable ambient temperature range:

Cooling	Indoor	Maximum:D.B/W.B Minimum:D.B/W.B	35°C/24°C 18°C/14°C
	Outdoor	Maximum:D.B/W.B Minimum: D.B	46°C/27°C 18°C

2. If the power supply cord is damaged, it must be replaced by the manufacturer or its service agent or a similar qualified person.
3. If the fuse of indoor unit on PC board is broken, please change it with the type of T. 3.15A/ 250V.
4. The wiring method should be in line with the local wiring standard.
5. After installation, the power plug should be easily reached.
6. The waste battery should be disposed properly.

7. The appliance is not intended for use by young children or infirm persons without supervision.
8. Young children should be supervised to ensure that they do not play with the appliance.
9. Please employ the proper power plug, which fit into the power supply cord.
10. The power plug and connecting cable must have acquired the local attestation.
11. In order to protect the units, please turn off the A/C first, and at least 30 seconds later, cutting off the power.

Cautions

Safety Instruction

- Please read the following Safety Instructions carefully prior to use.
- The instructions are classified into two levels, WARNING and CAUTION according to the seriousness of possible risks and damages as follows. Compliance to the instructions are strictly required for safety use.

Installation

⚠ WARNING

Please call Sales/Service Shop for the Installation.
Do not attempt to install the air conditioner by yourself because improper works may cause electric shock, fire, water leakage.

Installation in a inadequate place may cause accidents. Do not install in the following place.

⚠ CAUTION

Connect the earth cable.

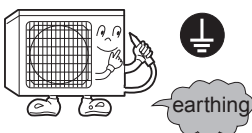

Do not install in the place where there is any possibility of inflammable gas leakage around the unit.



PROHIBITION

Do not get the unit exposed to vapor or oil steam.



PROHIBITION

Check proper installation of the drainage securely

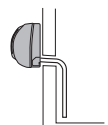

STRICT ENFORCEMENT

Cautions

⚠ WARNING

When abnormality such as burnt-smell found, immediately stop the operation button and contact sales shop.

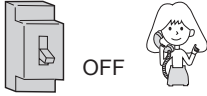

!
STRICT
ENFORCEMENT

Use an exclusive power source with a circuit breaker

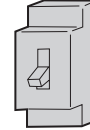

Connect power supply cord to the outlet completely



!
STRICT
ENFORCEMENT

Use the proper voltage



!
STRICT
ENFORCEMENT

Do not use power supply cord extended or connected in halfway

⊘
PROHIBITION

Do not use power supply cord in a bundle.

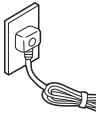

⊘
PROHIBITION

Take care not to damage the power supply cord.

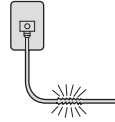

⊘
PROHIBITION

Do not insert objects into the air inlet or outlet.

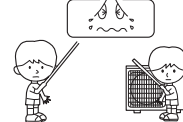

⊘
PROHIBITION

Do not start or stop the operation by disconnecting the power supply cord and so on.



⊘
PROHIBITION

Do not channel the air flow directly at people, especially at infants or the aged.



⊘
PROHIBITION

Do not try to repair or reconstruct by yourself.

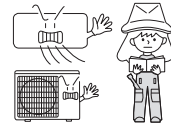

⚠ CAUTION

Do not use for the purpose of storage of food, art work, precise equipment, breeding, or cultivation.

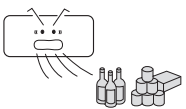

⊘
PROHIBITION

Take fresh air occasionally especially when gas appliance is running at the same time.

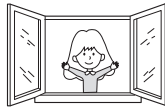

!
STRICT
ENFORCEMENT

Do not operate the switch with wet hand.

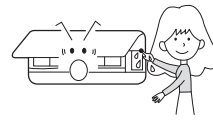

⊘
PROHIBITION

Do not install the unit near a fireplace or other heating apparatus.

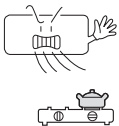

⊘
PROHIBITION

Check good condition of the installation stand

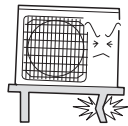

⊘
PROHIBITION

Do not pour water onto the unit for cleaning

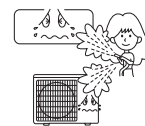

⊘
PROHIBITION

Do not place animals or plants in the direct path of the air flow

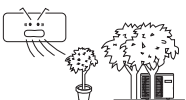

⊘
PROHIBITION

Do not place any objects on or climb on the unit.



⊘
PROHIBITION

Do not place flower vase or water containers on the top of the unit.



⊘
PROHIBITION

Parts and Functions

Indoor unit

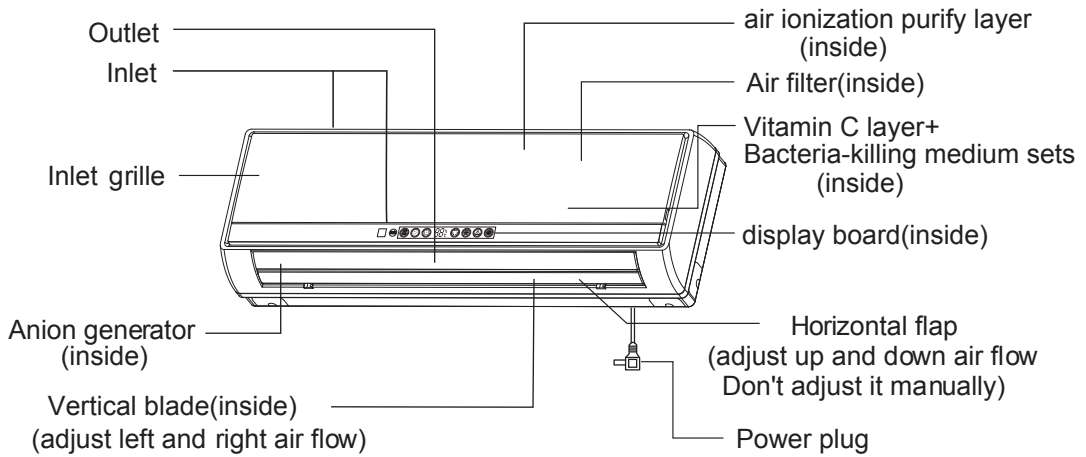

Outdoor unit

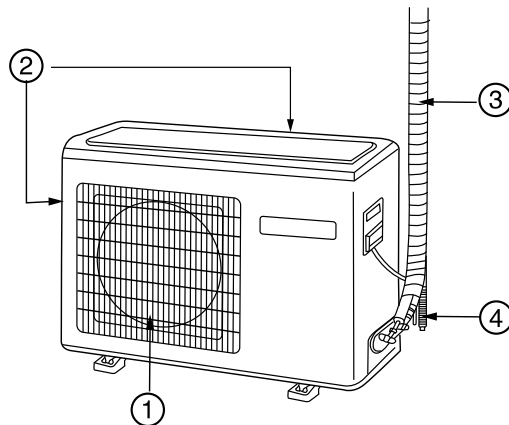

① OUTLET

③ CONNECTING PIPING AND ELECTRICAL WIRING

② INLET

④ DRAIN HOSE

Parts and Functions

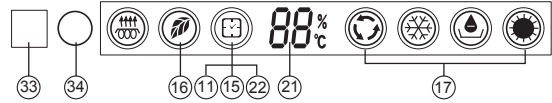
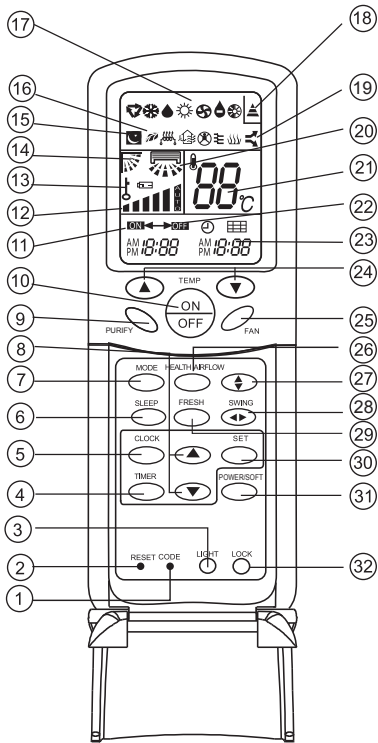

1. CODE

Used to select CODE A or B with a press, A or B will be displayed on LCD.
Please select A without special explanation.

2. RESET

When the remote controller appears abnormal, use a sharp pointed article to press this button to reset the remote controller normal.

3. LIGHT button

Control the lightening and extinguishing of the indoor LED display board.

4. TIMER button

Used to select TIMER ON, TIMER OFF, TIMER ON-OFF.

5. CLOCK button

Used to set correct time.

6. SLEEP button

Used to select sleep mode.

7. MODE button



8. HOUR button

Used to set clock and timer setting.

9. Purify button

Used to set air ionization purify and healthy function.

10. ON/OFF button

Used for unit start and stop.

11. TIMER ON display

12. FAN SPEED display



13. LOCK display

14. SWING UP/DOWN display

15. SLEEP display

16. HEALTH display

17. Operation mode display

Operation mode	AUTO	COOL	DRY	FAN
Remote controller				
Display board				

18. Singal sending display

19. POWER/SOFT display

20. Left/right air flow display

21. TEMP display

Remote controller: to display the TEMP. setting.

22. TIMER OFF display

23. CLOCK display

24. TEMP button

Used to select your desired temperature.

25. FAN button

Used to select fan speed: LOW, MED, HI, AUTO.

26. HEALTH AIRFLOW button

Used to set the health airflow mode.

27. SWING UP/DOWN button

Used to select up or down air sending direction.

28. SWING LEFT/RIGHT button

Used to select left/right air flow.

29. FRESH button(optional)

Use to set fresh air function.

30. SET button

Used to confirm timer and clock settings.

31. POWER/SOFT button

Used to set power/soft function.

32. LOCK

Used to lock buttons and LCD display. If pressed, the other buttons will be disabled and the lock condition display appears. Press it once again, lock will be canceled and lock condition display disappears.

33. Remote signal receiver

34. Emergency operation button(touch key)

Used to set emergency operation and test operation.

NOTE: 1. Cooling only unit do not have functions and displays related with heating.

2. The CODE button on this remote controller is not available.

Parts and Functions

■ Clock Set

When unit is started for the first time and after replacing batteries in remote controller, clock should be adjusted as follows:

1. Press CLOCK button, "AM" or "PM" flashes.
2. Press \triangle or ∇ to set correct time. Each press will increase or decrease 1 min. If the button is kept depressed, time will change quickly.
3. After time setting is confirmed, press SET, "AM" or "PM" stop flashing, while clock starts working.

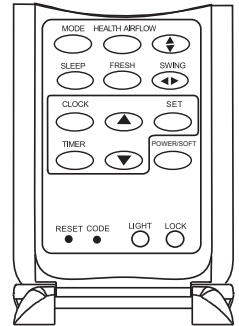

■ Remote controller's operation

- When in use, put the signal transmission head directly to the receiver hole on the indoor unit.
- The distance between the signal transmission head and the receiver hole should be within 7m without any obstacle as well.
- Don't throw or knock the remote controller.
- When electronic-started type fluorescent lamp or change-over type fluorescent lamp or wireless telephone is installed in the room, the receiver is apt to be disturbed in receiving the signals, so the distance to the indoor unit should be shorter.

■ Loading of the battery

Load the batteries as illustrated right
2 R-03 (7#) batteries

Remove the battery cover:

Slightly press "≡" area and push down the cover as illustrated.

Load the battery:

Be sure that the loading is in line with the "+" / "-".
request as illustrated on the bottom of the case.

Put on the cover again.

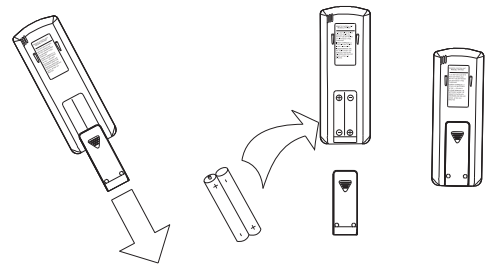

Confirmation indicator:

After pressing power ON/OFF, if no display, reload the batteries.

Note:

- Full display or unclear display during operation indicates the batteries have been used up. Please change batteries.
- Used two new same-typed batteries when loading.
- If the remote controller can't run normally during operation, please remove the batteries and reload several minutes later.

Hint:

Remove the batteries in case unit won't be in usage for a long period. If there are any display after taking-out, just need to press reset key.

Display board

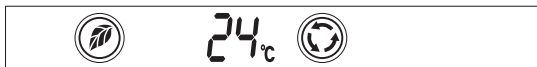

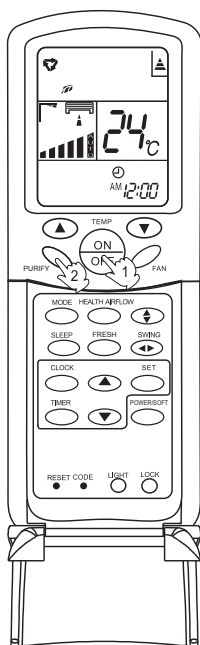

Remote controller



1. Unit start

Press ON/OFF on the remote controller, unit starts.

2. Health anion function

Press Purify button.  is displayed on the remote controller and  is displayed on the display board. Air conditioner starts air ionization purify and health anion function operation.

For twice press,  and  disappear, the operation stops.

When indoor fan motor is running, it has air ionization purify and healthy process function.

BRIEF INTRODUCTION TO AIR IONIZATION PURIFY AND HEALTH ANION FUNCTION

1. The anion generator in the air conditioner can generate a lot of anion effectively balance the quantity of position and anion in the air and also to kill bacteria and speed up the dust sediment in the room and finally clean the air in the room.
2. The purification function of AIP:
DC high voltage bring high voltage electrostatic field, which ionize air into positive and negative ion. a great deal of positive and negative ion adhere to dust passing by, so the dust become "particle with electric charge". so the dust passing by adheres to the AIP board under the force from the electric field, which purifies the unit.
3. When power off, press the purify button, the Remote controller shows "FAN, low, AIP, and negative ion", and the TIMER function is available.

Operation

Auto Operation

Display board

24°C

Remote controller

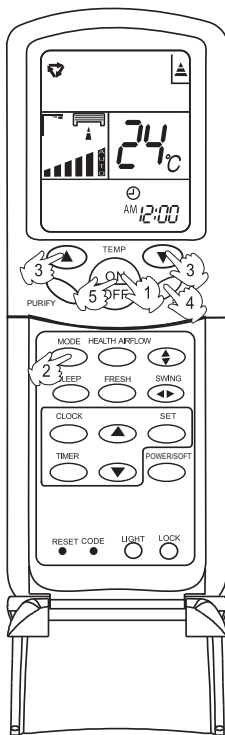

1. Unit start

Press ON/OFF on the remote controller, unit starts.

2. Select operation mode

Press MODE button. For each press, operation mode changes as follows:

Remote controller:

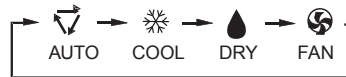

Then Select Auto operation

3. Select temp. setting

Press TEMP. button

△ Every time the button is pressed, temp. setting increase 1°C, if kept depressed, it will increase rapidly

▽ Every time the button is pressed, temp. setting decrease 1°C, if kept depressed, it will decrease rapidly

Select a desired temperature.

4. Fan speed selection

Press FAN button. For each press, fan speed changes as follows:

Remote controller:



Air conditioner is running under displayed fan speed. When FAN is set to AUTO, the air conditioner automatically adjusts the fan speed according to room temperature.

5. Unit stop

Press ON/OFF button, the unit stops.

About Auto Operation

Under the mode of auto operation, air conditioner will automatically select Cool, Dry or Fan operation according to room temperature.

Operation

Cool Operation

Display board

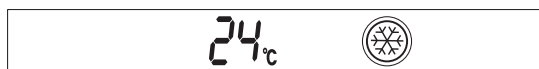

Remote controller

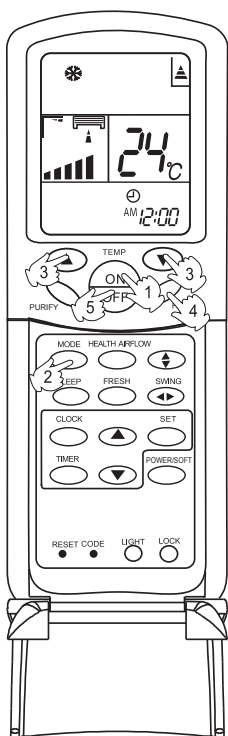

1. Unit start

Press ON/OFF on the remote controller, unit starts.

2. Select operation mode

Press MODE button. For each press, operation mode changes as follows:

Remote controller:

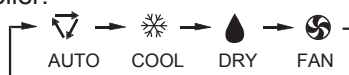

Then Select COOL operation

3. Select temp. setting

Press TEMP. button

△ Every time the button is pressed, temp. setting increase 1°C, if kept depressed, it will increase rapidly

▽ Every time the button is pressed, temp. setting decrease 1°C, if kept depressed, it will decrease rapidly

Select a desired temperature.

4. Fan speed selection

Press FAN button. For each press, fan speed changes as follows:

Remote controller:



Air conditioner is running under displayed fan speed. When FAN is set to AUTO, the air conditioner automatically adjusts the fan speed according to room temperature.

5. Unit stop

Press ON/OFF button, the unit stops.

Operation

Dry Operation

Display board



Remote controller

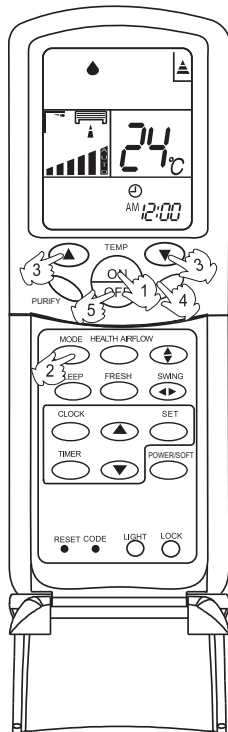

1. Unit start

Press ON/OFF on the remote controller, unit starts.

2. Select operation mode

Press MODE button. For each press, operation mode changes as follows:

Remote controller:

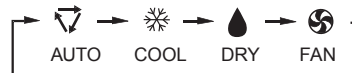

Then Select DRY operation

3. Select temp. setting

Press TEMP. button

△ Every time the button is pressed, temp.setting increase 1°C, if kept depressed, it will increase rapidly

▽ Every time the button is pressed, temp.setting decrease 1°C, if kept depressed, it will decrease rapidly

Select a desired temperature.

4. Fan speed selection

Press FAN button. For each press, fan speed changes as follows:

Remote controller:



Air conditioner is running under displayed fan speed.

In DRY mode, when room temperature becomes lower than temp.setting+2°C, unit will run intermittently at LOW speed regardless of FAN setting.

5. Unit stop

Press ON/OFF button, the unit stops.

COOL operation starts when room temp. is higher than temp.setting.

Ultra-low air flow

Temp.setting+2°C
Temp.setting



On reaching temp.setting +2°C unit will run in mild DRY mode.

Operation

Fan Operation

Display board

24°C

Remote controller

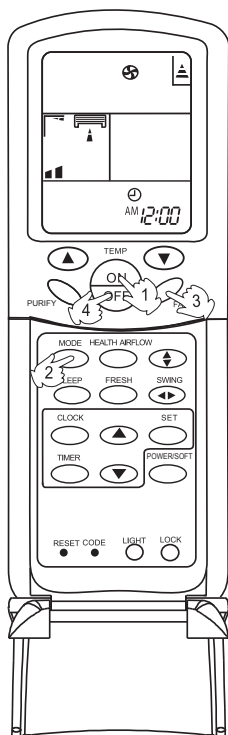

1. Unit start

Press ON/OFF on the remote controller, unit starts.

2. Select operation mode

Press MODE button. For each press, operation mode changes as follows:

Remote controller:



Then Select FAN operation

3. Fan speed selection

Press FAN button. For each press, fan speed changes as follows:

Remote controller:



4. Unit stop

Press ON/OFF button, the unit stops.

About FAN operation

In FAN operation mode, the unit will not operate in COOL mode but only in FAN mode, AUTO is not available in FAN mode. And temp. setting is disabled. In FAN mode, SLEEP operation is not available.

Operation

Air Flow Direction Adjustment

1. Status display of air sending

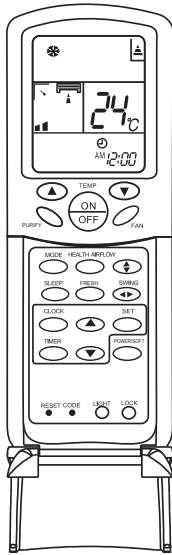

Horizontal flap

- Pos.1
- Pos.2
- Pos.3
- Pos.4
- Pos.5
- Pos.6

Vertical blade

- Pos.1
- Pos.2
- Pos.3
- Pos.4
- Pos.5
- Pos.6
- Pos.7
- Pos.8

2. Up and down air flow direction

For each press of button, air flow direction on remote controller displays as follows according to different operation modes:

COOL/DRY/FAN remote controller:

AUTO: remote controller:

The horizontal flap will swing according to the above positions

3. Left and right air flow direction

For each press of button, remote controller displays as follows : remote controller:

The vertical blade will swing according to the above positions.

Note: When restart after remote turning off, the remote controller will automatically memorize the previous set swing position.

Operation

Sleep Operation

Display board



Operation

Before going to bed, you can simply press the SLEEP button and unit will operate in SLEEP mode and bring you a sound sleep.

Use of SLEEP function

After the unit starts, set the operation status, then press SLEEP button before which the clock must be adjusted and time being set.

Operation Mode

1. In COOL, DRY mode

1 hours after SLEEP mode starts, temp. will become 1°C higher than temp. setting. After another 1 hours, temp. rises by 1°C further. The unit will run for further 6 hours then stops. Temp. is higher than temp. setting so that room temperature won't be too low for your sleep.

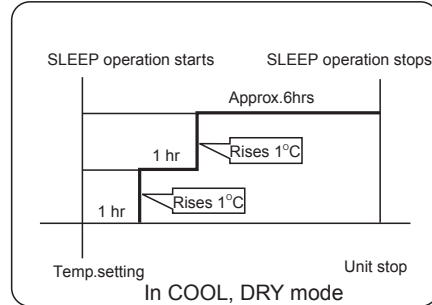

Remote Controller

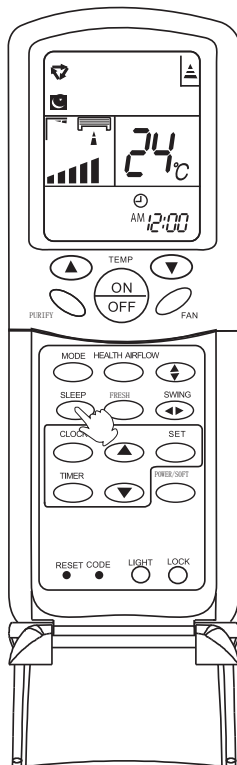

2. In AUTO mode

The unit operates in corresponding sleep mode adapted to the automatically selected operation mode.

3. In FAN mode

It has no SLEEP function.

4. When TIMER function is set, the sleeping function can't be set up. After the sleeping function is set up, if user resets TIMER function, the sleeping function will be cancelled; the machine will be in the state of timing-on.

5. Note to the power failure resume:

press the sleep button ten times in five seconds and enter this function after hearing four sounds. And press the sleep button ten times within five seconds and leave this function after hearing two sounds.

Power Failure Resume Function

If the unit is started for the first time, the compressor will not start running unless 3 minutes have elapsed. When the power resumes after power failure, the unit will run automatically, and 3 minutes later the compressor starts running

Operation

Timer On/Off Operation

Display board



Remote Controller

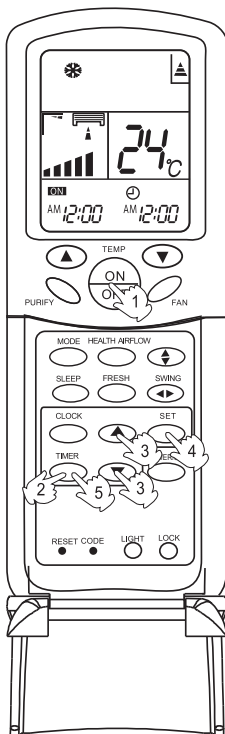

Set clock correctly before starting TIMER operation.

1. After unit starts, select your desired operation mode
Operation mode will be displayed on LCD.

2. Timer mode selection

Press TIMER button to change TIMER mode. Every time the button is pressed, display changes as follows:

Remote controller:



Then select your desired TIMER mode (TIMER ON or TIMER OFF). " ON " or " OFF " will flash.

3. Time setting

Press HOUR Δ / ∇ button.

Δ Every time the button is pressed, time setting increases 1 min, if kept depressed, it will increase rapidly.

∇ Every time the button is pressed, time setting decreases 1 min, if kept depressed, it will decrease rapidly.

It can be adjusted within 24 hours.

4. Confirming your setting

After setting correct time, press SET button to confirm
" ON " or " OFF " on the remote controller stops flashing.

Time displayed: Unit starts or stops at x hour x min.
(TIMER ON or TIMER OFF).

5. Cancel TIMER mode

Just press TIMER button several times until TIMER mode disappears.

Hints:

After replacing batteries or a power failure happens, time setting should be reset.

Remote controller possesses memory function, when use TIMER mode next time, just press SET button after mode selecting if time setting is the same as previous one.

Operation

Timer On-Off Operation

Display board



Remote Controller

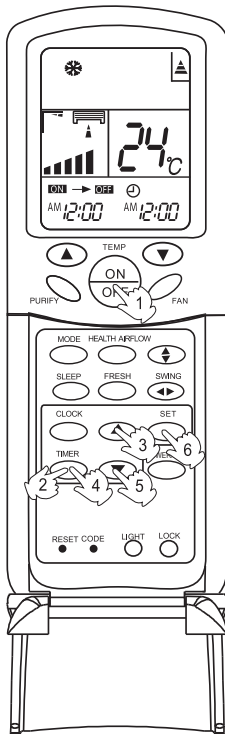

Set clock correctly before starting
TIMER operation.

1. After unit starts, select your
desired operation mode . Operation mode will be
displayed on LCD.

2. Timer mode selection

Press TIMER button to change TIMER mode. Every time
the button is pressed, display changes as follows:

Remote controller:



Then select your desired TIMER mode (TIMER ON - OFF).
" ON " will flash.

3. Time setting

Press HOUR Δ / ∇ button.

- Δ Every time the button is pressed, time setting increases
1 min, if kept depressed, it will increase rapidly.
- ∇ Every time the button is pressed, time setting decreases
1 min, if kept depressed, it will decrease rapidly.
It can be adjusted within 24 hours.

4. Timer confirming for TIMER ON

After setting correct time, press TIMER button to confirm
" ON " on the remote controller stops flashing.

" OFF " starts flashing.

Time displayed: Unit starts or stops at x hour x min.

5. Time setting for TIMER OFF

Just press HOUR button ,follow the same procedure in
"Time setting for TIMER ON"

6. Time confirming for TIMER OFF

After time setting,press SET button to confirm.

" OFF " on the remote controller stops blinking.

Time displayed:Unit stops at x hour x min.

To cancel TIMER mode

Just press TIMER button several times until TIMER
mode disappears.

According to the Time setting sequence of TIMER ON
or TIMER OFF, either Start-Stop or Stop-Start can be
achieved.

Remote controller

POWER Operation

When you need rapid cooling, you can use this function.

Selecting of POWER operation

Press POWER/SOFT button. Every time the button is pressed, display changes as follows:



Stop the display at " ⚡ ".

In POWER operation status:

In COOL mode, compressor runs in high frequency for 15 min then returns to original status setting.

To cancel POWER operation

Press POWER/SOFT button twice, POWER/SOFT disappears.

SOFT Operation

You can use this function when silence is needed for rest or reading.

Selecting of SOFT operation

Press POWER/SOFT button. Every time the button is pressed, display changes as follows:



Stop the display at " ⤴ ".

In SOFT operation mode, fan speed automatically takes "ultra-low"

To cancel SOFT operation

Press POWER/SOFT button twice, POWER/SOFT disappears.

Hints:

During POWER operation, in rapid COOL mode, the room will show inhomogeneous temperature distribution.

Long period SOFT operation will cause effect of not too cool.

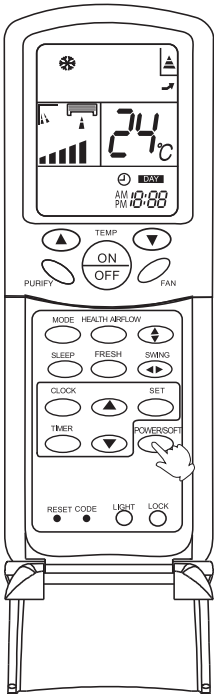

Operation

Health airflow Operation

Remote controller

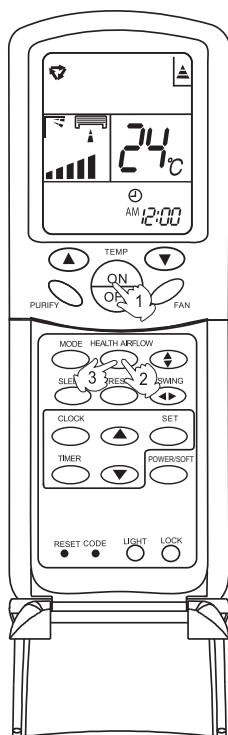

1. Press ON/OFF to starting

The liquid crystal will display the working state of last time (Except timer, sleeping, power/soft and health airflow). Setting the comfort work conditions.

2. The setting of health airflow function

1). Press the button of health airflow,  appears on the display. The nether inlet and outlet grills of the air conditioner are closed and the airflow is blown horizontally from the above inlet and outlet grills. Avoid the strong airflow blows direct to the body.

2). Press the button of health airflow again,  appears on the display. The above inlet and outlet grills of the air conditioner are closed and the airflow is blown vertically from the nether inlet and outlet grills. Avoid the strong airflow blows direct to the body.

3. The cancel of the health airflow function

Press the button of health airflow again, both the inlet and outlet grills of the air conditioner are opened, and the unit goes on working under the condition before the setting of health airflow function.

After stopping, the outlet grille will close automatically.

Notice: Cannot pull direct the outlet grille by hand. Otherwise, the grille will run incorrectly. If the grille is not run correctly, stop for a minute and then start, adjusting by remote controller.

Note:

1. After setting the health airflow function, the position of inlet and outlet grills is fixed.
2. In cooling, it is better to select the  mode.
3. In cooling and dry, using the air conditioner for a long time under the high air humidity, a phenomenon falling drips of water occurs at the outlet grille .
4. Select the appropriate fan direction according to the actual conditions.

Operation

Emergency and Test Operation (wall-mounted type)

Emergency operation

- Use this operation only when the remote controller is defective or lost.
- When the emergency operation switch is pressed, the "Pi" sound is heard once, which means the start of this operation.
- In this operation, the system automatically selects the operation modes, cooling or fan, according to the room temperature.

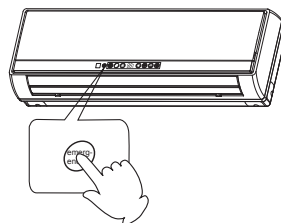

Temperature	Operation mode	Designated temperature	Timer mode	Air flow
ABOVE 21°C	COOLING	24°C	NO	AUTOMATIC
BELOW 21°C	FAN	24°C	NO	AUTOMATIC

- It is not possible to operate in dry mode.

Test operation

Test operation switch is the same as emergency switch.

- Use this switch in the test operation when the room temperature is below 16°C, do not use it in the normal operation.
- Continue to press the test operation switch for more than 5 seconds. After you hear the "Pi" sound twice, release your finger from the switch: the cooling operation starts with the air flow speed "Hi".
- After 30 minutes, test operation ends automatically.

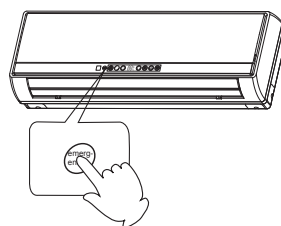

Removal of the restriction of emergency or test operation

- Press the emergency operation switch once more, or manipulate through the remote controller; the "Pi" sound, the emergency or test operation is terminated.
- When the remote controller is manipulated, it gets the system back to the normal operation mode.

Maintenance

For Smart Use of The Air Conditioner

Setting of proper room temperature

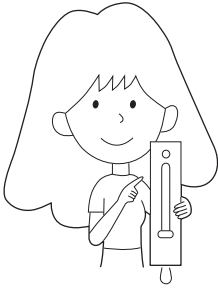

Proper temperature

Do not block the air inlet or outlet

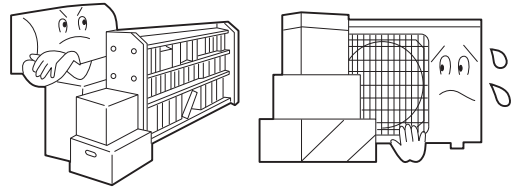

Close doors and windows during operation

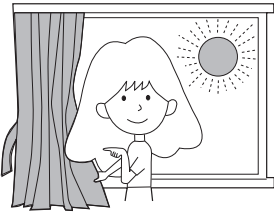

During cooling operation prevent the penetration of direct sunlight with curtain or blind

Use the timer effectively

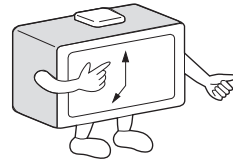

If the unit is not to be used for a long time, turn off the power supply main switch.

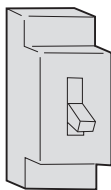

OFF

Use the louvers effectively

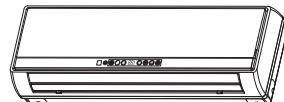

Maintenance

For Smart Use of The Air Conditioner

WARNING

Before maintenance, be sure to turn off the system and the circuit breaker.

Remote Controller



Do not use water, wipe the controller with a dry cloth. Do not use glass cleaner or chemical cloth.

Indoor Body

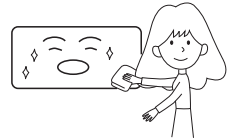

Wipe the air conditioner by using a soft and dry cloth. For serious stains, use a neutral detergent diluted with water. Wring the water out of the cloth before wiping, then wipe off the detergent completely.

Do not use the following for cleaning



Gasoline, benzene, thinner or cleanser may damage the coating of the unit.



Hot water over 40°C (104°F) may cause discoloring or deformation.

Air Filter cleaning

1 Open the inlet grille by pulling it upward.

2 Remove the filter.

Push up the filter's center tab slightly until it is released from the stopper, and remove the filter downward.

3 Clean the filter.

Use a vacuum cleaner to remove dust, or wash the filter with water. After washing, dry the filter completely in the shade.

4 Attach the filter.

Attach the filter correctly so that the "FRONT" indication is facing to the front. Make sure that the filter is completely fixed behind the stopper. If the right and left filters are not attached correctly, that may cause defects.

5 Close the inlet grille.

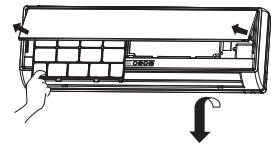

Once every two weeks

Maintenance

The installation and cleanout AIP layer, VC layer + Bacteria-killing medium sets

1. Open the Inlet Grille

The inlet grill is supported by its top plate at the right side.

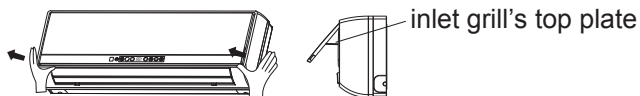

2. Detach the standard air filter

Push up the filter's center tab slightly until it is released from the stopper, and remove the filter downward.

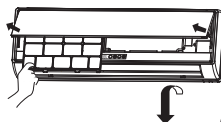

3. Take the VC layer + Bacteria-killing medium sets

Take out the VC layer or the Bacteria-killing medium sets from the filter. Push the bottom frame of AIP layer, and push up the handle at the same time in order to take out the AIP layer board in turns.

AIP (air ionization purify)
(bottom frame)

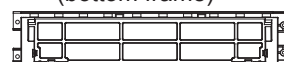

(AIP board)

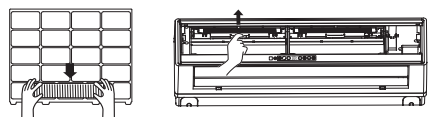
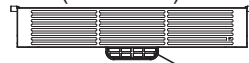

Note: the green aspect of the bacteria-killing medium air purifying filter will face outside, the white aspect will face to the machine. The yellow aspect of the VC layer will face outside, the white aspect will face to the machine.

4. The installation of AIP layer, VC layer + Bacteria-killing medium sets (must be installed)

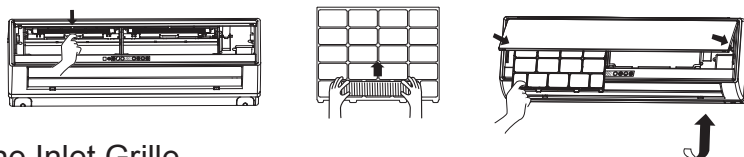

5. Close the Inlet Grille

Put down the inlet grill's top plate, and close the inlet grill.

➤ Common sense:

● In order to keep the AIP layer having a highly work effect, it should be cleaned regularly or aperiodically just according to the working environment.

1. Turn off the A/C electricity supply and make sure that AIP layer is not working. Then clean the AIP layer after turning off it five minutes later.
2. Please brush off the dust on AIP board, then steep it into cleaning agent water and wash it.
3. After cleaning AIP board please put it on a dry place until it is totally dry.
4. Ensure AIP board is dry enough then install it in its position along the slide way. Make sure it is as before and could work well.

● The AIP layer will be replaced in fixed time. In normal family, it will be replaced every 6 months.

● In the use, please note to clean the filter frequently (take off the back suction cleaner or lightly pat it) to avoid the operating effect is lowered due to the dust covering the filter. AIP layer and bacteria-killing medium filter is strictly prohibited from being cleaned by water.

The bacteria-killing medium filter not in use should be stored in shade, cool and dry place.

Please don't expose it to the sunlight for a long time otherwise the degerming performance will drop.

Maintenance

To Keep Your Air conditioner in Good Condition after Season.

1. Operate in cooling mode for 2-3 hours.

To prevent breeding mold or bad smell, be sure to operate at the designated temperature or 30°C, cooling mode and High speed fan mode for 2-3 hours.

2. Put off the power supply cord.

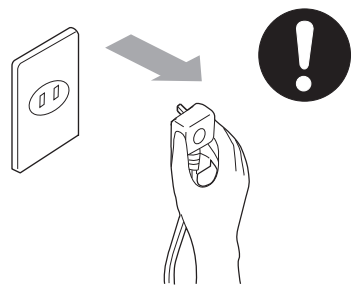

3. Cleaning the body.

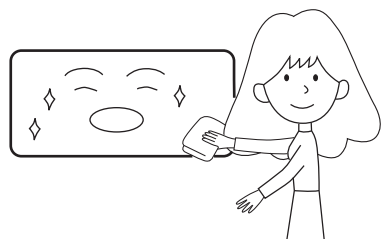

4. Take out the batteries from the wireless remote controller.

Maintenance

Before Setting in High season

1. Cleaning the standard air filter.

Operation without filter may cause troubles. Be sure to attach both right and left filters prior to the operation. Each of them are of different shapes.

2. Connecting the earthing cable.

Caution

- Incomplete earthing may cause an electric shock.

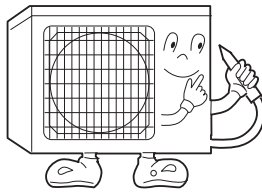

3. Do not block the air inlet or outlet.

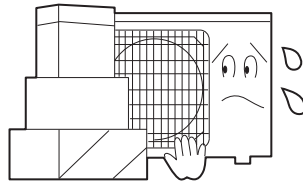
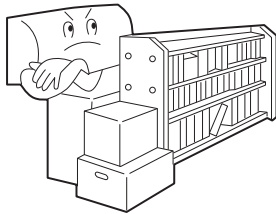

4. Plug-in



Caution

- After brush away dust at the plug, insert the plug of the power supply cord into the outlet completely. In case of using exclusive circuit breaker, switch on the circuit breaker.



Trouble shooting

Before asking for service, check the following first.

	Phenomenon	Cause or check points
Normal Performance inspection	<p>The system does not restart immediately.</p> 	<ul style="list-style-type: none"> • When unit is stopped, it won't restart immediately until 3 minutes have elapsed to protect the system. • When the electric plug is pulled out and reinserted, the protection circuit will work for 3 minutes to protect the air conditioner.
	<p>Noise is heard:</p> 	<ul style="list-style-type: none"> • During unit operation or at stop, a swishing or gurgling noise may be heard. At first 2-3 minutes after unit start, this noise is more noticeable. (This noise is generated by refrigerant flowing in the system.) • During unit operation, a cracking noise may be heard. This noise is generated by the casing expanding or shrinking because of temperature changes. • Should there be a big noise from air flow in unit operation, air filter may be too dirty.
	<p>Smells are generated.</p>	<ul style="list-style-type: none"> • This is because the system circulates smells from the interior air such as the smell of furniture, cigarettes.
	<p>Mist or steam are blown out.</p>	<ul style="list-style-type: none"> • During COOL or DRY operation, indoor unit may blow out mist. This is due to the sudden cooling of indoor air.
Multiple check	<p>Does not work at all.</p>	<ul style="list-style-type: none"> • Is power plug inserted? • Is there a power failure? • Is fuse blown out?
	<p>Poor cooling</p> 	<ul style="list-style-type: none"> • Is the air filter dirty? Normally it should be cleaned every 15 days. • Are there any obstacles before inlet and outlet? • Is temperature set correctly? • Are there some doors or windows left open? • Is there any direct sunlight through the window during the cooling operation?(Use curtain) • Are there too much heat sources or too many people in the room during cooling operation?

Free Manuals Download Website

<http://myh66.com>

<http://usermanuals.us>

<http://www.somanuals.com>

<http://www.4manuals.cc>

<http://www.manual-lib.com>

<http://www.404manual.com>

<http://www.luxmanual.com>

<http://aubethermostatmanual.com>

Golf course search by state

<http://golfingnear.com>

Email search by domain

<http://emailbydomain.com>

Auto manuals search

<http://auto.somanuals.com>

TV manuals search

<http://tv.somanuals.com>