

H@ier

Haier
■

Haier Network Air Conditioner

Two by One Room Air Conditioner

AB422BCBAA

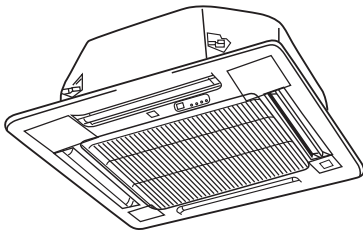

CONTENTS

Before Use

Operation Points*****	1-2
Name of Parts*****	3-5
Safety Precautions*****	6-7

Operation Instruction

Fan Operation*****	8
Auto, Cooling, Dehumidifying, Heating operation*****	9
Swing Operation*****	10
Sleep Function*****	11
Timer On/Off Function*****	12
Timer On-Off Function *****	13
Users' Attention*****	14

Maintenance

Maintenance *****	15-19
Troubleshooting*****	20-21

Installation of Indoor Unit

Installation Instruction*****	22	* 23
Installation Procedure *****	24*34	
Other Instruction and Test Run****	35	

No. * 0010571740

- Please read this manual carefully before using
- Please keep this manual for future use

Characteristics of Products

Characteristics of Products

1. Four-direction air sending, more even temperature adjustment.
2. Inner hidden type installation, space-saving; harmonized with the ceiling, exquisite and beautiful.
3. Powerful circular air volume, quick temperature adjustment.
4. This air conditioner has POWER FAILURE RESUME FUNCTION.
5. Anti-bacteria mildew resistant air filter, fresher air creates more healthy.
6. This unit has the function of far distance monitoring. Through the telephone network, it can be effectively controlled in any other far-distance place.
(Only after equipped with the "far distance detector" made by our company can this function be fulfilled.)

Far distance monitoring

There is a pre-set far distance control communication interface on the control panel of indoor unit. After installing the peripheral equipment according to the manual attached with the Haier made far distance control detector, the computer management or other place monitoring can be achieved to the air conditioner.

Operation points

Operation of air conditioner

When the ambient humidity is too high, in COOLING or DEHUMIDIFYING mode, there may be water dropped in the air outlet.



3-minute protection function

If start the unit immediately only after it is turned off, the compressor will start after 3 minutes have elapsed to protect the compressor.



Change of fan speed

In COOLING mode, the air sending is set at AUTO, when the indoor temperature is near the set temperature, the fan speed will lower automatically. In HEATING mode, when room temperature reaches the set temperature, the compressor will stop running, and the fan will change to LOW FAN or stop. In DEHUMIDIFYING mode, the fan speed will change automatically.



Far distance monitoring

There is a pre-set far distance control communication interface on the control panel of indoor unit. After installing the peripheral equipment according to the manual attached with the Haier made far distance control detector, the computer management or other place monitoring can be achieved to the air conditioner.

Operation points

Anti-cold air blowing out

During Heating operation, after starting the unit, the indoor fan motor will not rotate immediately to prevent cold air from blowing out.

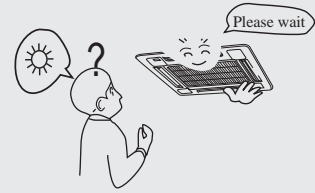

Defrosting function

During Heating operation, when frost formed on the heat exchanger of outdoor unit, the air conditioner will defrost automatically for several minutes. During defrosting, both the fan of indoor and outdoor unit do not run. After finishing defrosting, the air conditioner will automatically resume operation.

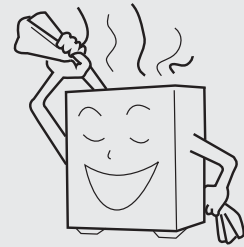

Hint

When the air conditioner is in Heating mode, it absorbs heat from outside and release to indoors. So the outdoor temperature may affect the Heating effect.

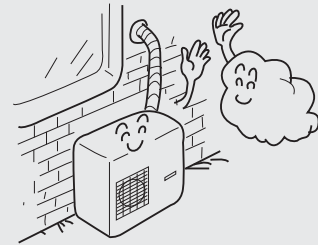

Power failure resume function (please set and use this function according to actual condition)

After setting power failure resume function, if there is a sudden power failure during unit operation, when power on for again, the unit will resume the previous state.

Setting method: when the remote controller is in ON state (except for TIMER and FAN mode), press the SLEEP button for 10 times in 5 seconds, after the buzzer sounds 4 times, the unit will change to POWER FAILURE RESUME function.

Cancellation method: press the SLEEP button 10 times in 5 seconds, after the buzzer 2 times, the POWER FAILURE RESUME function is cancelled.

Note: After the unit is set POWER FAILURE RESUME function, if there is a sudden power failure in using, during this period of time if there is no need to use the unit for a long time, please cut off power to prevent the air conditioner from automatically resuming to the previous setting if power failure resumes, or press the ON/OFF button to turn off the unit after power failure resumes.

Name of Parts

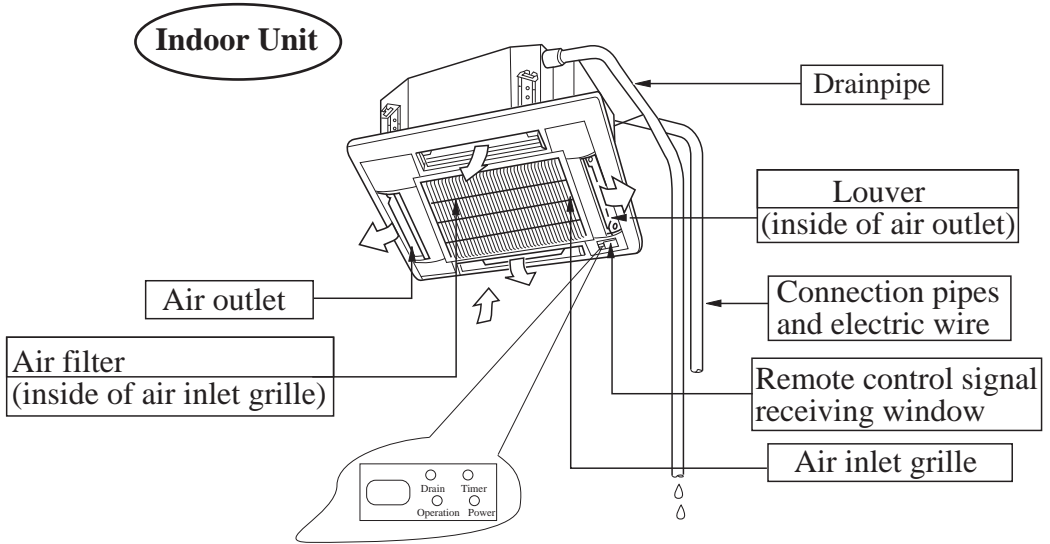

Wire Controller

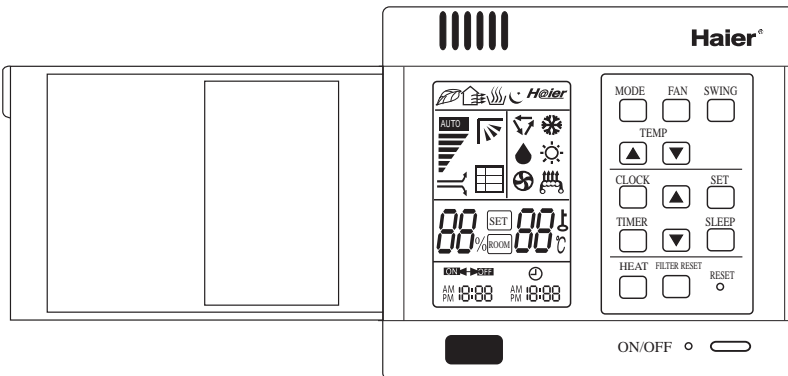

Name of Parts

Wire Controller

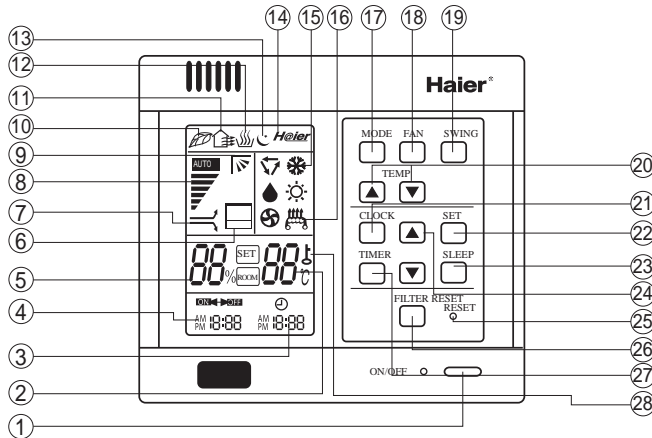

- 1.ON/OFF button
- 2.Temperature display
- 3.Clock display
- 4.Timer ON/OFF display
- 5.Humidity display
- 6.Air filter cleaning display

When there is too much dust collected on the air inlet, the wire controller will show this display to remind the user to clean the air inlet. After cleaning and installation, just press the air filter reset button.

- 7.Super/Soft operation display
- 8.Fan speed display



- 9.Auto Swing display
- 10.Health state display
- 11.Fresh air state display

- 12.Humidifying state display
- 13.Sleep state display
- 14.Network control display
- 15.Working mode display

Working mode	Auto operation	Cooling operation	Dehumidifying operation	Heating operation	Fan operation
Wire controller					

- 16.Electric heating display

- 17. Operation Mode button (Cooling, Dehumidifying, Heating, Fan)

- 18.Fan speed button
- Used to set fan speed: Low Fan, Med Fan, High Fan, Auto

- 19.Swing button
- Used to set Auto Swing or Fixed air sending direction

- 20.Temperature Setting button
- Used to set temperature, temperature range: 16*~30*

- 21.Clock button
- Used to calibrate the time of timer and clock
- 22.Setting button
- Used to confirm the time of timer and clock
- 23.Sleep button
- Used to set Sleep state or Power Failure Resume Function
- 24.Time Adjusting button
- Used to adjust the time of timer and clock

- 25.Reset button
- When the wire controller appears abnormal condition, use a sharp-pointed article to press this button to make the wire controller resume normal

- 26.Air Filter Reset button
- After cleaning the air inlet, press this button, the unit can start to operate

- 27.Timer button
- Used to set the mode of timer

- 28.Lock state display

Note:
This model does not have the following related display and function (⑩⑪⑫⑳)

Calibration of clock

When turning on the unit for the first time, the clock should be calibrated. The method of calibration is:

- 1.Press 'Clock' button, the Clock display 'AM' 'PM' will flash.
- 2.Press '*' or '*' to adjust time. For each press, the time will increase or*decrease 1 minute. If depressing the button, the time will increase or decrease*rapidly.
- 3.After confirming the time, press 'Set' button, 'AM' or 'PM' will stop flashing, the clock will begin to work.

Safety Precautions

Please read the following Safety Precautions carefully and use the air conditioner properly.

The following lists four kinds of safety precaution items and suggestions:

- ⚠ **Warning:** Improper use may cause death or serious injury.
- ⚠ **Notice:** Improper use may cause body hurt or unit damage; in some circumstance, it may cause serious results.
- ⊘ : Those contents marked with "Prohibition" are definitely prohibited action, otherwise, it may cause unit damage or risk to users' safety.
- ❗ : Those contents marked with "Forced" are definitely forced action, otherwise, it may cause unit damage or risk to users' safety.

The following safety precautions must be observed.

This safety precautions should keep in hand for reference.

When transfer the air conditioner to a new user, this manual should also be given to the new user together with the unit.

⚠ Warning

- If abnormal conditions (sear smell) occur, please stop the unit, turning off the electric power and contact the after-sales service center for solution.



- When needing repair, please ask the after-sales service work for help. Improper maintenance and repair may cause water leakage, electric shock and fire. ❗
- During the unit operation, do not insert fingers or other articles alike into the air inlet, outlet and louver. Because the high-speed fan is very dangerous, it may cause hurt.



- Ask after-sales service worker to take measure to prevent refrigerant from leaking. If the leaked refrigerant exceeds a certain density, it will cause lack of oxygen. If the room installed with air conditioner is too small, do take enough measure in order to avoid lack of oxygen even if refrigerant leaks. ❗
- When the air conditioner must be dismantled and reinstalled, please ask the after-sales service center to do this work. Improper installation may cause water leakage, electric shock and fire. ❗

Safety Precautions

⚠ Notice

- Do not use wet hands to operate the air conditioner. Otherwise, it may cause electric shock.



- Only use the proper specified fuse. Do not use cable or other materials to replace the fuse, otherwise it may cause fire and other trouble.



- Do not put the fire devices in the places, which the air from the air conditioner can directly blow. It may cause the fire devices cannot burn completely.



- Do not put or use any spray near the air conditioner, otherwise it may cause fire.



- Only after cutting off the power, can the cleaning of the air conditioner be performed to avoid leading to electric shock or injury.



- Do not use water to clean air conditioner, otherwise may cause electric shock.



- Connected with the grounding wire. The grounding wire shouldn't be connected with gas pipe, tap water pipe, lightning rod or telephone line. Improper grounding may cause electric shock accident.



- The drain hose should be arranged properly to have a smooth drainage. If the drain hose is not arranged properly, the leaked drain water may damage the furniture or other articles alike.

- Do not install the air conditioner in a place where the inflammable gas maybe exists. The inflammable gas around the air conditioner may cause fire accident.

- The Creepage breaker should be equipped.

- When using indoor smoky type pesticide, do not use air conditioner. Otherwise, it may cause the chemicals accumulate in the unit, result in doing harm to the people's health who is extremely sensitive to these chemicals.



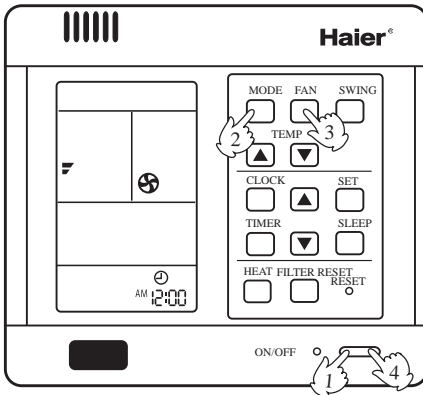

1 Turn on the unit

Press the ON/OFF button to turn on the unit. The LCD display of the wire controller will show the previous working state (except for Timer, Sleep, Swing mode), the operation indicator light on the wire controller will light up.

2 Choose of working mode

Press MODE button, each press the working mode will change as the following sequence:



choose FAN operation

3 Adjusting FAN SPEED

Press the FAN SPEED button to change fan speed:



Choose the desired fan speed

4 Turn off the unit

Press the ON/OFF button to turn off the unit. The wire controller only shows the clock and room temperature.

About FAN operation:

FAN operation refers the air conditioner does not perform COOLING and HEATING operation, but FAN operation. In this mode, the air conditioner cannot perform AUOT FAN operation, and does show the temperature value on the wire controller.

Operation instruction Auto/Cooling/Dehumidifying/Heating operation

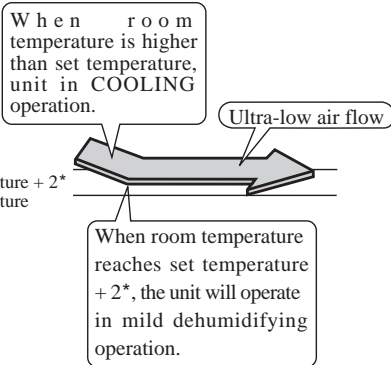
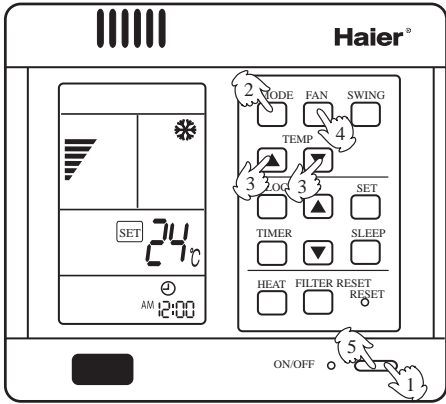

In Heating operation, after start the unit, the air conditioner will sending warm air a moment later to prevent the cold air blowing out. In Dehumidifying, when the room temperature drops 2* higher than the set temperature, regardless the set fan speed, the air conditioner will intermittently operate in low fan speed.

Hints:

The wire controller can memorize the working condition of each time. When start the unit for the second time, just need to press ON/OFF button, the air conditioner will work according to the previous working mode. (except for Timer, Sleep and Swing)

1 Turn on the unit
Press the ON/OFF button to turn on the unit. The LCD display of the wire controller will show the previous working state (except for TIMER, SWING, SLEEP mode). The operation indicator light on the wire controller will light up.

2 Choose of working mode
Press MODE button, each press the working mode will change as the following sequence:



then choose AUTO, COOLING, DEHUMIDIFYING, HEATING operation.

3 Set temperature
Press the TEMP. SET button
*Each press, the set temperature will increase 1 degree.
*Each press, the set temperature will decrease 1 degree.
Set the desired temperature.

4 Adjusting FAN SPEED
Press the FAN SPEED button, for each press, the fan speed will change as the following sequence:



Choose the desired fan speed.

5 Turn off the unit
Press the ON/OFF button to turn off the unit.
The wire controller only shows the clock and room temperature.

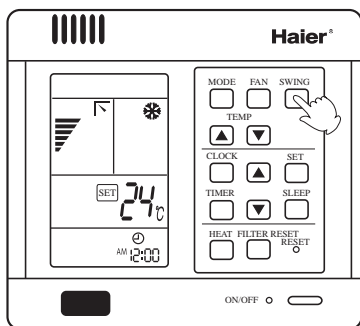

Auto swing

Press SWING button, the LCD of the remote controller display $\hat{\imath} \hat{\jmath} \hat{\imath}$, the louver of the air conditioner begins automatic swing and air sending.

Fixed air sending direction

When the Auto SWING of the air conditioner swings to an appropriate angle, press SWING button, the display $\hat{\imath} \hat{\jmath} \hat{\imath}$ on the LCD of the remote controller will disappear, the air sending direction is fixed.

When fixing the air sending direction, the louver should be kept in the following position:

In COOLING and DEHUMIDIFYING, it is better to be upward.

In HEATING, it is better to be downward.

- Always use the SWING button of the remote controller to adjust the louver. If adjust the louver manually, it may damage the louver.
- During COOLING and DEHUMIDIFYING, do not make the louver downwards for a long time. Because the vapor around the air outlet grille may be condensed and may have drop of water.
- When the infant, children, ages and the patients use the air conditioner, please pay attention to the set temperature.

- Before going to bed, you can press the SLEEP button, the air conditioner will operate in comfort sleep mode to make you have a sound sleep. Before using this function, you should calibrate the clock first, otherwise, the SLEEP function will be out of order.

Use of SLEEP function

After turning on the unit, setting the working mode, then press SLEEP button to make the air conditioner have the previous Sleep time (powered on for the first time or after performing Sleep is 1h). The Sleep symbol will appear. Press time */* button, you can choose between 1~8h. Each press, it may increase/decrease 1h and will display in the humidity area with ì xhî, and display ì Timer Offî in Timer Off area and the time to turn off; press Sleep button again to cancel Sleep function. The Sleep symbol disappears.

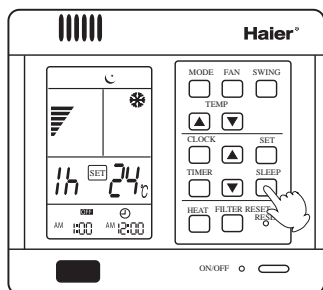
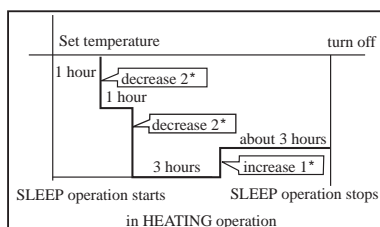
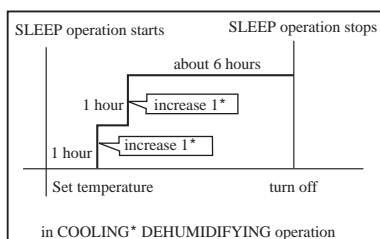

Operation modes

1.In COOLING, DEHUMIDIFYING operation

1 hour later in SLEEP operation, the temperature will increase 1* from the set temperature, another 1 hour later increase another 1*, then the unit will operate continuous for 6 hours, then it turns off automatically. The temperature is higher than set temperature to prevent you from getting a cold.

2.In HEATING operation

1 hour later in SLEEP operation, the temperature will decrease 2* from the set temperature, another 1 hour later increase another 2*, then the unit will operate continuous at this temperature for 3 hours, then it increases 1*, after operating at this temperature for another 3 hours, the unit will turn off automatically. The temperature is lower than set temperature to prevent you from feeling uncomfortable during sleep.

Note:

- After setting Sleep function, it is not permitted to adjust clock.
- The Sleep time is less than 8h, after reaching the set time, the unit will automatically stop.
- Set Sleep function after setting ì Timer Offî function, the air conditioner will perform Sleep function.
- After setting Sleep function, the Timer function cannot be set.
- Set Sleep function after setting ì Timer Onî function, the Sleep function can only be set in the set time of Timer On.

Before using TIMER function, calibrate the clock first.

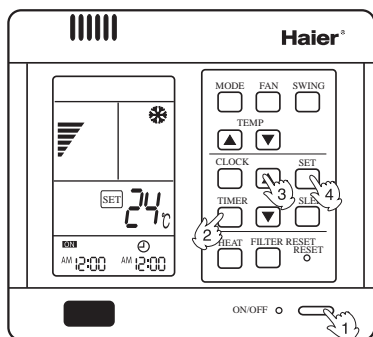

1. Turn on the unit

After turning on the unit, set the desired working mode.

The LCD will show working mode.

The power indicator light on the indoor unit will light up.

2. Set of TIMER mode

Press the TIMER button to change the TIMER mode, each press the TIMER mode will change as the following sequence:



Then choose the timer mode as need (TIMER ON or TIMER OFF.)

At this time the* **ON** or * **OFF** will flash.

3. Set time

Press the time adjusting button

- ▲ Each press, the set time increases 10 minutes. If depress the button, the time will increase rapidly.
- ▼ Each press, the set time decreases 10 minutes. If depress the button, the time will decrease rapidly.

This LCD will show the time set, the time can be adjusted within 24h.
(The minimum interval is 10 minutes).

AM stands for morning, PM stands for afternoon

4. Confirm the time

After calibration of the clock, press SET button to confirm time.

At this time, the* **ON** or* **OFF** will not flash.

The time displayed is: at x o'clock x minutes the unit will be turned on (TIMER ON) or turned off (TIMER OFF).

5. Cancel TIMER

Press the TIMER button several times until the TIMER mode display disappears.

Hints:.

After power failure, the clock should be calibrated again.

The remote controller has memory function, when you use this function for the second time, if the time set is the same as the previous one, you just need to choose the TIMER mode then press the SET button to confirm.

Before using TIMER function, calibrate the clock first.

1. Turn on the unit

After turning on the unit, set the desired working mode.

The LCD will show working mode.

The power indicator light on the indoor unit will light up.

2. Set of TIMER mode

Press the TIMER button to change the TIMER mode, each press the TIMER mode will change as the following sequence:



Then confirm the Timer mode is the **TIMER ON-OFF** mode.

At this time the * **ON** will flash.*

3. Set the TIMER ON time

Press the time adjusting button

* Each press, the set time increases 10 minutes. If depress the button, the time will increase rapidly.

*Each press, the set time decreases 10 minutes. If depress the button, the time will decrease rapidly.

This LCD will show the time set, the time can be adjusted within 24h.

* AM stands for morning, PM stands for afternoon *

4. Confirm the time

After adjusting time, press SET button to confirm time.

At this time, the * **ON** will not flash, * **OFF** begins to flash.

The time displayed is: at x o'clock x minutes the unit will be turned on.

5. Set the TIMER OFF time

Press the TIME button, the adjustment method is the same as the one of setting TIMER ON time.

6. Confirm the time of TIMER OFF

After adjusting time, press SET button to confirm time.

At this time, the * **OFF** will not flash.

The time displayed is: at x o'clock x minutes the unit will be turned off.

- **Cancel TIMER:** Press the TIMER button several times until the TIMER mode display disappears.
- According to the sequence of TIMER ON & TIMER OFF setting, you can realize turning on unit first, then turning off unit.

Users' Attention

- **Set proper room temperature**

Not too low or high and make every people in the room feel comfortable.



- **Do not let the cold air blows directly to human body for a long time and do not make the room temperature drop too low.**

Otherwise, it may cause uncomfortable or bad to your health.



- **The airflow cannot directly blow to the pets and plants.**

Otherwise, pets and plants may be hurt.



- **The room should often ventilate.**

After a long-time of using air conditioner, the room must be ventilated.



- **Do not keep the doors and windows open**

Otherwise, it may lower the efficiency of the air conditioner.



- **Television, radio and acoustics, etc. equipment should keep over 1m from indoor unit and wire controller.**

Otherwise, they may disturb the image and cause noise.



- **Do not put any drying devices under the indoor unit.**

The heat may cause the deformation of indoor unit.



- **If do not use the air conditioner for a long time, it is necessary to cut off power.**

If do not cut off power, the

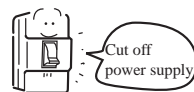

unit may consume

power. In order to protect the unit, before using the air conditioner again, turning on the power at least 12 hours in advance.

- **The windows should be hung with curtains or blinds.**

Do not let the sun shine directly shine in the room; do not let the outdoor air enter room.



- **The articles must keep dry cannot be put under the indoor unit.**

When the humidity is over 80% or the drainage outlet is blocked, the indoor unit may drop water.



- **Do not put articles around the air inlet and outlet.**

This kind of obstacle can lower the efficiency of the air conditioner or cause unit trouble.



- **The air conditioner can only be used in air conditioning. It can not be used in other purpose.**

Do not use the air conditioner in some specific purpose, such as storage or protect food, animals, plants, precise instrument and artwork, otherwise, the quality of them may be declined.



Maintenance

⚠ Notice

- The repair can only be performed by the professional workers.
- Before touch the wire connection device, cut off the power first.

⚠ Notice

- Only after turning off the unit and cutting off the power can the cleaning of the unit be performed. Otherwise, it may cause electric shock or injury.
- Do not use water to clean the air conditioner. Otherwise, it may cause electric shock.



- Use stable stand support. Please pay high attention when cleaning the unit

Daily maintenance

Clean the air filter

Instructions:

- When not for cleaning, do not dismantle the air filter, otherwise it may cause trouble.
- When the air conditioner is used in a dusty environment, the air filter should be cleaned more often (generally once every two weeks).

1. Open air inlet grille

Pull the two handles at the same time, slowly draw them out. (when closing it, the procedure is reversed.)

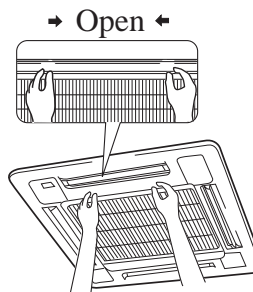

Clean the air filter

2. Dismantle the air filter

- Pull the two side handles at the back of the air inlet grille, lift the air filter to dismantle it.

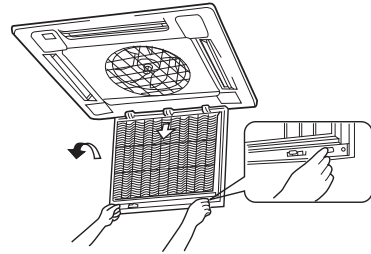

⇨ Open and remove ⇨

3. Clean

⚠ Notice

- Do not use the hot water over 50* to clean to avoid discoloration or deformation.
- Do not dry the unit on fire, the filter may be burnt.

Use cleaner or water to clean to remove dust.

A Use cleaner to remove dust.

B When the dust is too much, use soft brush and neutral detergent.



C Throw the water off, then put it in the shadow for airing.

4. Install air filter

- (1) Put the air filter into those extruding parts at the top of the air inlet grille.
- (2) Draw the handles at the back of the air inlet grille inwards to fix the air filter.

5. Close air inlet grille

Referring to procedure 1.

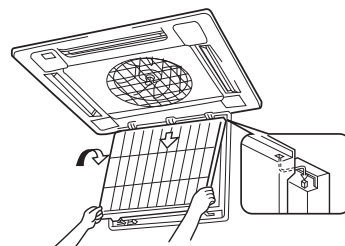

Maintenance

Clean the air inlet grille

1. Open air inlet grille

Pull the two handles at the same time, slowly draw them out. (when closing it, the procedure is reversed.)

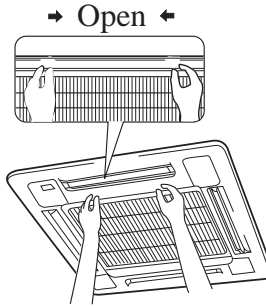

2. Remove air filter

Referring to 'Clean the air filter'.

3. Remove the air inlet grille

Open the air inlet grille for 450, the lift it up.

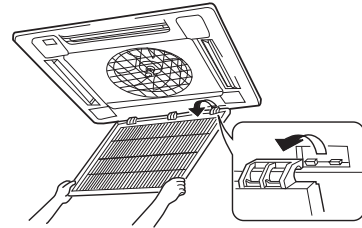

4. Clean

⚠ Notice

- Do not use the hot water over 50* to clean to avoid discoloration or deformation.

Use soft brush, water and neutral detergent to clean, then throw the water off.



Instruction

When there is too much dust

- Use ventilation fan or directly spray the detergent special for kitchen ware on the air inlet grille, 10 minutes later use water to clean.

5. Install air inlet grille

Referring to procedure 3.

6. Install the air filter

Referring to 'Clean the air filter'

7. Close air inlet grille

Referring to procedure 1.

Maintenance

Clean the air outlet and casing

⚠ Notice

- Do not use gasoline, benzene, diluent, polish powder or liquid pesticide to clean.
 - Do not use the hot water over 50* to clean to avoid discoloration or deformation.
- Use soft dry cloth to clean.
 - If cannot remove the dust, use water or neutral detergent.
 - If the louver of the air conditioner is too dirty, it may be dismantled (as the following described) for cleaning.

Dismantle and install louver

1. Fix the louver at the lowest position.

Referring to SWING operation.

2. Dismantle louver

⚠ Notice

- When use water to clean the louver, do not clean it to hard, otherwise the fuzz on the surface maybe fall off.

Loosen the screws at the two ends of the louver.

3. Install louver

Slightly rotate the louver, the extruding edges at the ends of the air inlet can be inserted into the louver groove, then tighten the screws.

Instruction

For details, please consult the after-sales service worker.

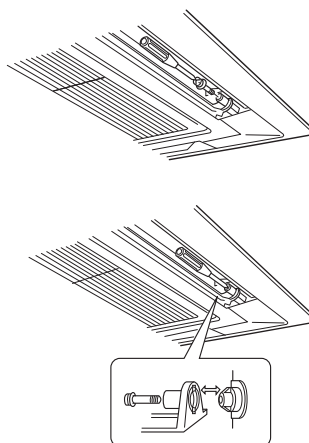

Maintenance before and after the using season.

Before using season

- 1. Check the following items:**
 - If the air inlet and outlet of indoor and outdoor unit are blocked.
 - If the earth wire is proper.
 - If the wire connection is proper.
 - If there is abnormal phenomenon, please ask the after-sale service staffs for help.
- 2. Cleaning the air filter or air inlet and casing**
 - After cleaning the air filter, it must be reinstalled.
- 3. Turn on the power**

After using season

- 1. In a sunny day, perform half-a-day Fan operation to make the inner of the unit dry.**
- 2. Cut off the power**
 - If do not cut off power, the unit will consume power. Power cutoff can save power.
- 3. Cleaning the air filter or air inlet and casing**
 - After cleaning the air filter, it must be reinstalled.
For the details of cleaning, please refer to Maintenance.

Troubleshooting

The following phenomena are not troubles

Symptom		Cause
The unit does not work	Immediately operate the unit after its stop.	3 minutes later, the unit will automatically operate.
The unit blows out mist.	In COOLING operation, when the ambient humidity is too high. (the content of oil or dust is too much in the room.)	When the inner of the indoor unit is not clean, the temperature fluctuation may occur.
	After finishing DEFROSTING, the HEATING operation starts.	The removed frost rises in vapor state.
The unit gives out noise	In COOLING or DEFROSTING, there is continuous 'Si, Si' noise.	This is the refrigerant gas flowing sound in the air conditioner.
	When the unit is started, stopped and when DEFROSTING starts or stops, there is the 'Si, Si' sound.	It is generated when the refrigerant stops flow or changes flow.
	In operation or after operation, there is a continuous 'Si, Si' sound.	It is the operation sound of the drainage system. (in COOLING operation, the drainage system drains in indoor side.)
	In operation or after operation, a 'GaZhi' sound is generated.	Because of the temperature change, It is caused by the hot expansion and cold shrink of the resin parts.
The unit blows out dust	After a long-time out of use, the unit is started.	The dust in the indoor unit assembly is blown out.
The unit gives out smells.	In operation.	The smells or the cigarette smell absorbed in indoor unit are blown out.
In DEHUMIDIFYING, no air sent out or cannot change the fan speed.	In DEHUMIDIFYING operation, when the room temperature is 2* higher than the set temperature, despite of the set FAN SPEED the air conditioner will operate in LOW FAN SPEED.	

When Troubles Occur

Before contacting the commissioned repair center for after-sales service, please check your air conditioner according to the following items.

Symptom	Cause	Solution
The unit does not operate.	The fuse is blown out or the breaker is open.	Change the fuse or close the breaker.
Once the unit operates, it stops immediately.	The air inlet or air outlet of indoor or outdoor unit is blocked.	Remove the obstacles.
Abnormal of COOLING or HEATING.	The air inlet or air outlet of indoor or outdoor unit is blocked.	Remove the obstacles.
	Improper set temperature	Referring to page 8
	The fan speed is set too low	Referring to page 8
	Incorrect swing direction	Referring to page 9
	The doors or windows are open	Close them
	·COOLING· Direct sunshine	Hang the curtain or blinds before windows
	·COOLING· Too much people in room	
·COOLING· Too many heat sources in room		

Trouble display

Phenomenon of outdoor unit trouble	The flashing time of indicator light on outdoor control panel
The trouble of outdoor ambient temperature sensor	1 (A, B systems indicate together)
The trouble of outdoor coil temperature sensor	2 (A and B system indicate individually)
The trouble of outdoor discharging air temperature sensor	3 (A and B system indicate individually)
The outdoor discharging air temperature is too high	4 (A and B system indicate individually)
Over electric current protection	5 (A and B system indicate individually)
CT wire breaks	6 (A and B system indicate individually)
Detection of abnormal phase sequence	7 (A and B system indicate together)
The communication trouble between indoor and outdoor unit	8 (A and B system indicate individually)
The protection of too high (too low) pressure	9 (A and B system indicate individually)
Phenomenon of indoor unit trouble	Trouble indication on remote control type indoor unit
The trouble of indoor ambient temperature sensor	The compressor indicator light flashes 1 time in 0.2S/time frequency
The trouble of indoor coil temperature sensor	The compressor indicator light flashes 2 time in 0.2S/time frequency
The trouble of outdoor ambient temperature sensor	The compressor indicator light flashes 3 time in 0.2S/time frequency
The trouble of outdoor coil temperature sensor	The compressor indicator light flashes 4 time in 0.2S/time frequency
The trouble of electric current overload	The compressor indicator light flashes 5 time in 0.2S/time frequency
Over voltage protection	The compressor indicator light flashes 6 time in 0.2S/time frequency
Excessive and lack voltage protection	The compressor indicator light flashes 7 time in 0.2S/time frequency
The communication trouble between panel and indoor panel	The compressor indicator light flashes 8 time in 0.2S/time frequency
The communication trouble between indoor panel and outdoor panel	The compressor indicator light flashes 9 time in 0.2S/time frequency
The trouble of water pump	The compressor indicator light flashes 10 time in 0.2S/time frequency

Installation instruction

- Before installing, do read this "Safety precautions" carefully to guarantee the proper installation.
- The below attentive matters are divided into "Warning" and "Note" two parts. When the wrong installation occur, it is very possible death and severe injury and other serious accidents will happen. For those items are listed in "Warning" part. But even the items listed in "Note" part can also cause serious accidents. Above all, both the two parts are very important contents related to safety, so they must be obeyed.
- After finishing the installation work, do test run to verify everything is normal. After that please explain the using and maintenance methods to the user. Additionally, give this installation manual and operation manual to the user and ask them to keep it properly.

Warning

- The commissioned repair center shall do the installation work. If you do the installation work by yourself, the improper installation will cause water leakage, electric shock fire and other accidents.
- The installation work shall be in line with what the installation manual specified. If installation is not proper, water leakage, electric shock, fire and other accidents will occur.
- Install the air conditioner to a place where can definitely stand its weight. The air conditioner can not be installed on a nonmetal bracket (such as theft guard net). Places not firm enough will cause drop down of unit resulting in body hurt.
- The installation work shall be preventive to typhoon and earthquake. If the installation work is not met with the requirements, overturn of the unit will occur resulting in accidents.
- Using the specified cable to do wiring work and connecting firmly and properly. Fix the connecting part of the terminals to prevent it from the external force. Improper connection and fixing will cause heating and fire etc. accidents.
- Wiring shall be kept in correct shape avoiding extrusion. After installation, the electric box cover and the external panel shall not nip the wire. Improper installation will cause heating and fire etc. accidents.
- When setting or moving the air conditioner do not let the air and things alike get into the refrigeration system except the specified refrigerant (R22). If air and other things enter, abnormal high pressure will occur, which easily cause break and body injuries etc. accidents.
- When installing, do use the accessories or specified parts. If not using the parts specified by our company, water leakage, electric shock, fire and refrigerant leakage will occur.
- Do not lead the drain hose to drain where the sulfur gas may be involved. Otherwise, the poisonous gas will enter into the indoor.
- During installation, if refrigerant leakage occurs, do the ventilation work immediately. As soon as the refrigerant gas meets fire, poisonous gas will be produce.
- After installation, confirm there is no leakage of refrigerant. If the refrigerant gas enters into room and meet the air blowing heater, heater or stove etc. fire source, the poisonous gas may be produced.
- Do not install the unit in a place where the combustible gas may be leaked. In any case the combustible gas leaks and accumulated around the unit, fire accident will occur.
- The drain hose should be correctly installed according to the installation manual to ensure smooth drainage, and take proper heat preservation measure to prevent from dew. Improper pipe installation may cause water leakage result in wet the indoor articles.
- Do heat insulation work to the refrigerant gas pipes and liquid pipes to reach the purpose of heat preservation. If the heat insulation measure is not sufficient, water generated by condensing dew will drip leading to wet the floor and indoor articles.

Note

- Do grounding work. Do not connect the grounding wire to gas pipe, tap, lighting rod or telephone line. Improper grounding will cause electric shock.
- In some places the creepage breaker shall be installed. If do not install the breaker, electric shock may occur.
- After electric installation, power on them to do electric leakage test.

Installation instruction

⚠ Notice

This manual can not include all kinds of conditions, if you have new requirements and questions, please contact with local Haier Sales Center.

⚠ Warning







Before installing the unit, please read this manual carefully. Improper installation may cause accidents and make unit damage or death.





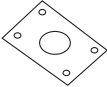



Installation tools

- | | | |
|-------------------------------|---------------------------------|----------------------------|
| 1. Screwdriver | 2. Steel saw | 3. 60, 70mm diameter drill |
| 4. Spanner (diameter 17,27mm) | 5. Spanner (14, 17, 19, 27mm) | |
| 6. Pipe cutter | 7. Pipe flarer | 8. Knife |
| 9. Pincers | 10. Leakage detector/soap water | |
| 11. Tape measure | 12. Scraper | 13. Refrigerant oil |

Accessories attached with the unit

The following is the manual mentioned standard accessories, please check them by yourself. As the following figure shown

No.	①	②	③	④	⑤	⑥
Shape & name	Wire controller (signal wire) 	Signal wire 	Installation paper panel 	Little wire clamp 	Big wire clamp 	Thermal insulation pipe 
Amount	1	1	1	6	2	2

No.	⑦	⑧	⑨	⑩	⑪	⑫	⑬	⑭
Shape & name	Drain hose 	Seal cushion 	Gasket 	Buckle 	Screw 	Plastic 	Refrigerant oil 	Cement steel nail 
Amount	1	4	8	1	3	6	1	12

1. Before installation [Before finishing installation, do not throw the attached parts installation needs]

- Confirm the way to move the unit to the installation place.
- Before moving the unit to the installation place, do not remove their packages. When have to remove the package, use a soft material or protection board with rope to lift the unit assembly to avoid unit damage or bumping a scrape.

2. Choose installation place

(1)The chosen installation place should meet the following requirements and get the user's consent.

Place ensures ideal airflow distribution.

The passage of airflow has no obstacles.

The condensate water can be drained smoothly.

Place can stand the weight of indoor unit.

Place ensures enough space for maintenance.

The pipe length between indoor and outdoor unit is in the permitted limit (referring to outdoor unit installation part).

The indoor unit, outdoor unit, electric wire and connection wire is at least 1m away from television and radio. This is to avoid the image disturbance and noise caused by the above-mentioned home appliance. (Even if 1m away, if the electromagnetic wave is too strong, it can also cause noise.)

(2)The height of ceiling

The indoor unit can install on the ceiling, which height is no more than 2.7m.

(3)Install and use the hoisting screw. Check if the installation place can bear the weight of unit assembly. If not certain, strengthen it before install the unit. (The installation gaps are marked on the installation paper panel. Refer to the paper panel to find those points needing to be strengthened.)

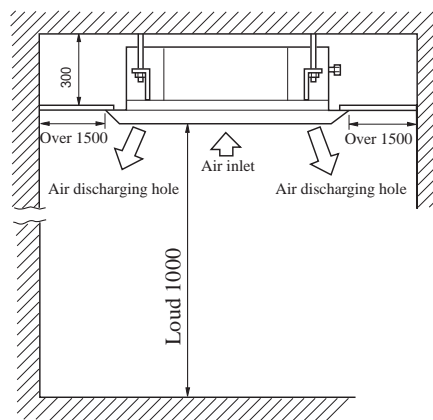

Space installation needed (unit: mm)

3.Preparation before installation

(1) The position relation among ceiling opening and hoisting screws (unit: mm)

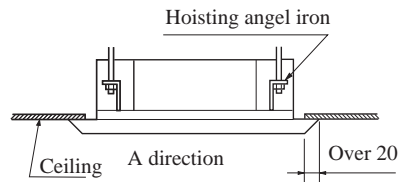
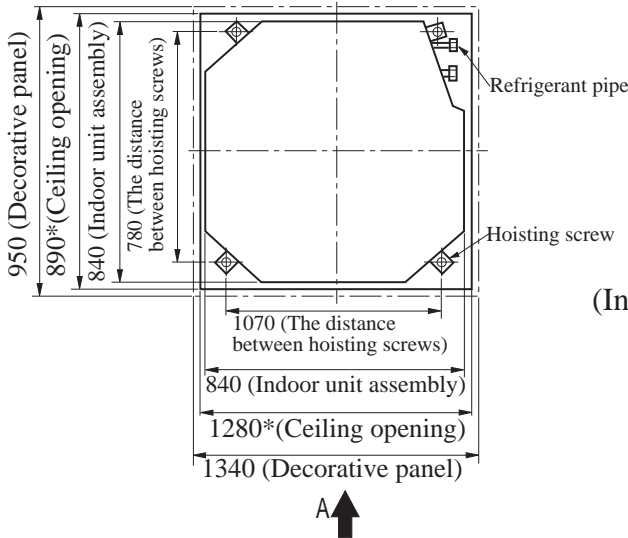

(Instruction)

The dimension of the ceiling opening with the mark of * can reach 910mm, but the overlap part between ceiling and decorative panel should keep over 20mm.

(2) If necessary, cut the opening installation needed in the ceiling.

(For the condition of having ceiling)

For the dimension of the ceiling opening, please refer to the installation paper panel.

Before installing the unit, finish the work of all the pipes (refrigerant pipe, drain hose) and wire (connection wire of indoor and outdoor unit) connected with indoor unit to make it is possible after installation, they may connect with the indoor unit immediately.

If cutting a opening in the ceiling, maybe the ceiling needs to be strengthened to guarantee its evenness and prevent the ceiling from vibration. For details, please consult to the builder.

(3) Install the hoisting screw (use a M10 screw)

(The using specification of hoisting screw is M8, but when the height of hoisting screw is more than 1.0m, the hoisting screw with the specification of M10 must be used).

In order to bear the weight of the unit, for the original ceiling circumstance, use foot screw; for the new ceiling circumstance, use built-in screw, embedded screw or the parts provided on site. Before continuing installation, adjust the gap between the unit and the ceiling.

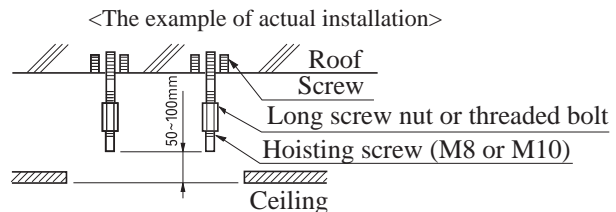

4. Installation of indoor unit

In the new ceiling circumstance

- (1) Temporarily install the indoor unit
 - Attach the hoisting foot on the hoisting screw. The screw nut and washer must be used at the top and bottom two ends of the hoisting foot to make the hoisting foot firm.
- (2) For the dimension of the ceiling, please refer to the installation paper panel.
 - There is the mark of the ceiling opening's center on the installation paper panel.
 - There are marks of the unit center in both the label attached on the unit and the installation paper panel.
 - Use screws to fix the installation paper panel on the unit, and use screws to fix the corners of the drain pan at the end of the pipe outlet.

After finishing installation of the ceiling

- (3) Adjust the unit to the correct installation position.
- (4) Check if the unit is level

The indoor unit is equipped with internal drainage pump and float switch. Use water level or the polyethylene pipe charged with water to respectively check if the four corners of the unit are level. (If the unit is slant toward the opposite direction of the condensate water flow, the float switch may have trouble leading to water leakage.)
- (5) Fasten the screw nuts on the washer.
- (6) Dismantle the installation paper panel.

In the original ceiling circumstance

- (1) Temporarily install the indoor unit

Attach the hoisting foot on the hoisting screw. The screw nut and washer must be used at the top and bottom two ends of the hoisting foot to make the hoisting foot firm.
- (2) Adjust the height and the position of the unit.
- (3) Perform the step (4) and (5) in the procedure of ④ in the new ceiling circumstance.

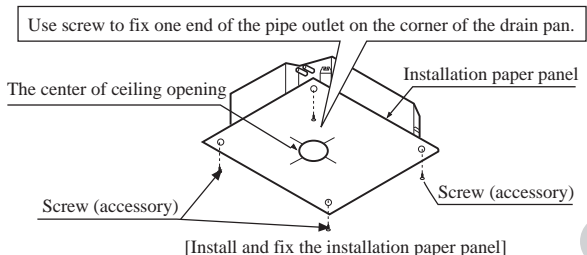
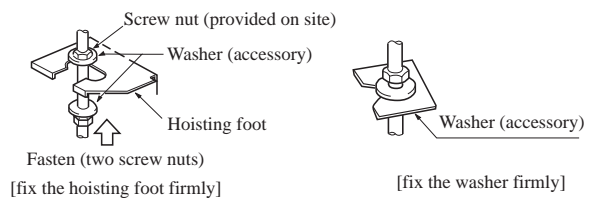
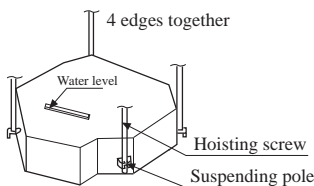

5.Refrigerant pipe

[The proper thermal insulation must be treated to gas pipe and liquid pipe. If not, it may cause water leakage.]

- The outdoor unit is not charged with refrigerant.
- When connecting the pipes to unit or dismantling the pipes from the unit, do proceed as the figure shown, use spanner and torque pincers together.
- For the dimension of the cone-shaped screw nut, please referring to Table 1.
- When connecting pipes, both the inner or the outside of the cone-shaped screw nut should be pasted with refrigerant oil. Use hands to twist it for 3~4 circles, then tighten it.
- According to Table 1 to confirm the fasten torque. (fasten too tight may damage the screw nut leading to leakage)
- After check if the connection pipes leaks, then perform thermal insulation treatment, as the following figure shown.
- Only use seal cushion to bind the joint between gas pipe and the insulation parts.

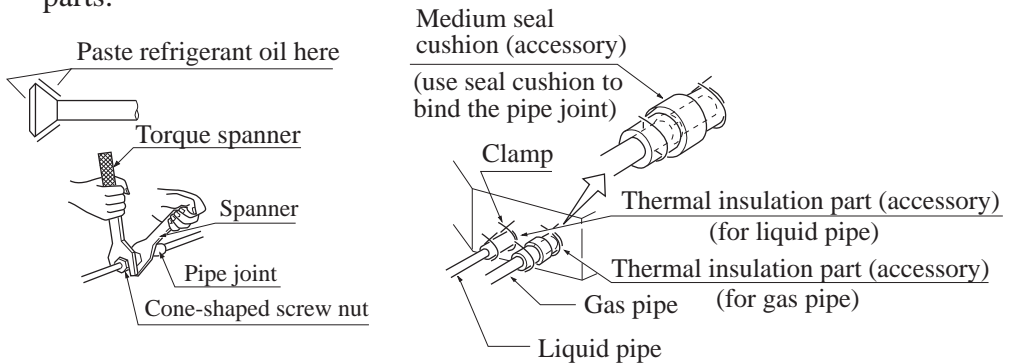

Specification of pipe (mm)	Torque	Dimension of cone A (mm)	Cone
*9.52	3270~3990 Ncm (333~407 kgf*cm)	12.0~12.4	
*15.88	9720~11860 Ncm (990~1210 kg*fc)	18.6~19.0	

6.Installation of drain hose

(1)Install the drain hose

The diameter of the drain hose should be larger than or equal to the diameter of connection pipe.

(Polyethylene pipe, dimension: 25mm, external diameter:32mm)

Installation procedure

Install indoor unit

- The drain hose should be as short as possible. The droop slant degree at least should be $1/100$ to avoid forming of gas bag.
- If cannot make the drain hose have an enough slant degree, a drainage enhancing hose should be equipped.
- In order not to let the drain hose bend, a 1~1.5m distance should be kept between suspending frame.

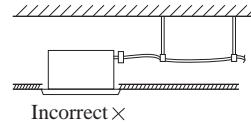
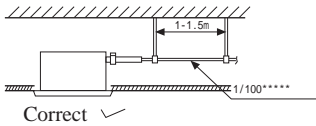

- Use drain hose (accessory) and buckle (accessory).
Insert the drain hose into the drainage interface till the white adhesive tape part. Tighten the buckle tight.
- In order to thermal insulated, use seal cushion to bind the drain hose.
- Do thermal insulation to the indoor drain hose.

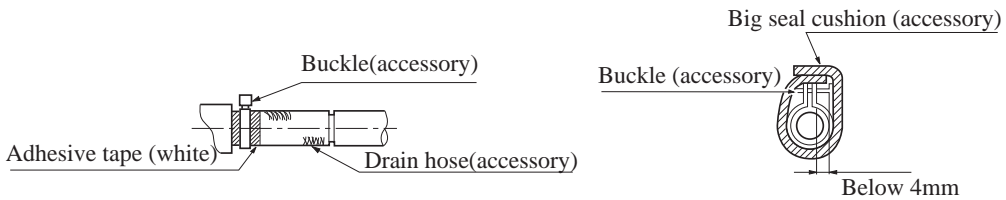

<The attentive matters of drainage enhancing pipe>

The installation height of the drainage enhancing pipe should be less than 280mm.

The drainage enhancing pipe should be vertical to the unit and no more than 300mm away from the unit.

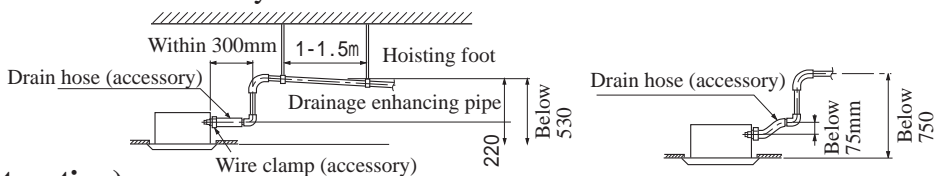

Instruction)

- The slant of the accessory drain hose should be within 75mm to make the drain faucet not bear too much excessive external force.
- If many drain hoses join together, please install according to the following procedure.



The specification of the chosen joined drain hoses should be applicable to the operation capacity of the unit.

Test of drainage system

- (a) After finishing the electric work, perform the test to the drainage system.
- (b) During test, confirm the water flow properly passes the hose and there is no leakage at the joint.
- (c) If the house is new, perform test before installing ceiling.
- (d) Even if installing in the season needing to make heating, the test also must be performed.

Procedure

- (a) Through the air outlet and use water pump to provide the equipment with about 1000cc water.
- (b) In COOLING operation, check the drainage system.

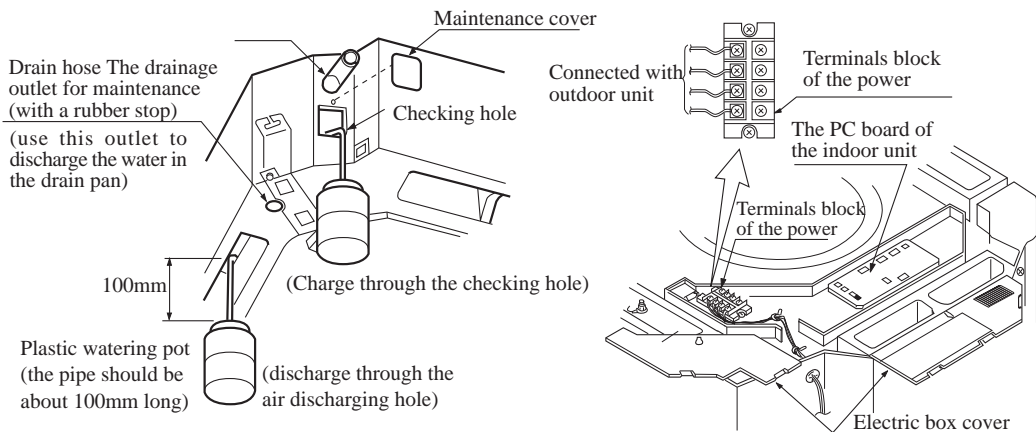

7. Electric circuit

- All the provided parts, material and electric work should be complied with the local regulation.
- Must use cooper core cable.
- When performing electric work, please refer to the wiring diagram on the unit.
- All the wiring work should be done by the qualified electrician.
- A breaker which can cut off the power of the whole circuit must be equipped.
- For the specification of the power cable connected with the outdoor unit, the capacity of breaker and switch and the guide of circuit, etc. please refer to the configuration of the power supply.

<The wiring method of the connection of the unit>

- Connect the unit
Remove the electric box cover (1), draw the wire in the rubber lining, use wire clamp A to clamp it together with other wires, and connect the wire of the relative polarity to the inner power terminal block.
After proper connection, press the wire clamp A tight.
- Bind the seal cushion on the wire. (it must be bound tight to avoid dew-forming)
- **After proper connection, reinstall the electric box cover (1).**

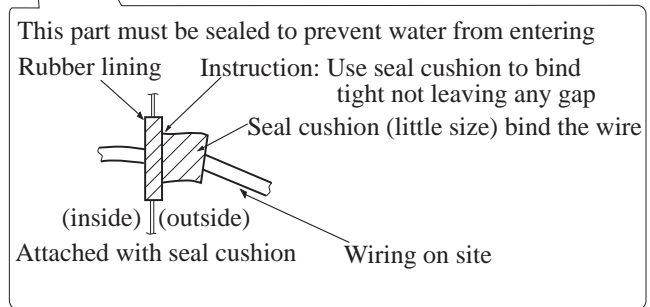
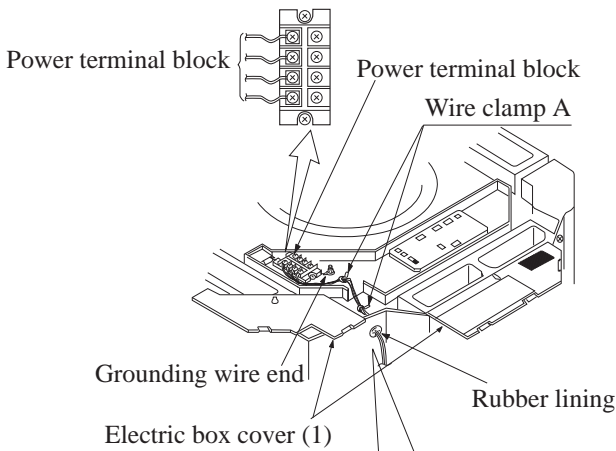

1. Preparation of decorative panel

The treatment of decorative panel

- The decorative panel cannot be put down with the front downwards, cannot lean on the wall and cannot be put on the extruding objects.
- Do not touch louver or force on it, otherwise the louver may have trouble.

(1) Dismantle the air inlet grille from the decorative panel

Pull the pole of the air inlet grille inwards, then lift one end of the pole (referring to Figure 1).

Lift the air inlet grille for about 45°, dismantle the air inlet grille from the decorative panel. Then tear off the adhesive tape to fixing the air filter on the back of the air inlet grille (referring to Figure 2).

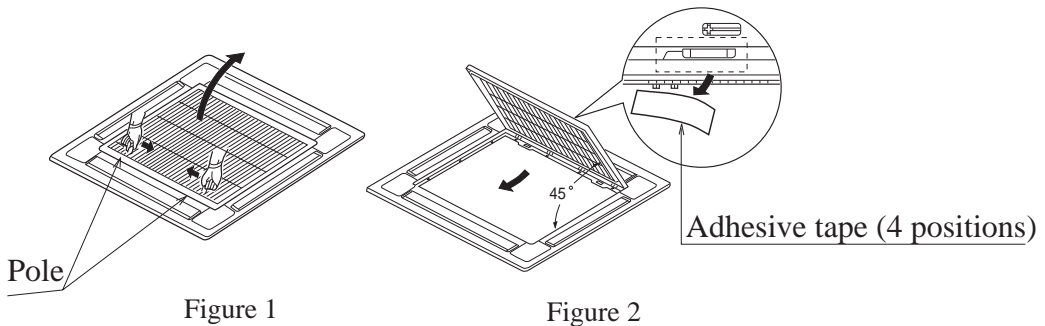

(2) Dismantle the corner cover

Tear off the fixing adhesive tape on the corner cover. When the corner cover can slide, dismantle the corner cover (referring to Figure 3).

Note: When the air conditioner is under use, the fixing adhesive tape can be removed, not use any longer.

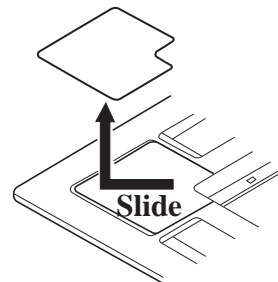

Figure 3

2. The installation of the decorative panel on the indoor unit.

As Figure 4 shown, make the position of the louver motor of the decorative panel and the position of nozzle of the indoor unit face to face, then install the decorative panel on the indoor unit.

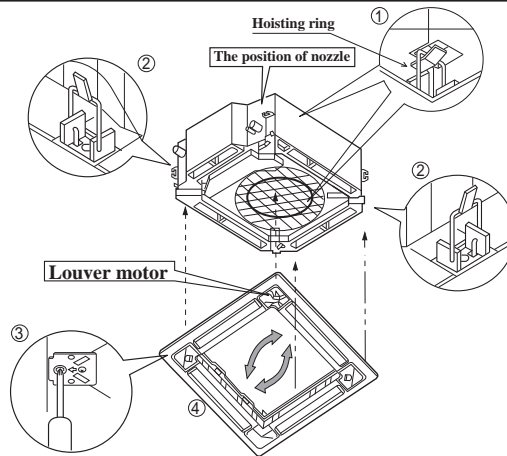
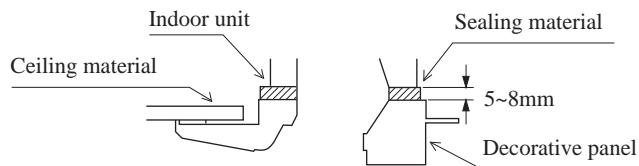

Figure 4

(1) Install decorative panel

- ① Temporarily hang the hoisting ring opposite to the louver motor of the decorative panel on the hoisting ring fixing piece (2 pieces) of the indoor unit.
- ② Temporarily hang the other 2 hoisting rings on the hoisting ring fixing pieces at the side of the indoor unit (be careful not to stick to wire of the louver motor into the sealing material).
- ③ Screw all the 4 hexagon screws under the hoisting ring into about 15mm (the decorative panel will rise).
- ④ Twist in the direction as Figure 4 shown, adjust the decorative panel to make it totally cover the ceiling opening.
- ⑤ Fasten the screw to make the thickness of the sealing material between decorative panel and the indoor unit compressed to 5~8mm.



Notice

If fastening the screws improperly, it may cause the trouble as Figure 5 shown. The screw should be fastened properly. If after fastening the screw, there still is gap between decorative panel and ceiling, please readjust the height of the indoor unit (referring to Figure 6). If the indoor unit keeps horizontal and the drain hose is not affected, adjust the height of the indoor unit through those holes at the corner of the decorative panel.

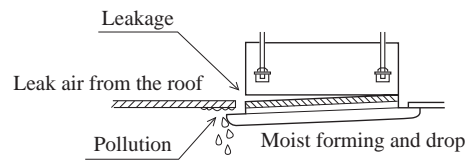

Figure 5

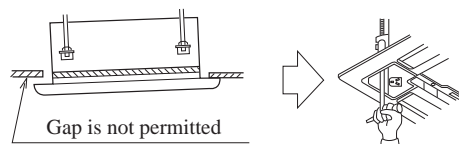
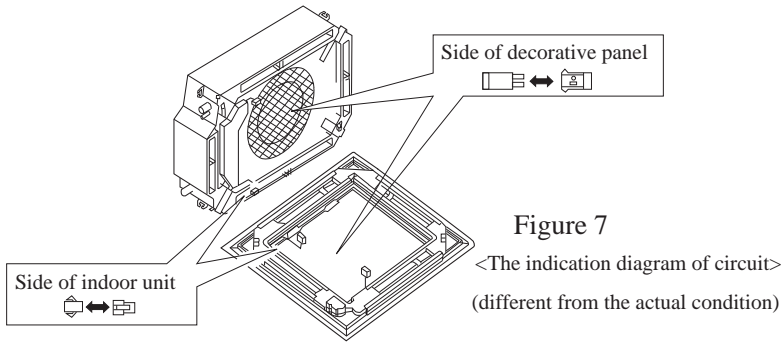

Figure 6

(3) The circuit of the decorative panel

- ⑥ Connect the wire end of the louver motor installed on the decorative panel (referring to Figure 7).
- ⑦ Connect the remote control receiving terminals installed on the decorative panel.



3. Installation of air inlet grille and corner cover

*(1) Install the air inlet grille

*The reversed procedure to the 'the preparation of decorative panel' part.*****

When installing the air inlet grille, be careful not to wrap the wire of the louver motor.

(2) Install the corner cover on the corner

**As Figure 8 shown, tie the rope of the corner cover on the cleat of the decorative panel.

***Install the corner cover on the decorative panel (referring to Figure 9).

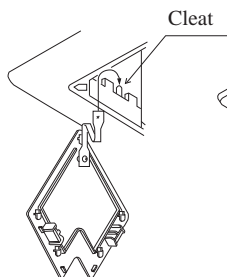

Figure 8

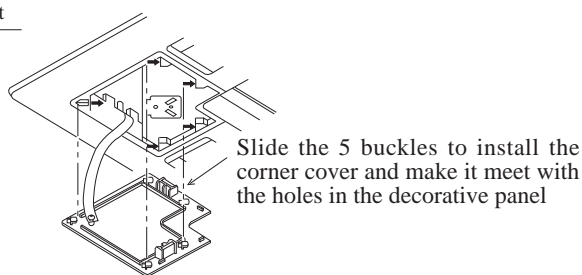

Figure 9

1. Connection of pipe

**The max length of connection pipe is 50m, the max fall is 30m.

The attentive matters in connection of pipe

- In order to guarantee the efficiency, the pipe should be as short as possible.
- Do not make the connection pipe distorted and deformed.
- Do not let dust enter into pipe.
- When bending the pipes, give the roundness as large as possible.
- Both gas pipe and liquid pipe should be thermal insulated.
- There should be no leakage at the flare parts.

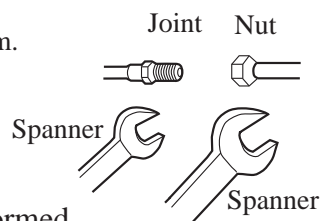

If do not fit the center and screw the nut hard, the screw thread may be damaged, which will cause refrigerant leakage.

Pipe diameter	Fasten torque
Liquid pipe \varnothing 9.52mm	32.7~39.9
Gas pipe \varnothing 19.05mm	97.2~118.6

** Connection method

***Daub the refrigerant oil on the joint and the flared nut.

***When bending the pipes, give the roundness as large as possible.

***To connect the pipe, fit the center and use hand to screw the nut, then use spanner to tighten the nut, as shown in figure.

***Pay attention not to let alien matters, such as sand, get into the pipe.

2. The additional charging amount of refrigerant

The additional charging of refrigerant (R407C) should be complied with the installation manual of outdoor unit. It must use measurer to quantificationally charge. The additional charging amount must be complied with the specified amount.

Requirements: Both excessive charging and less charging of refrigerant will cause the compressor trouble. It must be complied with the specified amount.

3. Vacuumizing

Use vacuum pump to vacuumize from the stop valve of the outdoor uin.

It is strictly prohibited to use the refrigerant sealed in the outdoor unit to perform air discharging.

4. Leakage detection

Use leakage detector or soap water to check if the connected part of the connection pipe and the valve cap leak.

5. Thermal insulation treatment

The thermal insulation of connection pipe should be performed at both gas side and liquid side. In COOLING, both liquid side and gas side are in low temperature, in order to prevent dew from forming, thermal insulation should be done.

The thermal insulation material at the gas side must use the material with the heat resistant temperature over 120*.

The connected parts of indoor unit connection pipe should be thermal insulated.

Wiring method

1. The wiring method of orbicular terminal

For the connection wire which end is orbicular terminal, its wiring method is as the right figure shown. Dismantle the screw and put it through the ring at the end of the connection wire, then connect it to the terminal block and tighten the screw.

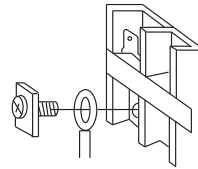

The wiring method of orbicular terminal

2. The wiring method of straight terminal

For those connection wires whose end are not orbicular terminals, their wiring method is:

Loosen the connecting screw, insert the end of the wire directly into the terminal block, and then tighten screw. Pull the wire outwards slightly to confirm it is held tightly.

3. Pressing method of connection wire:

After wiring, the connection wire must be pressed with wire holding clamp. The wire holding clamp should press on the out cover of the connection wire. As the right figure shown:

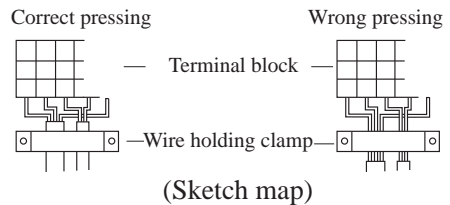

Connect wire between indoor & outdoor unit

- Remove the air inlet grille, open the electric box cover.
- Pull out the front end of the connection wire.
- Perform wiring according to the outdoor unit manual.
- Press the wire properly according to the pressing method of connection wire.
- Install the electric box cover and the air inlet grille properly.

Note:

When connecting the wire of indoor and outdoor unit, check the number on the indoor and outdoor terminal blocks, the same number uses one wire to connect. Incorrect wiring easily damage the controller of the air conditioner, or the unit cannot work normally.

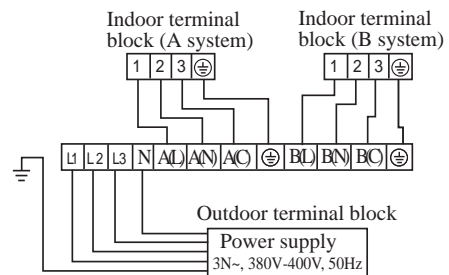

Installation procedure

Other instruction

1. Power supply

- The air conditioner must use a special power circuit and special air switch. The users should provide special switch, grounding wire by themselves. The wiring should be done by a qualified electrician according to the wiring rules specified by national standard
- An creepage breaker should be installed.
- The grounding wire and null wire of receptacle should be strictly separated. It is incorrect to connect the null wire with grounding wire.
- The connection method of power cord is Y connection. If the power cable is damaged, in order to avoid danger, it must be replaced by the manufacturer or its specified repair center of the same qualified worker.

2. Cut and flaring method

Use pipe cutter to cut the pipe, the burrs must be removed.
After inserting the flarer, perform flared nut.

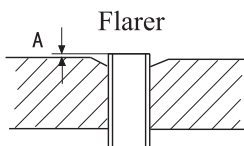

Flaring dimensions as follows:

Connent pipe	Pipe diameter	Dimension A (mm)
Liquid pipe	9.52mm (3/8")	1.0-1.2
Gas pipe	19.05mm (3/4")	1.4-2.2

Correct	Incorr				
	Slant	Broken	Burrs	Uncompleted	Too long

Test run

The following items must be noticed carefully during installation. After finishing installation, performing checking.

After installing the refrigerant pipe, drain hose and electric wire properly, perform test run to ensure the system not have trouble.

Perform test run before installing decorative panel

- (1) Open the stop valve of gas pipe.
- (2) Open the stop valve of liquid pipe.
- (3) Use remote controller to set to COOLING operation, press ON/OFF button to start operation.
- (4) After finishing operation, cut off the general power supply.

Perform test run after installing decorative panel

- (1) Open the stop valve of gas pipe.
- (2) Open the stop valve of liquid pipe.
- (3) Use remote controller to set to COOLING operation, press ON/OFF button to start operation.
- (4) Confirm the function of the unit according to the operation manual.

Note: The wiring diagram of this model is pasted inside of the unit.

Free Manuals Download Website

<http://myh66.com>

<http://usermanuals.us>

<http://www.somanuals.com>

<http://www.4manuals.cc>

<http://www.manual-lib.com>

<http://www.404manual.com>

<http://www.luxmanual.com>

<http://aubethermostatmanual.com>

Golf course search by state

<http://golfingnear.com>

Email search by domain

<http://emailbydomain.com>

Auto manuals search

<http://auto.somanuals.com>

TV manuals search

<http://tv.somanuals.com>