

Haier Network Air Conditioner

Two by One Room Air Conditioner

AD422BMBAA

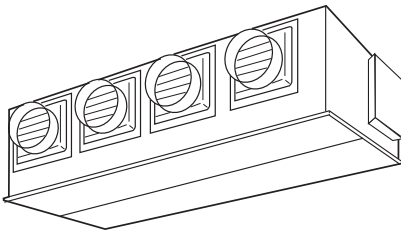

CONTENTS

Before Use

- Operation Points***** 1
- Name of Parts*****2-3
- Safety Precautions*****4-5

Operation Instruction

- Fan Operation*****
- Auto, Cooling, Dehumidifying,
Heating operation*****7
- Timer On/Off Function*****8
- Timer On-Off Function *****9
- Sleep Function*****10
- Users' Attention*****11

Maintenance

- Maintenance*****12-13
- Troubleshooting***** 14-16

Installation of Indoor Unit

- Installation Instruction*****17-18
- Installation Procedure *****19-29

No: 0010571812

- Please read this manual carefully before using
- Please keep this manual for future use

Characteristics of Products

Characteristics of Products

- 1.Prompt temperature adjustment.
- 2.Inner hidden type installation, space saving.
- 3.Large screen LCD display, easy and convenient operation.
- 4.Super quiet design.
- 5.Powerful circular air volume.
- 6.This air conditioner has POWER FAILURE RESUME FUNCTION. During the operation of the unit, if there is a sudden power failure, when the power resumes, the unit will resume the previous operation mode.
- 7.This unit has the function of far distance monitoring. Through the telephone network, it can be effectively controlled in any other far-distance place. (Only after equipped with the "far distance detector" made by our company can this function be fulfilled.)

Far distance monitoring

There is a pre-set far distance control communication interface on the control panel of indoor unit. After installing the peripheral equipment according to the manual attached with the Haier made far distance control detector, the computer management or other place monitoring can be achieved to the air conditioner.

Operation points

Operation of air conditioner

When the ambient humidity is too high, in COOLING or DEHUMIDIFYING mode, there may be water dropped in the air outlet.



Anti-cold air blowing out

During Heating operation, after starting the unit, the indoor fan motor will not rotate immediately to prevent cold air from blowing out.*

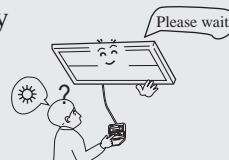

3-minute protection function

If start the unit immediately only after it is turned off, the compressor will start after 3 minutes have elapsed to protect the compressor.



Defrosting function

During Heating operation, when frost formed on the heat exchanger of outdoor unit, the air conditioner will defrost automatically for several minutes. During defrosting, both the fan of indoor and outdoor unit do not run. After finishing defrosting, the air conditioner will automatically resume operation.

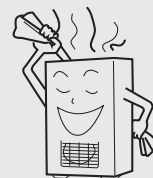

Change of fan speed

In COOLING mode, the air sending is set at AUTO, when the indoor temperature is near the set temperature, the fan speed will lower automatically. In HEATING mode, when room temperature reaches the set temperature, the compressor will stop running, and the fan will change to LOW FAN or stop. In DEHUMIDIFYING mode, the fan speed will change automatically.

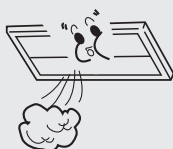

Hint

When the air conditioner is in Heating mode, it absorbs heat from outside and release to indoors. So the outdoor temperature may affect the Heating effect.

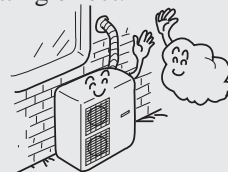

Power failure resume function (please set and use this function according to actual condition)

After setting power failure resume function, if there is a sudden power failure during unit operation, when power on for again, the unit will resume the previous state.

Setting method: when the wire controller is in ON state (except for TIMER and FAN mode), press the SLEEP button for 10 times in 5 seconds, after the buzzer sounds 4 times, the unit will change to POWER FAILURE RESUME function.

Cancellation method: press the SLEEP button 10 times in 5 seconds, after the buzzer 2 times, the POWER FAILURE RESUME function is cancelled.

Note: After the unit is set POWER FAILURE RESUME function, if there is a sudden power failure in using, during this period of time if there is no need to use the unit for a long time, please cut off power to prevent the air conditioner from automatically resuming to the previous setting if power failure resumes, or press the ON/OFF button to turn off the unit after power failure resumes.

Name of Parts

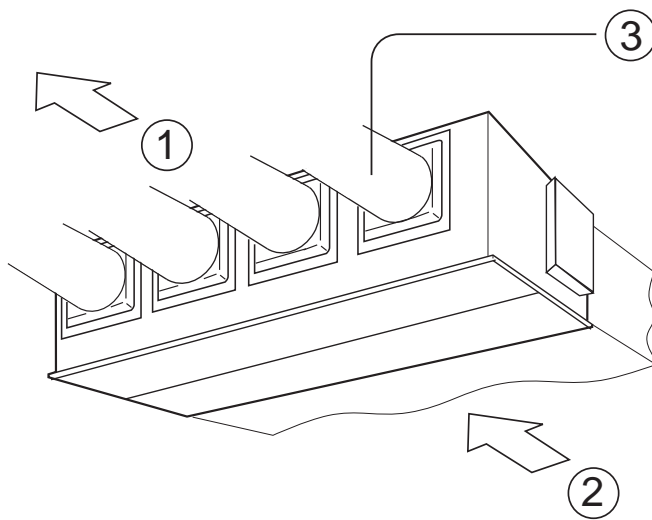

* Air outlet * Air inlet * Ventilation hole

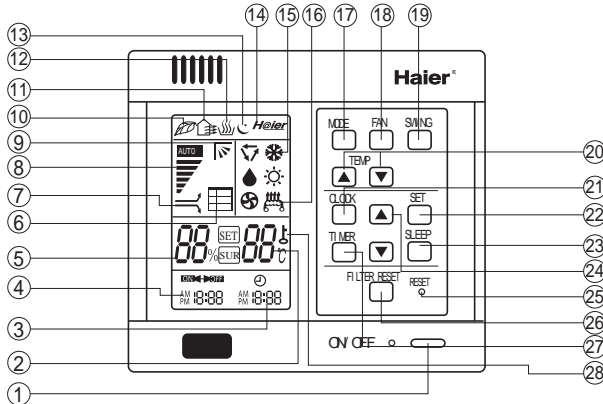

1.ON/OFF button

Used to turn on/off unit

2.Temperature display

3.Clock display

4.Timer ON/OFF display

5.Humidity display

6.Air filter cleaning display

When there is too much dust collected on the air inlet, the wire controller will show this display to remind the user to clean the air inlet. After cleaning and installation, just press the air filter reset button.

7.Super/Soft operation display

8.Fan speed display



9.Auto Swing display

10.Health state display

11.Fresh air state display

12.Humidifying state display

13.Sleep state display

14.Network control display

15.Working mode display

| Working mode | Auto operation | Cooling operation | Dehumidifying operation | Heating operation | Fan operation |
|-----------------|----------------|-------------------|-------------------------|-------------------|---------------|
| Wire controller | | | | | |

16.Electric heating display

17.Operation mode button

Used to set working mode: Auto, Cooling, Dehumidifying, Heating, Fan

18.Fan speed button

Used to set fan speed: Low Fan, Med Fan, High Fan, Auto

19.Swing button

Used to set Auto Swing or Fixed air sending direction

20.Temperature Setting button

Used to set temperature, temperature range: 16*~30*

21.Clock button

Used to calibrate the time of timer and clock

22.Setting button

Used to confirm the time of timer and clock

23.Sleep button

Used to set Sleep state

24.Time Adjusting button

Used to adjust the time of timer and clock

25.Reset button

When the wire controller appears abnormal condition, use a sharp-pointed article to press this button to make the wire controller resume normal

26.Air Filter Reset button

After cleaning the air inlet, press this button, the unit can start to operate

27.Timer button

Used to set the mode of timer

28.Lock state display

Note:

- This model does not have the following related display and function (9, 10, 11, 12, 16, 28)

Calibration of clock

When turning on the unit for the first time, the clock should be calibrated. The method of calibration is:

- Press 'Clock' button, the Clock display 'AM' 'PM' will flash.
- Press '*' or '*' to adjust time. For each press, the time will increase or*decrease 1*minute. If depressing the button, the time will increase or decrease*rapidly.
- After confirming the time, press 'Set' button, 'AM' or 'PM' will stop flashing,the clock will begin to work.

Safety Precautions

- Before starting the unit, please read the following 'Safety Precautions' carefully to guarantee the normal operation of the system.
- The following lists two kinds of safety precautions 'Warning' and 'Notice'. For the items that the improper use may cause death or serious injury are listed in 'Warning' volume. However, sometimes the items listed in 'Notice' volume may also cause serious accidents. So, these two volumes are the important contents related to safety, they must be observed.

| | | |
|---|---|--|
|  Do not do like this |  Do follow the instruction |  Do equip with grounding wire |
|---|---|--|

- After carefully reading this manual, please keep in hand for reference. If the air conditioner is given to a new user, this manual should be attached with unit to the new user.

■ Installation Safety Precautions

⚠ Warning

The system should be applied to places as office, restaurant, residence and the like.



Application to inferior environment such as workshop, it may cause equipment malfunction and serious injury or death.

The system should be installed by your dealer or a professional installer.



Installation by yourself is not encouraged. Because improper installation could cause water leakage, electric shock and fire accident.

⚠ Notice

A creepage breaker must be installed at the installation place.



Unless the circuit breaker is installed, it may cause electric shock.

Drain pipe should be arranged properly to provide a smooth drainage.



If the pipe is arranged improperly, furniture or the like may be damaged by the leaked water.

Make sure the system is grounded.



Grounding wire should never be connected to gas pipe, city water pipe, lightning conductor rod or the telephone line. If the grounding wire is not set properly, it may cause electric shock.

■ Operation safety precautions

⚠ Warning

Do not let the cold wind blow to human body for a long time.



It may affect the physical condition or cause some health problems.

When any abnormal condition (scorching smell or others) is found, stop operation immediately and turn off the power switch. Then consult your dealer.



If continuing the operation without removing the cause, it may cause trouble, electric shock or fire.

⚠ Notice

Do not handle switches with a wet hand.



It may cause electric shock.

Do not use water to clean the air conditioner.



It may cause electric shock.

Safety Precautions

⚠ Notice

The system should never be used for any other purposes than intended such as for preservation of food, flora and fauna, precision devices or work of art.



It may cause deterioration of the articles.

Do not put or use any spray near the air conditioner, and do not directly spray to the air conditioner.



Otherwise it may cause fire.

Do not put the fire devices in the places, which the air from the air conditioner can directly blow.



It may cause the fire devices cannot burn completely.

Do not install the system where the air outlet may directly reach the flora and fauna.



It will not be good for their health.

Only use the proper specified fuse.



If use metal wire or copper wire to replace the fuse, it may cause trouble and fire accident.

Do not use the power switch to turn of or off the air conditioner.

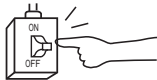

It may cause fire or Creepage.

When operating the system simultaneously with a combustion apparatus, indoor air must be ventilated frequently.*



Insufficient ventilation may cause the danger of lack of oxygen.

When cleaning, please stop the unit and cut off the power first.



Do not perform cleaning, when the indoor fan motor is rotating in high speed.

Do not use such equipment as a water heater, etc., around the indoor unit or the wire controller.



If the system is operated at the vicinity of such equipment that generates steam, condensed water may drip during cooling operation or it may cause Creepage or short-circuit.

Do not put the water containers, such as vase, on the unit.



If the water enters into the unit and damages the electric insulation material, it may cause electric shock.

■ Safety precautions when moving, reinstalling and repairing the air conditioner

⚠ Warning

Do not refit the air conditioner. When repair is needed, please contact your dealer.

Improper repair may cause water leakage, electric shock and fire accident.



When moving the air conditioner to another installation place, please contact the dealer or the professional installer.

Improper moving and reinstallation may cause water leakage, electric shock and fire accident.



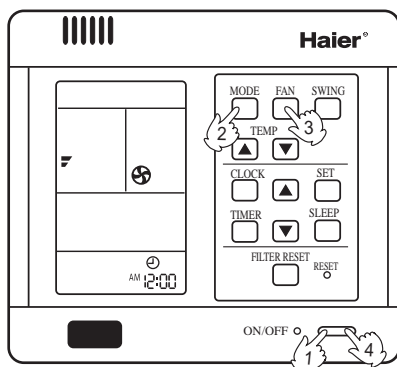

1 Turn on the unit
 Press the ON/OFF button to turn on the unit. The LCD display of the wire controller will show the previous working state (except for Timer, Sleep, Swing mode), the operation indicator light on the wire controller will light up.

2 Choose of working mode
 Press MODE button, each press the working mode will change as the following sequence:



choose FAN operation

3 Adjusting FAN SPEED

Press the FAN SPEED button to change fan speed:



Choose the desired fan speed

4 Turn off the unit
 Press the ON/OFF button to turn off the unit.
 The wire controller only shows the clock and room temperature.

About FAN operation:

FAN operation refers the air conditioner does not perform COOLING and HEATING operation, but FAN operation. In this mode, the air conditioner cannot perform AUOT FAN operation, and does show the temperature value on the wire controller.

Operation instruction Auto/Cooling/Dehumidifying/Heating operation

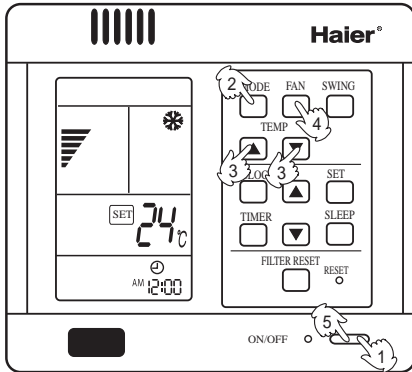

When room temperature is higher than set temperature, unit in COOLING operation.

Ultra-low air flow

Set temperature + 2*
Set temperature

When room temperature reaches set temperature + 2*, the unit will operate in mild dehumidifying operation.

In Heating operation, after start the unit, the air conditioner will sending warm air a moment later to prevent the cold air blowing out. In Dehumidifying, when the room temperature drops 2* higher than the set temperature, regardless the set fan speed, the air conditioner will intermittently operate in low fan speed.

About AUTO operation:

In AUTO operation, the air conditioner will operate and automatically choose COOLING, HEATING or FAN operation according to room temperature.

Hints:

The wire controller can memorize the working condition of each time. When start the unit for the second time, just need to press ON/OFF button, the air conditioner will work according to the previous working mode. (except for Timer, Sleep and Swing)

1 Turn on the unit

Press the ON/OFF button to turn on the unit The LCD display of the wire controller will show the previous working state (except for TIMER, SWING, SLEEP mode). The operation indicator light on the wire controller will light up.

2 Choose of working mode

Press MODE button, each press the working mode will change as the following sequence:



then choose AUTO, COOLING, DEHUMIDIFYING, HEATING operation.

3 Set temperature

Press the TEMP. SET button

*Each press , the set temperature will increase 1 degree.

*Each press, the set temperature will decrease 1 degree.

Set the desired temperature.

4 Adjusting FAN SPEED

Press the FAN SPEED button, for each press, the fan speed will change as the following sequence:



Choose the desired fan speed.

5 Turn off the unit

Press the ON/OFF button to turn off the unit.

The wire controller only shows the clock and room temperature.

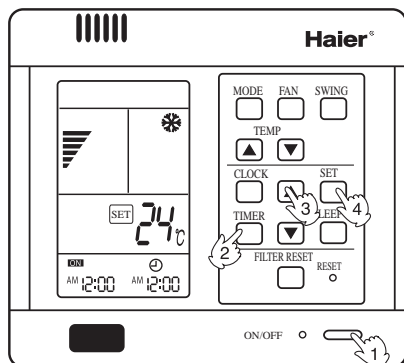

Before using TIMER function, calibrate the clock first (referring to page 3). When you wake up in the morning, before going back to home after work or after going to bed, you can let your air conditioner automatically turn on or turn off.

1. Turn on the unit

After turning on the unit, set the desired working mode.

The LCD of the wire controller will show working mode. (except for Timer, Sleep, Swing)

2. Set of TIMER mode

Press the TIMER button to change the TIMER mode, each press the TIMER mode will change as the following sequence:



Then choose the timer mode as you need (TIMER ON or TIMER OFF.)

At this time the* **ON** or **OFF** will flash.

3. Set time

Press the time adjusting button

* Each press, the set time increases 10 minutes. If depress the button, the time will increase rapidly.

*Each press, the set time decreases 10 minutes. If depress the button, the time will decrease rapidly.

This LCD will show the time set, the time can be adjusted within 24h. (AM stands for morning, PM stands for afternoon).

4. Confirm the time

After calibration of the clock, press SET button to confirm time.

At this time, the* **ON** or* **OFF** will not flash.

The time displayed is: at x o'clock x minutes the unit will be turned on (TIMER ON) or turned off (TIMER OFF).

■ Cancel TIMER

Press the **TIMER** button several times until the **TIMER** mode display disappears.

Hints:

After power failure, the clock should be calibrated again.

The wire controller has memory function, when you use this function for the second time, if the time set is the same as the previous one, you just need to choose the **TIMER** mode then press the **SET** button to confirm.

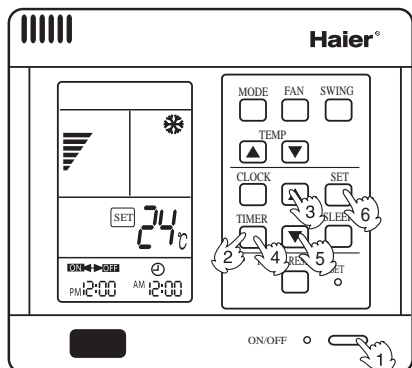

1. Turn on the unit

After turning on the unit, set the desired working mode.

The LCD of the wire controller will show working mode. (except for Timer, Sleep, Swing)

2. Set of TIMER mode

Press the TIMER button to change the TIMER mode, each press the TIMER mode will change as the following sequence:



Then choose the **TIMER ON-OFF** mode. At this time the " **ON** " will flash.

3. Set time

Press the time adjusting button

* Each press, the set time increases 10 minutes. If depress the button, the time will increase rapidly.

* Each press, the set time decreases 10 minutes. If depress the button, the time will decrease rapidly.

This LCD will show the time set, the time can be adjusted within 24h. (AM stands for morning, PM stands for afternoon).

4. Confirm the time

After adjusting time, press SET button to confirm time.

At this time, the " **ON** " will not flash, " **OFF** " begins to flash.

The time displayed is: at x o'clock x minutes the unit will be turned on.

5. Set the TIMER OFF time

Press the TIME button, the adjustment method is the same as the one of setting TIMER ON time.

6. Confirm the time of TIMER OFF

After adjusting time, press SET button to confirm time.

At this time, the " **OFF** " will not flash.

The time displayed is: at x o'clock x minutes the unit will be turned off.

■ Cancel TIMER

- Press the TIMER button several times until the TIMER mode display disappears.
- According to the sequence of TIMER ON & TIMER OFF setting, you can realize turning on unit first, then turning off unit.

Operation instruction

Sleep operation

Before going to bed, you can press the SLEEP button, the air conditioner will operate in comfort sleep mode to make you have a sound sleep.

Before using this function, you should calibrate the clock first, otherwise, the SLEEP function will be out of order.

Use of SLEEP function

After turning on the unit, setting the working mode, then press SLEEP button to make the air conditioner have the previous Sleep time (powered on for the first time or after performing Sleep is 1h). The Sleep symbol will appear. Press time */* button, you can choose between 1~8h. Each press, it may increase/decrease 1h and will display in the humidity area with $\bar{x}h\bar{f}$, and display \bar{i} Timer Off \bar{f} in Timer Off area and the time to turn off; press Sleep button again to cancel Sleep function. The Sleep symbol disappears.

Operation modes

1.In COOLING, DEHUMIDIFYING operation

1 hour later in SLEEP operation, the temperature will increase 1* from the set temperature, another 1 hour later increase another 1*, then the unit will operate continuous for 6 hours, then it turns off automatically. The temperature is higher than set temperature to prevent you from getting a cold.

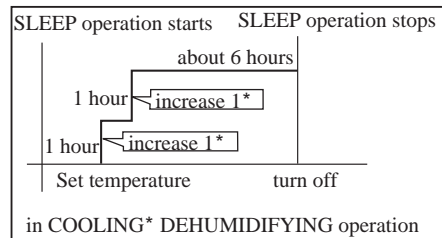

2.In HEATING operation

1 hour later in SLEEP operation, the temperature will decrease 2* from the set temperature, another 1 hour later increase another 2*, then the unit will operate continuous at this temperature for 3 hours, then it increases 1*, after operating at this temperature for another 3 hours, the unit will turn off automatically. The temperature is lower than set temperature to prevent you from feeling uncomfortable during sleep.

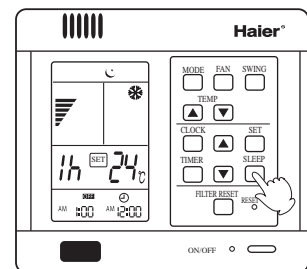
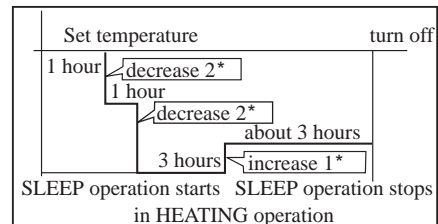

Note:

- 1 After setting Sleep function, it is not permitted to adjust clock.
- 1 The Sleep time is less than 8h, after reaching the set time, the unit will automatically stop.
- 1 Set Sleep function after setting \bar{i} Timer Off \bar{f} function, the air conditioner will perform Sleep function.
- 1 After setting Sleep function, the Timer function cannot be set.
- 1 Set Sleep function after setting \bar{i} Timer On \bar{f} function, the Sleep function can only be set in the set time of Timer On.

Users' Attention

- Do not press tightly with the LCD part of the wire controller to avoid damage of it.
- **Set proper room temperature**
Not too low or high and make every people in the room feel comfortable.



- **Do not let the cold air blows directly to human body for a long time and do not make the room temperature drop too low.**

Otherwise, it may cause uncomfortable or bad to your health.



- **The airflow cannot directly blow to the pets and plants.**

Otherwise, pets and plants may be hurt.



- **The room should often ventilate.**

After a long-time of using air conditioner, the room must be ventilated.



- **Do not keep the doors and windows open**

Otherwise, it may lower the efficiency of the air conditioner.



- **Television, radio and acoustics, etc. equipment should keep over 1m from indoor unit and wire controller.**

Otherwise, they may disturb the image and cause noise.



- **Do not put any drying devices under the indoor unit.**

The heat may cause the deformation of indoor unit.



- **If do not use the air conditioner for a long time, it is necessary to cut off power.**

If do not cut off power, the unit may consume power. In order to protect the unit, before using the air conditioner again, turning on the power at least 12 hours in advance.

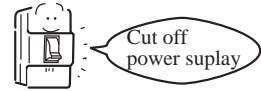

- **The windows should be hung with curtains or blinds.**

Do not let the sun shine directly shine in the room; do not let the outdoor air enter room.



- **The articles must keep dry cannot be put under the indoor unit.**

When the humidity is over 80% or the drainage outlet is blocked, the indoor unit may drop water.



- **Do not put articles around the air inlet and outlet.**

This kind of obstacle can lower the efficiency of the air conditioner or cause unit trouble.



- **The air conditioner can only be used in air conditioning. It can not be used in other purpose.**

Do not use the air conditioner in some specific purpose, such as storage or protect food, animals, plants, precise instrument and artwork, otherwise, the quality of them may be declined.



Maintenance

⚠ Notice

- The repair can only be performed by the professional workers.
- Before touch the wire connection device, cut off the power first.

⚠ Notice

- Only after turning off the unit and cutting off the power can the cleaning of the unit be performed. Otherwise, it may cause electric shock or injury.
- Do not use water to clean the air conditioner. Otherwise, it may cause electric shock



- Use stable stand support. Please pay high attention when cleaning the unit

Clean the air filter

Clean

⚠ Notice

- Do not use the hot water over 50* to clean to avoid discoloration or deformation.
- Do not dry the unit on fire, the filter may be burnt.

Use cleaner or water to clean to remove dust.

A Use cleaner to remove dust.



* B * When the dust is too much, use soft brush and neutral detergent.



(C) Throw the water off, then put it in the shadow for airing.

Maintenance before and after the using season.

Before using season

1. Check the following items:

- If the air inlet and outlet of indoor and outdoor unit are blocked.
- If the earth wire is proper.
- If the wire connection is proper.
- If there is abnormal phenomenon, please ask the after-sale service staffs for help.

2. Cleaning the air filter or air inlet and casing

- After cleaning the air filter, it must be reinstalled.

3. Turn on the power

- After turning on the power, words appear on the LCD screen of the wire controller.

After using season

1. In a sunny day, perform half-a-day Fan operation to make the inner of the unit dry.

2. Cut off the power



- If do not cut off power, the unit will consume power. Power cutoff can save power.

3. Cleaning the air filter or air inlet and casing

- After cleaning the air filter, it must be reinstalled.
For the details of cleaning, please refer to Maintenance.

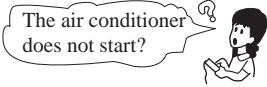
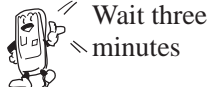

Troubleshooting

The following phenomena are not troubles

| Symptom | Cause |
|---|--|
| Hear the sound of water flow  | When the air conditioner is started; during operation the compressor starts or stops; or when the unit is stopped; sometimes it gives the sound of 'Hua, Hua' or 'Gudu, Gudu'. This is the sound of the refrigerant circulation, not trouble. |
| Gives 'Pi, Pa' sound | It is caused by the hot expansion and cold shrink of the plastic part. |
| Having peculiar smell | Sometimes the air sent from the indoor has peculiar smell, the smell is what the cigarette smoke naturally has or caused by the inner paint of the unit. |
| During operation, the indoor unit produces mist.  | During COOLING or DEHUMIDIFYING, you may see the unit produces whiffs of light mist. It is caused by the sudden cold indoor air blown out from the unit producing condensation mist. |
| During COOLING operation, the mode changes from AUTO to FAN. | To prevent the frost from forming on the indoor unit heat exchanger, sometimes the unit will automatically change to FAN mode, but sooner it will resume to COOLING mode. |
| After stopping the unit, it can not start immediately.  | Even the operation button is set on ON, within 3 minutes after the unit stops, Cooling, Dehumidifying or Heating mode can not start. It is because the self-protection of the system. (In this 3 minutes, the air conditioner is in Fan mode)  |
| During DEHUMIDIFYING, there is no air blown out or the FAN SPEED can not be changed. | In DEHUMIDIFYING operation, when the room temperature is too low, the fan motor will automatically and repeatedly drop the fan speed |
| During operation, the operation mode changes to Auto. | Whether choosing Auto mode? In Auto mode, according to room temperature, the operation mode will automatically change Cooling to Heating, vice versa. |

When Troubles Occur

Before asking the commissioned repair center for help, please check the air conditioner according to the following items.

| The air conditioner can not start | | | |
|--|---|---|--|
| <p>Is the power switch connected?</p>  <p>The power switch is not at ON position.</p> | <p>If the city electric power supply is normal?</p>  | <p>If the wire controller is directly shined by sunshine or affected with damp.</p> | <p>If the earth creepage breaker works?</p> <p>Please cut off power immediately and contact with supplier.</p> |
| Bad cooling effect | | | |
| <p>Did you adjust the controller as what is specified?</p> | <p>If the air filter is too dirty?</p> | <p>Are doors or windows closed?</p> | <p>If the air inlet or outlet is blocked by obstacles?</p> |
| Bad heating effect | | | |
| <p>If the air out louver is in horizontal? (Heating mode)</p> <p>If the air out louver is horizontal, the warm air can not blow on the floor.</p> | <p>The air conditioner does not blow air in Heating operation, if it is in anti-cold air state? Referring to page7.</p> | | |

If after the above checking and treatment, the air conditioner still can not work normally, or find the following phenomena, please stop the operation of the unit and contact the commissioned repair center.

- The fuse or breaker often opens circuit.
- During Cooling or Dehumidifying, there is water leakage.
- Abnormal operation or abnormal sound is heard.
- The operation indicator light on the wire controller flashes and trouble code (E₀, E₁, ..., E₉) appears on the screen to indicate the trouble of the air conditioner.

When Troubles Occur

When the following phenomena appear, please contact the commissioned repair center.



- If finding any abnormal phenomena (such as adust smell), cut off power first, then ask the after-sales service workers for help.
- If still using the air conditioner in this condition, the air conditioner may be damaged and causes electric shock or fire accident.

| Symptom | After taking the following measure, then contact the commissioned repair center |
|---|---|
| The safety equipment, such as fuse, breaker and creepage breaker, has been open circuit for many times; or the operation switch cannot work normally. | Cut off power. |
| The air conditioner leaks water. | Cut off power and inform the commissioned repair center. |

Trouble code display

| Phenomenon of outdoor unit trouble | The flashing time of indicator light on outdoor control panel | Indoor control panel indication |
|--|---|---|
| The trouble of outdoor ambient temperature sensor | 1 (A, B systems indicate together) | E3 |
| The trouble of outdoor coil temperature sensor | 2 (A and B system indicate individually) | E4 |
| The trouble of outdoor discharging air temperature sensor | 3 (A and B system indicate individually) | E4 |
| The outdoor discharging air temperature is too high | 4 (A and B system indicate individually) | E4 |
| Over electric current protection | 5 (A and B system indicate individually) | E5 |
| CT wire breaks | 6 (A and B system indicate individually) | E5 |
| The communication trouble between indoor and outdoor unit | 8 (A and B system indicate individually) | E8 |
| Pressure protection | 9 (A and B system indicate individually) | E6 |
| Phenomenon of indoor unit trouble | Trouble indication on remote control type indoor unit | Trouble code on wire control type indoor unit |
| The trouble of indoor ambient temperature sensor | The compressor indicator light flashes 1 time in 0.2S/time frequency | E1 |
| The trouble of indoor coil temperature sensor | The compressor indicator light flashes 2 time in 0.2S/time frequency | E2 |
| The trouble of outdoor ambient temperature sensor | The compressor indicator light flashes 3 time in 0.2S/time frequency | E3 |
| The trouble of outdoor coil temperature sensor | The compressor indicator light flashes 4 time in 0.2S/time frequency | E4 |
| The trouble of electric current overload | The compressor indicator light flashes 5 time in 0.2S/time frequency | E5 |
| The trouble of overloadPressure protection | The compressor indicator light flashes 6 time in 0.2S/time frequency | E6 |
| | The compressor indicator light flashes 7 time in 0.2S/time frequency | E7 |
| The communication trouble between panel and indoor panel | The compressor indicator light flashes 8 time in 0.2S/time frequency | E8 |
| The communication trouble between indoor panel and outdoor panel | The compressor indicator light flashes 9 time in 0.2S/time frequency | E9 |
| The trouble of water pump | The compressor indicator light flashes 10 time in 0.2S/time frequency | E0 |

Installation instruction

- Before installing, do read this "Safety precautions" carefully to guarantee the proper installation.
- The below attentive matters are divided into "Warning" and "Note" two parts. When the wrong installation occur, it is very possible death and severe injury and other serious accidents will happen. For those items are listed in "Warning" part. But even the items listed in "Note" part can also cause serious accidents. Above all, both the two parts are very important contents related to safety, so they must be obeyed.
- After finishing the installation work, do test run to verify everything is normal. After that please explain the using and maintenance methods to the user. Additionally, give this installation manual and operation manual to the user and ask them to keep it properly.

Warning

- The commissioned repair center shall do the installation work. If you do the installation work by yourself, the improper installation will cause water leakage, electric shock fire and other accidents.
- The installation work shall be in line with what the installation manual specified. If installation is not proper, water leakage, electric shock, fire and other accidents will occur.
- Install the air conditioner to a place where can definitely stand its weight. The air conditioner can not be installed on a nonmetal bracket (such as theft guard net). Places not firm enough will cause drop down of unit resulting in body hurt.
- The installation work shall be preventive to typhoon and earthquake. If the installation work is not met with the requirements, overturn of the unit will occur resulting in accidents.
- Using the specified cable to do wiring work and connecting firmly and properly. Fix the connecting part of the terminals to prevent it from the external force. Improper connection and fixing will cause heating and fire etc. accidents.
- Wiring shall be kept in correct shape avoiding extrusion. After installation, the electric box cover and the external panel shall not nip the wire. Improper installation will cause heating and fire etc. accidents.
- When setting or moving the air conditioner do not let the air and things alike get into the refrigeration system except the specified refrigerant (R22). If air and other things enter, abnormal high pressure will occur, which easily cause break and body injuries etc. accidents.
- When installing, do use the accessories or specified parts. If not using the parts specified by our company, water leakage, electric shock, fire and refrigerant leakage will occur.
- Do not lead the drain hose to drain where the sulfur gas may be involved. Otherwise, the poisonous gas will enter into the indoor.
- During installation, if refrigerant leakage occurs, do the ventilation work immediately. As soon as the refrigerant gas meets fire, poisonous gas will be produce.
- After installation, confirm there is no leakage of refrigerant. If the refrigerant gas enters into room and meet the air blowing heater, heater or stove etc. fire source, the poisonous gas may be produced.
- Do not install the unit in a place where the combustible gas may be leaked. In any case the combustible gas leaks and accumulated around the unit, fire accident will occur.
- The drain hose should be correctly installed according to the installation manual to ensure smooth drainage, and take proper heat preservation measure to prevent from dew. Improper pipe installation may cause water leakage result in wet the indoor articles.
- Do heat insulation work to the refrigerant gas pipes and liquid pipes to reach the purpose of heat preservation. If the heat insulation measure is not sufficient, water generated by condensing dew will drip leading to wet the floor and indoor articles.

Note

- Do grounding work. Do not connect the grounding wire to gas pipe, tap, lighting rod or telephone line. Improper grounding will cause electric shock.
- In some places the creepage breaker shall be installed. If do not install the breaker, electric shock may occur.
- After electric installation, power on them to do electric leakage test.

Installation instruction

⚠ Notice

This manual can not include all kinds of conditions, if you have new requirements and questions, please contact with local Haier Sales Center.

⚠ Warning







Before installing the unit, please read this manual carefully. Improper installation may cause accidents and make unit damage or death.





Installation tools

- | | | |
|-------------------------------|---------------------------------|----------------------------|
| 1. Screwdriver | 2. Steel saw | 3. 60, 70mm diameter drill |
| 4. Spanner (diameter 17,27mm) | 5. Spanner (14, 17, 19, 27mm) | |
| 6. Pipe cutter | 7. Pipe flarer | 8. Knife |
| 9. Pincers | 10. Leakage detector/soap water | |
| 11. Tape measure | 12. Scraper | 13. Refrigerant oil |

Accessories attached with the unit

The following is the manual mentioned standard accessories, please check them by yourself. As the following figure shown

| No. | ① | ② | ③ | ④ | ⑤ | ⑥ |
|--------------|--|--|--|--|---|--|
| Shape & name | Wire controller (signal wire)  | Signal wire  | Refrigerant oil  | Little wire clamp  | Big wire clamp  | Thermal insulation pipe  |
| Amount | 1 | 1 | 1 | 6 | 2 | 2 |

| No. | ⑦ | ⑧ | ⑨ | ⑩ | ⑪ |
|--------------|--|---|---|--|---|
| Shape & name | Plastic clamp  | Seal cushion  | Gasket  | Cement steel nail  | Screw  |
| Amount | 6 | 4 | 8 | 12 | 3 |

1. Before installation [Before finishing installation, do not throw the attached parts installation needs]

- Confirm the way to move the unit to the installation place.
- Before moving the unit to the installation place, do not remove their packages. When have to remove the package, use a soft material or protection board with rope to lift the unit assembly to avoid unit damage or bumping a scrape.

2. Choose installation place

(1)The chosen installation place should meet the following requirements and get the user's consent.

Place ensures ideal airflow distribution.

The passage of airflow has no obstacles.

The condensate water can be drained smoothly.

Place can stand the weight of indoor unit.

Place ensures enough space for maintenance.

The pipe length between indoor and outdoor unit is in the permitted limit (referring to outdoor unit installation part).

The indoor unit, outdoor unit, electric wire and connection wire is at least 1m away from television and radio. This is to avoid the image disturbance and noise caused by the above-mentioned home appliance. (Even if 1m away, if the electromagnetic wave is too strong, it can also cause noise.)

(2)The height of ceiling

The indoor unit can install on the ceiling, which height is no more than 2.7m.

(3)Install and use the hoisting screw. Check if the installation place can bear the weight of unit assembly. If not certain, strengthen it before install the unit.

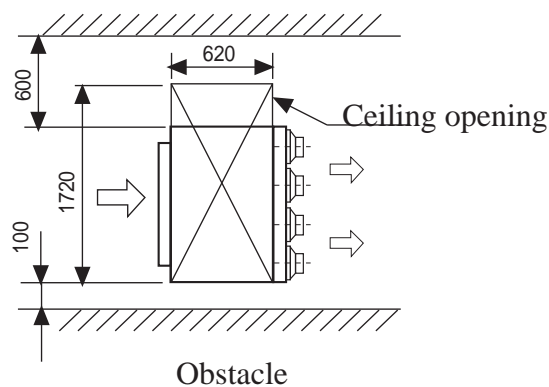

Space installation needed (unit: mm)

3. Preparation before installation

(1) The position relation among ceiling opening and hoisting screws (unit: mm)

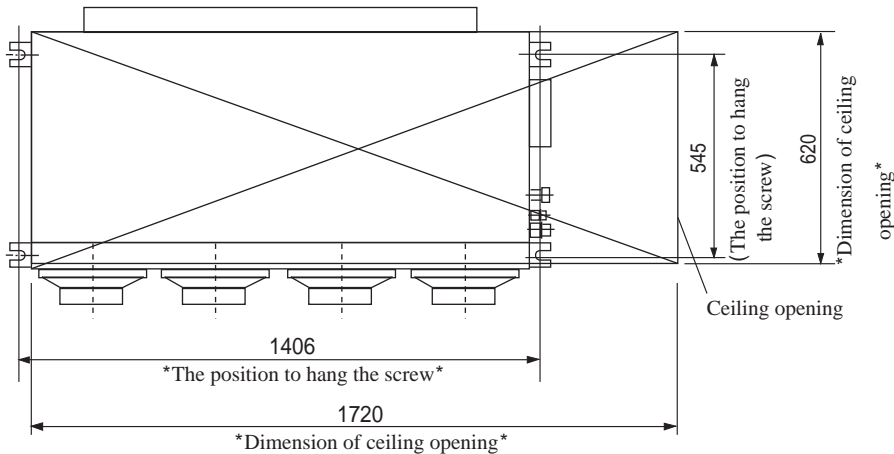

(2) If necessary, cut a opening on the ceiling for installation and checking. (in original ceiling circumstance)

- For the dimension of the ceiling opening, please refer to the above Figure.
- Before installation, finish the preparation work of all the pipes (refrigerant pipe, drain hose) and wires (connection wire of wire controller and of indoor and outdoor unit) first to make it easy to connect them to indoor unit as soon as installation begins.
- Cut a opening in the ceiling, it is necessary to strengthen the ceiling to keep the ceiling level and prevent the vibration of the ceiling. For details, please consult to the builder.

(3) Install the hoisting screw

(Use M10 screw bolt)

In order to bear the weight of the unit, for existed ceiling, using foundation screw bolt, for new ceiling, using burying embedded screw bolt, burying screw bolt or spot supplied other parts.

Before going on installation, adjust the gaps with ceiling.

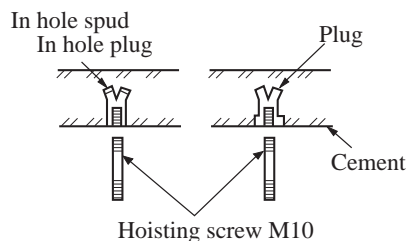

4. Installation of indoor unit

- Fix the indoor unit on the hoisting screw.
If necessary, suspend the unit on the crossbeam. Do not use hoisting screw, directly use screw bolt.

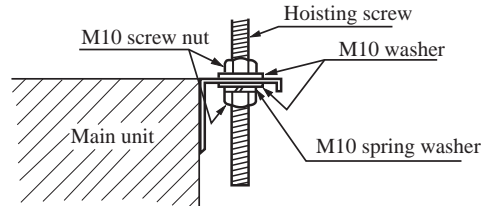

Note:

If the dimension of main parts does not meet the opening of the ceiling, adjust the slot of suspending bracket.

Adjust to level

- Use gradienter or other methods to perform level adjustment.
 - Perform level adjustment to make the relationship between the bottom surface of the equipment and the horizontal surface as shown below.

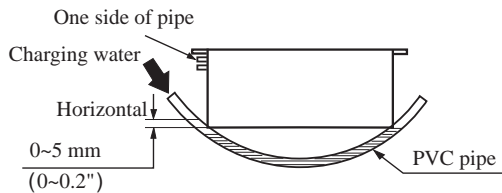

- Unless adjust to horizontal, otherwise the floating switch may have trouble or misplay.

Choose the air sending of the fan motor

(When use high performance air filter)

The fan motor is equipped with red and white terminals, when in factory, the air sending has already been set at the standard choose.

When using the high performance air filter, etc. optional parts leading to the static pressure rise, please according to the following figure shown to change the connection of the connector installed on the side of control box.

| Standard air sending (when deliver the air conditioner) | | | | High fan speed air sending | | | | |
|---|--------|------------------|-------|----------------------------|-----------------------------|-------|-----|-----------------------|
| One side of the control box | White | Connector: White | White | One side of Fan motor | One side of the control box | White | Red | One side of Fan motor |
| | Blue | | | | | Black | | |
| | Yellow | | | | | White | | |
| | Red | | | | | Blue | | |
| | | | | | | Red | | |
| | | | | | | | | |
| | | | | | | | | |
| | | | | | | | | |

5. Drain hose

(a) The drain hose should always have a slant degree (1/50~1/100) to avoid the protruding part or causing water flow bend.*

- **Good pipe system**

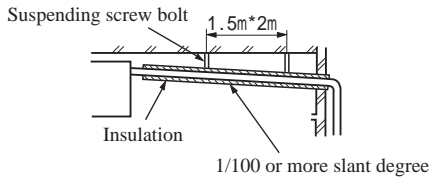

- **Improper pipe system**

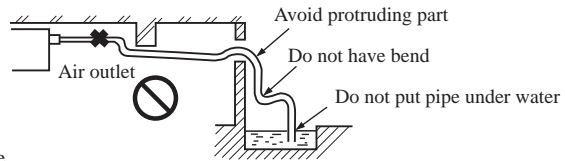

- (b) When connecting the drain hose with equipment, be sure not to use too much force to the pipe on one side of the equipment. At the same time, the fixation of pipe should be close to equipment as possible as it can.
- (c) For the drain hose, it can be the local bought stiff PVC pipe for normal purpose. When connecting, insert the end of PVC pipe into the drain hole, then use drain hose and wire fastener to fix them tight. The bond can not be used to connect drain hole and drain hose.

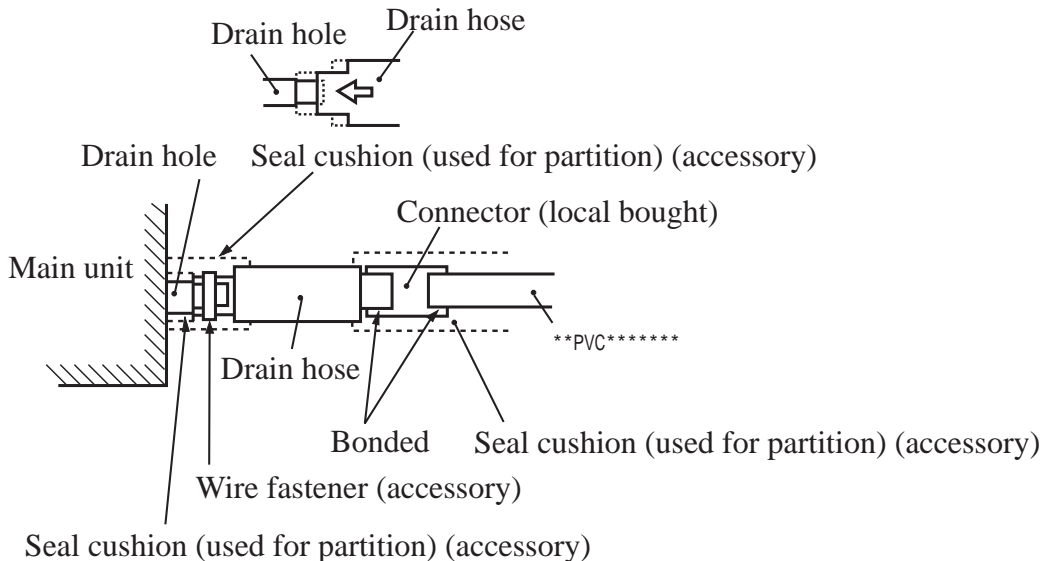

- (d) When the equipped drain hose used to many units, the position of public pipe should be 100mm lower than the drain hole of any unit. As the figure shown. For this purpose, the thicker pipe should be used.

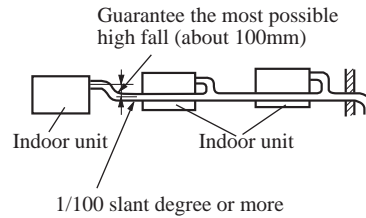

- (e) The stiff PVC pipe put indoor side should be heat insulated.
- (f) The lifting height of the drain hose should be at the position over ceiling within 500mm. When there is obstacle on the ceiling, use bracket and things alike to lift the drain hose to avoid the obstacle. During this work, if the extending height is higher than 500mm, the return flow of drainage may become too much leading to the drainage groove overflow. So, the height of the drain hose should be kept within the tolerance range given in the follow figure.

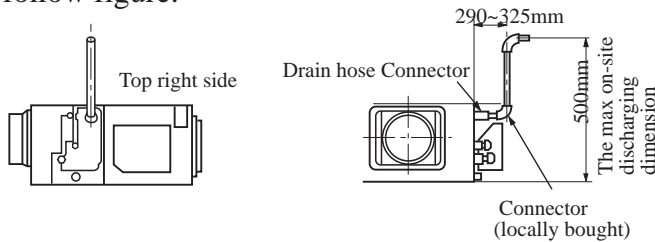

- (g) Avoid putting the outlet of drain hose in the places with irritant gas generated. Do not insert the drain hose directly into drainage, where the gas with sulfur may be generated.

Test of drainage system

- After finishing electric engineering, perform drainage system test.
- During test, confirm if the water properly passes through the pipe and there is no water leakage in the joint.
- In a new house, perform test before installing the ceiling.
- Even if installing the air conditioner in a heating operation needed season, the test also must be performed.*

Procedure

- Dismantle the side panel, slowly charge 1000cc water into the drain pan to confirm the smooth drainage and without water leakage.
- In Cooling operation, check the drainage system.

Insert into the water supplying pipe 20mm~30mm
(insert the drain hose toward bottom)

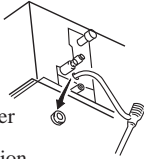

Remove the rubber stopper, after finishing installation, it must be reinstalled

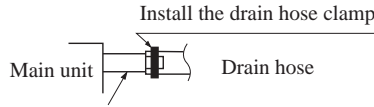

Check the condition of drainage through the transparent hose base

Pour water into the protruding connector

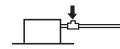

Before finishing the wiring work, install a protruding connector on the drain hose to provide a water in hole. Then, if there is water leaks from the pipe system, perform check. Finally, the water flow through the drain hose should normally pass.

6. Installation of air suction and discharging duct

Please consult the after-sales service worker of Haier Air Conditioner for the choosing and installation of suction inlet, suction duct, discharging outlet and discharging duct. Calculating the design drawing and outer static pressure, and choose the discharging duct with proper length and shape.

- The length difference among every duct is limited below 2:1.
- Reduce the length of duct as possible as can.
- Reduce the amount of bend as possible as can.
- Use heat insulation material to bind and seal the part connecting main unit and the flare part of air discharging duct. Perform duct installation work, before the fitment of ceiling.

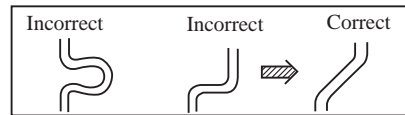
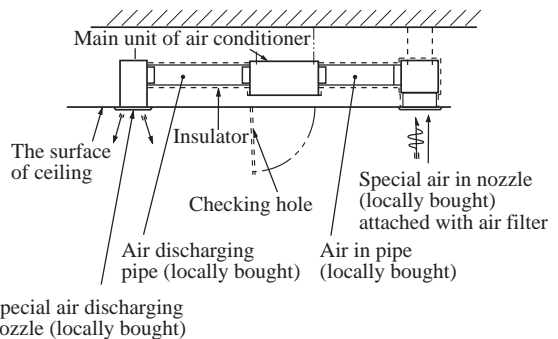

7. Connection of air suction and discharging duct

(a) Absorb of fresh air (single air supplying)

Use side air absorbing nozzle or absorb from the air in pipe

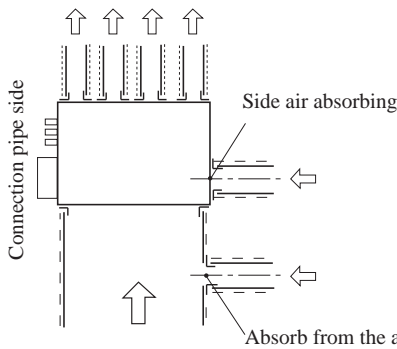

(b) Air discharging

Use side air discharging nozzle (do use together with air absorbing)

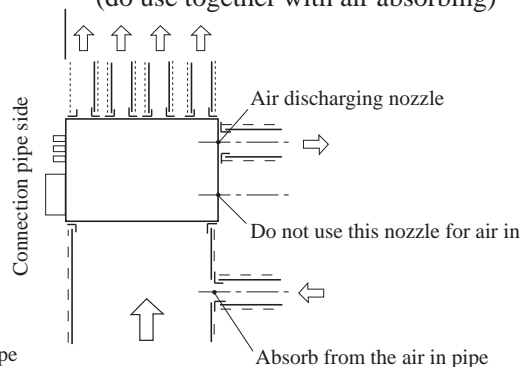

(c) Perform thermal insulation to the duct to prevent from frosting

8. The attentive matters in installation of air suction and discharging duct

- Recommend to use anti-frost and sound-absorbing duct. (locally bought)
- The duct installation work should be finished before the fitment of ceiling.
- The duct must be heat insulated.
- The specific air-discharging outlet should be installed at the place where the airflow can be reasonably distributed.
- The surface should leave a checking hole for checking and maintenance.

9. The examples of improper installation

- Do not use air in duct and take the ceiling inner side instead. The result is because of the irregular outer air mass, strong wind and sunshine, the humidity is increased.
- There may be water drop on the outside of duct. For cement and other new constructions, even if not taking ceiling inner side as duct, the humidity will also be so high. At this time, use glass fiber to perform heat preservation to the whole. (use iron net to bind the glass fiber)
- Maybe exceeding the unit operation limit (for example: when indoor dry bulb temperature is 35*, wet bulb temperature 24*), it may lead to overload of compressor.
- Affected by the capacity of air discharging fan, the strong wind in the outer duct and wind direction, when unit air sending volume exceeds the limit, the discharged water of heat exchanger will overflow, leading to water leakage.

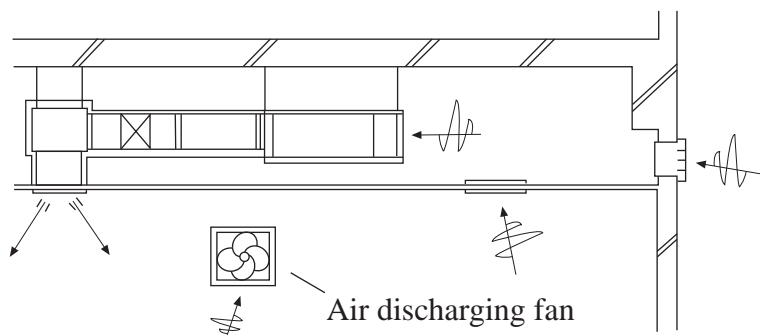
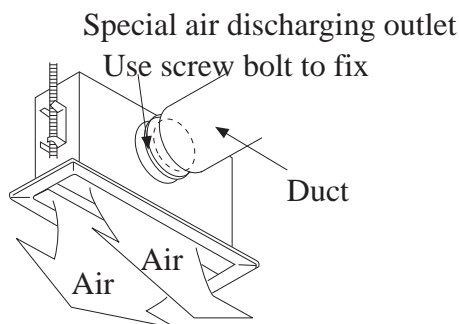

Improper example

1. Remove the upper cover of wire controller

The PC board is installed on the back cover of wire controller. When remove the upper cover, pay attention not to damage PC board.

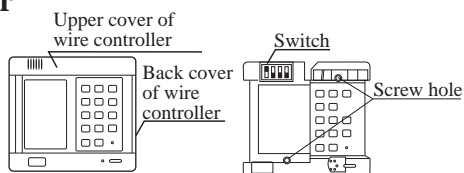

2. Install wire controller

Drill 2 wall holes according to the position of the 2 screw holes on the back cover of wire controller, then hit wood in the wall holes. Put the 2 screw holes on the back cover of wire controller properly to its corresponding wood, then use wood screws to fix the back cover on the wall.

Note:

Install the back cover of wire controller on the even wall as possible as can.

When tightening the wood screw, do not use too tight force, otherwise the wire controller may be damaged.

Switch

| Mark | ON | OFF |
|------|--|-------------------------------------|
| 1 | 3 grades fan speed | 2 grades fan speed |
| 2 | Have rise and drop | No rise and drop |
| 3 | Swing | Not Swing |
| 4 | The collection temperature of main panel | The collection temperature of panel |

Under this series, the switch is set as: 1.ON 2. OFF 3. OFF 4.OFF

3. Indoor unit wire connection

Connect the terminals (A, B, C, D,) on the wire controller to the terminals on the indoor PC panel (A, B, C, D,) respectively.

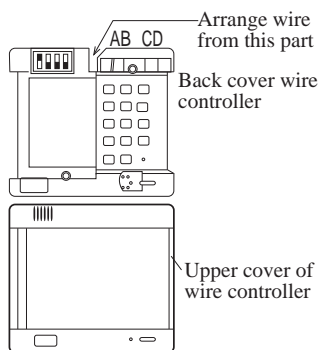

Note: When connecting wire, please keep a certain distance between signal wire and electric wire. (over 10mm)

Dimension of signal wire:

| Type of wire | Shield wire (4 cords) |
|--------------|-----------------------|
| Dimension | 0.33mm ² |

*The connection between indoor unit and wire controller and indoor unit and outdoor unit should use shield wire. And the two ends of the shield wire should be grounded, otherwise, the disturbance will cause unit abnormal operation.

Note:

Confirm the connection part of terminals is firm and will not touch shield wire.

4. Cover the wire controller upper cover

Pay attention not to press the connection wire.

Note: (1) The power switch and the signal wire are self-provided.
(2) Do not touch PC board by hand.

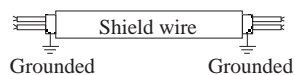

1. Connection of pipe

Connection method

- For the specific max length and the max fall of connection pipe, please refer to the manual of outdoor unit.
- In order to guarantee the efficiency, the pipe should be as short as possible.
- Daub the refrigerant oil on the joint and the flared nut.
- When bending the pipes, give the roundness as large as possible, to avoid crashing the pipes.
- To connect the pipe, fit the center and use hand to screw the nut, then use s-panner to tighten the nut, as shown in figure.
- Pay attention not to let alien matters, such as sand, vapor get into the pipe.
- The connection of indoor unit pipe must be performed by using two spanners.

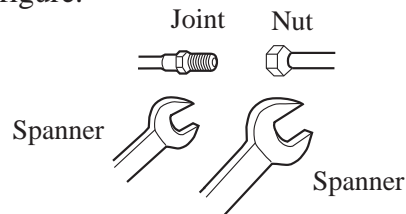

2. Dimension of connection pipe

| Pipe diameter | Fasten torque |
|----------------------------------|----------------|
| Liquid pipe \varnothing 9.52mm | 32.7~39.9 N.m |
| Gas pipe \varnothing 19.05mm | 97.2~118.6 N.m |

If do not fit the center and screw the nut hard, the screw thread may be damaged, which will cause refrigerant leakage.

3. The additional charging amount of refrigerant

- The additional charging of refrigerant (R407C) should be complied with the installation manual of outdoor unit. It must use measurer to quantificationally charge. The additional charging amount must be complied with the specified amount.

Requirements: Both excessive charging and less charging of refrigerant will cause the compressor trouble. It must be complied with the specified amount.

4. Vacuumizing

- Use vacuum pump to perform vacuumizing through the stop valve of outdoor unit.
- It is strictly prohibited to use the refrigerant sealed in the outdoor unit to perform air discharging.

5. Leakage detection

- Use leakage detector or soap water to check if the connected part of the connection pipe and the valve cap leak.

6. Thermal insulation treatment

- The thermal insulation of connection pipe should be performed at both gas side and liquid side. In COOLING, both liquid side and gas side are in low temperature, in order to prevent dew from forming, thermal insulation should be done.
- The thermal insulation material at the gas side must use the material with the heat resistant temperature over 120*.
- The connected part of indoor unit connection pipe should be thermal insulated.

Note:

- All the wires should be copper core wires.
- The power cable of indoor unit should be equipped according to the operation manual of indoor unit.
- Before finishing vacuumizing the refrigerant pipe system, do not supply power to indoor unit.
- The connection of power cable should be complied with local wiring regulation.

Wiring method

1. The wiring method of orbicular terminal

For the connection wire which end is orbicular terminal, its wiring method is as the right figure shown. Dismantle the screw and put it through the ring at the end of the connection wire, then connect it to the terminal block and tighten the screw.

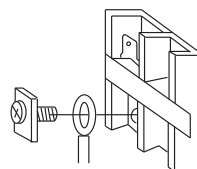

The wiring method of orbicular terminal

2. The wiring method of straight terminal

For those connection wires whose end are not orbicular terminals, their wiring method is:

Loosen the connecting screw, insert the end of the wire directly into the terminal block, and then tighten screw. Pull the wire outwards slightly to confirm it is held tightly.

3. Pressing method of connection wire:

After wiring, the connection wire must be pressed with wire holding clamp. The wire holding clamp should press on the out cover of the connection wire. As the right figure shown:

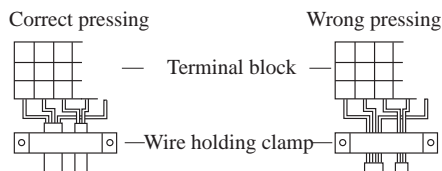

(Sketch map)

Connect wire between indoor & outdoor unit

According to the wiring diagram in the manual of the outdoor unit to perform wiring work.

Note: The marks on the terminals of the end of the connection wire should be corresponding one by one.

Note:

- When connecting the indoor & outdoor wire, check the number of the indoor & outdoor terminals, the terminals with the same number connected together with one wire.
- Incorrect wiring will damage the controller of the air conditioner or make the unit work abnormally.
- The connection type of power cord is Y connection. If the soft power cord is damaged, to avoid risk, it must be replaced by the manufacturer or their specific repair department or similar professional worker.

Other instruction

1. Power supply

The air conditioner must use a special power circuit and special air switch. The users should provide special switch, grounding wire by themselves. The wiring should be done by a qualified electrician according to the wiring rules specified by national standard. An creepage breaker should be installed. The grounding wire and null wire of receptacle should be strictly separated. It is incorrect to connect the null wire with grounding wire. The connection method of power cord is Y connection. If the power cable is damaged, in order to avoid danger, it must be replaced by the manufacturer or its specified repair center of the same qualified worker.

2. Cut and flaring method

Use pipe cutter to cut the pipe, the burrs must be removed. After inserting the flarer, perform flared nut.

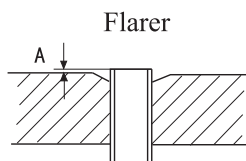

Flaring dimensions as follows:

| Connect pipe | Pipe diameter | Dimension A (mm) |
|--------------|----------------|------------------|
| Liquid pipe | 9.52mm (3/8") | 1.0-1.2 |
| Gas pipe | 19.05mm (3/4") | 1.4-2.2 |

| Correct | Incorr | | | | |
|---------|--------|--------|-------|-------------|----------|
| | Slant | Broken | Burrs | Uncompleted | Too long |

Test run

After installing the refrigerant pipe, drain hose and electric wire properly, perform test run to ensure the system not have trouble.

It is necessary the installer perform the test run for one time to check if the unit works normally.

Note: The wiring diagram of this model is pasted inside of the unit.

Free Manuals Download Website

<http://myh66.com>

<http://usermanuals.us>

<http://www.somanuals.com>

<http://www.4manuals.cc>

<http://www.manual-lib.com>

<http://www.404manual.com>

<http://www.luxmanual.com>

<http://aubethermostatmanual.com>

Golf course search by state

<http://golfingnear.com>

Email search by domain

<http://emailbydomain.com>

Auto manuals search

<http://auto.somanuals.com>

TV manuals search

<http://tv.somanuals.com>