

DUCT TYPE AIR CONDITIONER

Operation manual Installation manual

AD842AHEAA
AU84NATEAA

No. 0150504624 B

- Please read this operation manual before using the air conditioner.
- Please keep this manual carefully and safely.

Contents

Cautions	2-2
Safety Precautions	3-5
Parts and Functions	6-6
Heating Mode	7-7
Care and Maintenance	8-8
Troubleshooting	9-11
Precaution for Installation	12-12
Is the Unit Installed Correctly	13-13
Installation Procedure	14-25

Cautions

Disposal of the old air conditioner

Before disposing an old air conditioner that goes out of use, please make sure it's inoperative and safe. Unplug the air conditioner in order to avoid the risk of child entrapment.

It must be noticed that air conditioner system contains refrigerants, which require specialized waste disposal. The valuable materials contained in a air conditioner can be recycled. Contact your local waste disposal center for proper disposal of an old air conditioner and contact your local authority or your dealer if you have any question. Please ensure that the pipework of your air conditioner does not get damaged prior to being picked up by the relevant waste disposal center, and contribute to environmental awareness by insisting on an appropriate, anti-pollution method of disposal.

Disposal of the packaging of your new air conditioner

All the packaging materials employed in the package of your new air conditioner may be disposed without any danger to the environment.

The cardboard box may be broken or cut into smaller pieces and given to a waste paper disposal service. The wrapping bag made of polyethylene and the polyethylene foam pads contain no fluorochloric hydrocarbon.

All these valuable materials may be taken to a waste collecting center and used again after adequate recycling.

Consult your local authorities for the name and address of the waste materials collecting centers and waste paper disposal services nearest to your house.

Safety Instructions and Warnings

Before starting the air conditioner, read the information given in the User's Guide carefully. The User's Guide contains very important observations relating to the assembly, operation and maintenance of the air conditioner.

The manufacturer does not accept responsibility for any damages that may arise due to non-observation of the following instruction.

- Damaged air conditioners are not to be put into operation. In case of doubt, consult your supplier.
- Use of the air conditioner is to be carried out in strict compliance with the relative instructions set forth in the User's Guide.
- For the purpose of safety, the air conditioner must be properly grounded in accordance with specifications.
- Always remember to unplug the air conditioner before opening inlet grill. Never unplug your air conditioner by pulling on the power cord. Always grip plug firmly and pull straight out from the outlet.
- All electrical repairs must be carried out by qualified electricians. Inadequate repairs may result in a major source of danger for the user of the air conditioner.
- Do not damage any parts of the air conditioner that carry refrigerant by piercing or perforating the air conditioner's tubes with sharp or pointed items, crushing or twisting any tubes, or scraping the coatings off the surfaces. If the refrigerant spurts out and gets into eyes, it may result in serious eye injuries.
- Do not obstruct or cover the ventilation grille of the air conditioner. Do not put fingers or any other things into the inlet/outlet and swing louver.
- Do not allow children to play with the air conditioner. In no case should children be allowed to sit on the outdoor unit.













Safety Precautions

- Before starting to use the system, read carefully this "SAFETY PRECAUTIONS" to ensure a proper operation of the system.
- Safety precautions described here are classified to " ⚠ WARNING" and " ⚠ CAUTION". Precautions which are shown in the column of " ⚠ WARNING" means that an improper handling could lead to a grave result like a death, serious injury, etc. However, even if precautions are shown in the column of " ⚠ CAUTION", a very serious problem could occur depending on situation. Make sure to observe these safety precautions faithfully because they are very important information to ensure the safety.
- Symbols which appear frequently in the text have following meanings.

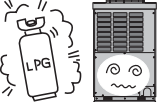

	Strictly prohibited.		Observe instructions faithfully.		Provide a positive grounding.
--	----------------------	---	----------------------------------	---	-------------------------------

When you have read through the manual, keep it always at hand for read consultation. If the operator is replaced, make sure to hand over this manual to the new operator.

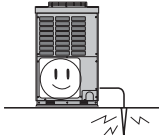
CAUTIONS FOR INSTALLATION













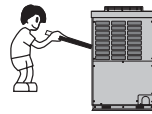



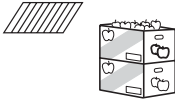

















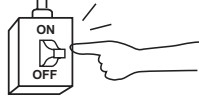





 WARNING		
<p>The system should be applied to places as office, restaurant, residence and the like.</p> <p></p> <p>Application to inferior environment such as an engineering shop, could cause equipment malfunction and serious injury or death.</p>	<p>The system should be installed by your dealer or a professional installer.</p> <p></p> <p>Installation by yourself is not encouraged because it could cause such problems as water leakage, electrical shock or fire accident by some improper handling.</p>	<p>When you need some optional devices such as a humidifier, electric heater, etc., be sure to use the products which are recommended by us. These devices should be attached by a professional installer.</p> <p></p> <p>Installation by yourself is not encouraged because it could cause such problems as water leakage, electrical shock or fire accident by some improper handling.</p>
 CAUTION		
<p>Do not install nearby the place where may have leakage of flammable gas.</p> <p> </p> <p>If the gas leaks and gathers around, it may cause the fire.</p>	<p>Depending on the place of installation, a circuit breaker may be necessary.</p> <p> </p> <p>Unless the circuit breaker is installed, it could cause electrical shocks.</p>	<p>Drain pipe should be arranged to provide a positive draining.</p> <p> </p> <p>If the pipe is arranged improperly, furniture or the likes may be damaged by leaked water.</p>
<p>Where strong winds may prevail, the system should be fixed securely to prevent a collapse.</p> <p></p> <p>Bodily injury could result by a collapse.</p>	<p>Install on the place where can endure the weight of air conditioner.</p> <p>Bodily injury could result by a careless installation.</p>	<p>Make sure the system is grounded.</p> <p> </p> <p>Grounding cable should never be connected to a gas pipe, city water pipe, lightning conductor rod or grounding cable of telephone. If the grounding cable is not set properly, it could cause electric shocks.</p>

CAUTIONS FOR TRANSFER OR REPAIR

 WARNING	
<p>Modification of the system is strictly prohibited. When the system needs a repair, consult your dealer.</p> <p></p> <p>Improper practice of repair could cause water leakage, electric shock or fire.</p>	<p>When the air conditioner is relocated, contact your dealer or a professional installer.</p> <p></p> <p>Improper practice of installation could cause water leakage, electric shock or fire.</p>

Safety Precautions

CAUTIONS FOR OPERATION

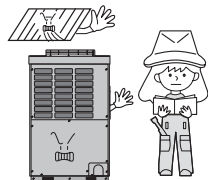
⚠ WARNING		
<p>You should refrain from exposing your body directly to cool wind for a long time.</p> <p> </p> <p>It could affect your physical condition or cause some health problems.</p>	<p>Do not poke the air inlet or outlet with a bar, etc.</p> <p> </p> <p>Since the internal fan is operating with a high speed, it could cause an injury.</p>	<p>When any abnormal condition (scorching smell or others) is found, stop the operation immediately and turn off the power switch. Then consult your dealer.</p> <p> </p> <p>If you continue the operation without removing the cause, it could result in a trouble, electric shock or fire.</p>
⚠ CAUTION		
<p>The system should never be used for any other purposes than intended such as for preservation of food, flora and fauna, precision devices or work of art.</p> <p> </p> <p>It could cause deterioration of food or other problems.</p>	<p>Do not handle switches with a wet hand.</p> <p> </p> <p>It could cause electric shocks.</p>	<p>Combustion apparatus should not be placed allowing a direct exposure to wind of air conditioner.</p> <p> </p> <p>Incomplete combustion could occur on the apparatus.</p>
<p>Do not wash the air conditioner with water.</p> <p> </p> <p>It could cause electric shocks.</p>	<p>Do not install the system where the air outlet reaches directly the flora and fauna.</p> <p> </p> <p>It will not be good for their health.</p>	<p>Make sure to use a fuse of proper electric rating.</p> <p> </p> <p>Use of steel or copper wire in place of a fuse is strictly prohibited because it could result in a trouble or fire accident.</p>
<p>Neither stand on the air conditioner nor place something on it.</p> <p> </p> <p>There are risks of falling or injury by collapsed object.</p>	<p>It is strictly prohibited to place a container of combustible gas or liquid near the air conditioner or to spray it directly with the gas or liquid.</p> <p> </p> <p>It could cause a fire accident.</p>	<p>Do not operate the system while the air outlet grill is removed.</p> <p> </p> <p>There is a risk of injury.</p>
<p>Do not use the power switch to turn on or off the system.</p> <p> </p> <p>It could cause a fire or water leakage.</p>	<p>Do not touch the air outlet section while the swing louver is operating.</p> <p> </p> <p>There is a risk of injury.</p>	<p>Do not use such equipment as a water heater, etc. around the indoor unit or the wire controller.</p> <p> </p> <p>If the system is operated at the vicinity of such equipment which generates steam, condensed water may drip during cooling operation or it could cause a fault current or short-circuit.</p>
<p>When operating the system simultaneously with a combustion apparatus, indoor air must be ventilated frequently.</p> <p> </p> <p>Insufficient ventilation could cause an oxygen deficiency accident.</p>	<p>Check occasionally the support structure of the unit for any damage after a use of long period of time.</p> <p> </p> <p>If the structure is not repaired immediately, the unit could topple down to cause a personal injury.</p>	<p>Do not place any objects on or climb on the unit.</p> <p> </p>
<p>When cleaning the system, stop the operation and turn off the power switch.</p> <p> </p> <p>Cleaning should never be done while the internal fans are running with high speed.</p>	<p>Do not put water containers on the unit such as a flower vase, etc.</p> <p> </p> <p>If the water enters into the unit and damages the electric insulation material, it may cause electric shock.</p>	<p>Do not try to repair or reconstruct by yourself.</p> <p> </p>

Safety Precautions

The machine is adaptive in following situation

1. Applicable ambient temperature range:

Cooling	Indoor	Maximum: D.B / W.B Minimum: D.B / W.B	32°C / 23°C 18°C / 14°C
	Outdoor	Maximum: D.B / W.B Minimum: D.B	43°C / 26°C 15°C
Heating	Indoor	Maximum: D.B Minimum: D.B	27°C 15°C
	Outdoor	Maximum: D.B / W.B Minimum: D.B / W.B	24°C / 18°C -7°C / -8°C

2. If the supply cord is damaged, it must be replaced by the manufacturer or its service agent or a similar qualified person.
3. If the fuse on [indoor unit](#) PC board is broken, please change it with the type of T. 3.15A /250V.
If the fuse on [outdoor unit](#) PC board is broken, please change it with the type of T. 6.3A /250V.
4. The wiring method should be in line with the local wiring standard.
5. The power cable and connecting cable are self-provided.
The power cable should be 5G 6.0mm².
The connecting cable should be 4G 1.5mm².
All the cables shall have got the European authentication certificate. During installation, when the connecting cables break off, it must be assured that the grounding wire is the last one to be broken off.
6. The breaker of the air conditioner should be all-pole switch; and the distance between its two contacts should be no less than 3mm.
7. The indoor unit installation height is at least 2.5m.

NOTE:

Installation and maintenance must be meet the local installation and [maintenance](#) instructions and should operate by the experienced special installation and maintenance technicians. [Otherwise](#) we don't take any duty of the units damage or injure to the person caused by improper operation.

WARNING!

- 1.The sharp edges and corners and coil surface have the danger to injury. [Please](#) avoid of them.
- 2.It's very danger to remove the units and power supply wire, because it can cause injury and death. Cut off all the power supply before [maintenance](#).

Parts and Functions

Indoor Unit

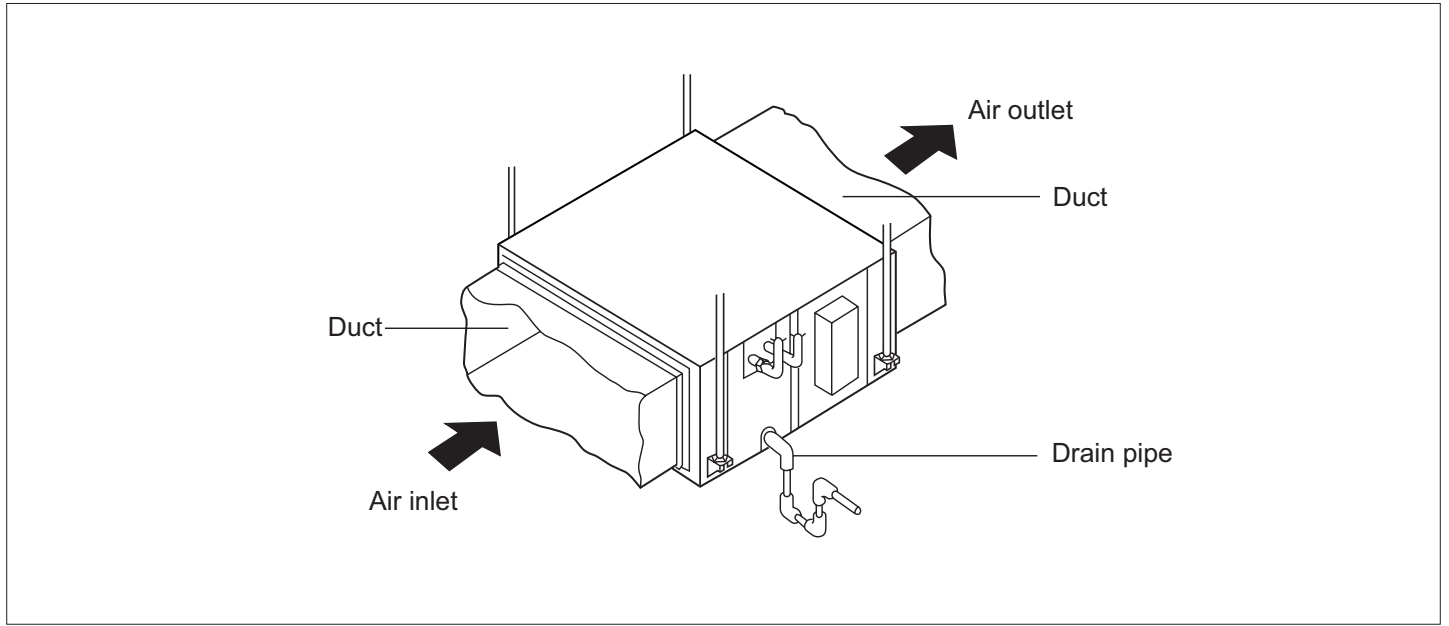

Outdoor Unit

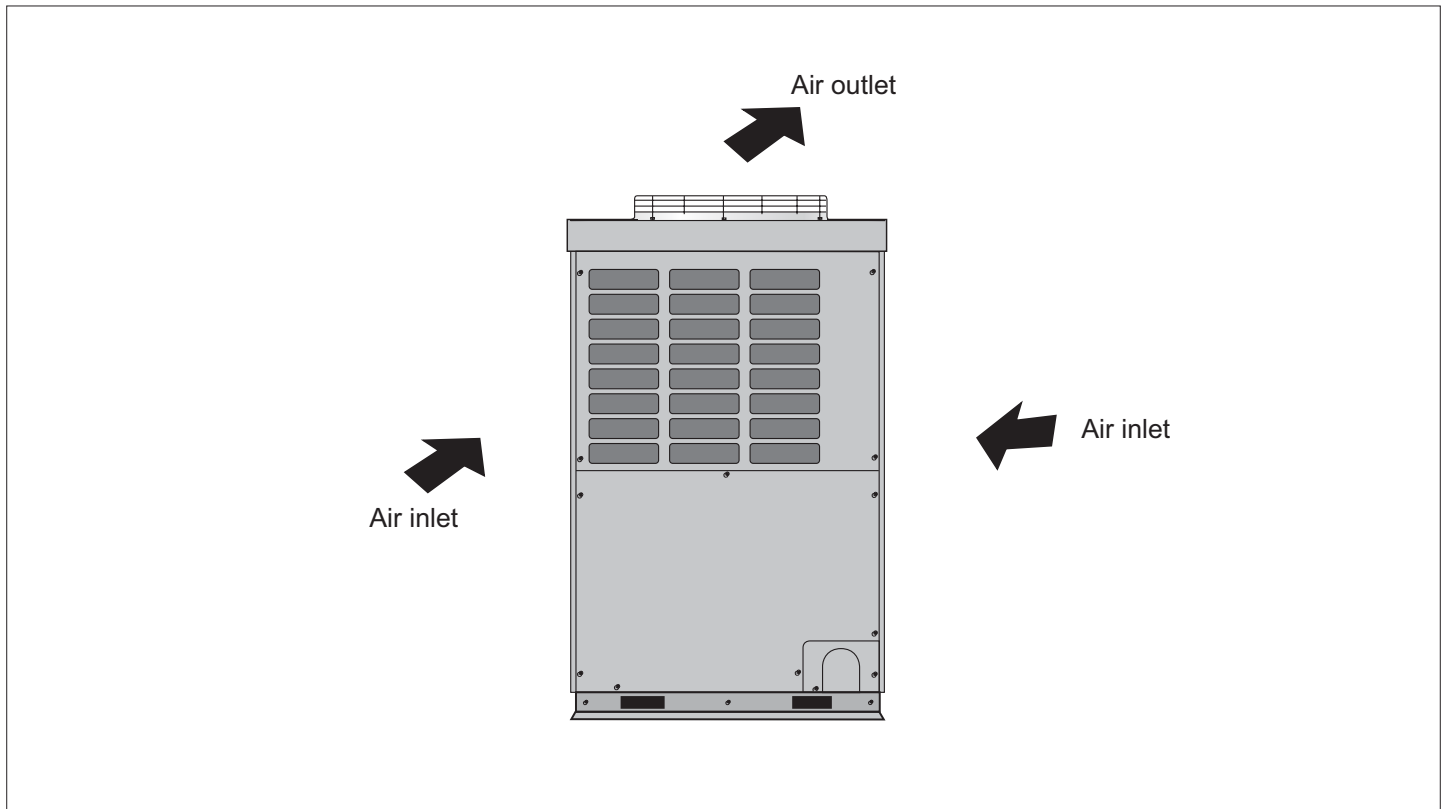

Heating Mode

"HOT KEEP" function

"HOT KEEP" is operated in the following cases.

- When heating is started:
In order to prevent blowing out of cool wind, the indoor unit fan stopped according to the room temperature which heating operation is started. Wait for approx. 2 to 3 minute, and the operation will be automatically changed to the ordinary heating mode.
- Defrosting operation (in the heating mode):
When it is liable to frost, the heating operation is stopped automatically for 5 to 12 minutes once per approx. one hour, and defrosting is operated. After defrosting is completed, operation mode is automatically changed to ordinary heating operation.
- When the room thermostat is actuated:
When room temperature increases and room temperature controller actuates, the fan speed is automatically changed to stop under low temperature condition of indoor heat exchanger. When room temperature decreases, air conditioner automatically changes over to ordinary heating operation.



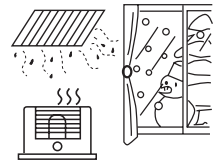

Warming Operation

- Heat pump type warming
With the heat pump type warming, the mechanism of heat pump that concentrate heat of outdoor air with the help of refrigerant to warm the indoor space, is utilized.
- Defrosting operation
When a room is warmed with a heat pump type air conditioner, frost accumulates on the heat exchanger of outdoor unit along with the drop of indoor temperature. Since the accumulated frost reduces the effect of warming, it is necessary to automatically switch the operation to the defrosting mode. During the defrosting operation, heating operation is interrupted.
- Atmospheric temperature and warming capacity
Warming capacity of heat pump type air conditioner decreases along with the drop of outdoor temperature. When the warming capacity is not sufficient, it is recommended to use another heating implement.
- Period of warm-up
Since the heat pump type air conditioner employs a method to circulate warm winds to warm the entire space of a room, it takes time before the room temperature rises. It is recommendable to start the operation a little earlier in a very cold morning.



Care and Maintenance

Points to observe

<p>Turn off the power supply switch.</p> 	<p>Do not touch with wet hand.</p> 	<p>Do not use hot water or volatile liquid.</p> 
--	--	---

CAUTION

- Do not open the inlet grill until fan stops completely.
- Fan will continue rotating for a while by the law of inertia after operation is being stopped.

Clean the air filter

1. Clean the air filter by lightly tapping it or with the cleaner. It is more effective to clean the air filter with water.
If the air filter is very dirty, dissolve neutral detergent in the lukewarm water (approx. 30 °C), rinse the air filter in the water, and thoroughly wash the air filter off the detergent in the plain water.
2. After drying the air filter, set it up on the air conditioner.

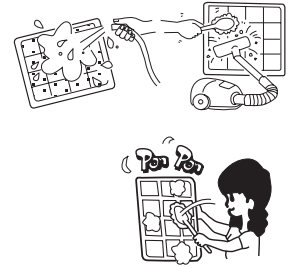

CAUTION

- Do not dry the air filter with fire.
- Do not run the air conditioner without the air filter.

Care and Cleaning of the unit

- Clean with soft and dry cloth.
- If it is very dirty, dissolve neutral detergent in the lukewarm water and make the cloth wet with the water.
After wiping, clean off the detergent using clean water.

Post-Season Care

- Operate the unit with FAN mode on a fair day for about half a day to dry the inside of the unit well.
- Stop operation and turn off the power supply switch. Electric power is consumed even the air conditioner is in stop.
- Clean the air filter and set it in the place.

Pre-Season Care

- See that there are no obstacles blocking the air inlet and air outlet of both indoor and outdoor units.
- Make sure that the air filter is not dirty.
 - Cut in the power supply switch 12 hours before starting run.

Troubleshooting

Please check the following things about your air conditioner before making a **service call**.

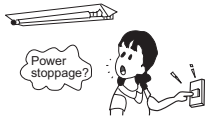
Unit fails to start			
<p>Is the power source switch adjust cut in?</p>  <p>Power supply switch is not ON.</p>	<p>Is city supply power in normal?</p> 	<p>Isn't the signal receiving section exposed to the direct sunlight or strong illumination?</p>	<p>Isn't the earth leakage breaker in action?</p> <p>It is dangerous. Turn off the power supply switch immediately and contact the sales dealer.</p>

Cooling or heating is not sufficient			
<p>Is the thermostat adjust as required?</p>	<p>Isn't the air filter dirty?</p>	<p>Isn't any doors or windows left open?</p>	<p>Doesn't any obstacle exist at the air inlet or outlet?</p>
<p>Isn't the swing louver horizontal? (At HEATING mode) If swing louver is horizontal, the blow wind does not reach floor.</p>			

Cooling is not sufficient			
<p>Isn't sun-shine invading direct?</p>	<p>Isn't any unexpected heating load generated?</p>	<p>Isn't the room much crowded?</p>	<p>The wind does not blow during heating operation Isn't it warming up?</p>

When the air conditioner does not operate properly after you have checked the above mentioned items or when the following phenomenon is observed, stop the operation of the air conditioner and contact your sales dealer.



- The fuse or breaker often shuts down.
- Water drops off during cooling operation.
- There is a irregularity in operation or abnormal sound is audible.
- When the CHECK lamp (red) flickers, an irregularity has occurred in the air conditioner.

Note:

This unit has a function of automatic restart system after recovering power stoppage. Please contact the sales dealer if it is not required.

Troubleshooting

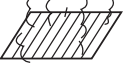
The followings are not malfunction

<p>Water flowing sound is heard.</p> 	<p>When the air conditioner is started, when the compressor starts or stops during operation or when the air conditioner is stopped, it sometimes sounds "shuru shuru" or "gobo gobo". It is the flowing sound of the refrigerant, and it is not a trouble.</p>
<p>Cracking sound is heard.</p>	<p>This is caused by heat expansion or contraction of plastics.</p>
<p>It smells.</p>	<p>Air which blows out from the indoor unit sometimes smells. The smell results from residents of tobacco smoke or cosmetics stuck inside of unit.</p>
<p>During operation, white fog comes out of indoor unit.</p> 	<p>When the air conditioner is used at restaurant etc. where dense edible oil fume always exists, white fog sometimes blows out of air outlet during operation. In this case consult sales dealer for cleaning the heat exchanger.</p>
<p>It is switched into the FAN mode during cooling.</p>	<p>To prevent frost from being accumulated on the indoor unit heat exchanger, it is sometimes automatically switched to the FAN mode but it will soon return to the cooling mode.</p>
<p>The air conditioner can not be restarted soon after it stops.</p> 	<p>Even if the operation switch is turned on, cooling, dehumidifying or heating is not operable for three minutes after the conditioner is stopped. Because the protecting circuit is activated. (During this time air conditioner operates in fan mode.)</p> 
<p>Air does not blow or the fan speed can not be changed during dehumidifying</p>	<p>When it is excessively cooled during dehumidifying, the blower automatically repeats reducing and lowering the fan speed.</p>
<p>During operation, operation mode has changed over automatically.</p>	<p>Isn't the AUTO mode selected? In the case of AUTO mode, operation mode is changed automatically from cooling to heating or vice-versa according to the room temperature.</p>
<p>Water or steam generates from the outdoor unit during heating.</p>	<p>This results when frost accumulated on the outdoor unit is removed (during defrosting operation).</p>

Troubleshooting

Diagnosis for On-Off models

Flash times for remote type	Failure code on wired controller	Failure code for central control	Failure description	Reason	Remarks
1	01(01H)	01D	Indoor ambient temp. sensor failure	Sensor broken down or short circuit for more than 2min continuously	○
2	02(02H)	02D	Indoor coil temp. sensor failure	Sensor broken down or short circuit for more than 2min continuously	○
3	74(4AH)	11D	Outdoor ambient temp. sensor failure	Sensor broken down or short circuit for more than 2min continuously	○
4	73(49H)	12D	Outdoor coil temp. sensor failure/ Compressor discharging temp. sensor abnormal	Sensor broken down or short circuit for more than 2min continuously	○
5	72(48H)	10D	Over-current protection / Power supply abnormal	CT check abnormal 3 times in 30min / Fault phase, short of phase, out of balance greatly	✕
6	83(53H)	14D	High/Low pressure abnormal	High pressure switch acts 3 times in 30min/Low pressure switch acts in normal running	✕
8	07(07H)	06D	Communication between wired controller and indoor abnormal	Communication abnormal for more than 4min continuously	○
9	06(06H)	05D	Communication between indoor and outdoor abnormal	Communication abnormal for more than 4min continuously	○
10	08(08H)	21D	Drainage system abnormal	Float switch broken down for more than 25min continuously	○
11	11(0BH)	30D	Outside alarm signal input	Outside signal broken down for more than 10s	○
12	03(03H)	20D	Gas pipe temp. sensor abnormal	Sensor broken down or short circuit for more than 2min continuously	○
13	13(0DH)	31D	Temperature protection malfunction	Solenoid valve act incorrectly 3 times continuously	✕
15	05(05H)	17D	EEPROM abnormal	EEPROM data missing	○
17	80(50H)	15D	Compressor overheat	The discharging temperature is higher than 120degree	○ Resumable if lower than 100 degree
18	12(0CH)	23D	Abnormal mode	Indoor operation mode is different with the running indoor unit.	○
19	75(4BH)	18D	Outdoor coil B(suction temp sensor-for MRV II)	Sensor broken down or short circuit for more than 2min continuously	○
20	77(4DH)	15D	Outdoor discharging B(oil temp sensor-for MRV II)	Sensor broken down or short circuit for more than 2min continuously	○

○ shows resumable fault, ✕ shows it is not resumable fault.

Precaution for Installation

Safety precautions

- Please read these "Safety Precautions" first then accurately execute the installation work.
- Though the precautionary points indicated herein are divided under two headings, ⚠ WARNING and ⚠ CAUTION, those points which are related to the strong possibility of an installation done in error resulting in death or serious injury are listed in the ⚠ WARNING section. However, there is also a possibility of serious consequences in relationship to the points listed in the ⚠ CAUTION section as well. In either case, important safety related information is indicated, so by all means, properly observe all that is mentioned.
- After completing the installation, along with confirming that no abnormalities were seen from the operation tests, please explain operating methods as well as maintenance methods to the user (customer) of this equipment, based on the owner's manual. Moreover, ask the customer to keep this sheet together with the owner's manual.

⚠ WARNING

- This system should be applied to places as office, restaurant, residence and the like. Application to inferior environment such as engineering shop could cause equipment malfunction.
- Please entrust installation to either the company which sold you the equipment or to a professional contractor. Defects from improper installations can be the cause of water leakage, electric shocks and fires.
- Execute the installation accurately, based on following the installation manual. Again, improper installations can result in water leakage, electric shocks and fires.
- When a large air-conditioning system is installed to a small room, it is necessary to have a prior planned countermeasure for the rare case of a refrigerant leakage, to prevent the exceeding of threshold concentration. In regards to preparing this countermeasure, consult with the company from which you purchased the equipment, and make the installation accordingly. In the rare event that a refrigerant leakage and exceeding of threshold concentration does occur, there is the danger of a resultant oxygen deficiency accident.
- For installation, confirm that the installation site can sufficiently support heavy weight. When strength is insufficient, injury can result from a falling of the unit.
- Execute the prescribed installation construction to prepare for earthquakes and the strong winds of typhoons and hurricanes, etc. Improper installations can result in accidents due to a violent falling over of the unit.
- For electrical work, please see that a licensed electrician executes the work while following the safety standards related to electrical equipment, and local regulations as well as the installation instructions, and that only exclusive use circuits are used.
- Insufficient power source circuit capacity and defective installation execution can be the cause of electric shocks and fires.
- Accurately connect wiring using the proper cable, and insure that the external force of the cable is not conducted to the terminal connection part, through properly securing it. Improper connection or securing can result in heat generation or fire.
- Take care that wiring does not rise upward, and accurately install the lid/service panel. Its improper installation can also result in heat generation or fire.
- When setting up or moving the location of the air conditioner, do not mix air etc. or anything other than the designated refrigerant (R410A) within the refrigeration cycle.
Rupture and injury caused by abnormal high pressure can result from such mixing.
- Always use accessory parts and authorized parts for installation construction. Using parts not authorized by this company can result in water leakage, electric shock, fire and refrigerant leakage.



⚠ CAUTION

- Execute proper grounding. Do not connect the ground wire to a gas pipe, water pipe, lightning rod or a telephone ground wire. Improper placement of ground wires can result in electric shock.
- The installation of an earth leakage breaker is necessary depending on the established location of the unit. Not installing an earth leakage breaker may result in electric shock.
- Do not install the unit where there is a concern about leakage of combustible gas.
The rare event of leaked gas collecting around the unit could result in an outbreak of fire.
- For the drain pipe, follow the installation manual to insure that it allows proper drainage and thermally insulate it to prevent condensation. Inadequate plumbing can result in water leakage and water damage to interior items.

Is the Unit Installed Correctly

Confirm the following items for safe and comfortable use of air conditioner.

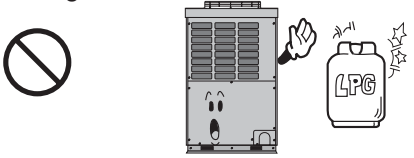
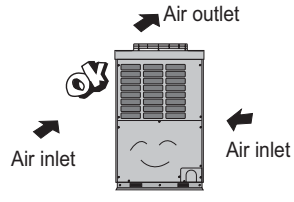
The installation work is to be burden on the sales dealer, and do not conduct it by yourself.

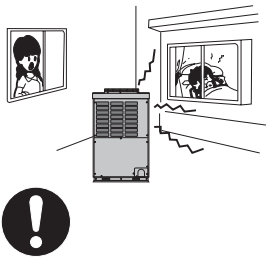
Installation place		
<p>Avoid installing the air conditioner near the place where possibility of inflammable gas leakage exists.</p>  <p>Explosion (Ignition) may occur.</p>	<p>Install the unit at well ventilated place.</p>  <p>If some obstacle exist, it may cause capacity reduction or noise increase.</p>	<p>Install the air conditioner firmly on the foundation that can fully support the weight of the unit.</p>  <p>If not, it may cause vibration or noise.</p>
<p>Select the place so as not to annoy neighbor with the hot air or noise.</p> 	<p>Snow protection work is necessary where outdoor unit is blocked up by snow.</p> <p>For details consult your sales dealer.</p>	<p>It is advisable not to install the air conditioner at the following special place. It may cause malfunction, consult the sales dealer when you have to install the unit on such a place.</p> <ul style="list-style-type: none"> • The place where corrosive gas generates (Hot spring area etc.) • The place where salt breeze blows (Seaside etc.) • The place where dense soot smoke exists • The place where humidity is extraordinarily high • The place where near the machine which radiates the electromagnetic wave • The place where voltage variation is considerably large

Electric work

The electric work must be burden on the authorized engineer with qualification for electric work and grounding work, and the work must be conducted in accordance with electric equipment technical standard.

- The power source for the unit is to be of exclusive use.
- An earth leakage breaker should be installed. (This is necessary to prevent electric shock.)
- The unit must be grounded.

When you change your address or the installation place

Special technology is required for removal or reinstallation of air conditioner, consult the sales dealer. Besides, construction expense is charged for removal or reinstallation.

For inspection and maintenance

The capacity of air conditioner will decrease by contamination of inside of unit when it is used for about three years although depending upon the circumstances under which it is used, and so in addition to the usual maintenance service, special inspection/maintenance service is necessary. It is recommended to make a maintenance contract (charged) by consulting your sales dealer.

NOTE

All Wiring of this installation must comply with NATIONAL, STATE AND LOCAL REGULATIONS. These instructions do not cover all variations for every kind of installation circumstance. Should further information be desired or should particular problems occur, the matter should be referred to your local distributor.

WARNING

BE SURE TO READ THESE INSTRUCTIONS CAREFULLY BEFORE BEGINNING INSTALLATION. FAILURE TO FOLLOW THESE INSTRUCTIONS COULD CAUSE SERIOUS INJURY OR DEATH, EQUIPMENT MALFUNCTION AND/OR PROPERTY DAMAGE.

1. Before installation (Before finishing installation, do not throw the attached parts installation needs)

- Confirm the way to move the unit to the installation place.
- Before moving the unit to the installation place, do not remove their packages. When having to remove the package, use a soft material or protection board with rope to lift the unit assembly to avoid unit damage or bumping a scrape.

2. Selecting the installation place

(1) The chosen installation place should meet the following requirements and get the user's consent.

- Place ensures ideal airflow distribution.
- The passage of airflow has no obstacles.
- When importing outside air, it should be imported directly from outdoors. (if the pipe can not be extended, it also can not be imported from top)
- Place ensures enough space for maintenance.
- The pipe length between indoor and outdoor unit is in the permitted limit (referring to outdoor unit installation part).
- The indoor unit, outdoor unit, electric wire and connection wire is at least 1m away from television and radio. This is to avoid the image disturbance and noise caused by the above-mentioned home appliance. (Even if 1m away, if the electromagnetic wave is too strong, it can also cause noise.)

(2) The height of ceiling

- The indoor unit can install on the ceiling, which height is no more than 3m.

(3) Install and use the hoisting screw. Check if the installation place can bear the weight of unit assembly. If not certain, strengthen it before install the unit.



3. Preparation before installation

(1) The position relation among hoisting screw (unit: mm)

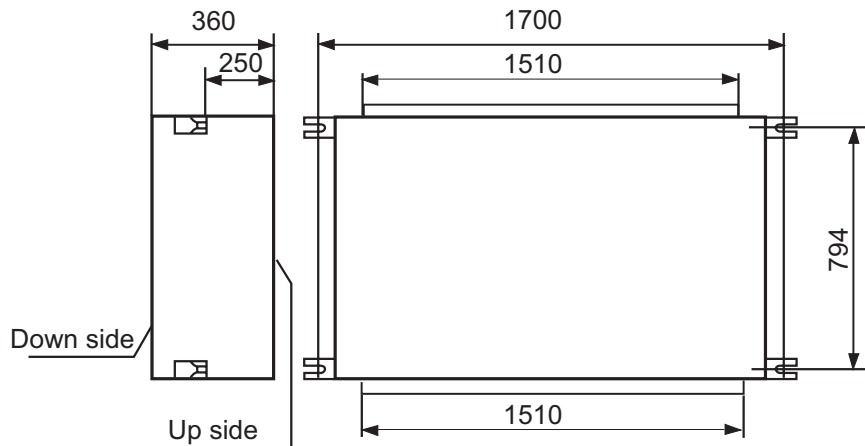

(2) If necessary, cut the opening installation and checking needed on the ceiling. (If has ceiling)

- Before installation, finish the preparation work of all the pipes (refrigerant, drainage) and wire (wire controller connection wire, indoor and outdoor unit connection wire) of indoor unit, so that after installation, they can be immediately connected with outdoor unit.
- Cut the opening on the ceiling. Maybe it needs to strengthen the ceiling to keep the ceiling even and flat and prevent the ceiling from vibration. For details, please consult to the builder.

(3) Hanger bolts installation

- Use care of the piping direction when the unit is installed. (Use M10 screw bolt)
- In order to bear the weight of the unit, for existed ceiling, using foundation screw bolt; For new ceiling, using burying embedded screw bolt, burying screw bolt or spot supplied other parts.
- Before going on installation, adjust the gaps with ceiling.

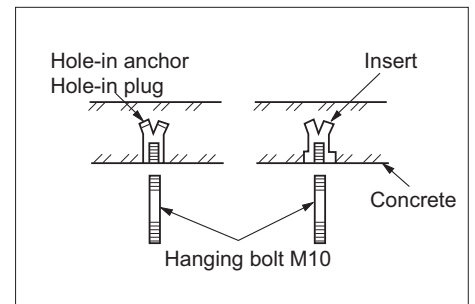

4. Installing indoor unit

Fix the indoor unit to the hanger bolts.

If required, it is possible to suspend the unit to the beam, etc. Directly by use of the bolts without using the hanger bolts.

Note

When the dimensions of main unit and ceiling holes does not match, it can be adjusted with the slot holes of hanging bracket.

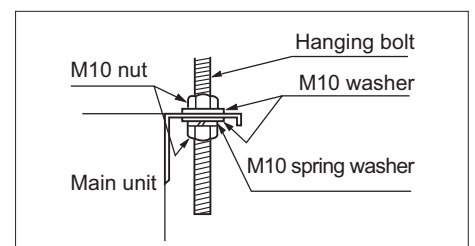

Adjusting to the levelness

(a) Adjust the out-of levelness using a level or by the following method.

Make adjustment so that the relation between the lower surface of the unit proper and water level in the hose becomes as given below.

(b) Unless the adjustment to the levelness is made properly, malfunctioning or failure of the float switch may occur.

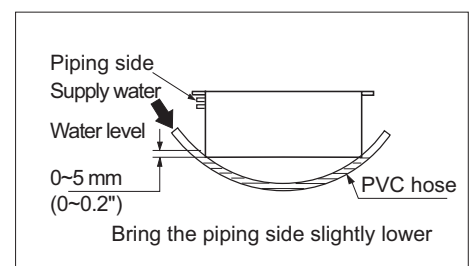

5. Drain Piping

(a) Drain piping should always be in a downhill grade (1/50~1/100) and avoid riding across an elevation or making traps.

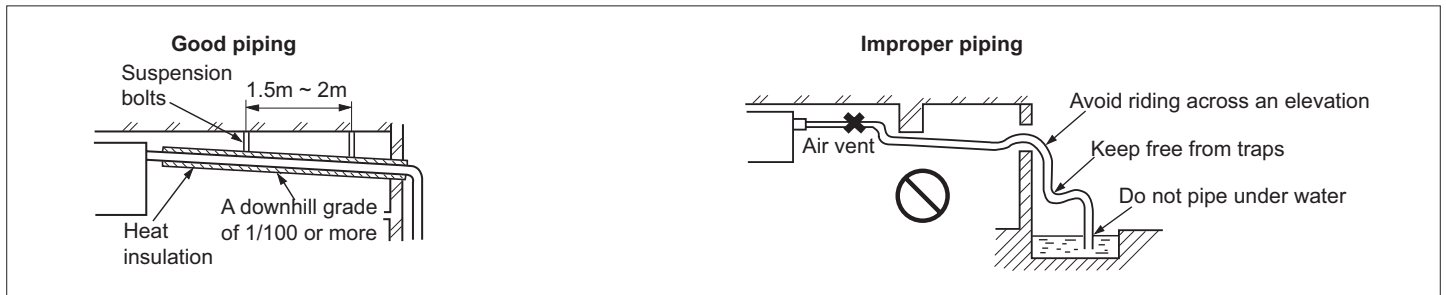

(b) When connecting the drain pipe to unit, pay sufficient attention not to apply excess force to the piping on the unit side. Also, fix the piping at a point as close as possible to the unit.

(c) For drain pipe, use hard PVC general purpose pipe VP-25(I.D.1") which can be purchased locally. When connecting, insert a PVC pipe end securely into the drain socket before tightening securely using the attached drain hose and clamp. Adhesive must not be used connection of the drain socket and drain hose (accessory).

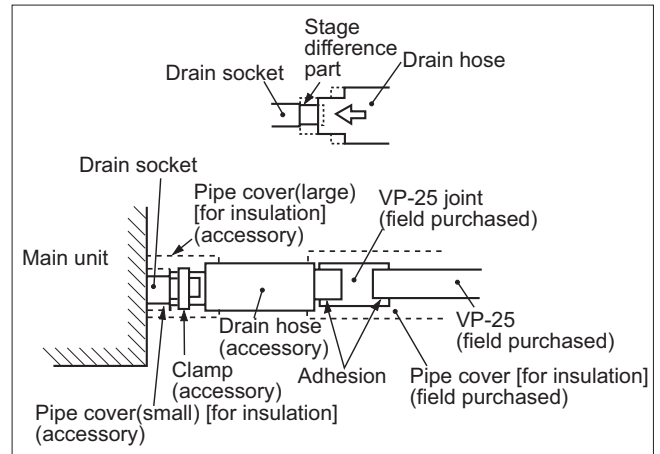

(d) When constructing drain piping for several units, position the common pipe about 100 mm below the drain outlet of each unit as shown in the sketch. Use VP-30(1 1/4") or thicker pipe for this purpose.

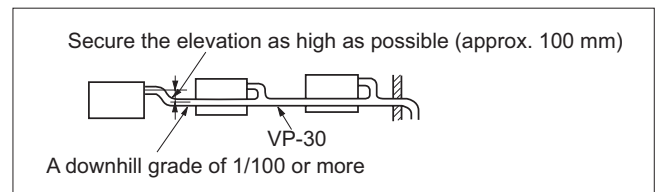

(e) The stiff PVC pipe put indoor side should be heat insulated.

(f) Avoid putting the outlet of drain hose in the places with irritant gas generated. Do not insert the drain hose directly into drainage, where the gas with sulfur may be generated.

(g) Set a backwater bend in the middle of drain hose as figure shown.

Because the drain spout is at the position, which negative pressure may occur. So with the rise of water level in the drain pan, water leakage may occur. In order to prevent water leakage, we designed a backwater bend.

The structure of backwater bend should be able to be cleaned. As the right figure shown, use T type joint. The backwater bend is set near the air conditioner.

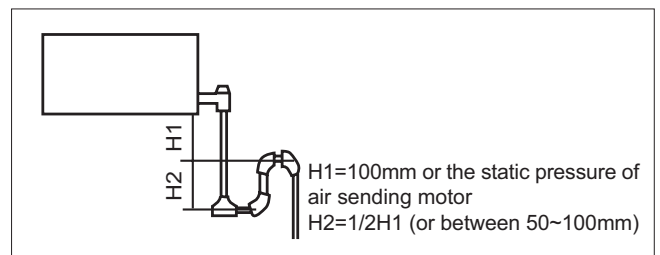

Drainage Test

- (1) Conduct a drainage test after completion of the electrical work.
- (2) During the trial, make sure that drain flows properly through the piping and that no water leaks from connections.
- (3) In case of a new building, conduct the test before it is furnished with the ceiling.
- (4) Be sure to conduct this test even when the unit is installed in the heating season.

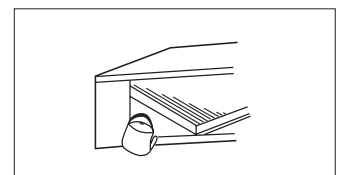

Procedures

- (1) Supply about 1000 cc of water to the unit through the air outlet using a feed water pump.
- (2) Check the drain while cooling operation.

6. Installation of air suction and discharging duct

Please consult the after-sales service [personnel](#) for the choosing and installation of suction inlet, suction duct, discharging outlet and discharging duct. Calculating the design drawing and outer static pressure, and choose the discharging duct with proper length and shape.

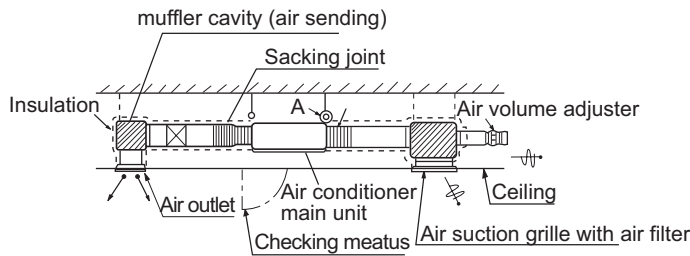

Enlarging chart of profile chart A

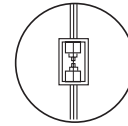

Vibration resistance hook

- The length difference among every duct is limited below 2:1.
- Reduce the length of duct as possible as can.
- Reduce the amount of bend as possible as can.
- Use heat insulation material to bind and seal the part connecting main unit and the flare part of air discharging duct. Perform duct installation work, before the fitment of ceiling.

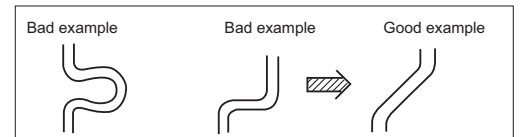

7. Calculation method of the dimension of the simple quadrate air duct

Presuming the unit length friction impedance of the duct is 1Pa/m, when the dimension of one side of the air duct is fixed as 250mm, as shown below:

AD842AHEAA		
	Air volume	Duct
A	2400m ³ /h(40m ³ /min)	250x560(mm xmm)
B	600m ³ /h(10m ³ /min)	250x190(mm xmm)

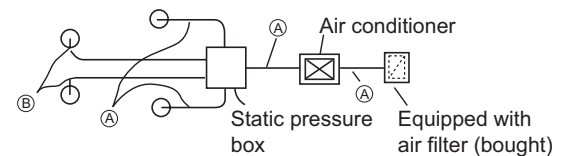

The calculation of duct resistance (the simple calculation is as follow table)

Straight part	Calculate as per 1m length 1Pa, 1Pa/m
Bend part	Each bend takes as a 3~4m long straight duct
Air out part	Calculate as 25Pa
Static pressure box	Calculate as 50Pa/each
Air inlet grille (with air filter)	Calculate as 40Pa/each

The chosen chart of simple duct

Note: 1Pa/m=0.1mmAg/m

Shape	Square duct
Air volume m ³ /h(m ³ /n)	Dimension (mm xmm)
100	250 x 60
200	250 x 90
300	250 x 120
400	250 x 140
500	250 x 170
600(10)	250 x 190
800	250 x 230
1,000	250 x 270
1,200(20)	250 x 310
1,400	250 x 350
1,600	250 x 390

Shape	Square duct
Air volume m ³ /h(m ³ /n)	Dimension (mm xmm)
1,800(30)	250 x 430
2000	250 x 470
2400	250 x 560
3,000(50)	250 x 650
3,500	250 x 740
4,000	250 x 830
4,500	250 x 920
5,000	250 x 1000
5,500	250 x 1090
6,000(100)	250 x 1180

8. The attentive matters in installation of air suction and discharging duct

- Recommend to use anti-frost and sound-absorbing duct. (locally bought)
- The duct installation work should be finished before the fitment of ceiling.
- The duct must be heat insulated.
- The specific air-discharging outlet should be installed at the place where the airflow can be reasonably distributed.
- The surface should leave a checking meatus for checking and maintenance.

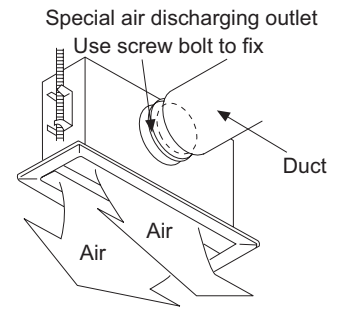

9. The examples of improper installation

- Do not use air in duct and take the ceiling inner side instead. The result is because of the irregular outer air mass, strong wind and sunshine, the humidity is increased.
- There may be water drop on the outside of duct. For cement and other new constructions, even if not taking ceiling inner side as duct, the humidity will also be so high. At this time, use glass fiber to perform heat preservation to the whole. (use iron net to bind the glass fiber)
- Maybe exceeding the unit operation limit (for example: when indoor dry bulb temperature is 35°C, wet bulb temperature 24°C), it may lead to overload of compressor.
- Affected by the capacity of air discharging fan, the strong wind in the outer duct and wind direction, when unit air sending volume exceeds the limit, the discharged water of heat exchanger will overflow, leading to water leakage.

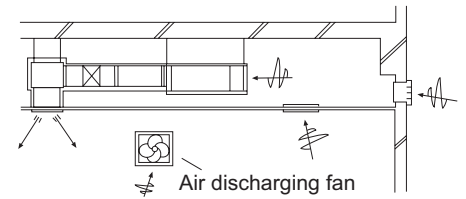

Improper example

11. Refrigerant pipe

The air side pipe, liquid side pipe must be faithfully heat insulated, if no heat insulation, it may cause water leakage.

- The outdoor unit has been charged with refrigerant.
- When connect the pipe to the unit or dismantling the pipe from the unit, please follow the figure shown, use spanner and torque spanner together.
- When connect cone nut, the inner side and outside of cone nut should paste with refrigerant oil. Use hand to twist 3-4 rings, then fasten with spanner.
- Referring to Table I to confirm the fasten torque. (too tight may damage nut leading to leakage)
- Check if the connection pipe leaks, then do heat insulation treatment, as below figure shown.
- Only use seal cushion to bind the joint part of air pipe and heat insulation parts.

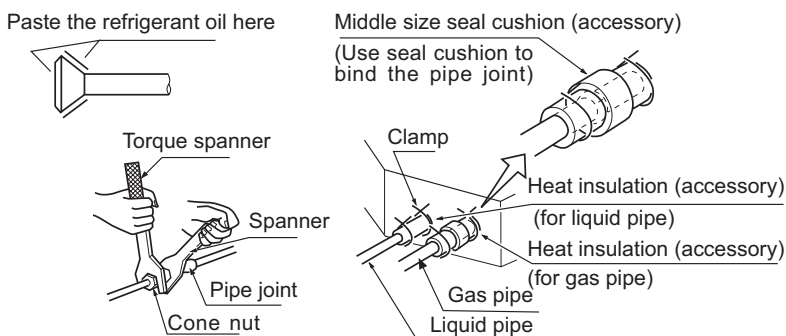
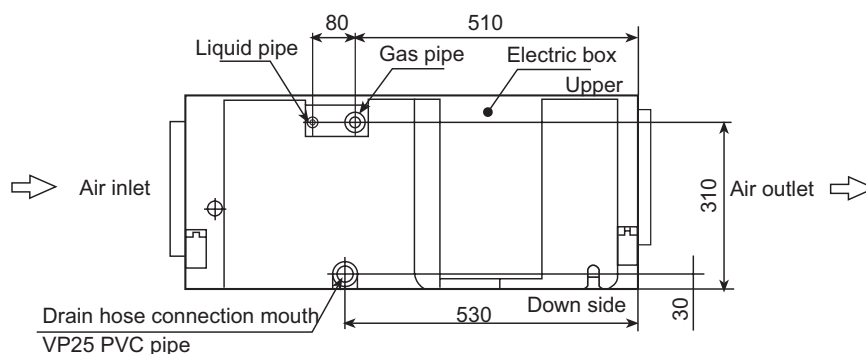

Table I

Specification of pipe	Tighten torque	Cone dimension A (mm)	Cone
Φ 12.7mm	50 N.m	1.2~2.0	



1. Selecting the installation place

Warning

- It should be installed at places where it is firm enough to withstand the weight of the air conditioner to prevent falling.
- Typhoon and earthquake prevention. It should be installed according to specific requirements. **Inappropriate** installation may lead to accidents.

Dimension of outdoor unit

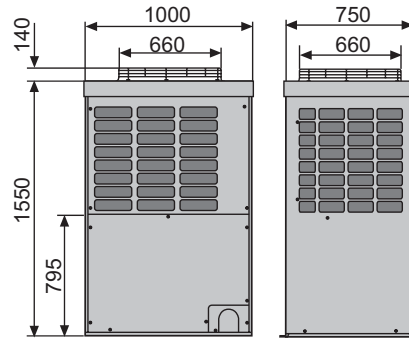

Installation space

(1) During installation, connect the outdoor unit and align the mounting surface (See the figure on the right). Mount the electric distribution device on the external side of the unit in accordance to the installation instructions for electric distribution device.

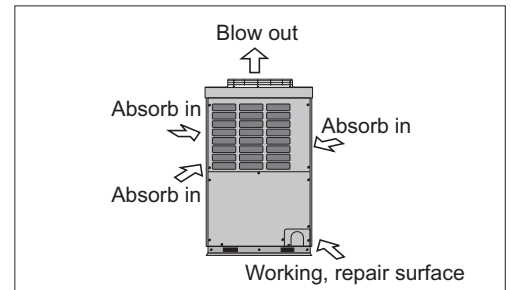

(2) To ensure good performance of the machine and facilitate installation and maintenance, adequate space must be reserved (See figure on the right).

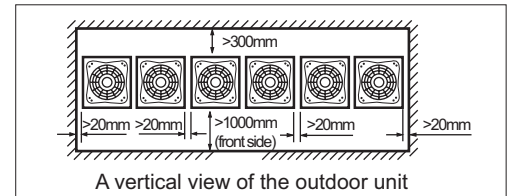

Note:

Obstacles should be 2000mm off the top of the outdoor unit. Obstacles nearby should be 400mm lower than the top of the unit.

2. Delivery of outdoor unit

As there is no protective package for the outdoor unit, so the following points merit attention:

- (1) When forklift is used, insert the fork into the holes in the base plate.
- (2) When crane is used, lift the unit with 4 pieces of steel rope with diameter above 6 mm.
- (3) Put protective materials between the cable and the unit to prevent deformation and damage of the surface.

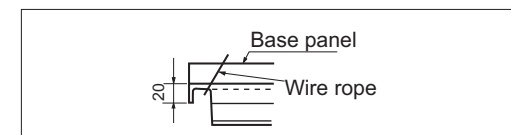
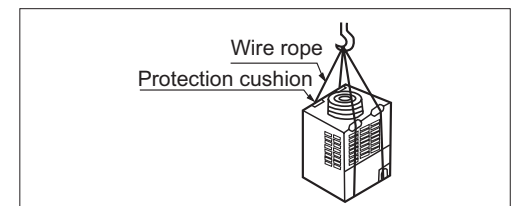

3. Mounting outdoor unit

(1) The distance between two connections must not be less than 20mm.

- Refer to the following figure for the distance between the foundation bolts.



(2) When the refrigerant pipe is connected from the bottom of the unit, the unit should be raised at least 500mm (see the figure right)

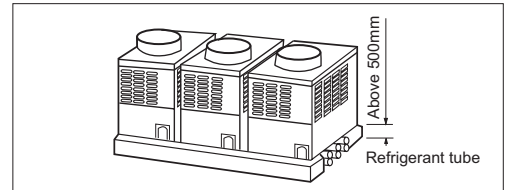

(3) In snowy regions, snow-proof facilities should be used (see the figure right). (Poor snow-proof facilities may lead to **damage**. To avoid inconveniences, the unit should be raised and snow-proof covers should be installed at the air inlet and outlet.)

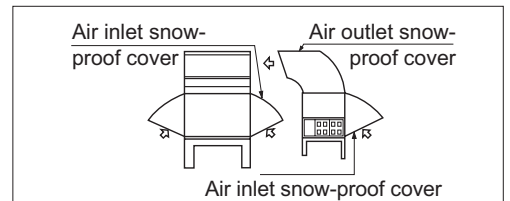

(4) During installation, anti-vibration rubber pads should be used between the machine and the bracket.

4. Connection of refrigerant pipe

Warning

- During installation, if refrigerant leakage occurs, ventilation measures must be taken. When refrigerant meets with fire, hazardous gas will be produced.
- After installation, make sure that there is no refrigerant leakage. Refrigerant, if meeting with heaters and stoves, ect. in the room, may produce hazardous gas.

Connection of refrigerant pipe

- (1)The joints of the refrigerant pipe are inside the unit. Take off the access hole cover in front of the unit.
- (2)The pipe can be connected from the front or bottom of the outdoor unit.
- (3)Remove the L-shaped pipe from the valve by welding and connect the accessory pipe to the valve.
- (4)In the case of front connection, cut the accessory pipe at the height of the fixing panel. Then join the pipe with an elbow and let it go through the fixing panel. For the convenience of maintenance, bend the pipe down (once) and then connect pipe to the right or left.
- (5)In the case of bottom connection, join the pipe with accessory pipe through the holes in the base plate of the outdoor unit, and connect pipe the left or right or the back.
- (6)During welding, the gas pipe valve must be cooled down with a wet cotton cloth.
- (7)The maximum connection pipe is 50 meters, the maximum drop difference between indoor unit and outdoor unit is 30 meters.
- (8)It should install the liquid check-ring and accumulator according to the outdoor unit and indoor unit position.(see the following figures)

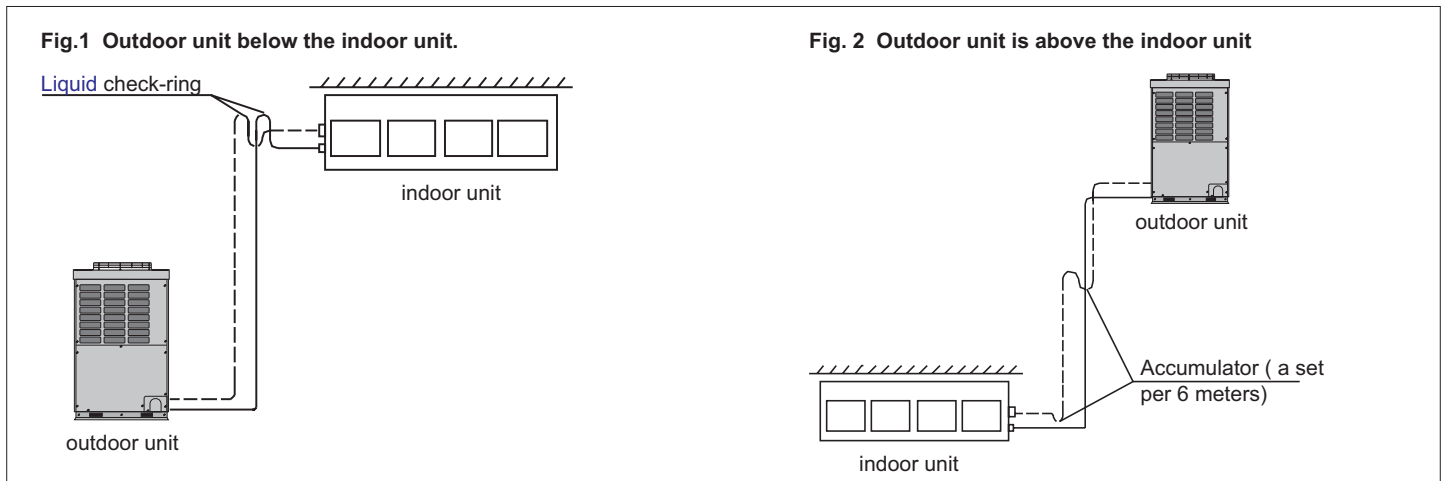
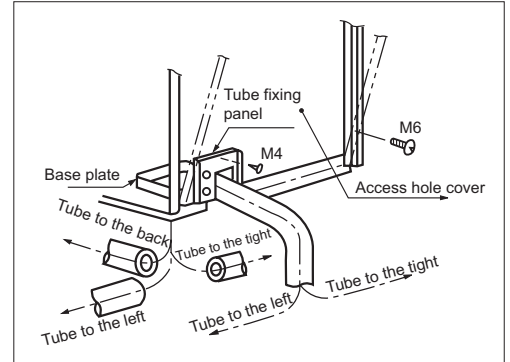

During welding of the distribution pipe

- (1).In case of brazing weld of joint, nitrogen must be filled in the pipe to prevent oxidization.
- (2).The refrigerant pipe should be newly-made and clean. During installation, do not let water and other substance into the pipe.
- (3).Use two spanners to tighten the connecting nut. One spanner will make loose connection.
- (4).The torque moment should conform to the specified value. (Refer to the below)

Torque moment for tightening the nut

Tube diameter (mm)	Torque moment for pre-installation (N.m)	Torque moment for tightening up (N.m)
Ø 12.70	49.0(5.0kgf·m)	53.9(5.5kgf·m)

5. Outdoor unit pipelines connection

According to the pipeline connection method, connect the distribute pipes and inlet & outlet liquid pipes.

6. Leak Test

- Leak test must be made after connection of the refrigerant pipe according to the following diagram.
- Close all the gas and liquid valves. To prevent nitrogen gas from invading the outdoor circulating system, close the valve tightly before pressure increase. (Both the gas and liquid valves must be tightly closed.)
- Every cooling system must be charged slowly from the gas and liquid valves.
- It must be charged from the gas and liquid valves.

Note:

Never use oxygen, flammable and poisonous gases for the leak test.

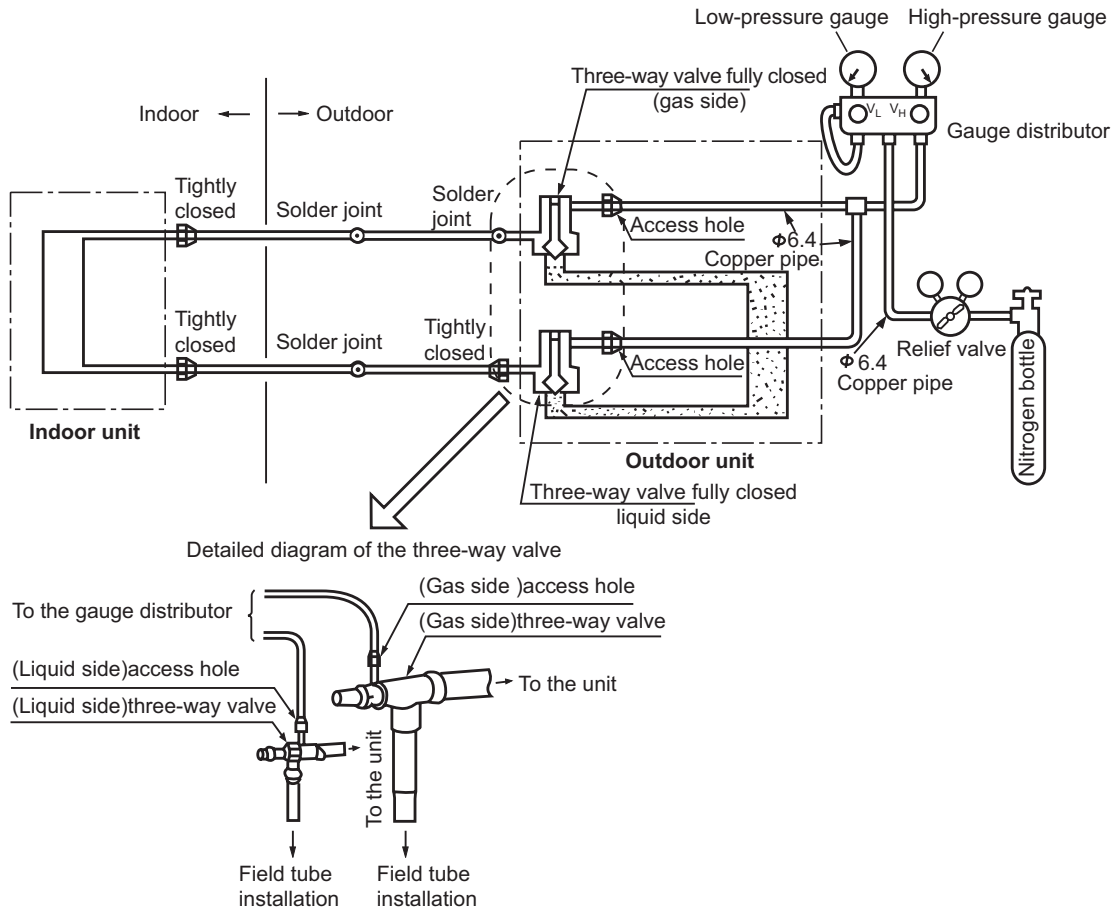

- (1) Pressurize for more than 3 minutes under 0.3MPa(3.0kg/cm²g)
- (2) Pressurize for more than 3 minutes under 1.5MPa(15kg/cm²g). Serious leakage may be found.
- (3) Pressurize for more than 24 hours under 3.0MPa(3.0kg/cm²g). Small leakage may be found.

• Check if the pressure decrease

If the pressure does not decrease, then the test passes.

If the pressure decrease, check for **leakage**.

There will be a 0.01MPa(0.1kg/cm²g) pressure change for every 1°C ambient temperature change during the 24-hour pressure charge. It should be corrected during the test.

• Check for leakage

In the case of pressure decrease during steps (1) to (3), check the joints with the ear, hand or soapsuds for leakage. Repair it by welding or tighten the connecting nut up.

7. Pipe Vacuumizing

- Use vacuum pump to evacuate the air. Never use the refrigerant for the evacuation.
- Drain off the nitrogen gas after the leak test and then connect the vacuum pump as shown in the figure below.
- The vacuum pumping must be done from both the liquid and gas inlets.

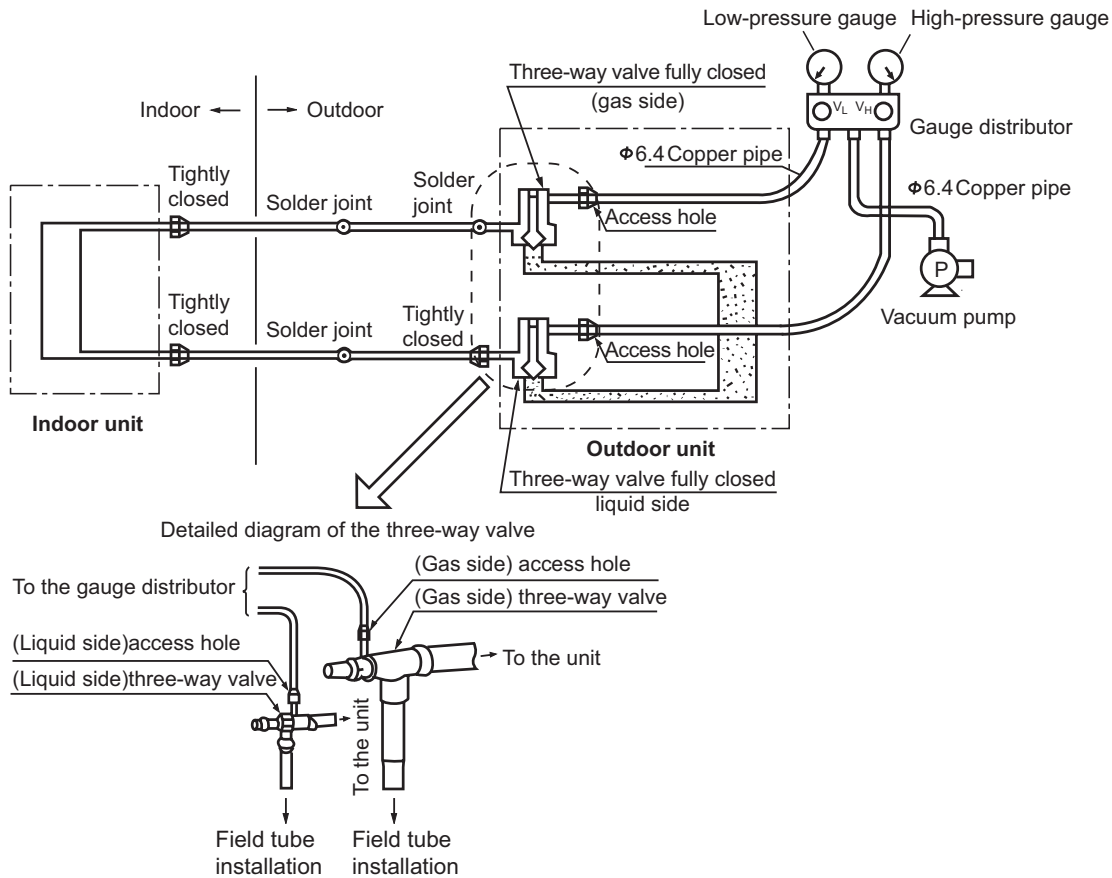

- Use a vacuum pump with high degree of vacuum (below 755mmHg) and large volume displacement (above 40L/min).
- The pumping time depends on the length of the connecting pipe. Generally, it takes about 2-3 hours. Make sure that the Y-shaped valves on both the gas and liquid sides are closed before pumping.
- If the vacuum can no reach 755mmHg within 2 hours, continue pumping for another 1 hour.
- If the vacuum can no reach 755mmHg after more than 2 hour's pumping, close the valves V_L and V_H on the gauge distributor and stop pumping. One hour later, check the vacuum again. If the vacuum has changed, it means there is a leakage. Repair it.
- After the above steps, replace the vacuum pump with the refrigerant pump and refill refrigerant.

8. Refrigerant charge

After finished vacuum the system, change the vacuum to the refrigerant pump, charging the refrigerant.

Calculation of the the refrigerant charge

When the unit ships out of the factory, charge the refrigerant not including the construction procedure charged parts.

The calculation of the refrigerant charging:

When the connection pipe (L) \leq 5 meters, not need to add refrigerant ;

When the connection pipe (L) $>$ 5 meters, we need recharge the 100g refrigerant per add 1 meter.

That is, the quantity of refrigerant charging = $(L - 5) \times 100(g)$

Refill refrigerant

- When the outdoor valve is shut, fill the refrigerant from the access hole at the gas and liquid sides.
- If the required filling is impossible, open all the gas and liquid valves, then slightly shut the gas valve, run the compressor and fill the refrigerant from the access hole at the gas side. Now adjust the gas valve to control the refrigerant flow, which will be gasified during absorption by the system.
- If there is insufficient refrigerant in the system caused by leaks, refill it after the remaining refrigerant is recollected.

Open all valves

Open all the valves of the outdoor unit.

Heat isolation of the pipes

- Separate isolation should be made for the liquid and gas pipes.
- Materials used for the pipe isolation at the gas side must withstand above 120°C temperature.

Calculation of refrigerant density

Calculation will be made according to the following methods:

(1) Total refrigerant content of each system (kg) = content of 1 outdoor system + refilled refrigerant

Content of 1 outdoor system: Factory filled refrigerant

Refilled refrigerant: Filled content during installation according to the diameter and length of the liquid piping.

(2) Calculation of the minimum room space (m^3).

(3) Calculation of refrigerant density

$$\frac{\text{Total refrigerant content}}{\text{Minimum room space}} \leq \text{Refrigerant density: } 0.3(\text{kg}/\text{m}^3)$$

Preventive measures against excess of critical value

(1) Make ventilation holes

Ventilation holes should be built above and under the door. The area of each hole should not be smaller than 0.15% of the room space. Holes can be made directly in the wall.

(2) Reduce the filling content of refrigerant

- By shortening the distance between the indoor and outdoor units, filling content of refrigerant can be reduced.

- By reducing the capacity of the outdoor unit.

When outdoor unit be made up of several units, the outdoor capacity of each system should reduce. So the refrigerant content of system reduce.

(3) Install ventilation fans.

- Users can install uninterrupted ventilation fans to keep the refrigerant density under the critical value.
- If uninterrupted ventilation is impossible, a combined fanning and alarming device should be installed in its stead (through which immediate ventilation is possible when leak occurs). (See the figure Right)

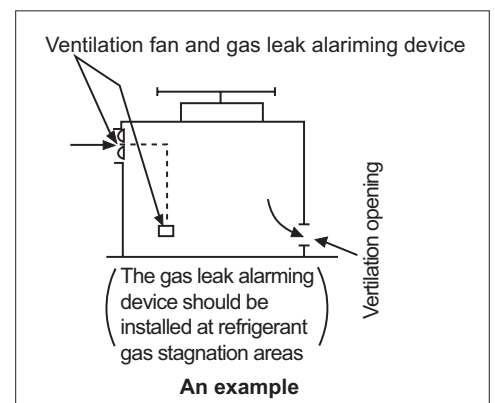

⚠ WARNING

DANGER OF BODILY INJURY OR DEATH

- TURN OFF ELECTRIC POWER AT CIRCUIT BREAKER OR POWER SOURCE BEFORE MAKING ANY ELECTRIC CONNECTIONS.
- GROUND CONNECTIONS MUST BE COMPLETED BEFORE MAKING LINE VOLTAGE CONNECTIONS.

Precautions for Electrical wiring

- Electrical wiring work should be conducted only by authorized personnel.
- Do not connect more than three wires to the terminal block. Always use round type crimped terminal lugs with insulated grip on the ends of the wires.
- Use copper conductor only.

Selection of size of power supply and interconnecting wires.

Select wire sizes and circuit protection from table below. (This table shows 20 m length wires with less than 2% voltage drop.)

Item Model	Phase	Circuit breaker		Power source wire size (minimum) (mm ²)	Earth leakage breaker	
		Switch breaker (A)	Overcurrent protector rated capacity (A)		Switch breaker(A)	Leak current(mA)
AU84NATEAA	3	40	30	6.0	40	30

Wiring connection

- Make wiring to supply power to the outdoor unit, so that the power for the indoor unit is supplied by terminals.
- Connecting cable and power cable are self-provided.

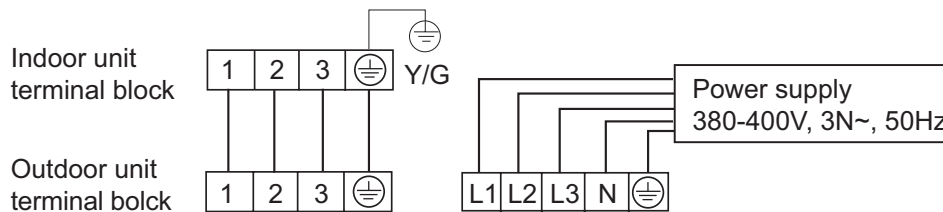

HAIER GROUP

Qingdao Haier Air Conditioner Electric Co., Ltd.

Address: Haier Garden, Qianwangang Road, Economic Development Zone,
Qingdao, Shandong 266500, P.R.China

Web Site: <http://www.haier.com>

Free Manuals Download Website

<http://myh66.com>

<http://usermanuals.us>

<http://www.somanuals.com>

<http://www.4manuals.cc>

<http://www.manual-lib.com>

<http://www.404manual.com>

<http://www.luxmanual.com>

<http://aubethermostatmanual.com>

Golf course search by state

<http://golfingnear.com>

Email search by domain

<http://emailbydomain.com>

Auto manuals search

<http://auto.somanuals.com>

TV manuals search

<http://tv.somanuals.com>