

# SPLIT TYPE ROOM AIR CONDITIONER

# OPERATION MANUAL

AS182ATNDA  
AU182AFNBA  
(HSU-18CW03/R1)  
AS162ATNCA  
AU162AFNAA  
(HSU-16CW03/R1)  
AS072AZBDA  
AU072ABBAA  
(HSU-07HW03/R1)  
AS072AZNDA  
AU072ABNAA  
(HSU-07CW03/R1)

- Please read this operation manual before using the air conditioner.

No. 0010543502

# Contents

Cautions .....	1-2
Parts and functions .....	3-6
Operation .....	7-14
Maintenance .....	15-17
Trouble shooting .....	18

# Cautions

## ***Disposal of the old air conditioner***

Before disposing an old air conditioner that goes out of use, please make sure it's inoperative and safe. Unplug the air conditioner in order to avoid the risk of child entrapment.

It must be noticed that air conditioner system contains refrigerants, which require specialized waste disposal. The valuable materials contained in a air conditioner can be recycled. Contact your local waste disposal center for proper disposal of an old air conditioner and contact your local authority or your dealer if you have any question. Please ensure that the pipework of your air conditioner does not get damaged prior to being picked up by the relevant waste disposal center, and contribute to environmental awareness by insisting on an appropriate, antipollution method of disposal.

## ***Disposal of the packaging of your new air conditioner***

All the packaging materials employed in the package of your new air conditioner may be disposed without any danger to the environment.

The cardboard box may be broken or cut into smaller pieces and given to a waste paper disposal service. The wrapping bag made of polyethylene and the polyethylene foam pads contain no fluorochloric hydrocarbon.

All these valuable materials may be taken to a waste collecting center and used again after adequate recycling.

Consult your local authorities for the name and address of the waste materials collecting centers and waste paper disposal services nearest to your house.

## ***Safety Instructions and Warnings***

Before starting the air conditioner, read the information given in the User's Guide carefully. The User's Guide contains very important observations relating to the assembly, operation and maintenance of the air conditioner.

The manufacturer does not accept responsibility for any damages that may arise due to non-observation of the following instruction.

- Damaged air conditioners are not to be put into operation. In case of doubt, consult your supplier.
- Use of the air conditioner is to be carried out in strict compliance with the relative instructions set forth in the User's Guide.
- Installation shall be done by professional people, don't install unit by yourself.
- For the purpose of safety, the air conditioner must be properly grounded in accordance with specifications.

# Cautions

- Always remember to unplug the air conditioner before opening inlet grill. Never unplug your air conditioner by pulling on the power cord. Always grip plug firmly and pull straight out from the outlet.

- All electrical repairs must be carried out by qualified electricians. Inadequate repairs may result in a major source of danger for the user of the air conditioner.

- Do not damage any parts of the air conditioner that carry refrigerant by piercing or perforating the air conditioner's tubes with sharp or pointed items, crushing or twistings off the surfaces. If the refrigerant spurts out and gets into eyes, it may result in serious eye injuries.

- Do not obstruct or cover the ventilation grille of the air conditioner. Do not put fingers or any other things into the inlet/outlet and swing louver.

- Do not allow children to play with the air conditioner. In no case should children be allowed to sit on the outdoor unit.

## Specifications

- The refrigerating circuit is leak-proof.

The machine is adaptive in following

### 1. Applicable ambient temperature

Cooling	Indoor	Maximum: D.B / 32°C / 23°C Minimum: D.B / 18°C / 14°C
	Outdoor	Maximum: D.B 43°C Minimum: D.B 15°C
Heating	Indoor	Maximum: D.B 27°C Minimum: D.B 20°C
	Outdoor	Maximum: D.B / 24°C / 18°C Minimum: D.B / -7°C / -8°C

2. If the supply cord is damaged, it must be replaced by the manufacturer or its service agent or a similar qualified person. The type of connecting wire is H05RN-F or H07RN-F.

Cooling	Series	07	16,18
	type	3G1.5MM <sup>2</sup>	3G2.0MM <sup>2</sup>
Heating	Series	07	
	type	3G1.5MM <sup>2</sup> +2G0.75MM <sup>2</sup>	

3. If the fuse on PC board is broken please change it with the type of T. 3.15A /250V.
4. The distance between the indoor unit and the floor should be more than 2.0m.
5. The wiring method should be in line with the local wiring standard.
6. After installation, the power plug should be easily reached.
7. The waste battery should be disposed properly.
8. The appliance is not intended for use by young children or infirm persons without supervision.
9. Young children should be supervised to ensure that they do not play with the appliance.
10. The wiring diagram is attached inside the machine.
11. The appliance must be installed on strong enough supporter.

# Parts and Functions

## Indoor Unit

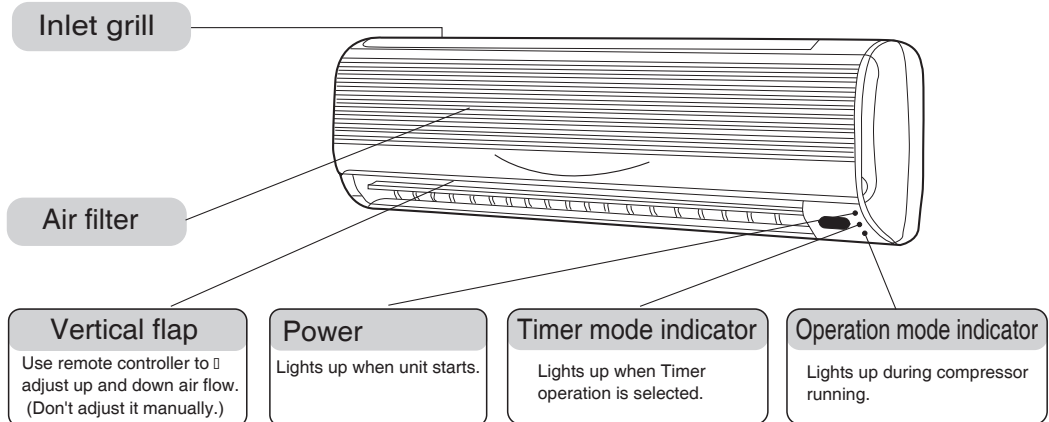

For models: AS072AZBDA  
AU072ABBAA  
(HSU-07HW03/R1)

AS072AZNDA  
AU072ABNAA  
(HSU-07CW03/R1)

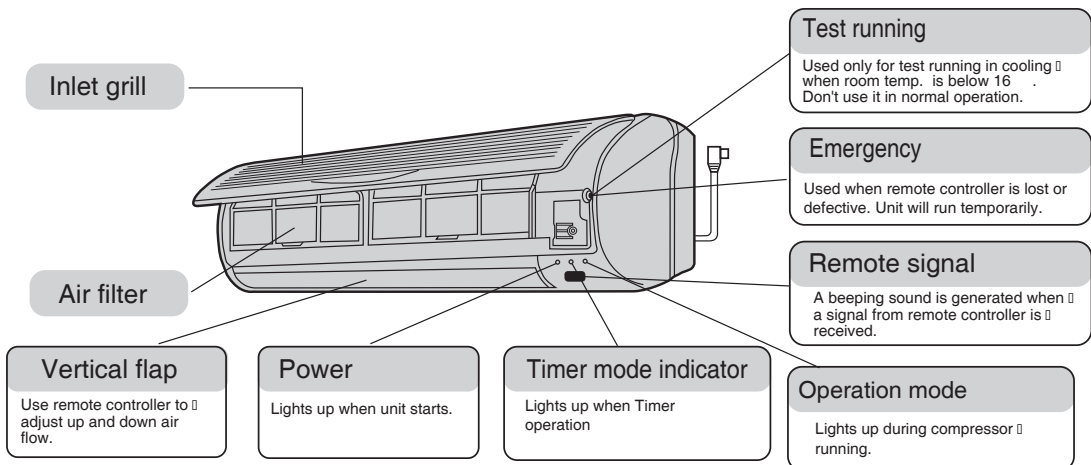

For models: AS182ATNDA  
AU182AFNBA  
(HSU-18CW03/R1)

AS162ATNCA  
AU162AFNAA  
(HSU-16CW03/R1)

# Parts and Functions

## Outdoor Unit

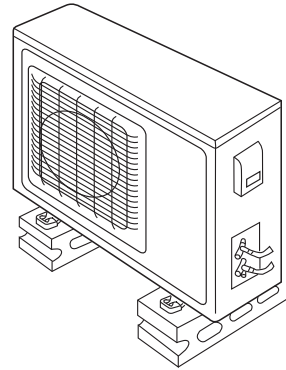
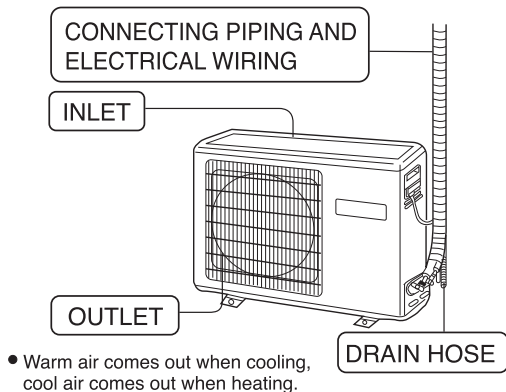

For models: AU072ABBAA AU072ABNAA  
(HSU-07HW03/R1) (HSU-07CW03/R1)

For models: AU182AFNBA AU162AFNAA  
(HSU-18CW03/R1) (HSU-16CW03/R1)

### Power Failure Resume (to be applied for a necessary situation):

After the power failure compensation is set, if power failure suddenly occurs while the air conditioner is working, it will resume the previous working state when the power is again.

**Setting Method:** When the remote controller is on (excluding timer mode and fan mode), press the " SLEEP " button on the remote controller 10 times within 5 seconds, and after the buzzer rings 4 times, the air conditioner will enter the state of power failure resume.

**Cancel Method:** Press the " SLEEP " button on the remote controller 10 times within 5 seconds, and after the buzzer rings 2 timer, the power failure compensation mode will be cancelled.

**Notes:** When a power failure suddenly occurs during the air conditioner is working after the power failure resume is set, if the air conditioner will not be used for a long time, please cut off the power supply to prevent its operation from being resumed after the power is supplied again, or press the " ON/OFF " button after the power comes again.

# Parts and Functions

## Operation

### Buttons and display of the remote

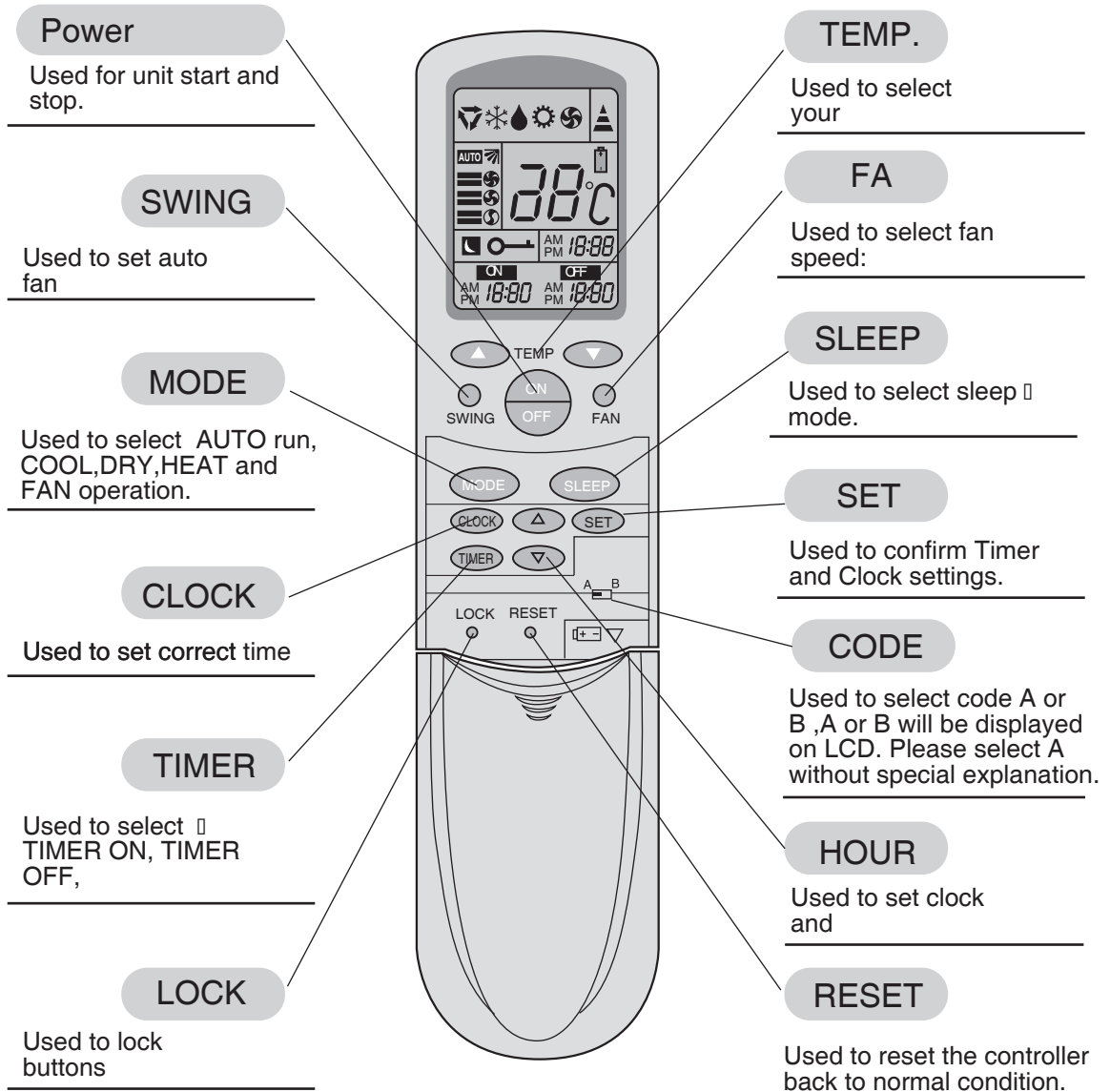

#### Cautions:

On cooling only unit, heating mode is not available.  
After replacing batteries, press ON/OFF, and display □ becomes as follows:  
Operation mode: AUTO, Temp. :No  
Timer mode: No, Fan speed: AUTO

#### Note:

The above information is the □ explanation of the displayed □ information, therefore varies □ with those displayed in actual □ operation.

# Parts and Functions

## Operation

## Buttons and display of the remote

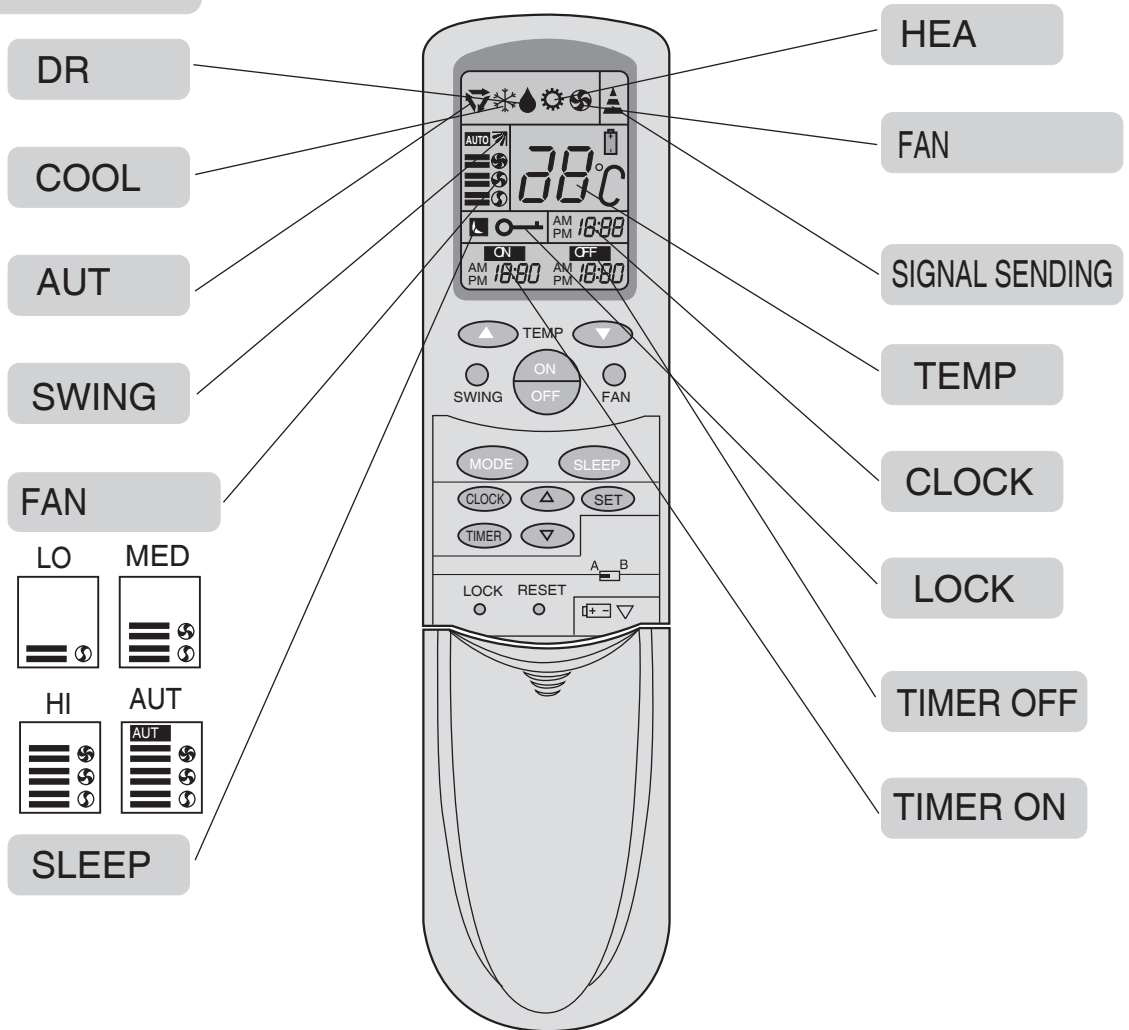

## Clock

When unit is started for the first time and after replacing batteries in remote controller, clock should be adjusted as follows:

Press CLOCK button, "AM" or "PM" flashes.

Press  $\Delta$  or  $\nabla$  to set correct time. Each press will increase or decrease 1 min. If the  $\square$  button is kept depressed, time will change quickly.

After time setting is confirmed, press SET, "AM" and "PM" stop flashing, while clock starts working.

## Hints

After replacing with new batteries, remote controller will conduct self-check, displaying all information on LCD. Then, it will become normal.



# Operation

## Remote controller's operation

- When in use, put the signal transmission head directly to the receiver hole on the indoor unit.
- The distance between the signal transmission head and the receiver hole should be within 7m without any obstacle as well.
- Don't throw the controller, prevent it from being damaged.
- When electronic-started type fluorescent lamp or change-over type fluorescent lamp or wireless telephone is installed in the room, the receiver is apt to be disturbed in receiving the signals, so the distance to the indoor unit should be shorter.

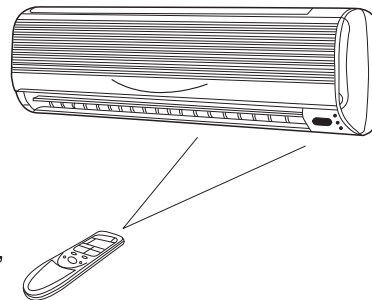

## Loading of the battery

Load the batteries as illustrated.  
2 R-03 batteries, resetting key (cylinder)

### Remove the battery cover :

Slightly press "▼" and push down the cover.

### Load the battery :

Be sure that the loading is in line with the " + " / " - " pole request as illustrated.

### Put on the cover again

### Confirmation indicator :

In disorderation, reload the batteries or load the new batteries after 5mins.

### Note :

Use two new same-typed batteries when loading.  
If the remote controller can't run normally or doesn't work at all, use a sharp pointed item to press the reset key.

**Hint :** Remove the batteries in case unit won't be in usage for a long period.  
If there are any display after taking-out just need to press reset key.

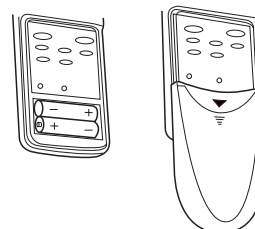
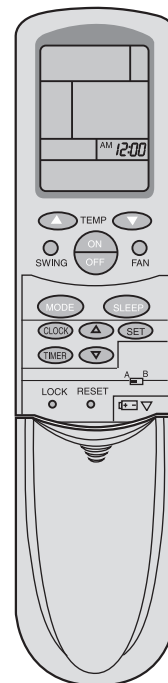

# Operation

## Auto run, Fan operation

Enjoy yourself by just a gentle press.

### (1) Unit start

Press ON/OFF button, unit starts.  
Previous operation status appears on display.  
(Not Timer setting)

### (2) Select operation mode

Press MODE button. For each press, operation

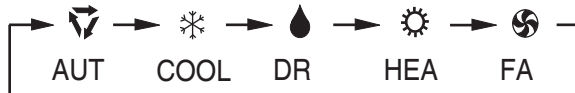

Unit will run in selected mode.  
Stop display at "❄️" AUTO or "🌀" FAN.

### (3) FAN

Press FAN button. For each press, fan speed changes



Unit will run at selected fan speed.  
Note: AUTO is not available in FAN mode.  
Adjust air flow direction if necessary, referring to page10.

### (4) Unit stop

Press ON/OFF button.  
Only time remains on LCD.  
All indicators on indoor unit go out.  
Vertical flap closed automatically.

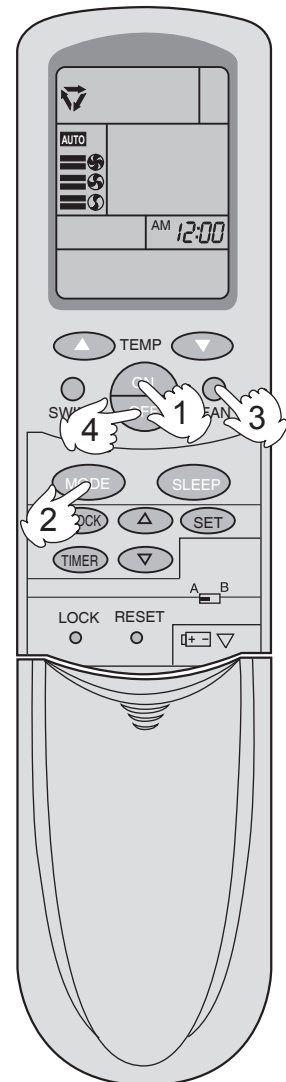

### Hints

Remote controller can memorize settings in each operation mode. To run it next time just select the operation mode and it will start with the previous setting.

# Operation

## COOL, HEAT and DRY operation

- Recommendations:
- Use COOL in summer.
  - Use HEAT in winter.
  - Use DRY in spring, autumn and in damp climate.

### (1) Unit start

Press ON/OFF button, unit starts.  
 Previous operation status appears on display. (Not Timer setting)  
 Power indicator on indoor unit lights up.

### (2) Select operation mode

Press MODE button. For each press, operation

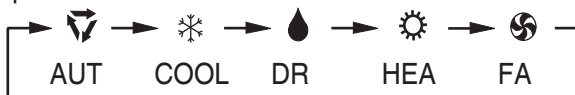

Unit will run in operation mode displayed on LCD.

### (3) Select temp.setting

Press TEMP. button

- △ Every time the button is pressed, temp. setting increases 1°C
- ▽ Every time the button is pressed, temp. setting decreases 1°C

Unit will start running to reach the temp. setting on

### (4) Fan speed selection

Press FAN button. For each press, fan speed changes



Unit runs at the speed displayed on LCD.  
 In HEAT mode, warm air will blow out after a short period of time due to cold-draft prevention function.  
 In DRY mode, when room temp. becomes 2°C higher than temp. setting, unit will run intermittently at LO speed regardless of FAN setting.

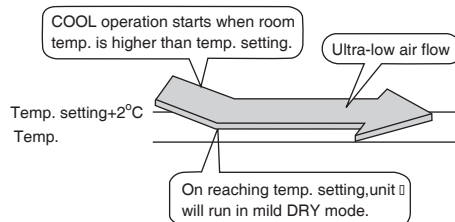
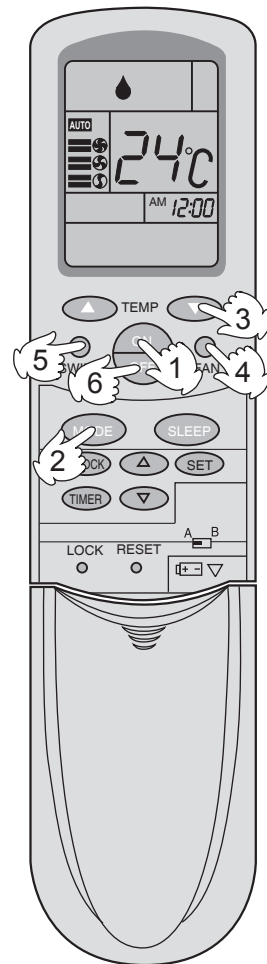

### Hints

Remote controller can memorize each operation status. When starting it next time, just press ON/OFF button and unit will run in previous status.  
 On cooling only unit, heating mode is not available.

# Operation

## (5) Air flow direction adjustment

After operation mode is selected, vertical flap will open automatically according to the mode. Referring to the Fig.

COOL

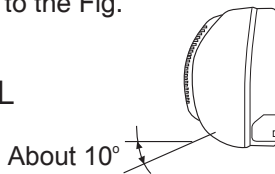

HEAT

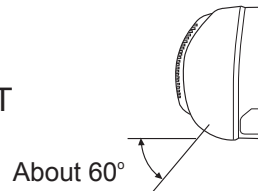

### Up and down (Use remote controller)

Press SWING button, vertical flap will move within the range shown in the Fig. Press SWING button stop it at a fixed position.

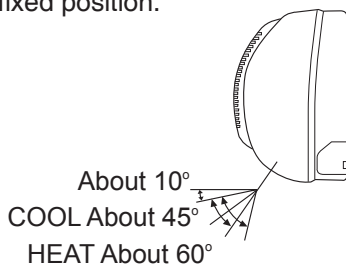

### Left and right air flow adjustment (manual)

Move the horizontal blade by a knob on air conditioner to adjust left and right direction

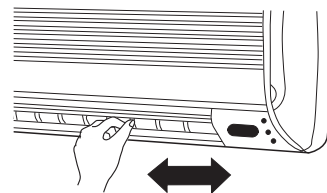

### Cautions:

It is advisable not to keep vertical flap at downward position for a long time in COOL or DRY mode, otherwise, condensate

### Cautions:

When humidity is high, condensate water might occur at air outlet if all horizontal louvers are adjusted to left or right.

## (6) Unit stop

Press ON/OFF button.  
Only time remains on LCD.  
All indicators on indoor unit go out.  
Vertical flap closes automatically.

### Cautions:

Unit won't restart until 3 minutes have elapsed, due to system protection.  
HEAT mode is not available on cooling only unit.

### Hints

As cold air flows downward in COOL mode, adjusting air flow horizontally will be much more helpful for a better air circulation.  
As warm air flows upward in HEAT mode, adjusting air flow downward will be much more helpful for a better air circulation.  
Be careful not to catch a cold when cold air blows downward.  
It is harmful to your health in summer to go frequently in and out of places where temp. difference is above 7°C. Temp. difference of 3-5°C will remove your fatigue.  
More than this, unit's load can be reduced and power consumption cut down as well. So, you'd

# Operation

## TIMER operation

Set Clock correctly before starting Timer operation(referring to page 6)  
You can let unit start or stop automatically at following times: Before you wake up in the

## TIMER ON/OFF

(1)After unit start, select your desire operation mode.  
Operation mode will be displayed on LCD.  
Power indicator on indoor unit lights up.

### (2)TIMER mode selection

Press TIMER button to change TIMER mode.  
Every time the button is pressed, display changes as



Select your desired TIMER mode (TIMER ON or TIMER OFF) ON or OFF will flash.

### (3)Timer setting

Press HOUR  $\Delta$  /  $\nabla$

$\Delta$  Every time the button is pressed, time increases 10 min.  $\square$   
If button is kept depressed, time will change quickly.

$\nabla$  Every time the button is pressed, time decreases 10 min.  
If button is kept depressed, time will change quickly. Time will be shown on LCD. It can be adjusted within 24 hours.

### (4)Confirming your setting

After setting correct time, press SET button to confirm, "ON"  $\square$  or "OFF" stops flashing.

Time displayed: Unit starts or stops at x hour x min. (TIMER ON or TIMER OFF).

Timer mode indicator on indoor unit lights up.

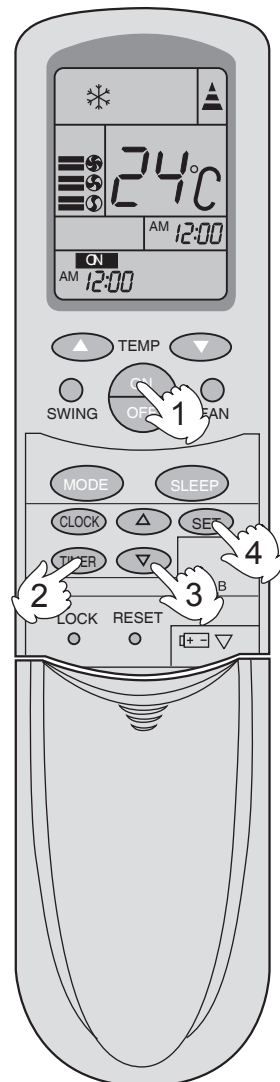

## To cancel TIMER mode

Just press TIMER button several times until TIMER mode

## Hints

After replacing batteries or a power failure happens, Time setting should be reset.  
Remote controller possesses memory function, when use TIMER mode next time, just

# Operation

## TIMER ON-OFF

(1) After unit start, select your desired operation mode  
Operation mode will be displayed on LCD.  
Power indicator on indoor unit lights up.

(2) Press TIMER button to change TIMER mode.  
Every time the button is pressed, display changes as follows:

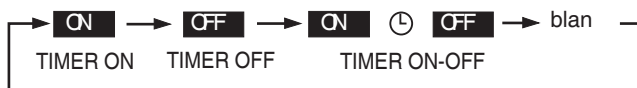

Select TIMER ON-OFF. "ON" will

(3) Time setting for TIMER ON

Press HOUR

△ Every time the button is pressed, time increases 10min.

If button is kept depressed, time will change quickly.

▽ Every time the button is pressed, time decreases 10min.

If button is kept depressed, time will change quickly.

Time will be shown on LCD. □

It can be adjusted within 24 hours.

AM refer's to morning and PM to afternoon.

(4) Time confirming for TIMER ON

After time setting, press TIMER button to confirm.

Time displayed: Unit starts at x hour x min.

(5) Time setting for TIMER OFF

Follow the same procedures in "Time setting for TIMER

(6) Time confirming for TIMER

After time setting, press SET button to confirm, "OFF" stops flashing.

Time displayed: Unit stops at X hour X

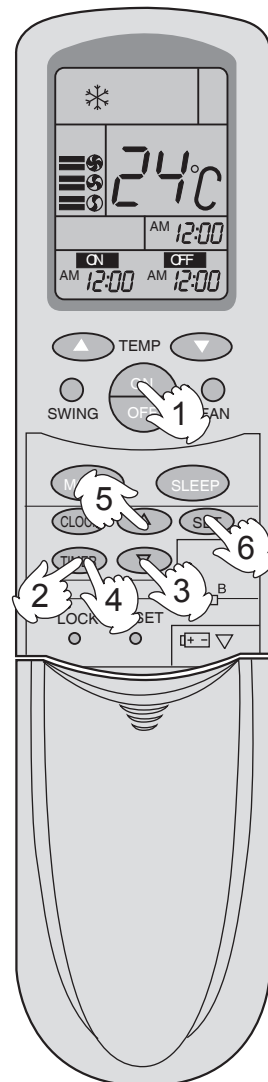

## To cancel TIMER mode

- Just press TIMER button several times until TIMER mode
- According to the Time setting sequence of TIMER ON or TIMER OFF, either Start-Stop or Stop-Start can be achieved.

# Operation

## Emergency operation and test operation

### Emergency

- Carry out this operation only when the remote controller is defective or lost.
- When the emergency operation switch is pressed, a " Pi " sound starts once, which
- means the start of this operation.  
In this operation, it is not possible to change the □ settings of temperature and air flow speed, it is □
- also impossible to do an operation by the timer.

Room □ temperature	Designated □ temperatur	Timer □ mode	Air flow	Operatio n mode
More than 23°C	26°C	——	AUT	COOL
Less than 23°C	23°C	——	AUT	HEA

- ※ If an air conditioner is a model for both cooling and heating.  
Cooling when the room temperature at the start of operation is above 23°C.  
Heating when the room temperature at the start of operation is less 23°C.

### Test operation:

- Use this switch in the test operation when the room □ temperature is less 16°C, do not use it in the normal □ operation.  
Continue to press the test operation switch for more □ than 5 seconds. After you hear the "Pi" sound twice, release your finger from the switch, the cooling □ operation starts with the air flow speed setting "Hi".

### Removal of the restriction of emergency or test

- Press once more the emergency operation switch, or manipulate through the remote controller, a "Pi" sound causes the restriction of emergency or test operation to be □ removed.
- When the remote controller is manipulated for the removal, then the selected operation □ by the remote controller.

# Operation

## Comfortable SLEEP

Before going to bed at night, you can simply press the SLEEP button and unit will bring you a sound sleep in selected mode.

### In COOL mode

One hour after SLEEP mode starts, temp. will become 1°C higher than temp. setting. After running for another 1 hour, temp. rises by 1°C further. Unit will run for 6 hours then stops automatically. Temp. is higher than temp. setting so that room temp. won't be too low for your sleep. (As shown in Fig.1)

### In HEAT mode

One hour after SLEEP mode starts, temp. will become 2°C lower than temp. setting. After running for another 1 hour, temp. decreases by 2°C further. Unit will run for 3 hours at this temp. then increases another 1°C and stops automatically 3 hours later. Temp. is lower than temp. setting so that room temp. won't be too high for your sleep. (As shown in Fig.2)

### Note:

In AUTO mode, unit will run in SLEEP function according to operation mode. In FAN mode, comfortable sleep is not available.

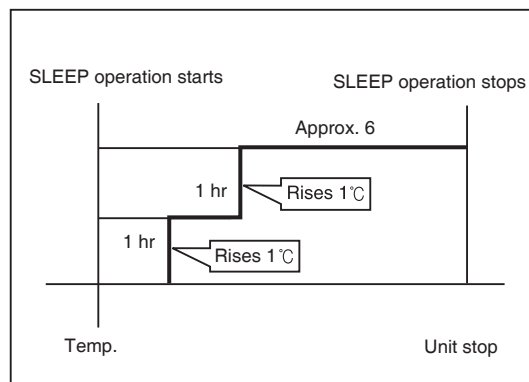
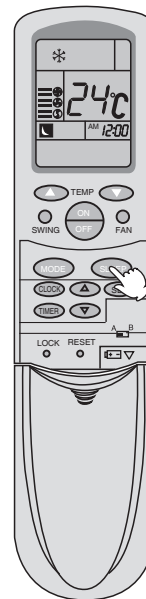

Fig.1

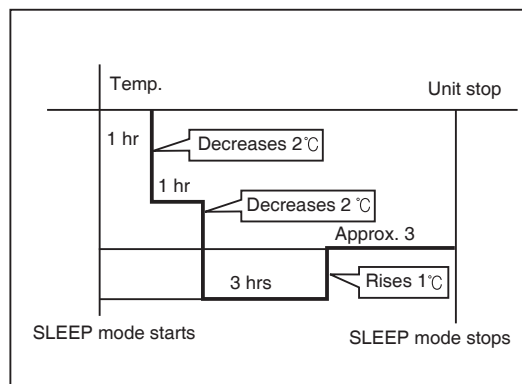

Fig.2



# Maintenance

※ Different models have different appearance.



## Cleaning of unit casing

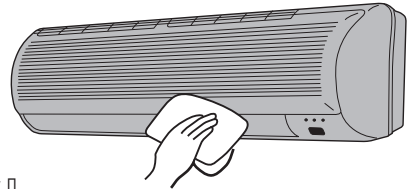

Cut off power supply □ before cleaning wipe unit casing with soft cloth. In case of heavy stain, clean it with neutral detergent. squeeze water in the cloth, wipe off the detergent on unit



## Cleaning of remote controller

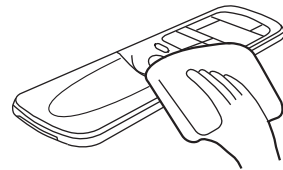

Don't use water to wash unit casing, please use dry cloth. Don't use glass cleaner or cloth soaked with chemicals.



## Cleaning of air filter

### Air Filter Cleaning

**1** Open the inlet grill by pulling it upward.

**2** Remove the filter.

Push up the filter's center tab slightly until it is released from the stopper, and remove the filter downward.

**3** Clean the filter.

Use a vacuum cleaner to remove dust, or wash the filter with water. After washing, dry the filter completely in the shade.

**4** Attach the filter.

Attach the filter correctly so that the "FRONT" indication is facing to the front. Make sure that the filter is completely fixed behind the stopper. If the right and left filters are not attached correctly, that may cause defects.

**5** Close the inlet grill.

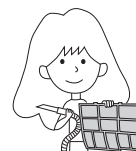
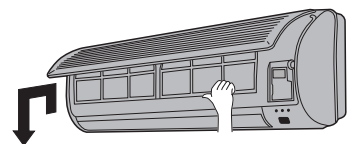

Once every two weeks

# Maintenance

## Replacement of Electrostatic Filter

**1** Detach the Air filters.

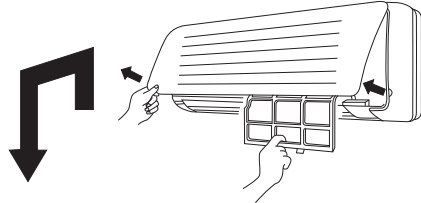

**2** Detach the Electrostatic Filters.

Be careful  
with fins.

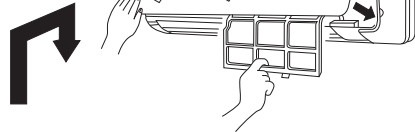

**3** Replace the old filter with  
new one into the frame.

Pull up the hook to the  
designated direction

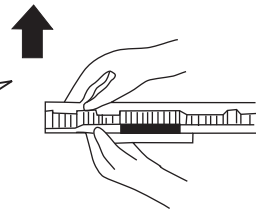

White side should  
be up side.

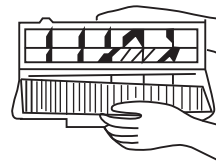

**4** Open the frame of the filter.



**5** Attach the Electrostatic Filters.

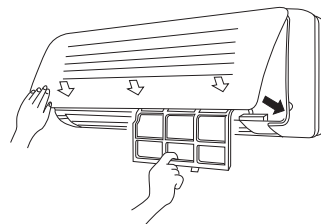

**6** Attach the Air Filters.  
Close the inlet grill.

If Electrostatic Filter can no longer be used, please buy a new one instead.

# Maintenance

## Better use of air conditioner

Proper room

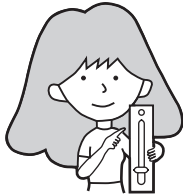

Proper temperature

Cleaning of the air filter.

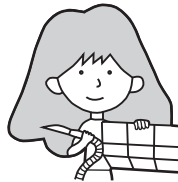

Once every

Closing of doors and windows during operation.



Curtains or blinds for windows

Effective use of the

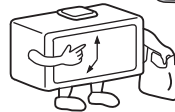
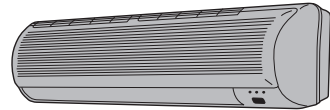

Avoid time-wasteful

Never fail to observe the

Do not sprinkle water over the unit.

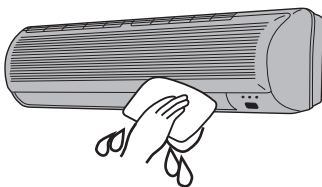

Do not block the inlet or outlet.

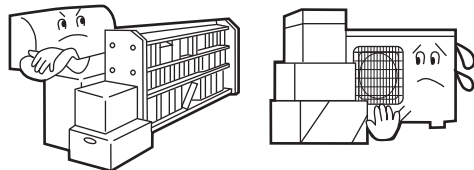

Do not pull power plug.

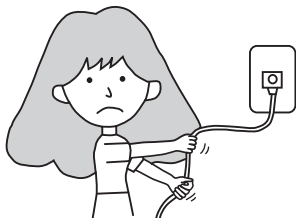



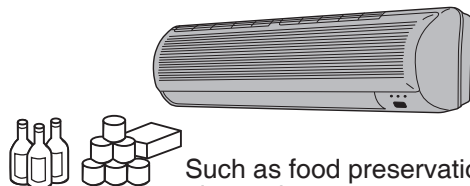

Do not use for other



Such as food preservation, plant cultivation, or animal breeding.

# Trouble Shooting

Before asking for service, check the following first.

	Phenomenon	Cause or check
Normal Performance	The system does not restart immediately. 	<ul style="list-style-type: none"> <li>When unit is stopped, it won't restart immediately until 3 minutes have elapsed to protect the system.</li> <li>When the electric plug is pulled out and reinserted, the protection circuit will work for 3 minutes to protect the air conditioner.</li> </ul>
	Noise is heard. 	<ul style="list-style-type: none"> <li>During unit operation or at stop, a swishing or gurgling noise may be heard. At first 2-3 minutes after unit start, this noise is more noticeable. (This noise is generated by refrigerant flowing in the system.)</li> <li>During unit operation, a cracking noise may be heard. This noise is generated by the casing expanding or shrinking because of temperature changes.</li> <li>Should there be a big noise from air flow in unit operation, air filter may be too dirty.</li> </ul>
	Smells are	<ul style="list-style-type: none"> <li>This is because the system circulates smells from the interior air such as the smell of furniture, cigarettes.</li> </ul>
	Mist or steam are blown 	<ul style="list-style-type: none"> <li>During COOL or DRY operation, indoor unit may blow out mist. This is due to the sudden cooling of indoor air.</li> </ul>
Multiple check	Does not work at all. 	<ul style="list-style-type: none"> <li>Is power plug inserted?</li> <li>Is there a power failure?</li> <li>Is fuse blown out?</li> </ul>
	Poor 	<ul style="list-style-type: none"> <li>Is the air filter dirty? Normally it should be cleaned every 15 days.</li> <li>Are there any obstacles before inlet and outlet?</li> <li>Is temperature set correctly?</li> <li>Are there some doors or windows left open?</li> <li>Is there any direct sunlight through the window during the cooling operation? (Use curtain)</li> <li>Are there too much heat sources or too many people in the room during cooling operation?</li> </ul>

Application temp. range of air conditioner -7°C ~ 43°C.

## Free Manuals Download Website

<http://myh66.com>

<http://usermanuals.us>

<http://www.somanuals.com>

<http://www.4manuals.cc>

<http://www.manual-lib.com>

<http://www.404manual.com>

<http://www.luxmanual.com>

<http://aubethermostatmanual.com>

Golf course search by state

<http://golfingnear.com>

Email search by domain

<http://emailbydomain.com>

Auto manuals search

<http://auto.somanuals.com>

TV manuals search

<http://tv.somanuals.com>