

SPLIT TYPE ROOM AIR CONDITIONER OPERATION MANUAL

AS072AZNBA
AU072ABNCA
(HSU-07CG03/R1)
AS092AMNBA
AU092ABNCA
(HSU-09CG03/R1)
AS122AYNBA
AU122ABNCA
(HSU-12CG03/R1)
AS162ATNBA
AU162AFNBA
(HSU-16CG03/R1)
AS182ASNBA
AU182AFNDA
(HSU-18CG03/R1)
AS222AJNBA
AU222AHNBA
(HSU-22CG03/R1)

- Please read this operation manual before using the air conditioner.

No.0010544375

Contents

| | |
|--------------------------|-------|
| Cautions..... | 1-2 |
| Parts and functions..... | 3-5 |
| Operation..... | 6-13 |
| Maintenance | 14-16 |
| Trouble shooting..... | 17 |

Cautions

Disposal of the old air conditioner

Before disposing an old air conditioner that goes out of use, please make sure it's inoperative and safe. Unplug the air conditioner in order to avoid the risk of child entrapment.

It must be noticed that air conditioner system contains refrigerants, which require specialized waste disposal. The valuable materials contained in a air conditioner can be recycled. Contact your local waste disposal center for proper disposal of an old air conditioner and contact your local authority or your dealer if you have any question. Please ensure that the pipework of your air conditioner does not get damaged prior to being picked up by the relevant waste disposal center, and contribute to environmental awareness by insisting on an appropriate, anti-pollution method of disposal.

Disposal of the packaging of your new air conditioner

All the packaging materials employed in the package of your new air conditioner may be disposed without any danger to the environment.

The cardboard box may be broken or cut into smaller pieces and given to a waste paper disposal service. The wrapping bag made of polyethylene and the polyethylene foam pads contain no fluorochloric hydrocarbon.

All these valuable materials may be taken to a waste collecting center and used again after adequate recycling.

Consult your local authorities for the name and address of the waste materials collecting centers and waste paper disposal services nearest to your house.

Safety Instructions and Warnings

Before starting the air conditioner, read the information given in the User's Guide carefully. The User's Guide contains very important observations relating to the assembly, operation and maintenance of the air conditioner.

The manufacturer does not accept responsibility for any damages that may arise due to non-observation of the following instruction.

- Damaged air conditioners are not to be put into operation. In case of doubt, consult your supplier.
- Use of the air conditioner is to be carried out in strict compliance with the relative instructions set forth in the User's Guide.
- Installation shall be done by professional people, don't install unit by yourself.
- For the purpose of the safety, the air conditioner must be properly grounded in accordance with specifications.
- Always remember to unplug the air conditioner before opening inlet grille. Never unplug your air conditioner by pulling on the power cord. Always grip plug firmly and pull straight out from the outlet.
- All electrical repairs must be carried out by qualified electricians. Inadequate repairs may result in a major source of danger for the user of the air conditioner.
- Do not damage any parts of the air conditioner that carry refrigerant by piercing or perforating the air conditioner's tubes with sharp or pointed items, crushing or twisting any tubes, or scraping the coatings off the surfaces. If the refrigerant spurts out and gets into eyes, it may result in serious eye injuries.

Cautions

- Do not obstruct or cover the ventilation grille of the air conditioner. Do not put fingers or any other things into the inlet/outlet and swing louver.
- Do not allow children to play with the air conditioner. In no case should children be allowed to sit on the outdoor unit.

Specifications

- The refrigerating circuit is leak-proof.

The machine is adaptive in following situation

1. Applicable ambient temperature range:

| | | |
|---------|---------|--|
| Cooling | Indoor | Maximum: D.B/W.B 32°C / 23°C Minimum: D.B/W.B 18°C / 14°C |
| | Outdoor | Maximum: D.B 43°C Minimum: D.B -15°C |
| Heating | Indoor | Maximum: D.B 27°C Minimum: D.B 15°C |
| | Outdoor | Maximum: D.B/W.B 24°C / 18°C Minimum: D.B -20°C |

2. If the supply cord is damaged, it must be replaced by the manufacturer or its service agent or a similar qualified person. The type of connecting wire is H05RN-F or H07RN-F.

| | | | |
|--------|---|---|----------------------|
| Series | 07,09,12 | 16,18 | 22 |
| Type | 3G1.5mm ² +2x0.75mm ² | 3G2.5mm ² +3x0.75mm ² | 4G1.5mm ² |

3. If the fuse on PC board is broken, please change it with the type of T.3.15A/250V.
4. The distance between the indoor unit and the floor should be more than 2m.
5. The wiring method should be in line with the local wiring standard.
6. After installation, the power plug should be easily reached.

7. The waste battery should be disposed properly.
8. The appliance is not intended for use by young children or infirm persons without supervision.
9. Young children should be supervised to ensure that they do not play with the appliance.
10. The wiring diagram is attached inside the machine.
11. The appliance must be installed on strong enough supporter.

Parts and Functions

Indoor Unit

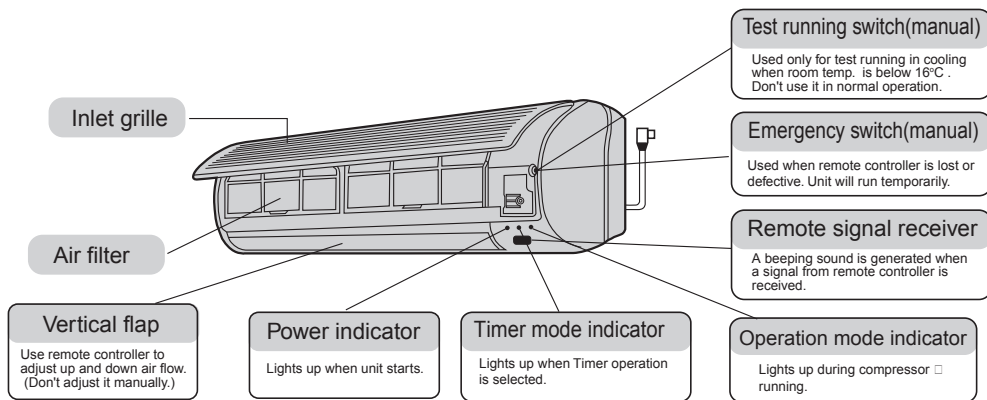

For models: AS072AZNBA (HSU-07CG03/R1) AS092AMNBA (HSU-09CG03/R1) AS122AYNBA (HSU-12CG03/R1)

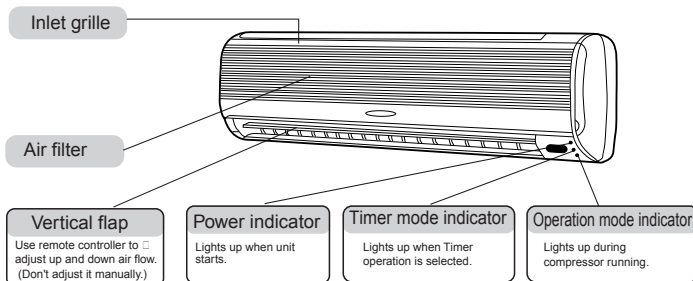

For models: AS162ATNBA (HSU-16CG03/R1) AS182ASNBA (HSU-18CG03/R1)

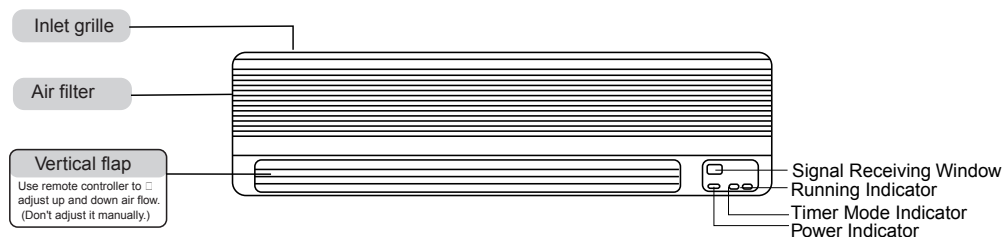

For models: AS222AJNBA (HSU-22CG03/R1)

Parts and Functions

Outdoor Unit

CONNECTING PIPING AND ELECTRICAL WIRING

INLET

OUTLET

For models:

AU072ABNCA
(HSU-07CG03/R1)
AU092ABNCA
(HSU-09CG03/R1)
AU122ABNCA
(HSU-12CG03/R1)

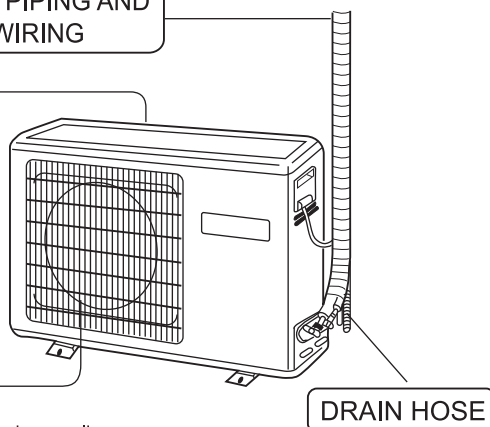

- Warm air comes out when cooling, cool air comes out when heating.

For models:

AU162AFNBA
(HSU-16CG03/R1)
AU182AFNDA
(HSU-18CG03/R1)
AU222AHNBA
(HSU-22CG03/R1)

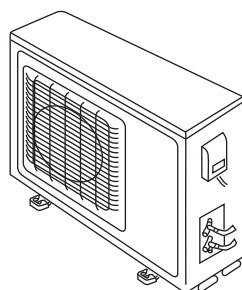

Power Failure Resume (to be applied for a necessary situation):

After the power failure compensation is set, if power failure suddenly occurs while the air conditioner is working, it will resume the previous working state when the power is supplied again.

Setting Method: When the remote controller is on (excluding timer mode and fan mode), press the " SLEEP " button on the remote controller 10 times within 5 seconds, and after the buzzer rings 4 times, the air conditioner will enter the state of power failure resume.

Cancel Method: Press the " SLEEP " button on the remote controller 10 times within 5 seconds, and after the buzzer rings 2 times, the power failure compensation mode will be cancelled.







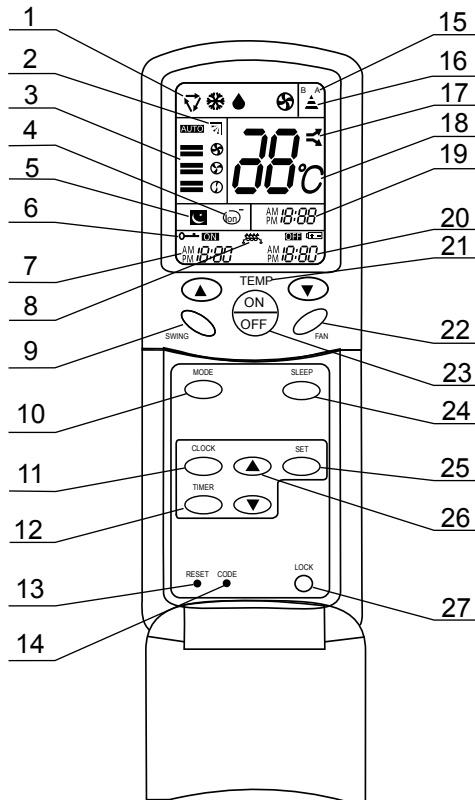

Notes: When a power failure suddenly occurs during the air conditioner is working after the power failure resume is set, if the air conditioner will not be used for a long time, please cut off the power supply to prevent its operation from being resumed after the power is supplied again, or press the " ON/OFF " button after the power comes again.

Parts and Functions

Operation

Buttons and display of the remote controller.



1. Mode display
 AUTO 
 COOL 
 DRY 
 FAN 
2. SWING display 
3. FAN SPEED display 
4. HEALTH display 
5. SLEEP display 
6. LOCK display
7. TIMER ON display
8. AUXILIARY HEAT display
9. SWING
10. MODE
 Used to select AUTO, COOL, DRY, HEAT and FAN
11. CLOCK
 Used to select your desired temp.
12. TIMER
 Used to select TIMER ON, TIMER OFF
13. RESET
 Used to reset the controller back to normal condition
14. CODE
 Used to select code A or B with a press, A or B will be displayed on LCD, please select A without special explanation
15. CODE display
16. SIGNAL SENDING display
17. POWER/SOFT display
18. TEMP. display
19. CLOCK display
20. TIMER OFF display
21. TEMP
 Used to select your desired temperature.
22. FAN
 Used to select fan speed
23. POWER ON/OFF
 Used for unit start or stop
24. SLEEP
 Used to select sleep mode

25. SET
 Used to confirm timer and clock settings
26. HOUR
 Used to set clock and timer settings
27. LOCK
 Used to lock buttons and LCD display

NOTE: (1) The following functions and related displays are not available: HEALTH display, AUXILIARY HEAT display, POWER/SOFT display.

(2) If the Air condition don't have the function, press code B can cause it not available.

(3) Cool only unit do not have functions and displays related with heating.

Clock set

When unit is started for the first time and after replacing batteries in remote controller, clock should be adjusted as follows:

Press CLOCK button, "AM" or "PM" flashes.

Press Δ or ∇ to set correct time. Each press will increase or decrease 1min. If the button is kept depressed, time will change quickly.

After time setting is confirmed, press SET, "AM" and "PM" stop flashing, while clock starts working.

Hints

After replacing with new batteries, remote controller will conduct self-check, displaying all information on LCD. Then, it will become normal.

Operation

Remote controller's operation

- When in use, put the signal transmission head directly to the receiver hole on the indoor unit.
- The distance between the signal transmission head and the receiver hole should be within 7m without any obstacle as well.
- Don't throw the controller, prevent it from being damaged.
- When electronic-started type fluorescent lamp or change-over type fluorescent lamp or wireless telephone is installed in the room, the receiver is apt to be disturbed in receiving the signals so the distance to the indoor unit should be shorter.

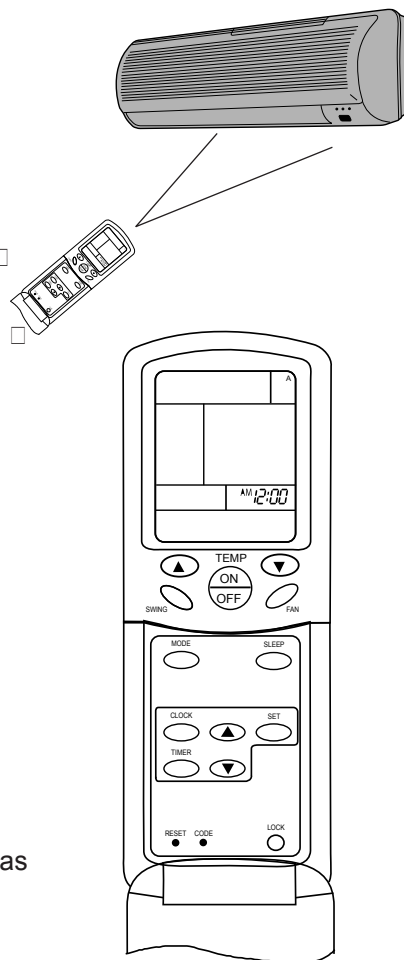

Loading of the battery

Load the batteries as illustrated.

2 R-03 batteries, resetting key (cylinder)

Remove the battery cover :

Slightly press "▼" and push down the cover.

Load the battery :

Be sure that the loading is in line with the " + " / " - " pole request as illustrated.

Put on the cover again

Confirmation indicator :

In disorderation, reload the batteries or load the new batteries after 6 mins.

Note :

Use two new same-typed batteries when loading.
If the remote controller can't run normally or doesn't work at all, use a sharp pointed item to press the reset key.

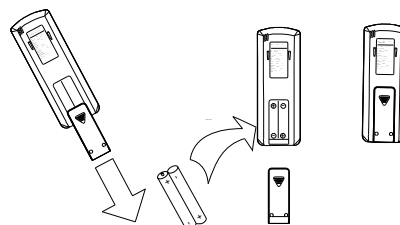

Hint :

Remove the batteries in case unit won't be in usage for a long period.
If there are any display after taking-out just need to press reset key.

Operation

Auto run, Fan operation

Enjoy yourself by just a gentle press.

(1) Unit start

Press ON/OFF button, unit starts.
Previous operation status appears on display.
(Not Timer setting)
Power indicator on indoor unit lights up.

(2) Select operation mode

Press MODE button. For each press, operation mode changes as follows:

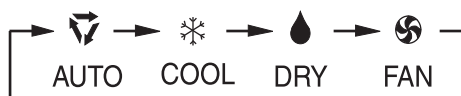

Unit will run in selected mode.
Stop display at "AUTO" or "FAN".

(3) FAN

Press FAN button. For each press, fan speed changes as follows:

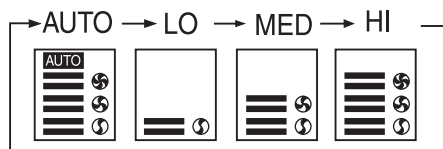

Unit will run at selected fan speed.
Note: AUTO is not available in FAN mode.
Adjust air flow direction if necessary, referring to page 9.

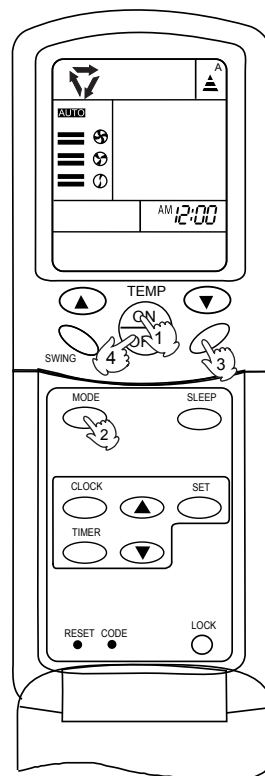

(4) Unit stop

Press ON/OFF button.
Only time remains on LCD.
All indicators on indoor unit go out.
Vertical flap closed automatically.

Hints

Remote controller can memorize settings in each operation mode. To run it next time just select the operation mode and it will start with the previous setting.

No reselecting is needed. (TIMER ON/OFF needs reselecting)

Cautions:

On cooling only unit, heating mode is not available,
After replacing batteries, press ON/OFF, and display becomes as follows:

Operation mode: AUTO, Temp. No

Timer mode: No, Fan speed : AUTO

Note:

The above information is the explanation of the displayed information therefore varies with those displayed in actual operation.

Operation

COOL and DRY operation

Recommendations:

- Use COOL in summer.
- Use DRY in spring, autumn and in damp climate.

(1) Unit start

Press ON/OFF button, unit starts.

Previous operation status appears on display. (Not Timer setting)

Power indicator on indoor unit lights up.

(2) Select operation mode

Press MODE button. For each press, operation mode changes as follows:

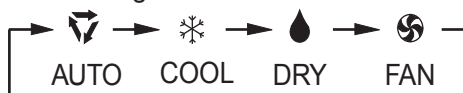

Unit will run in operation mode displayed on LCD.

Stop display at your desired mode.

(3) Select temp. setting

Press TEMP. button.

△ Every time the button is pressed, temp. setting increases 1°C

▽ Every time the button is pressed, temp. setting decreases 1°C

Unit will start running to reach the temp. setting on LCD.

(4) Fan speed selection

Press FAN button. For each press, fan speed changes as follows:

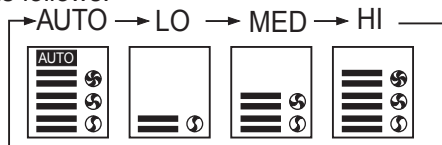

Unit runs at the speed displayed on LCD.

In DRY mode, when room temp. becomes 2°C higher than temp. setting, unit will run intermittently at LO speed regardless of FAN setting.

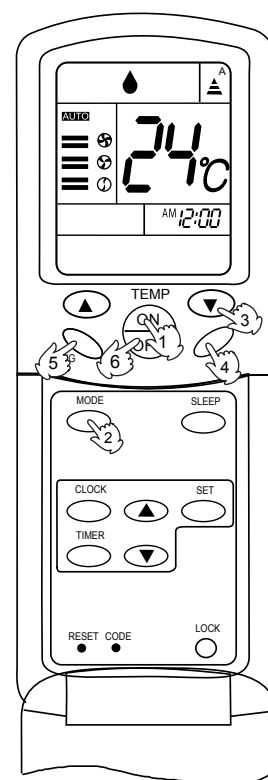

COOL operation starts when room temp. is higher than temp. setting.

Ultra-low air flow

Temp. setting+2°C
Temp. setting

On reaching temp. setting, unit will run in mild DRY mode.

Hints

Remote controller can memorize each operation status. When starting it next time, just press ON/OFF button and unit will run in previous status.

Operation

(5) Air flow direction adjustment

After operation mode is selected, vertical flap will open automatically according to the mode.

Referring to the Fig.

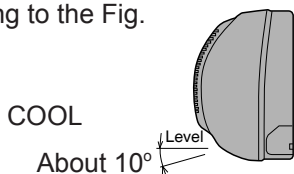

Up and down (Use remote controller)

Press SWING button, vertical flap will move within the range shown in the Fig. Press SWING button stop it at a fixed position.

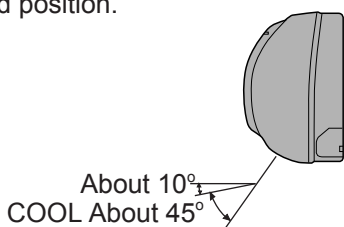

Left and right air flow adjustment (manual)

Move the horizontal blade by a knob on air conditioner to adjust left and right direction referring to Fig.

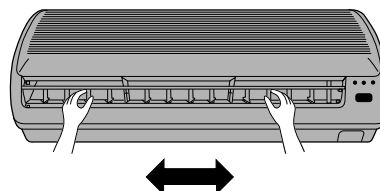

Cautions:

It is advisable not to keep vertical flap at downward position for a long time in COOL or DRY mode, otherwise, condensate water might occur.

Cautions:

When humidity is high, condensate water might occur at air outlet if all horizontal louvers are adjusted to left or right.

(6) Unit stop

Press ON/OFF button.

Only time remains on LCD.

All indicators on indoor unit go out.

Vertical flap closes automatically.

Cautions:

Unit won't restart until 3 minutes have elapsed, due to system protection.

Hints

As cold air flows downward in COOL mode, adjusting air flow horizontally will be much more helpful for a better air circulation.

Be careful not to catch a cold when cold air blows downward.

It is harmful to your health in summer to go frequently in and out of places where temp. difference is above 7°C. Temp. difference of 3-5°C will remove your fatigue.

More than this, unit's load can be reduced and power consumption cut down as well. So, you'd better set a temp. diff of 3-5°C between indoor and outdoor temp. in COOL mode.

Operation

TIMER operation

Set Clock correctly before starting Timer operation(referring to page 5)

You can let unit start or stop automatically at following times: Before you wake up in the morning, or get back from outside or after you fall asleep at night.

TIMER ON/OFF

(1)After unit start, select your desired operation mode.

Operation mode will be displayed on LCD.

Power indicator on indoor unit lights up.

(2)TIMER mode selection

Press TIMER button to change TIMER mode.

Every time the button is pressed, display changes as follows:



Select your desired TIMER mode (TIMER ON or TIMER OFF) ON or OFF will flash.

(3)Timer setting

Press HOUR Δ / ∇ button.

Δ Every time the button is pressed, time increases 10 min.

If button is kept depressed, time will change quickly.

∇ Every time the button is pressed, time decreases 10 min.

If button is kept depressed, time will change quickly. Time will be shown on LCD. It can be adjusted within 24 hours.

(4)Confirming your setting

After setting correct time, press SET button to confirm, "ON" or "OFF" stops flashing

Time displayed: Unit starts or stops at x hour x min. (TIMER ON or TIMER OFF).

Timer mode indicator on indoor unit lights up.

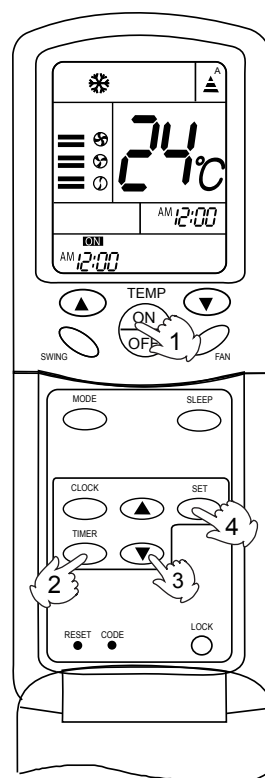

To cancel TIMER mode

Just press TIMER button several times until TIMER mode disappears.

Hints

After replacing batteries or a power failure happens, Time setting should be reset.

Remote controller possesses memory function, when use TIMER mode next time, just press SET button after mode selecting if timer setting is the same as previous one.

Operation

TIMER ON-OFF

(1) After unit start, select your desired operation mode
Operation mode will be displayed on LCD.
Power indicator on indoor unit lights up.

(2) Press TIMER button to change TIMER mode.
Every time the button is pressed, display changes as follows:



Select TIMER ON-OFF. "ON" will flash.

(3) Time setting for TIMER ON

Press HOUR button.

△ Every time the button is pressed, time increases 10min.

If button is kept depressed, time will change quickly.

▽ Every time the button is pressed, time decreases 10min.

If button is kept depressed, time will change quickly.

Time will be shown on LCD. □

It can be adjusted within 24 hours.

AM refer's to morning and PM to afternoon.

(4) Time confirming for TIMER ON

After time setting, press TIMER button to confirm.

"ON" stops blinking, While "OFF" starts blinking.

Time displayed: Unit starts at x hour x min.

(5) Time setting for TIMER OFF

After time setting, press SET button to confirm, "OFF" stops flashing.

Time displayed: Unit stops at X hour X min.

(6) Time confirming for TIMER OFF

Follow the same procedures in "Time setting for TIMER ON".

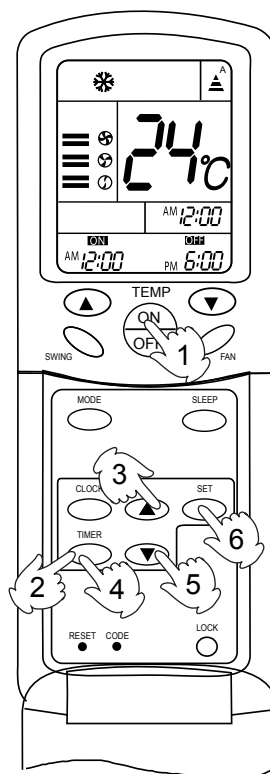

To cancel TIMER mode

■ Just press TIMER button several times until TIMER mode disappears.

Operation

Comfortable SLEEP

Before going to bed at night, you can simply press the SLEEP button and unit will bring you a sound sleep in selected mode.

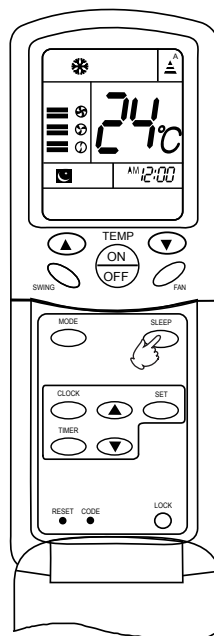

In COOL ,DRY mode

One hour after SLEEP mode starts, temp. will become 1°C higher than temp. setting. After running for another 1 hour, temp. rises by 1°C further. Unit will run for 6 hours then stops automatically. Temp. is higher than temp. setting so that room temp. won't be too low for your sleep. (As shown in Fig.1)

Note:

In AUTO mode, unit will run in SLEEP function according to operation mode. In FAN mode, comfortable sleep is not available.

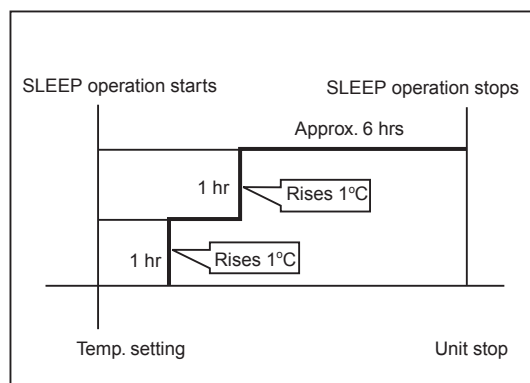

Fig.1

Operation

Emergency operation and test operation

Emergency Operation:

- Carry out this operation only when the remote controller is defective or lost.
- When the emergency operation switch is pressed, a " Pi " sound starts once, which means the start of this operation.
- In this operation, it is not possible to change the settings of temperature and air flow speed, it is also impossible to do an operation by the timer.
- Follow the requirements below.

| Room <input type="checkbox"/> temperature | Designated <input type="checkbox"/> temperature | Timer <input type="checkbox"/> mode | Air flow speed | Operation mode |
|---|---|-------------------------------------|----------------|----------------|
| More than 23°C | 26°C | CONTINUOUS | AUTO | COOL |

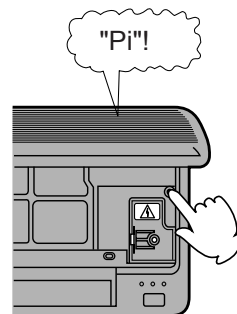

- ※ If an air conditioner is a model cooling .
Cooling when the room temperature at the start of operation is above 23°C.

Test operation:

- Use this switch in the test operation when the room temperature is less 16°C, do not use it in the normal operation.
Continue to press the test operation switch for more than 5 seconds. After you hear the "Pi" sound twice, release your finger from the switch, the cooling operation starts with the air flow speed setting "Hi".

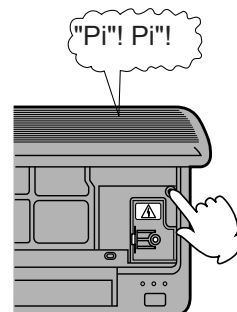

Removal of the restriction of emergency or test operation:

- Press once more the emergency operation switch, or manipulate through the remote controller, a "Pi" sound causes the restriction of emergency or test operation to be removed.
- When the remote controller is manipulated for the removal, then the selected operation by the remote controller.

Maintenance

※Different models have different appearance.



Cleaning of unit casing

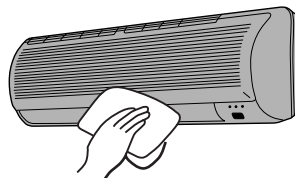

Cut off power supply before cleaning wipe unit casing with soft cloth. In case of heavy stain, clean it with neutral detergent. squeeze water in the cloth, wipe off the detergent on unit casing completely.



Cleaning of remote controller



Cleaning of air filter

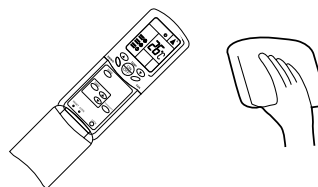

Don't use water to wash unit casing, please use dry cloth. Don't use glass cleaner or cloth soaked with chemicals.

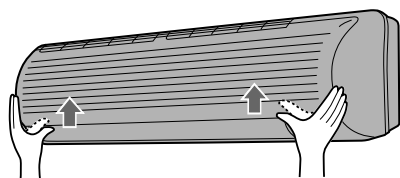

1. Open inlet grille by pulling it upward.

3. Clean the filter
Use a vacuum
cleaner to remove
dust, or wash the
filter with water.
After washing,
dry the filter
completely in the shade.

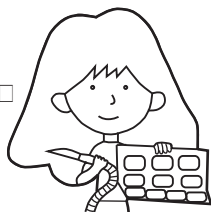

5. Close the inlet grille.

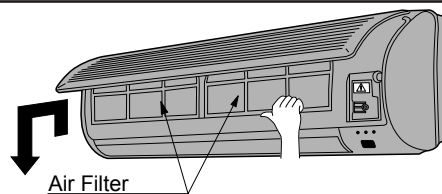

2. Remove air filters

Push up the filter's center tab slightly until it is caesura of the stopper. Remove it by pulling down.

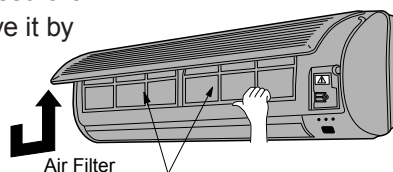

4. Attach the filters

Attach filter behind the stopper so that the " Front " indication is facing to the front. Make sure that it is completely behind the stopper, otherwise problems might occur.

Maintenance

Replacement of Electrostatic Filter

1 Detach the Air filters.

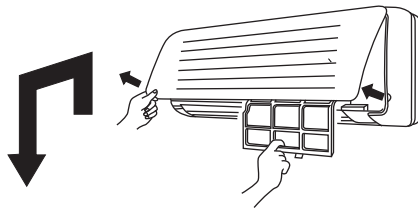

2 Detach the Electrostatic Filters.

Be careful with fins.

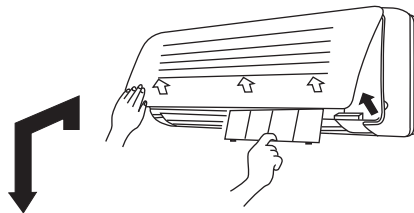

3 Replace the old filter with new one into the frame.

Pull up the hook to the designated direction

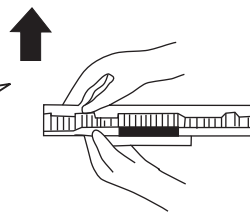

White side should be up side.

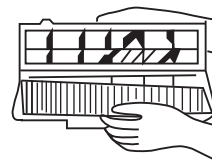

4 Open the frame of the filter.

5 Attach the Electrostatic Filters.



6 Attach the Air Filters.
Close the inlet grille.

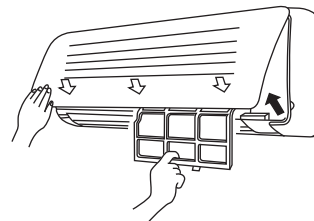



Some of the models may not have the frame of the filter.

If Electrostatic Filter can no longer be used, please buy a new one instead.

Maintenance

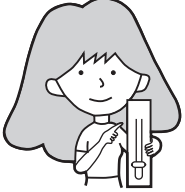
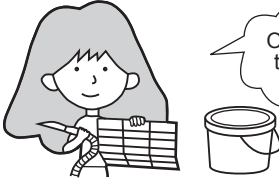
Better use of air conditioner

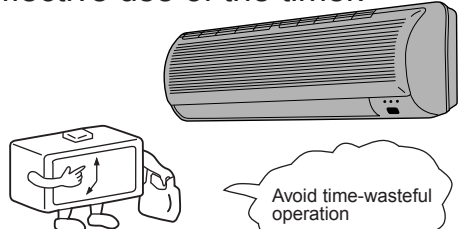

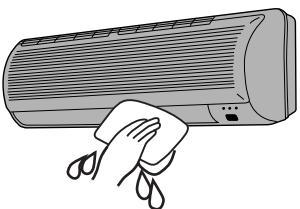
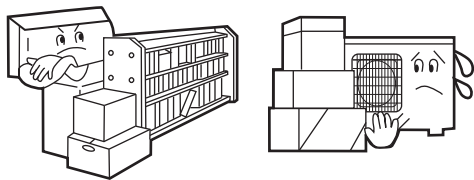
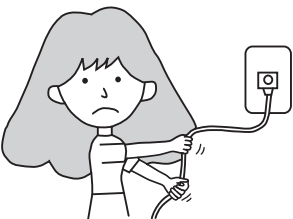
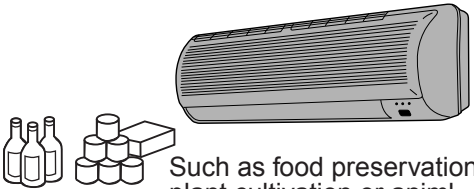

| | |
|--|--|
| <p>Proper room temperature.</p>  <p>Proper temperature</p> | <p>Cleaning of the air filter.</p>  <p>Once every two weeks</p> |
| <p>Closing of doors and windows <input type="checkbox"/> during operation.</p>  <p>Curtains or blinds for windows</p> | <p>Effective use of the timer.</p>  <p>Avoid time-wasteful operation</p> |

Never fail to observe the followings

| | |
|--|---|
| <p>Do not sprinkle water over the unit..</p>  | <p>Do not block the inlet or outlet.</p>  |
| <p>Do not pull power plug.</p>  | <p>Do not use for other purposes.</p>  <p>Such as food preservation, plant cultivation, or animal breeding.</p> |

Trouble shooting

Before asking for service, check the following first.

| | Phenomenon | Cause or check points |
|---|---|---|
| Normal performance inspection | <p>The system does not restart immediately.</p>  | <ul style="list-style-type: none"> • When unit is stopped, it won't restart immediately until 3 minutes have elapsed to protect the system. • When the electric plug is pulled out and reinserted, the protection circuit will work for 3 minutes to protect the air conditioner. |
| | <p>Noise is heard :</p>  | <ul style="list-style-type: none"> • During unit operation or at stop, a swishing or gurgling noise may be heard. At first 2-3 minutes after unit start, this noise is more noticeable. (This noise is generated by <input type="checkbox"/> refrigerant flowing in the system.) • During unit operation, a cracking noise may <input type="checkbox"/> be heard. This noise is generated by the casing expanding or shrinking because of temperature changes. • Should there be a big noise from air flow in unit operation, air filter may be too dirty. |
| | <p>Smells are generated.</p> | <ul style="list-style-type: none"> • This is because the system circulates smells <input type="checkbox"/> from the interior air such as the smell of <input type="checkbox"/> furniture, cigarettes. |
| | <p>Mist or steam are blown out.</p>  | <ul style="list-style-type: none"> • During COOL or DRY operation, indoor unit may blow out mist. This is due to the sudden cooling of indoor air. |
| Multiple <input type="checkbox"/> check | <p>Does not work at all.</p>  | <ul style="list-style-type: none"> • Is power plug inserted? • Is there a power failure? • Is fuse blown out? |
| | <p>Poor cooling</p>  | <ul style="list-style-type: none"> • Is the air filter dirty? Normally it should be cleaned every 15 days. • Are there any obstacles before inlet and outlet? • Is temperature set correctly? • Are there some doors or windows left open? • Is there any direct sunlight through the <input type="checkbox"/> window during the cooling operation?(Use curtain) • Are there too much heat sources or too many people in the room during cooling operation? |

Application temp. range of air conditioner $-7^{\circ}\text{C}\sim 43^{\circ}\text{C}$.

Free Manuals Download Website

<http://myh66.com>

<http://usermanuals.us>

<http://www.somanuals.com>

<http://www.4manuals.cc>

<http://www.manual-lib.com>

<http://www.404manual.com>

<http://www.luxmanual.com>

<http://aubethermostatmanual.com>

Golf course search by state

<http://golfingnear.com>

Email search by domain

<http://emailbydomain.com>

Auto manuals search

<http://auto.somanuals.com>

TV manuals search

<http://tv.somanuals.com>