

INSTALLATION MANUAL

Haier

ROOM AIR CONDITIONER
WALL MOUNTED TYPE

HSU-09HEA03/R2-I

HSU-12HEA03/R2-I

HSU-18HEA03/R2-I

Read this manual before installation
Explain sufficiently the operating means to the user according to this manual.

NO.0010523234

Necessary Tools for Installation

- | | | | |
|---------------------------|---------------------------------|--|-----------|
| 1.Driver | 5.Torque wrench(17mm,22mm,26mm) | 9.Nipper | 12.Reamer |
| 2.Hacksaw | 6.Pipe cutter | 10.Gas leakage detector or soap-and-water solution | |
| 3.Hole core drill | 7.Flaring tool | 11.Measuring tape | |
| 4.Spanner(17,19 and 26mm) | 8.Knife | | |

Drawing for the installation of indoor and outdoor units

Accessory parts

No.	Accessory parts	Number of articles
①	Remote controller	1
②	R-03 dry battery	2
③	Mounting plate	1
④	Drain hose	1
⑤	φ4X50 Steel nail, cement	6
⑥	φ4X25 Screw Plastic cap	4
⑦	Cover	1
⑧	Cushion	4
⑨	Pipe supporting plate	1
⑩	Drain-elbow	1

Optional parts for piping

Mark	Parts name
(A)	Non-adhesive tape
(B)	Adhesive tape
(C)	Saddle(L.S) with screws
(D)	Connecting electric cable for indoor and outdoor
(E)	Drain hose
(F)	Heating insulating material
(G)	Piping hole cover

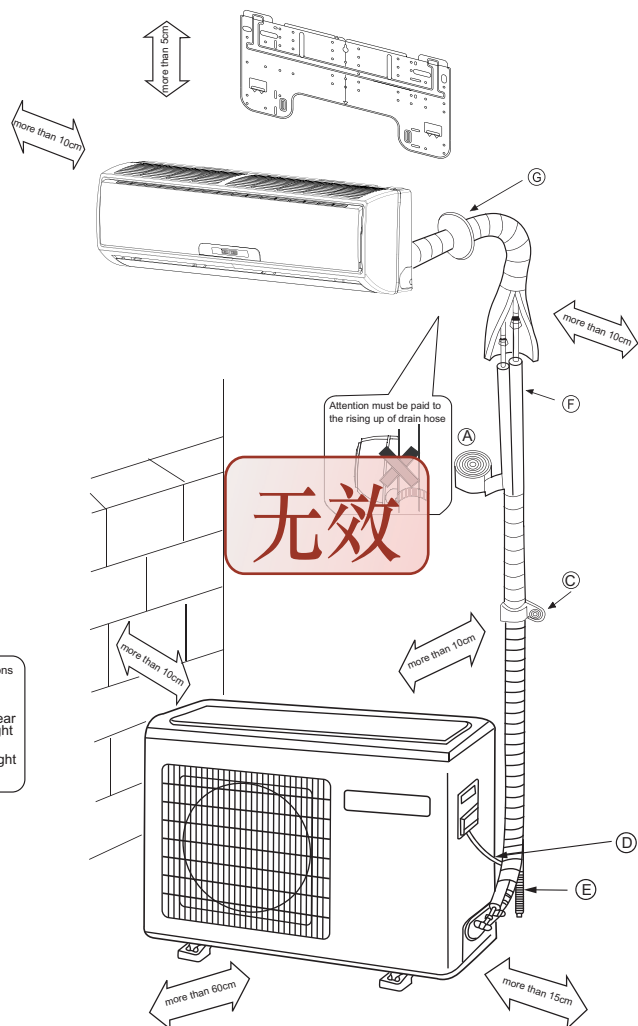
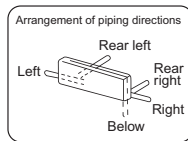

- ※ The marks from (A) to (G) in the figure are the parts numbers.
- ※ The distance between the indoor unit and the floor should be more than 2m.

No.00105

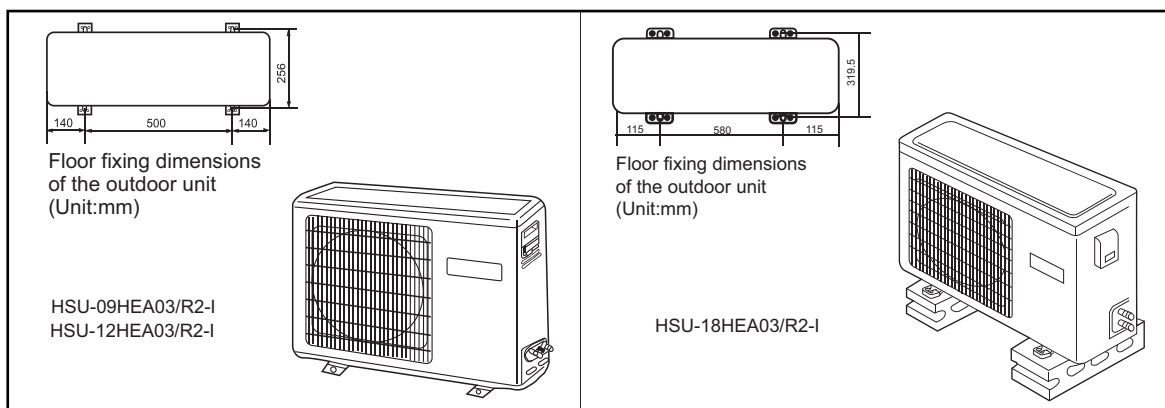

Fixing of outdoor unit

- Fix the unit to concrete or block with bolts ($\phi 10\text{mm}$) and nuts firmly and horizontally.
- When fitting the unit to wall surface, roof or rooftop, fix a supporter surely with nails or wires in consideration of earthquake and strong wind.
- If vibration may affect the house, fix the unit by attaching a vibration-proof mat.

Indoor Unit

Selection of Installation Place

Outdoor Unit

- Place, robust not causing vibration, where the body can be supported sufficiently.
- Place, not affected by heat or steam generated in the vicinity, where inlet and outlet of the unit are not disturbed.
- Place, possible to drain easily, where piping can be connected with the outdoor unit.
- Place, where cold air can be spread in a room entirely.
- Place, nearby a power receptacle, with enough space around (Refer to drawings).
- Place where the distance of more than 1m from televisions, radios, wireless apparatuses and fluorescent lamps can be left.
- In the case of fixing the remote controller on a wall, place where the indoor unit can receive signals when the fluorescent lamps in the room are lightened.

- Place, which is less affected by rain or direct sunlight and is sufficiently ventilated.
- Place, possible to bear the unit, where vibration and noise are not increased.
- Place, where discharged wind and noise do not cause a nuisance to the neighbors.
- Place, where a distance marked \leftrightarrow is available as illustrated in the above figure.

无效

Power Source

- Before inserting power plug into receptacle, check the voltage without fail. The power source is the same as the corresponding name plate.
- Install an exclusive branch circuit of the power.
- A receptacle shall be set up in a distance where the power cable can be reached. Do not extend the cable by cutting it.

Selection of pipe

- To this unit, both liquid and gas pipes shall be insulated as they become low temperature in operation.
- Use optional parts for piping set or pipes covered with equivalent insulation material.

	For 09K .12K	For 18K
Liquid pipe (ϕ)	6.35mm(1/4")	6.35mm(1/4")
Gas pipe (ϕ)	9.52mm(3/8")	12.7mm(1/2")

Indoor unit

1. Fitting of the Mounting Plate and Positioning of the wall Hole

When the mounting plate is first fixed

1. Carry out, based on the neighboring pillars or lintels, a proper leveling for the plate to be fixed against the wall, then temporarily fasten the plate with one steel nail.
2. Make sure once more the proper level of the plate, by hanging a thread with a weight from the central top of the plate, then fasten securely the plate with the attachment steel nail.
3. Find the wall hole location A using a measuring tape

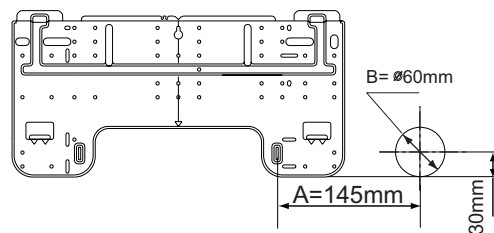

When the mounting plate is fixed side bar and lintel

- Fix to side bar and lintel a mounting bar, which is separately sold, and then fasten the plate to the fixed mounting bar.
- Refer to the previous article, " **When the mounting plate is first fixed** ", for the position of wall hole.

2. Making a Hole on the Wall and Fitting the Piping Hole Cover

- Make a hole of 60 mm in diameter, slightly descending to outside the wall.
- Install piping hole cover and seal it off with putty after installation

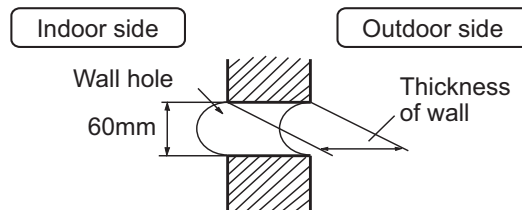

(Section of wall hole) © Piping hole pipe

3. Installation of the Indoor Unit

Drawing of pipe

[Rear piping]

- Draw pipes and the drain hose, then fasten them with the adhesive tape

[Left • Left-rear piping]

- In case of left side piping, cut away, with a nipper, the lid for left piping.
- In case of left-rear piping, bend the pipes according to the piping direction to the mark of hole for left-rear piping which is marked on heat insulation materials.

Indoor unit

1. Insert the drain hose into the dent of heat insulation materials of indoor unit.
2. Insert the indoor/outdoor electric cable from backside of indoor unit, and pull it out on the front side, then connect them.
3. Coat the flaring seal face with refrigerant oil and connect pipes.
Cover the connection part with heat insulation materials closely, and make sure fixing with adhesive tape

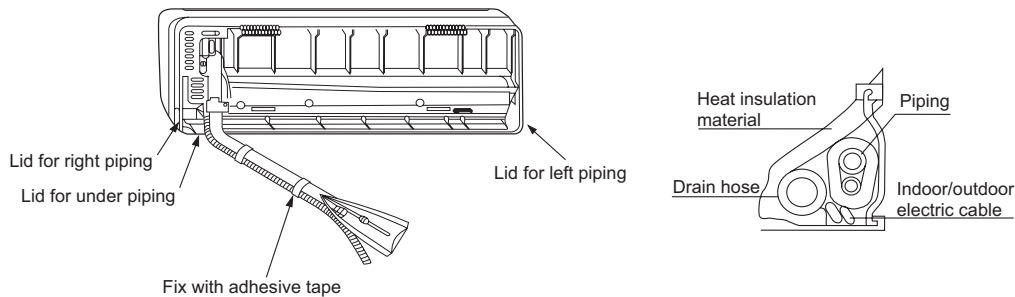

- Indoor/outdoor electric cable and drain hose must be bound with refrigerant piping by protecting tape.

[Other direction piping]

- Cut away, with a nipper, the lid for piping according to the piping direction and then bend the pipe according to the position of wall hole. When bending, be careful not to crash pipes.
- Connect beforehand the indoor/outdoor electric cable, and then pull out the connected to the heat insulation of connecting part specially.

Fixing the indoor unit body

- Hang surely the unit body onto the upper notches of the mounting plate. Move the body from side to side to verify its secure fixing.
- In order to fix the body onto the mounting plate, hold up the body aslant from the underside and then put it down perpendicularly.

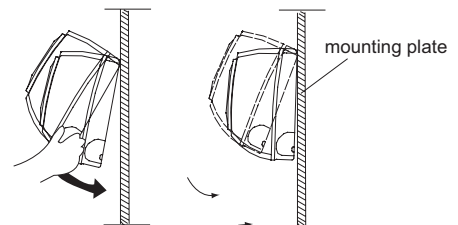

Unloading of indoor unit body

- When you unload the indoor unit, please use your hand to arise the body to leave agraffe, then lift the bottom of the body outward slightly and lift the unit aslant until it leaves the mounting plate.

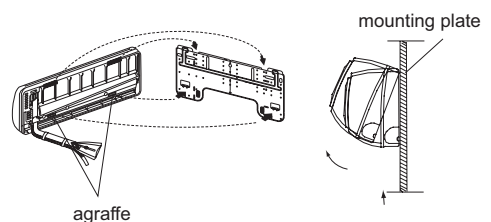

Easily-demount cleaning of indoor unit

Inlet grille can be taken down

Open the inlet grille, press the button of unlock in the left, then push it out of the socket and take out the inlet grille.

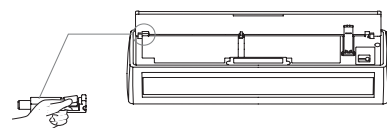

4. Connecting the indoor/outdoor Electric Cable

Removing the wiring cover

- Remove terminal cover at right bottom corner of indoor unit, then take off wiring cover by removing its screws.

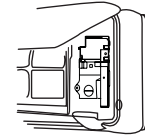

When connecting the cable after installing the indoor unit

- Insert from outside the room cable into left side of the wall hole, in which the pipe has already existed.
- Pull out the cable on the front side, and connect the cable making a loop.

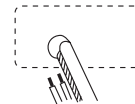

When connecting the cable before installing the indoor unit

- Insert the cable from the back side of the unit, then pull it out on the front side.
- Loosen the screws and insert the cable ends fully into terminal block, then tighten the screws.
- Pull the cable slightly to make sure the cables have been properly inserted and tightened.
- After the cable connection, never fail to fasten the connected cable with the wiring cover.

Note: When connecting the cable, confirm the terminal number of indoor and outdoor units carefully. If wiring is not correct, proper operation can not be carried out and will cause defect.

- If the supply cord is damaged, it must be replaced by the manufacturer or its service agent or a similar qualified person. The type of connecting wire is H05/07RN-F or 245IEC57(YZW).
- If the fuse on PC board is broken please change it with the type of T. 3.15A/250V.
- The wiring method should be in line with the local wiring standard.
- After installation, the power plug should be easily reached.
- A breaker should be incorporated into fixed wiring. The breaker should be all-pole switch and the distance between its two contacts should be not less than 3mm.

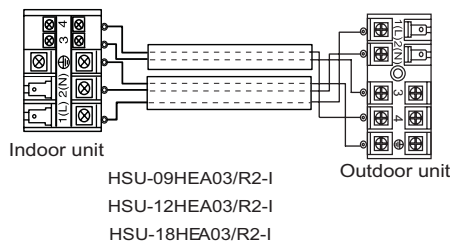
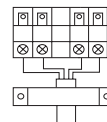
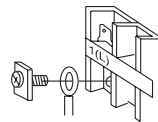
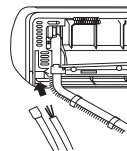

Power cable:

-mod 09-12-18: $\geq 3\text{G}1.0\text{mm}^2$

connecting wiring:

-mod 09-12: L, N, \oplus : $\geq 3\text{G}1.0\text{mm}^2$
3, 4: $\geq 2\text{X}0.75\text{mm}^2$

-mod18: L, N, \oplus : $\geq 3\text{G}2.5\text{mm}^2$
3, 4: $\geq 2\text{X}0.75\text{mm}^2$

Outdoor unit

1. Installation of Outdoor Unit

Install according to 

2. Connection of pipes

- To bend a pipe, give the roundness as large as possible not to crush the pipe, and the bending radius should be 30 to 40 mm or longer.
- Connecting the pipe of gas side first makes working easier.
The connection pipe is specialized for R410A.

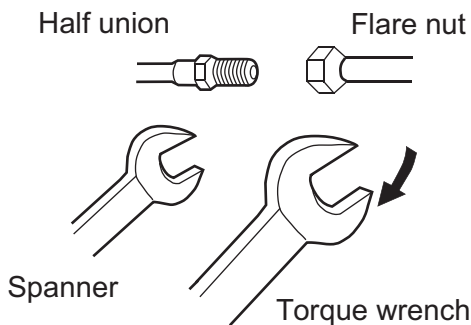

Forced fastening without careful centering may damage the threads and cause a leakage of gas.

Pipe Diameter (ϕ)	Fastening torque
Liquid side 6.35mm(1/4")	18N.m
Liquid side 9.52mm(3/8")	42 N.m
Gas side 12.7mm(1/2")	55N.m
Gas side 15.88mm(5/8")	60 N.m

Be careful that matters, such as wastes of sands, etc. shall not enter the pipe.

The standard pipe length is 7.5m. If it is over 10m, the function of the unit will be affected. If the pipe has to be lengthened, the refrigerant should be charged, according to 20 g/m. But the charge of refrigerant must be conducted by professional air conditioner engineer. Before adding additional refrigerant, perform air purging from the refrigerant pipes and indoor unit using a vacuum pump, then charge additional refrigerant.

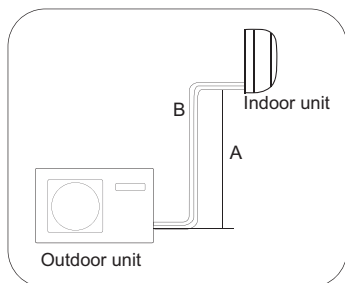

CAUTION

- Max. Elevation: A1=10m(for: 09k 12k), A2=15m(for: 18k)
- In case the elevation A is more than 5m, oil trap should be installed every 5~7m

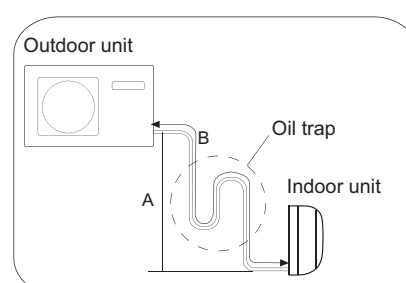
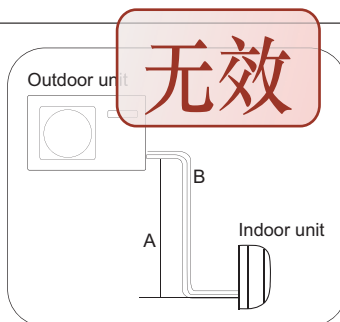

In case A is more than 5m

- Max. Length: B1=15m(for: 09k 12k), B2=25m(for: 18k)
- In case the pipe length B is more than 10m, the refrigerant should be charged, according to 20 g/m.

3. Connection

- Use the same method on indoor unit. Loosen the screws on terminal block and insert the plugs fully into terminal block, then tighten the screws.
- Insert the cable according to terminal number in the same manner as the indoor unit.
- If wiring is not correct, proper operation can not be carried out and controller may be damaged.
- Fix the cable with a clamp.

4. Attaching Drain-Elbow

- If the drain-elbow is used, please attach it as figure.

Note: Only for heat pump unit.

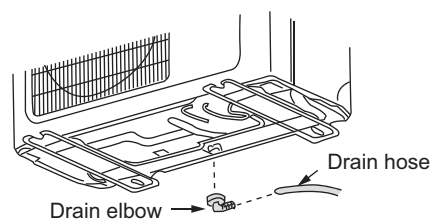

Outdoor unit

5. Purging Method: To use vacuum pump

① Detach the service port's cap of 3-way valve, the valve rod's cap for 2-way valve and 3-way's, connect the service port into the projection of charge hose (low) for gaugemanifold. Then connect the projection of charge hose (center) for gaugemanifold into vacuum pump.

② Open the handle at low in gaugemanifold, operate vacuum pump. If the scale-moves of gauge (low) reach vacuum condition in a moment, check ① again.

③ Vacuumize for over 15min. And check the level gauge which should read -0.1 MPa (-76 cm Hg) at low pressure side. After the completion of vacuumizing, close the handle 'Lo' in gaugemanifold and stop the operation of the vacuum pump. Check the condition of the scale and hold it for 1-2min. If the scale-moves back in spite of tightening, make flaring work again, the return to the beginning of ③..

④ Open the valve rod for the 2-way valve to an angle of anticlockwise 90 degrees. After 6 seconds, close the 2-way valve and make the inspection of gas leakage.

⑤ No gas leakage? In case of gas leakage, tighten parts of pipe connection. If leakage stops, then proceed ⑥ steps.

⑥ Detach the charge hose from the service port, open 2-way valve and 3-way. Turn the valve rod anticlockwise until hitting lightly.

⑦ To prevent the gas leakage, turn the service port's cap, the valve rod's cap for 2-way valve and 3-way's a little more than the point where the torque increases suddenly.

⑧ After attaching the each caps, check the gas leakage around the caps.

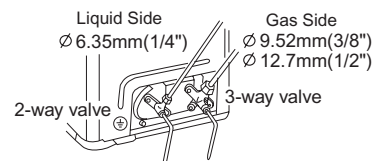
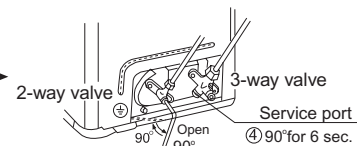
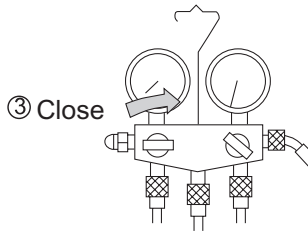
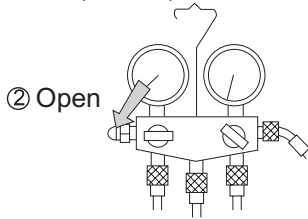
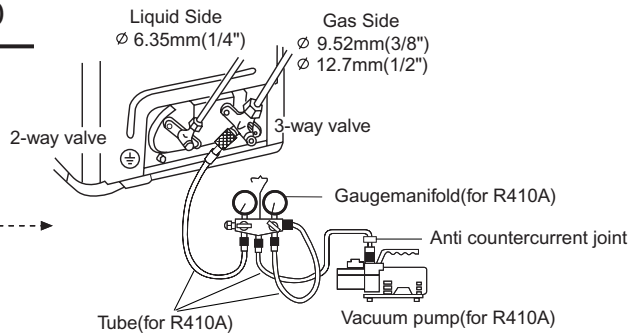

If it does not stop gas leakage, discharge whole refrigerants from the service port. After flaring work again and vacuumize, fill up prescribed refrigerant from the gas cylinder

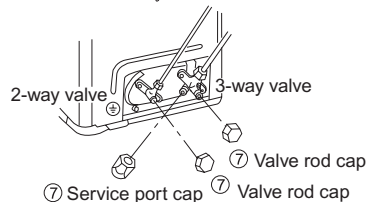
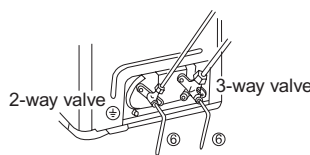

CAUTION:

1.If the refrigerant of the air conditioner leaks, it is necessary to discharge all the refrigerant. Vacuumize first, then charge the liquid refrigerant into air conditioner according to the amount marked on the name plate.

2.Please do not let other cooling medium, except specified one (R410A), or air enter into the cooling circulation system. Otherwise, there will be abnormal high pressure in the system to make it crack and lead to personal injuries.

1. Power Source Installation

- The power source must be exclusively used for air conditioner. (Over 10A)
- In the case of installing an air conditioner in a moist place, please install an earth leakage breaker.
- For installation in other places, use a circuit breaker as far as possible.

2. Cutting and Flaring Work of Piping

- Pipe cutting is carried out with a pipe cutter and burs must be removed.
- After inserting the flare nut, flaring work is carried out.

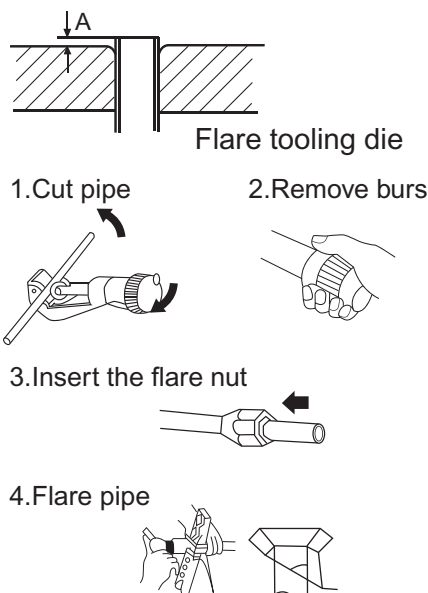

	Flare tool for R410A	Conventional flare tool	
	Clutch-type	clutch-type(Rigid-type)	Wing-nut type (Imperial-type)
A	0~0.5mm	1.0~1.5mm	1.5~2.0mm

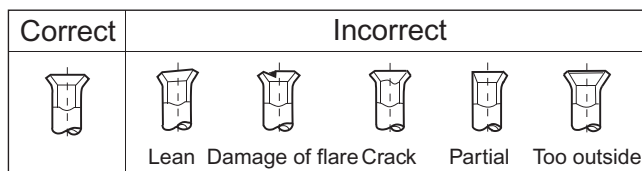

3. On Drainage

Please install the drain hose so as to be **无效** (invalid) without fail.
Please don't do the drainage as shown below.

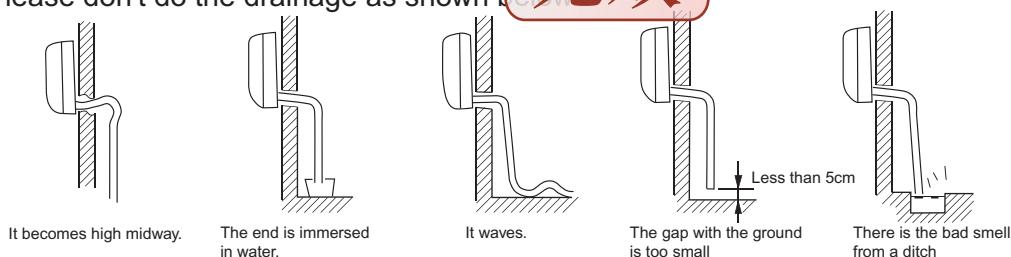

- Please pour water in the drain pan of the indoor unit, and confirm that drainage is carried out surely to outdoor.
- In case that the attached drain hose is in a room, please apply heat insulation to it without fail.

Check for Installation and Test Run

- Please kindly explain to our customers how to operate through the instruction manual.

Check Items for Test Run

Put check mark ✓ in boxes

- | | | |
|--|--|--|
| <input type="checkbox"/> Gas leak from pipe connecting? | <input type="checkbox"/> Is drainage securely carried out? | <input type="checkbox"/> Is the lamp normally lighting? |
| <input type="checkbox"/> Heat insulation of pipe connecting? | <input type="checkbox"/> Is the earth line securely connected? | <input type="checkbox"/> Are cooling and heating (when in heat pump) performed normally? |
| <input type="checkbox"/> Are the connecting wirings of indoor and outdoor firmly inserted to the terminal block? | <input type="checkbox"/> Is the indoor unit securely fixed? | <input type="checkbox"/> Is the operation of room temperature regulator normal? |
| <input type="checkbox"/> Is the connecting wiring of indoor and outdoor firmly fixed? | <input type="checkbox"/> Is power source voltage abided by the code? | |
| | <input type="checkbox"/> Is there any noise? | |

Haier

AIR CONDITIONERS

Haier Industrial Park, No.1 Haier Road, Qingdao, P.R.China

IT CONFORMITÀ ALLE DIRETTIVE EUROPEE PER I MODELLI:

CE

Tutti i prodotti sono conformi alle seguenti normative europee:

- Direttiva 73/23/EEC Basso Voltaggio
- Direttiva 2006/95/EC Basso Voltaggio
- Direttiva 89/336/EEC Compatibilità elettromagnetica
- Direttiva 2004/108/EC Compatibilità elettromagnetica

ROHS

Il prodotto è conforme alla normativa 2002/95/EEC sulla restrizione d'uso di sostanze inquinanti negli apparecchi elettrici ed elettronici.

WEEE

Informativa al consumatore come previsto dalla normativa europea 2002/96/CE riguardante i rifiuti di apparecchiature elettriche ed elettroniche.

SPECIFICHE DI SMALTIMENTO:



Il climatizzatore è contrassegnato con questo simbolo, ciò significa che i prodotti elettrici ed elettronici non possono essere smaltiti insieme ai rifiuti domestici non differenziati. Non cercare di demolire il sistema da soli: la demolizione dei sistemi di condizionamento, nonché il recupero del refrigerante, dell'olio e di qualsiasi altra parte devono essere eseguiti da un installatore qualificato in conformità alla legislazione locale e nazionale vigente in materia. I climatizzatori devono essere trattati presso una struttura specializzata nel riutilizzo, riciclaggio e recupero dei materiali. Il corretto smaltimento del prodotto eviterà le possibili conseguenze negative all'ambiente e alla salute dell'uomo. Per maggiori informazioni contattare l'installatore o le autorità locali. Le batterie devono essere tolte dal telecomando e smaltite separatamente conformemente alla legislazione locale e nazionale vigente in materia.

EN EUROPEAN REGULATIONS CONFORMITY FOR THE MODELS:

CE

All the products are in conformity with the following European provision:

- Low Voltage Directive 73/23/EEC
- Low Voltage Directive 2006/95/EC
- Electromagnetic Compatibility 89/336/EEC
- Electromagnetic Compatibility 2004/108/EC

ROHS

The products are fulfilled with the requirements in the directive 2002/95/EEC of the European parliament and of the council on the Restriction of the use of Certain Hazardous Substances in Electrical and Electronic Equipment (EU RoHS Directive).

WEEE

In accordance with the directive 2002/96/CE of the European parliament, herewith we inform the consumer about the disposal requirements of the electrical and electronic products.

DISPOSAL REQUIREMENTS:



Your air conditioning product is marked with this symbol. This means that electrical and electronic products shall not be mixed with unsorted household waste. Do not try to dismantle the system yourself: the dismantling of the air conditioning system, treatment of the refrigerant, of oil and of other part must be done by a qualified installer in accordance with relevant local and national legislation. Air conditioners must be treated at a specialized treatment facility for re-use, recycling and recovery. By ensuring this product is disposed of correctly, you will help to prevent potential negative consequences for the environment and human health. Please contact the installer or local authority for more information. Battery must be removed from the remote controller and disposed of separately in accordance with relevant local and national legislation.

FR CONFORMITÉ AUX DIRECTIVES EUROPÉENNES POUR LES MODÈLES:

CE

Tous les produits sont conformes aux directives européennes suivantes:

- Directive 73/23/CEE Basse tension
- Directive 2006/95/CE Basse tension
- Directive 89/336/CEE Compatibilité électromagnétique
- Directive 2004/108/CE Compatibilité électromagnétique

ROHS

L'appareil est conforme à la directive 2002/95/CEE relative à la limitation de l'utilisation de certains substances dangereuses dans les équipements électriques et électroniques.

DEEE (WEEE)

Information au consommateur comme le prévoit la directive européenne 2002/96/CE relative aux déchets d'équipements électriques et électroniques.

SPECIFICATIONS POUR L'ELIMINATION:



Ce pictogramme, apposé sur le climatiseur, signifie que les équipements électriques et électroniques ne peuvent pas être éliminés avec les déchets ménagers non triés. Ne pas essayer de démonter l'équipement soi-même: le démantèlement des systèmes de climatisation, ainsi que la récupération du frigorigène, de l'huile et de toute autre partie doivent être effectués par un installateur qualifié conformément à la législation locale et nationale en vigueur en la matière. Les climatiseurs doivent être traités dans un centre spécialisé dans la réutilisation, le recyclage et la valorisation des matériaux. L'élimination correcte de ces appareils permet d'éviter les effets nocifs sur l'environnement et la santé humaine. Pour plus de renseignements contacter l'installateur ou les autorités locales. Les piles doivent être retirées de la télécommande et éliminées séparément, conformément à la législation locale et nationale en vigueur en la matière.

ES CONFORMIDAD EUROPEA DE LAS REGULACIONES PARA LOS MODELOS:

CE

Todos los productos están en conformidad con las siguientes Normativas Europeas:

- Bajo Voltaje directiva 73/23/EEC
- Bajo Voltaje directiva 2006/95/EC
- Compatibilidad electromagnética 89/336/EEC
- Compatibilidad electromagnética 2004/108/EC

ROHS

Los productos cumplen los requisitos de la directiva 2002/95/EEC del parlamento Europeo y el consejo regulador Del uso de materiales peligrosos en equipamientos eléctricos Y electrónicos. (EU RoHS Directiva).

WEEE

De acuerdo con la directiva 2002/96/CE del parlamento Europeo, Informamos al consumidor acerca del reciclaje de los productos Electrónicos y eléctricos.

REQUISITOS PARA LA ELIMINACIÓN:

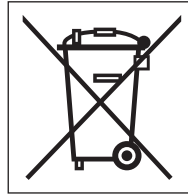

Su acondicionador de aire está marcado con este símbolo. Esto significa que los productos eléctricos y electrónicos no deben mezclarse con el resto de residuos domésticos no clasificados.

No intente desmontar el sistema usted mismo: El desmantelamiento del acondicionador de aire, así como el tratamiento del refrigerante, aceite y otros componentes, debe ser efectuado por un instalador competente de acuerdo con las normas locales y nacionales aplicables.

Los acondicionadores de aire deben ser tratados en instalaciones especializadas para su reutilización, reciclaje y recuperación. Al asegurarse de desechar este producto de la forma correcta, está contribuyendo a evitar posibles consecuencias negativas para el entorno y para la salud de las personas. Contacte, por favor, con el instalador o con las autoridades locales para obtener más información. Las pilas del control remoto deben extraerse y eliminarse por separado y de acuerdo con la normativa local y nacional aplicable.

Haier

AIR CONDITIONERS

Haier Industrial Park, No.1 Haier Road, Qingdao, P.R.China

Contains fluorinated greenhouse gases covered by the Kyoto Protocol — A

R410A

1= kg — B

2= kg — C

1+2= kg — D

F
E

IT INFORMAZIONI IMPORTANTI SUL REFRIGERANTE UTILIZZATO

Questo prodotto contiene gas fluorurati ad effetto serra inclusi nel Protocollo di Kyoto. **Non liberare tali gas nell'atmosfera.**

Tipo di refrigerante: **R410A**

Valore GWP*: **1975**

*GWP = *potenziale di riscaldamento globale*

Compilare con inchiostro indelebile,

- 1 la carica di refrigerante di fabbrica del prodotto
- 2 la quantità di refrigerante aggiuntiva nel campo e
- 1+2 la carica di refrigerante totale

sull'etichetta di carica del refrigerante fornita con il prodotto

L'etichetta compilata deve essere collocata in prossimità della portata di carica del prodotto (ad esempio, nell'interno del coperchio della valvola d'intercettazione).

- A contiene gas fluorurati ad effetto serra inclusi nel protocollo di Kyoto
- B carica di refrigerante di fabbrica del prodotto: vedi targhetta con il nome dell'unità
- C quantità di refrigerante aggiuntiva nel campo
- D carica di refrigerante totale
- E unità esterna
- F cilindro del refrigerante e collettore di carica

EN IMPORTANT INFORMATION REGARDING THE REFRIGERANT USED

This product contains fluorinated greenhouse gases covered by the Kyoto Protocol. **Do not vent into the atmosphere.**

Refrigerant type: **R410A**

GWP* value: **1975**

*GWP = *global warming potential*

Please fill in with indelible ink,

- 1 the factory refrigerant charge of the product
- 2 the additional refrigerant amount charged in the field and
- 1+2 the total refrigerant charge

on the refrigerant charge label supplied with the product.

The filled out label must be adhered in the proximity of the product charging port (e.g. onto the inside of the stop valve cover).

- A contains fluorinated greenhouse gases covered by the Kyoto Protocol
- B factory refrigerant charge of the product: see unit name plate
- C additional refrigerant amount charged in the field
- D total refrigerant charge
- E outdoor unit
- F refrigerant cylinder and manifold for charging

FR INFORMATION IMPORTANTE RELATIVE AU RÉFRIGÉRANT UTILISÉ

Ce produit contient des gaz à effet de serre fluorés encadrés par le protocole de Kyoto. **Ne pas laisser les gaz s'échapper dans l'atmosphère.**

Type de réfrigérant: **R410A**

Valeur GWP*: **1975**

*GWP = *potentiel de réchauffement global*

Prière de compléter à l'encre indélébile,

- 1 la charge de réfrigérant d'usine du produit
- 2 la quantité de réfrigérant supplémentaire chargée sur place et
- 1+2 la charge de réfrigérant totale

sur l'étiquette de charge de réfrigérant fournie avec le produit.

L'étiquette complétée doit être apposée à proximité de l'orifice de recharge du produit (par ex. à l'intérieur du couvercle de la vanne d'arrêt).

- A contient des gaz à effet de serre fluorés encadrés par le protocole de Kyoto
- B charge de réfrigérant d'usine du produit: voir plaquette signalétique de l'unité
- C quantité de réfrigérant supplémentaire chargée sur place
- D charge de réfrigérant totale
- E unité extérieure
- F cylindre de réfrigérant et collecteur de recharge

Contains fluorinated greenhouse gases covered by the Kyoto Protocol — A

R410A

1= kg — B

2= kg — C

1+2= kg — D

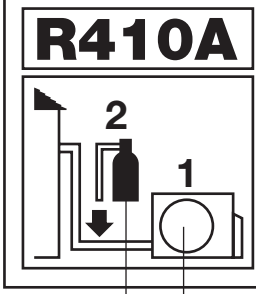

F E

ES INFORMACIÓN IMPORTANTE EN RELACIÓN AL REFRIGERANTE UTILIZADO

Este producto contiene los gases fluorados de efecto invernadero regulados por el Protocolo de Kioto. **No vierta gases a la atmósfera.**

Tipo de refrigerante: **R410A**

Valor GWP*: **1975**

*GWP = *Potencial de calentamiento global*

Rellene con tinta indeleble,

- 1 la carga de refrigerante de fábrica del producto
- 2 la cantidad adicional de refrigerante cargado en campo y
- 1+2 la carga total de refrigerante

En la etiqueta de carga de refrigerante suministrada con el producto.

La etiqueta rellena debe pegarse cerca de la conexión de carga del producto (p.ej. en el interior de la cubierta de la válvula de tope).

- A Contiene los gases fluorados de efecto invernadero regulados por el Protocolo de Kioto
- B Carga de refrigerante de fábrica del producto: véase placa de especificaciones técnicas de la unidad
- C Cantidad adicional de refrigerante cargado en campo
- D Carga total de refrigerante
- E Unidad exterior
- F Cilindro del refrigerante y dosificador de carga

Free Manuals Download Website

<http://myh66.com>

<http://usermanuals.us>

<http://www.somanuals.com>

<http://www.4manuals.cc>

<http://www.manual-lib.com>

<http://www.404manual.com>

<http://www.luxmanual.com>

<http://aubethermostatmanual.com>

Golf course search by state

<http://golfingnear.com>

Email search by domain

<http://emailbydomain.com>

Auto manuals search

<http://auto.somanuals.com>

TV manuals search

<http://tv.somanuals.com>