



HANNspree

138,7cm (54.6")

Liquid Crystal Display Television

Flüssigkristallbildschirm

Téléviseur à Écran à Cristaux Liquides

TV de Pantalla de Cristal Líquido

TV LCD

TV Ecrã de Cristais Líquidos

ЖКД ТВ

LCD-tv

Telewizor ciekłokrystaliczny

LCD TV

LCD TV

LCD TV

LCD TV

Folyadékkristályos TV

РК-телевизор

Televizoru LDC

LCD телевизор

TV cu LCD

LCD TV

Televizora s ekranom od tekućih kristala

User's Manual

Table of Contents

Regulatory Information	3
Description of Warning Symbols	3
Safety Notices	4
Preface	6
Warranty and Service	6
1. Getting Started	8
1.1 Package Contents	8
1.2 Introducing the TV	9
1.3 Features	9
1.4 Control Panel	10
1.5 Input and Output Jacks	10
1.6 Remote Control	12
1.7 Inserting the Remote Control Batteries	16
2. Setting up your TV	18
2.1 Basic Connections	18
2.1.1 Power Connection	18
2.1.2 Connecting an Antenna or Cable TV	18
2.2 Connecting External Devices	19
2.2.1 Connecting External Earphones	19
2.2.2 Connecting to AV Devices	20
2.2.3 Connecting a VCR/ STB/ DVD Player Using Component Video/Audio, Composite Video/Audio, or S-Video/Audio	21
2.2.4 Connecting a PC using VGA	22
2.2.5 Connecting a PC using DVI	22
2.2.6 Connecting HDMI	23
2.2.7 Connecting USB	23
2.2.8 Connecting a VCR/ STB/ DVD Player using SCART	24
2.3 Using the TV	25
2.3.1 Turning the TV On and Off	25
2.3.2 Switching Source Signals	25
2.3.3 Performing an Automatic Channel Search	25
2.3.4 Selecting Channels	25
2.3.5 Adjusting the Volume	25
3. Adjusting On-Screen Display (OSD) Settings	26
3.1 OSD Setting Menus	27

Table of Contents

3.2 Adjusting Picture Settings	27
3.3 Adjusting Sound Settings	28
3.4 Adjusting Channel Settings for ATV (Analogue TV)	28
3.5 Adjusting DTV Settings	30
3.6 Adjusting PC Settings	33
3.7 Adjusting Setup Settings	34
4. Troubleshooting	36
5. Support Timing	37
6. Specifications	38
7. Disassembling the stand base	39
8. Using the Cable Organizer	40

Regulatory Information

CE Conformity Statement

This device is in conformity with the requirements of EU Council Directive 2004/108/EC on the approximation of the laws of the Member States relating to electromagnetic compatibility and Directive 2006/95/EC on the harmonization of the laws of Member States relating to electrical equipment for use within certain voltage limits. Hannspree cannot accept responsibility for any failure to satisfy the requirements resulting from a non-recommended modification of the device.

Description of Warning Symbols



WARNING



This symbol is used to alert users to pay attention to important descriptions regarding usage, maintenance (repair), and additional important information related to this TV.

CAUTION



This symbol is used to alert users to the risk of electric shocks due to dangerous and uninsulated components.

Safety Notices



Installation Safety Notes

Location

Avoid allowing the TV to get prolonged exposure to sunlight or other strong sources of heat. Leave sufficient distance between the TV and the wall to provide enough space for the emission of heat.



WARNING

To reduce the risk of fire or electric shock, do not expose this apparatus to rain or moisture.

Apparatus shall not be exposed to dripping or splashing and no objects filled with liquids, such as vases, shall be placed on the apparatus.



CAUTION

These servicing instructions are for use by qualified service personnel only. To reduce the risk of electric shock, do not perform any servicing other than that contained in the operating instructions unless you are qualified to do so.

Notes:

- **The LCD TV is for entertainment use only and visual display tasks are excluded.**
- **This device uses a VGA connector to connect to a PC. To reduce the influence of main frequency on the source signal, use a VGA monitor cable with ferrite shield.**

Personal Safety

1. To avoid overloading the power supply, never plug too many electrical devices into an outlet, power strip, or extension cable.
 2. Dangerous high-voltage electric power components are located inside the TV. To avoid electric shock, do not disassemble the casing.
 3. Do not place or drop metals, small objects, or flammable materials into the vent of the TV.
 4. If the TV is dropped, falls down, or is otherwise damaged, unplug the power cord immediately and contact an authorized service technician.
 5. If any fluid is sprayed or dropped into the TV, contact an authorized service technician.
 6. The screen of the TV is made of glass. Avoid hitting or scraping it. If the screen is broken, do not touch the broken glass.
 7. Do not allow children to use the TV unattended.
 8. Be careful when disconnecting the power plug. Hold the plug. Do not attempt to disconnect the plug by pulling on the power cord.
-

Installation

1. Do not place the TV in locations where there is excessive steam or dust.
 2. Avoid blocking the TV's vents, do not place the TV on a bed, sofa, carpet, or in a sealed cabinet.
 3. Install the outdoor antenna away from power transmission lines to avoid possible danger.
-



Preface

Thank you for purchasing a Hannspree Liquid Crystal Display Television (LCD TV). Your new TV will allow you to enjoy superior audio and video while enriching your lifestyle with advanced technology.

Please carefully read this manual in its entirety before setting up, using or operating your TV. To ensure the safe and correct installation and operations of the TV, it is important that the safety and operation instructions in this manual are followed.

This instruction manual is designed to assist you in setting up and using the TV. The information in this manual has been carefully checked for accuracy; however, no guarantee is given to the correctness of the contents. The information in this manual is subject to change without notice.

To the extent allowed by applicable law, Hannspree, Inc. ("Hannspree") shall not be liable for direct, indirect, special, exemplary, incidental or consequential damages arising from any defect or omission in this manual, even if advised of the possibility of such damages in advance.



Warranty and Service

For complete warranty service information, please refer to the "Warranty Card" enclosed with your TV.

Copyright

© Copyright 2010 Hannspree, Inc.

All rights reserved. This manual is protected by copyright and distributed under licenses restricting its use, copying and distribution. No part of this manual may be reproduced in any form by any means without the prior written authorization of Hannspree. The TV described in this manual may include copyrighted software of Hannspree (or other third parties). Hannspree (or other third parties) preserves the exclusive rights for copyrighted software, such as the right to distribute or reproduce the copyrighted software. Accordingly, and to the extent allowed by applicable law, any copyrighted software contained in the product described herein shall not be distributed, modified, reverse engineered, or reproduced in any manner without the prior written authorization of Hannspree (or of other third parties).

The Hannspree logos presented herein are trademarks of Hannspree. All other product names, trademarks or logos mentioned herein are used for identification purpose only, and may be the trademarks or registered trademarks of their respective owners.

The purchase of the product described herein shall not be deemed to grant, either directly or by implication, estoppel or otherwise, any license under the copyrights, patents, patent applications or trademarks of Hannspree, except for the normal, non-exclusive use that arises by operation of law in the sale of a product.

Trademark Notice

HDMI Hannspree products incorporate High-Definition Multimedia Interface (HDMI™) technology.

HDMI, the HDMI logo and High-Definition Multimedia Interface are trademarks or registered trademarks of HDMI Licensing LLC.

1.1 Package Contents

Make sure the following components are included in the box. Please contact Hannspree Customer Service immediately if anything is missing or damaged.

- TV
- User's manual
- Quick start guide
- Warranty card
- Power cord
- Remote control and batteries
- TV cleaning cloth
- Rubber cover



ME61



According to WEEE regulation, this TV can't be handled as normal trash in Europe when it is out of usage. Please refer to the recycle information from our website to handle it.

As an ENERGY STAR[®] Partner, Hannspree has determined that this product meets the ENERGY STAR[®] guidelines for energy efficiency.

1.2 Introducing the TV

You can watch SECAM/ PAL/ DVB-T broadcast, cable, or digital television channels, and easily connect a VCR, STB or DVD player to the SCART, HDTV (Component), AV(Composite), and HDMI input ports (locations of these ports depend on the model). You can also use the TV as a monitor for your PC by connecting it through the VGA port.

Convenient control buttons located on the TV and a handy remote control let you change channels, adjust the volume, and change display settings through an easy-to-use on-screen display menu system. The built-in stereo speakers provide full rich sound and a convenient audio output port lets you connect to an external audio system or earphones.

1.3 Features

- TV Tuner: Built-in TV Tuner
- Audio/ Video support:
 - SCART inputs
 - VGA (PC) input
 - HDMI inputs
 - HDTV (Component) input
 - R/L audio inputs
 - PC Audio In
 - 3.5 mm stereo earphone output
 - AV(Composite) input
 - S-Video
- On-Screen Display (OSD) menu
- Teletext (TV RF+SCART) 1.5v with 500 pages memory
- Built-in stereo speakers
- Image Enhancement Technology
 - 3:2/2:2 pull down
 - 3D Comb Filter
 - HD-ready TV
- Noise Reduction
- Advanced 3D de-interlacing
- Edge Enhancement

Note:











- The supporting devices mentioned in this manual may vary on different models. For more information, please refer to the manufacturer's user manual or the Quick Start Guide of your TV model.







1.4 Control Panel

Description	Button	Function
Power		Press to turn the TV on or off.
Input source	INPUT	Press to select the proper input source.
Menu	MENU	Press to open the OSD menu.
Program select	P▲	Press to increase the program number or move upward to the previous item on the OSD menu.
Program select	P▼	Press to decrease the program number or move downward to the next item on the OSD menu.
Volume adjust	VOL +	Press to increase the volume or move to the right on the OSD menu.
Volume adjust	VOL -	Press to decrease the volume or move to the left on the OSD menu.
Remote IR sensor		Receive incoming remote control commands.
Power/Standby indicator		Indicate power (green) or standby (red) status.
Speakers		Deliver high-quality sounds.

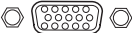
1.5 Input and Output Jacks



Description	Connector	Function
CI	CI 	Connect to a CI device.











Description	Connector	Function
Service		Service only. Not available for users.
S-Video Input		Connect to an external device, such as a VCR, STB, or a DVD player.
Composite Input (Video)		Connect to an external device, such as a VCR, STB, or a DVD player.
Composite Inputs (Audio)		Connect to an external device, such as a VCR, STB, or a DVD player.
Earphone Output		Connect to earphones or external speakers with a built-in amplifier.
Cable/Antenna	 TV/DTV CABLE ANTENNA	Connect to an antenna or cable TV.
Component Inputs (Video)		Connect to an external device, such as a VCR, STB, or a DVD player.
Component Inputs (Audio)		Connect to an external device, such as a VCR, STB, or a DVD player.
SCART 1 IN/OUT	 SCART 1	Connect to an external device, such as a VCR, STB, or a DVD player with AV, S-Video, RGB, L/R IN, Analog TV Out, and L/R Out.
SCART 2 IN	 SCART 2	Connect to an external device, such as a VCR, STB, or a DVD player with AV, S-Video, L/R IN.





Description	Connector	Function
VGA (PC) Input	 VGA	Connect to a PC's VGA port.
PC Audio Input	AUDIO IN 	Connect to a PC's line/audio port.
HDMI 1 Input	HDMI IN 1 	Connect a HDMI equipment or a HDMI-DVI adapter cable to devices such as a DVD player or set-top box.
HDMI 2 Input	HDMI IN 2 	Connect a HDMI equipment or a HDMI-DVI adapter cable to devices such as a DVD player or set-top box.
HDMI 3 Input	HDMI IN 3 	Connect a HDMI equipment or a HDMI-DVI adapter cable to devices such as a DVD player or set-top box.
HDMI 4 Input	HDMI 4 	Connect a HDMI equipment or a HDMI-DVI adapter cable to devices such as a DVD player or set-top box.
Power Connector		Connect to the included power cord.

1.6 Remote Control

Description	Icon	Function
Power		Press to turn the TV on or off.
Input Signal Type	INPUT	Press to select the input signal types: TV, DTV, AV, S-Video, YPbPr, PC, HDMI 1, HDMI 2, HDMI 3, HDMI 4, SCART 1, or SCART 2.

Description	Icon	Function
Keypad	1 2 3 4 5 6 7 8 9 0	Use to select a program directly. Press 0-9 to enter the program numbers (press 1 and 0 for program 10).
Pro.List	Pro.LIST	Press to display the features contained (only for DTV).
Last	LAST 	Press to return to the last channel selected.
Information	INFO	1. Press to display current channel/program information. 2. During DTV menu selection, press to display help information about Channel Organizer, Channel Sorting, Channel Grouping, Time and Parental Rating.
Menu	MENU	Press to turn the on-screen display (OSD) menu on/off.
OK	OK	Press to confirm a selection.
Arrows		Press up, down, left or right to scroll through the on-screen display menus.
Electronic Program Guide	EPG	Press to display detailed programming information for channels (only for DTV).
Teletext mode	TEXT	Press to activate the teletext mode.
Volume adjustment	VOL+ / VOL-	Press VOL + to increase audio volume. Press VOL - to decrease audio volume.
Mute	MUTE 	Press to eliminate the sound. Press it again or press the volume adjustment buttons to restore the sound.

Description	Icon	Function
Dual sound		Press to change the multi sound selection of the TV channel.
Select program		Press P▲ to increase the program number. Press P▼ to decrease the program number.
Red, Green, Yellow, Blue		Press the colored buttons to perform specific tasks in the OSD menu or teletext mode.
Index	INDEX 	Press to display a table of the available teletext subjects (programmable in the teletext mode only).
Mix	MIX 	Press to display the teletext over the program on the screen (programmable in the teletext mode only).
Adjust size	SIZE 	Press to adjust the screen size (programmable in the teletext mode only).
Subtitle	SUBTITLE 	With an ATV source, if the teletext mode is activated and the teletext has a subtitle page, press to display the page. With a DTV source, press to display the subtitle OSD, and select the language.
Hold	HOLD 	Press to inactivate automatic page change which only occurs when more than one teletext page exists. (Programmable in the teletext mode only)
Reveal	REVEAL 	Press to display the hidden information, such as solutions to puzzles. (Programmable in the teletext mode only)
Sound Mode	SOUND 	Press continuously to toggle through all the sound settings: Standard, Music, Movie, Speech, or User.

Description	Icon	Function
Picture Mode	PIC 	Press continuously to toggle through all the picture settings: Vivid, Soft, User, Standard.
Favorite channel	FAV. 	In ATV, press to select favorite channels and press ^ / v to go to favorite channels. In DTV, press to open favorite list menu and press ^ / v to select channels and press OK to go to favorite channels.
Freeze	FREEZE 	Press to pause a video frame on-screen. (Programmable in the ATV source only)
Sleep timer	SLEEP 	Press repeatedly to set the sleep timer (15, 30, 45, 60, 90 or 120 minutes). Cancel the timer by selecting the Sleep Off option.
Aspect ratio	ASPECT 	Press to adjust the width-to-height ratio of the image with aspect ratio: AUTO, Full, Normal, Panorama, Zoom, Subtitle.

Note:

- For best results, use the remote control within a proper distance from the front of the TV. Do not exceed an angle of 30 degrees when pointing at TV.
- The operational distance may be shortened when the signal sensor is directly exposed to strong light.
- Aim the transmitter on the remote control at the signal sensor and ensure that there are no obstacles between them.

1.7 Inserting the Remote Control Batteries

- 1 Open the battery compartment cover at the back of the remote control.

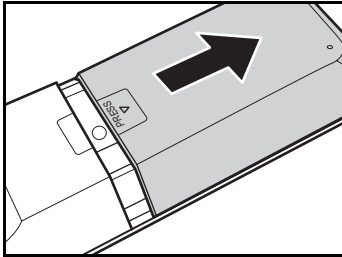

- 2 Insert the batteries paying attention to the polarity markings inside the battery compartment.

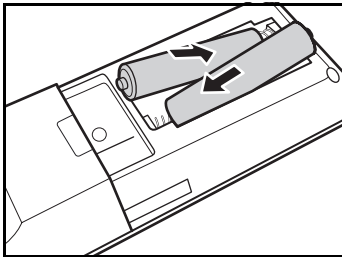

- 3 Replace the battery compartment cover.

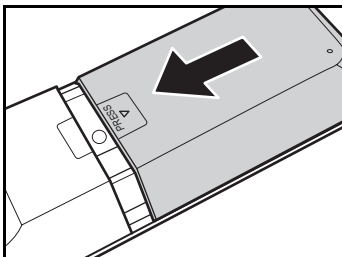



CAUTION

- If the remote control is not used for a long period, remove the batteries and store them properly.
- Handle damaged or leaking batteries carefully, and wash hands with soap if they come in contact with leaked chemical fluids.
- If your remote control has two batteries, do not mix new and old batteries, or the life of the new batteries will be shortened. Chemical fluids may leak from the old batteries.
- Danger of explosion if battery is incorrectly replaced. Replace only with the same or equivalent type recommended by the equipment manufacturer. Discard used batteries according to manufacturer's instructions.
- Refer to your local recycling or waste disposal rules and contact a local waste disposal vendor to dispose of used batteries.
- The remote control cover may have a magnet in it, so do not place magnetic sensitive items such as watches, credit cards, or flash media close to the cover.
- Do not use force when pulling the remote control cover open; you may damage the hinge.

Setting up your TV

2.1 Basic Connections

2.1.1 Power Connection

- 1 Connect the power cord to the AC IN input jack on the rear of the TV.
- 2 Insert the plug at the other end of the power cord into a power outlet.

2.1.2 Connecting an Antenna or Cable TV

Connect one end of the VHF/UHF (Antenna) or CATV cable to TV/DTV jack on the rear of the TV.

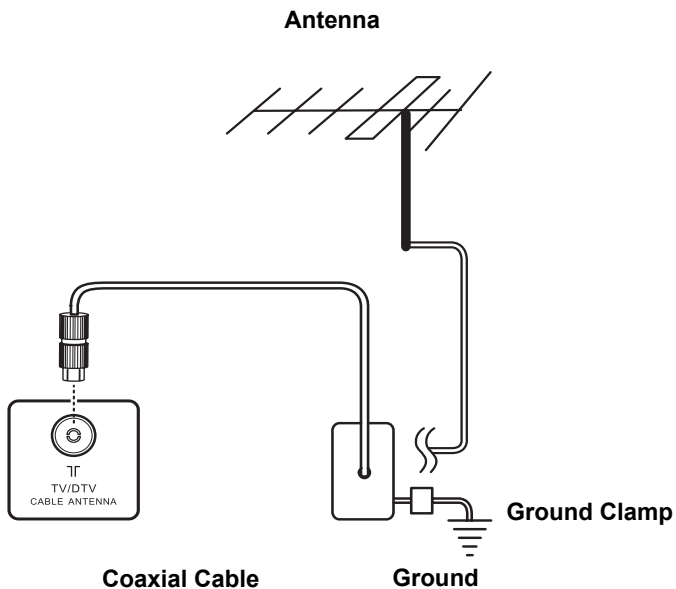

Note:

- Images are for illustration only and may vary by model or region.
- If you cannot receive channels after connecting to an antenna or cable TV line, try scanning for channels.

2.2 Connecting External Devices

Connect external devices such as VCRs, STBs, DVD players, video game consoles, earphones, or a PC to the TV using the appropriate ports on the rear of the TV.

2.2.1 Connecting External Earphones

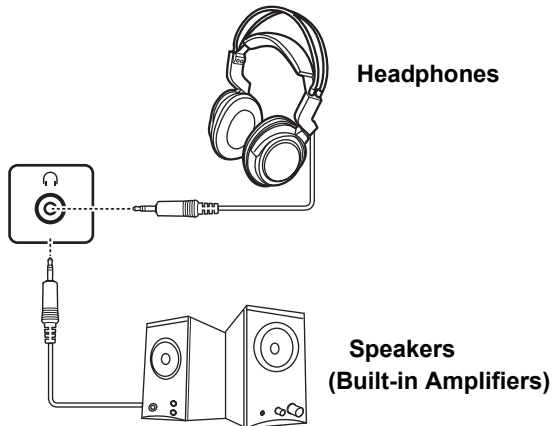
**Note:**

- External speakers or headphones are not included with the TV.
- The internal TV speakers will not output sound when headphones are plugged in.
- Use external speakers with built-in amplifiers only.
- Only one external device for sound can be connected at a time.

2.2.2 Connecting to AV Devices

The following diagram illustrates how to connect the AV devices to your TV via HDMI (A), YPbPr/AUDIO (B), SCART (C), AV/SV (D) ports.

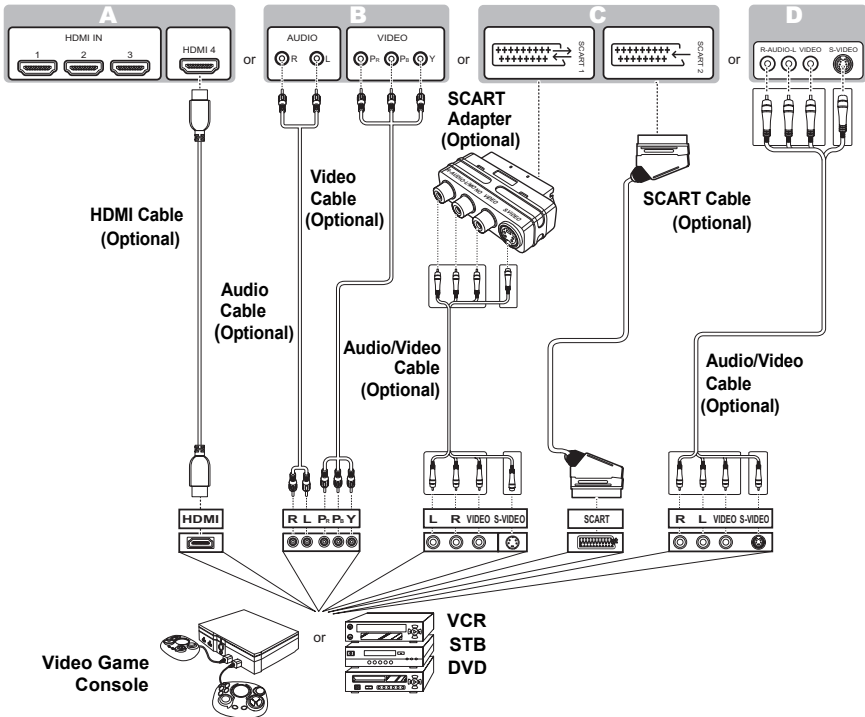

Note:

- Please connect the audio ports shown in YPbPr/AUDIO (B) to audio ports of Component/YPbPr group in your AV device. AV/SV (D) ports should connect AV/SV ones. Only a set of the audio ports can be selected when connecting AV devices.
- The Video and S-Video ports in group (D) share the same R/L Audio ports in the same group.

2.2.3 Connecting a VCR/ STB/ DVD Player Using Component Video/Audio, Composite Video/Audio, or S-Video/Audio

Connect the TV to a VCR/ STB/ DVD player using three different types of video/audio inputs.

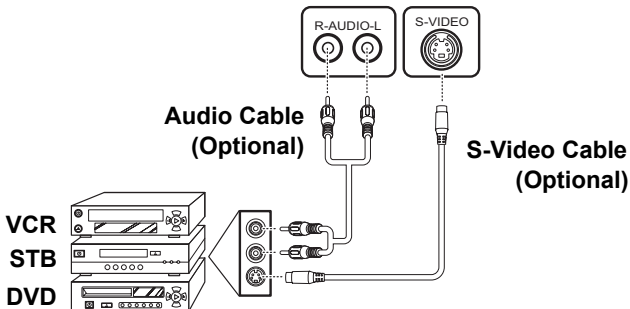
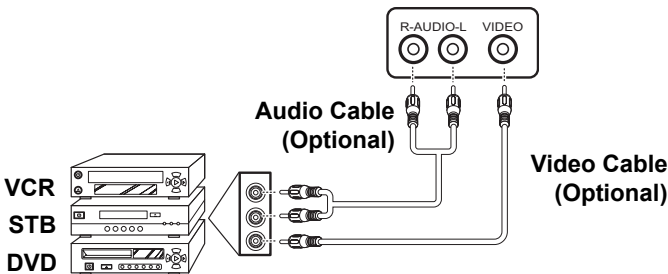
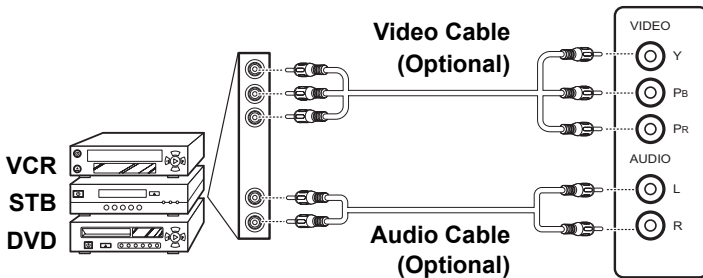

2.2.4 Connecting a PC using VGA

Connect the TV to your PC to use it as the monitor using the VGA port as shown.

- 1 Connect the VGA port of the TV to the VGA output of the PC.
- 2 Connect the line out port of the PC to the PC Audio In port of your TV to listen to audio from the PC.

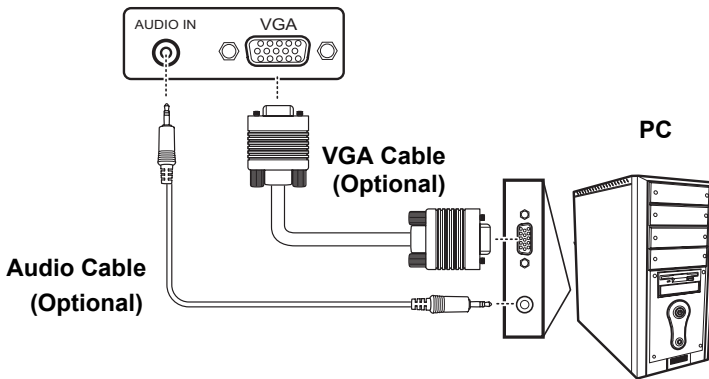

2.2.5 Connecting a PC using DVI

Connect the TV to your PC to use it as the monitor using the DVI port as shown.

- 1 Connect the HDMI port of the TV to the DVI output of the PC.
- 2 Connect the line out port of the PC to the PC Audio In port of your TV to listen to audio from the PC.

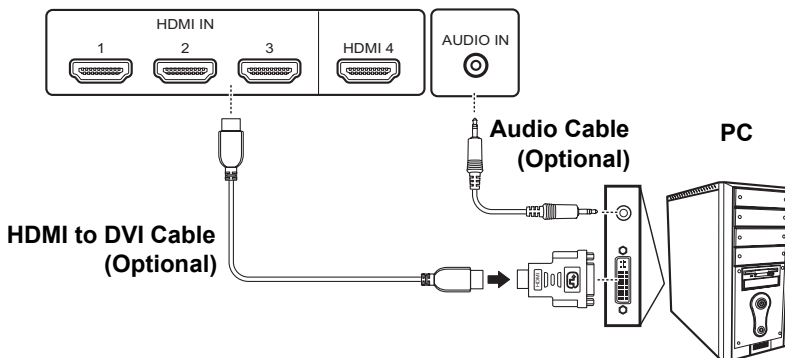

2.2.6 Connecting HDMI

HDMI (High Definition Multimedia Interface) assures that the best video signal is always sent from source to the TV. Refer to the following illustration to connect a HDMI device to the TV.

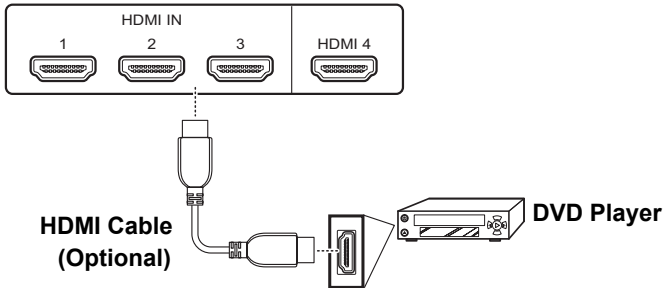

Note:

When the HDMI cable is connected, connecting the audio cable is not necessary. However, it is necessary to do so if a HDMI to DVI cable is connected.

2.2.7 Connecting USB

Service port, for DTV F/W update only.

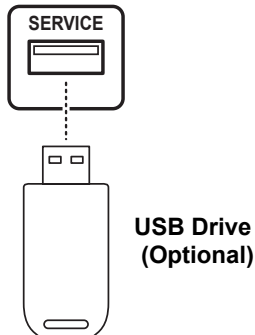

2.2.8 Connecting a VCR/ STB/ DVD Player using SCART

Use the SCART ports to connect a TV, VCR, VCD, DVD player or video game console. You can choose to use a SCART cable or adapter for the connection depending on the ports available on your player.

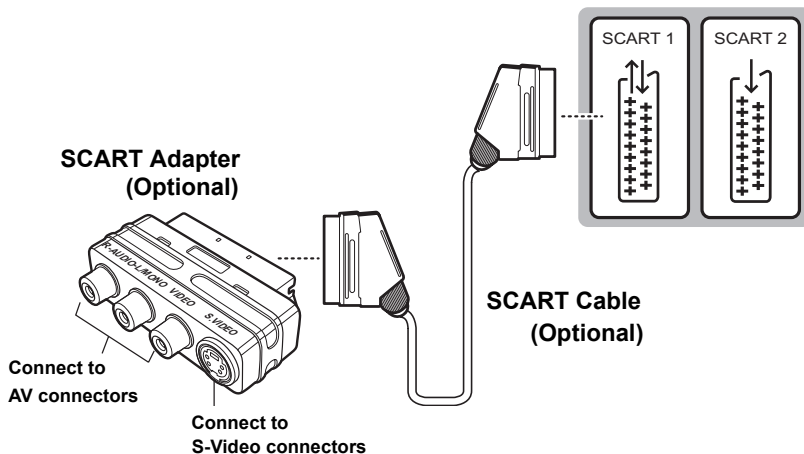



Note:

- The S-Video connector and AV connectors cannot be connected at the same time, or the wrong signals might be generated.
- The cables are color-coded (black, red, white, and yellow). Connect each color-coded cable to the appropriate connector on your device.

2.3 Using the TV

2.3.1 Turning the TV On and Off

- 1 Press  on the control panel or remote control. The power LED indicator on the TV changes from red to green, indicating that the TV is on.
- 2 Press  again. The power LED changes from green to red, indicating that the TV is off.

2.3.2 Switching Source Signals

Press **INPUT** on the control panel or remote control to select the incoming source signal.

2.3.3 Performing an Automatic Channel Search

Before using the TV to view programs, you need to activate the channel search first.

- 1 Press **MENU** on the control panel or remote control, then select to enter the Channel menu.
- 2 Select Auto Search.
- 3 Press  on the remote control to run the channel search.

2.3.4 Selecting Channels

- Press **P▲** on the remote control or control panel to increase the channel number.
- Press **P▼** on the remote control or control panel to decrease the channel number.
- Enter the specific channel number by pressing the number buttons on the remote control.

2.3.5 Adjusting the Volume

- 1 Press **VOL+** on the control panel or remote control to increase the volume.
- 2 Press **VOL-** on the control panel or remote control to decrease the volume.
- 3 Press **MUTE** to eliminate sounds, and press **MUTE** again or press the volume buttons to restore the original volume.

3

Adjusting On-Screen Display (OSD) Settings

The On-Screen Display (OSD) menu system provides a quick and simple method to adjust the TV settings. The OSD menu can be accessed conveniently through the buttons on the remote control.

Before going into details of each OSD option, you may get acquainted with the placement of the OSD system:

CURRENT MENU:

Displays the title of the currently selected menu.

MAIN MENU:

Displays a list of menu items. The selected item is highlighted by a darker blue color than others.

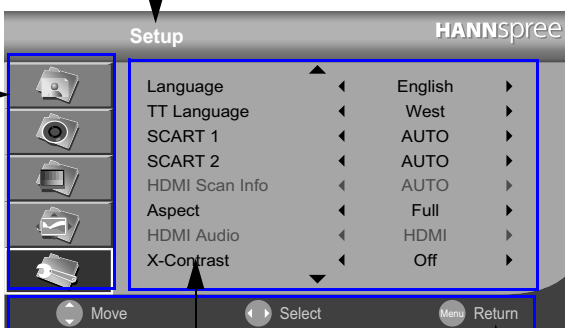

ADJUSTABLE Options:

Displays the setting/value of the adjustable options.

INSTRUCTIONS:

Quick instructions for adjusting the settings.

Function	TV Control Panel	Remote Control
OSD Menu	MENU	MENU
Up	P▲	Arrow ^
Down	P▼	Arrow v
Select/ Increase	VOL +	Arrow >
Select/ Decrease	VOL -	Arrow <
Return	MENU	MENU

3.1 OSD Setting Menus

Follow the instructions indicated on the down side of the OSD Function Menu. Press **P▲/P▼** on the control panel or **^ / v** to scroll through the menus, **VOL +** on the control panel or **>** to select an item, or **MENU** to exit the OSD menu.

The following menus can be set by different adjustment methods.

3.2 Adjusting Picture Settings

- 1 Press **MENU** to enter the OSD Main Menu screen. The **Picture** menu is then displayed.
- 2 Press **>** to enter the **Picture** menu.
- 3 Press **^ / v** to select an item.
- 4 Press **< / >** to adjust the scales or options settings.

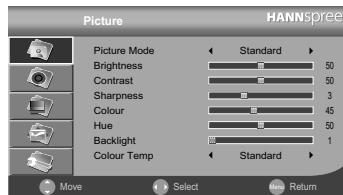

- 5 Press **MENU** to return to the **Picture** menu.
- 6 Press **MENU** to exit the OSD menu.

- The **Picture** menu can be used to adjust the **Picture Mode, Brightness, Contrast, Sharpness, Colour, Hue, Backlight,** and **Colour Temp** settings.

- The **Picture Mode** can be set to **Standard, Vivid, Soft,** or **User**. Please note that all customized picture settings will be saved as the **User** mode. You could also use other modes to get a quick setting switch for different needs.
- The **Brightness, Contrast, Colour,** and **Hue** (NTSC only) can be adjusted by pressing **< / >** to move the scales from **0-100**.
- Press **< / >** to adjust the scales from **0-9** for **Sharpness**.
- The **Backlight** helps to manually turn down the backlight in dark scenes, generating a deeper black color. Press **< / >** to adjust the scales from **1-10**.
- The **Colour Temp** allows you to set the colour temperature. You can choose your favourite from three different modes: **Standard, Warm,** and **Cool**.

Note: The options available on the OSD menu may vary depending on the input signal source.

3.3 Adjusting Sound Settings

- 1 Press **MENU** to enter the OSD Main Menu screen.
- 2 Press \checkmark to select the **Sound** menu.
- 3 Press \triangleright to enter the **Sound** menu.
- 4 Press \wedge / \vee to select an item.
- 5 Press \langle / \rangle adjust the scales or options settings.

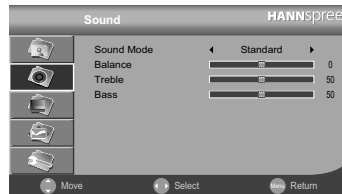

- 6 Press **MENU** to return to the **Sound** menu.
- 7 Press **MENU** to exit the OSD menu.
 - The **Sound** menu can be used to adjust the **Sound Mode**, **Balance**, **Treble**, and **Bass** settings.
 - The **Sound Mode** can be set to **Standard**, **Music**, **Movie**, **Speech**, or **User**.
 - The **Balance** can be adjusted by pressing \langle / \rangle to move the scales from **-50** to **50**.
 - The **Treble** and **Bass** can be adjusted by pressing \langle / \rangle to move the scales from **0-100**.

Note: The options available on the OSD menu may vary depending on the input signal source.

3.4 Adjusting Channel Settings for ATV (Analogue TV)

- 1 Press **MENU** to enter the OSD Main Menu screen.
- 2 Press \checkmark to select the **Channel** menu.
- 3 Press \triangleright to enter the **Channel** menu.
- 4 Press \wedge / \vee to select an item.
- 5 Press \langle / \rangle adjust the scales or options settings.

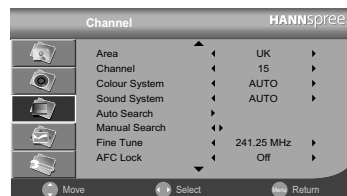

- 6 Press **MENU** to return to the **Channel** menu.
- 7 Press **MENU** to exit the OSD menu.
 - The **Channel** menu can be used to adjust the **Area**, **Channel**, **Colour System**, **Sound System**, **Auto Search**, **Manual Search**, **Fine Tune**, **AFC Lock**, **Channel Edit** and **Parental Lock** settings.

- The **Area** can be set to **Germany, UK, Italy, Spain, Portugal, France, Hungary, Poland, Netherlands,** and **Other**.
- The **Channel** can be used to select channels by pressing **< / >**.
- There are a variety of transmission standards of colour and audio signals used in worldwide TV systems. The **Colour System** and **Sound System** settings allow you to select standards suited for the area where you reside.
- The **Colour System** can be set to **AUTO, PAL,** and **SECAM**.
- The **Sound System** can be set to **AUTO, BG, DK, I, L,** and **L'**.
- Please note that not all combinations of colour and sound systems are available. The setting of one system may then change automatically because of the setting of the other.
- Select **Auto Search** to activate the automatic TV channel search. Select **Manual Search** to scan the TV channels manually.

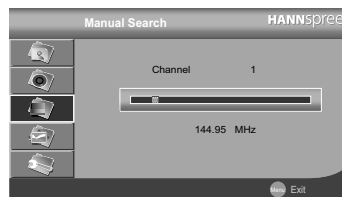
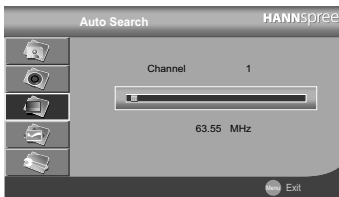

- The **Fine Tune** allows you to make minor frequency alternation to improve the quality of signals. Press **< / >** to adjust the channel frequency.
- To lock on a frequency and let the TV automatically fine-tune it, you can select **On** under the **AFC Lock** option. According to your preference, it can be set to **On** or **Off**.
- The **Channel Edit** enables you to further manage your channel list:

- Just follow the instructions at the bottom of the **Channel Editor** screen to **Skip**, **Delete**, **Swap**, or **Lock** a channel.

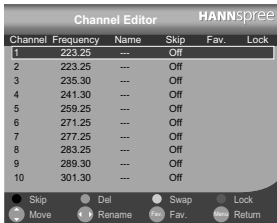

- The functions of naming (**Name**) and marking a channel as a favourite (**Fav.**) are also available. To change the channel name, select the channel and press **< / >** to open the **Channel Editor**. Input the channel name you prefer using the on screen keys and select **Save**.
- You may need to enter your **Parental Lock** password to unblock a channel if you blocked it before.
- The **Parental Lock** allows you to block channels whose programmes are not appropriate for children of certain ages. Set your 4-digit password after entering the **Parental Lock** screen.

Note:

- Before changing any settings under the Channel menu, please make sure that you've already changed the input signal type to (analogue) TV; the Channel menu may vary depending on the selected input signal type.
- Some Channel Settings are only available in (analogue) TV mode.
- The original password is set to 0000 by default.

3.5 Adjusting DTV Settings

- 1 Press **MENU** to enter the OSD Main Menu screen.
- 2 Press **✓** to select the **DTV** menu.
- 3 Press **>** to enter the **DTV** menu.
- 4 Press **^ / v** to select an item.
- 5 Press **< / >** to change scales or settings.
- 6 Press **MENU** to return to the **DTV** menu.
- 7 Press **MENU** to exit the OSD menu.



- The **DTV** menu can be used to adjust the **Channel Management, Area, Auto Search, Manual Search, Preferred Audio, Preferred Subtitle, Parental Lock, Subtitle Type, Time, CI and Parental Rating.**
- Under the submenu of the **Channel Management** option, you can organize, sort, group, or delete TV channels.
- The **Area** can be set to **Germany, UK, Italy, Spain, Portugal, France, Hungary, Poland, Netherlands and Other.**
- Select **Auto Search** to activate the automatic TV and Radio channel search. Select **Manual Search** to look for the TV channels manually.

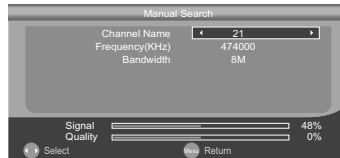
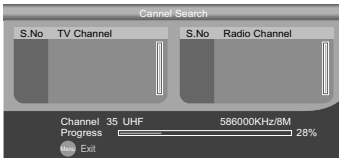

- The **Preferred Audio** language can be set to **English, France, Germany, Italy, Spain, Portugal, Denmark, and Czech.**
- Similarly, you can change your **Preferred Subtitle** language to **English, France, Germany, Italy, Spain, Portugal, Denmark, Czech,** or set it to **Off.**
- The **Channel Organizer** supports channel swap function. To select one channel that you prefer to exchange, press the **Yellow** button on the remote control, then press the numeric button on the remote control to input the channel that you want to exchange with, finally press the **OK** button on the remote control to complete.
- The **Parental Lock** allows you to change the password.



Note:

- The original password is set to **0000** by default.
- Some channel Settings are only available in DTV mode.

- The **Subtitle Type** provides you with **Normal** and **Hearing Impaired** options.
- The **Time** selection includes **GMT Offset** and **Summer Time**.
 - Press **</>** to adjust the **GMT Offset** to **AUTO** or a value ranging from **+12** to **-12**.
 - Press **</>** to adjust **Summer Time** to **On** or **Off**.



- Select **CI** to access the Common Interface.

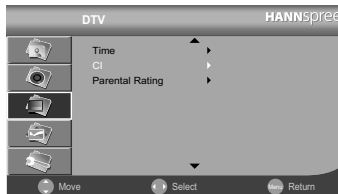

- Press **>** to enter the **Common Interface** menu.
- The **Parental Rating** allows you to select the parental rating.

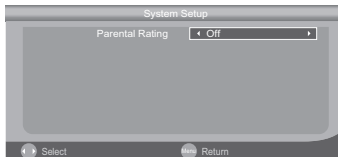

- Press the keypad on the remote control to enter the password.
- Press **</>** to adjust the **Parental Rating** from **4** to **18** or **Off**.

3.6 Adjusting PC Settings

- 1 Press **INPUT** and select **PC** as the signal type.
- 2 Press **MENU** to enter the OSD Main Menu screen.
- 3 Press **✓** to select the **PC** menu.
- 4 Press **➤** to enter the **PC** menu.
- 5 Press **▲ / ▼** to select an item.
- 6 Press **◀ / ▶** adjust the scales or options settings.

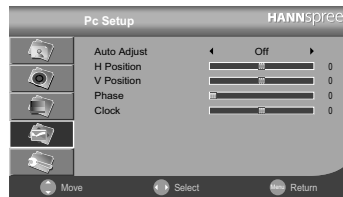

- 7 Press **MENU** to return to the **PC** menu.
- 8 Press **MENU** to exit the OSD menu the OSD menu.
 - The **PC** menu can be used to adjust the **Auto Adjust**, **H Position**, **V Position**, **Phase** and **Clock** settings.
 - You can apply the automatic adjustment by setting **Auto Adjust** at **On**.
 - The scales for **H Position** and **V Position** range from **-16** to **16**.
 - The scales for **Phase** and **Clock** range separately from **0** to **31**, and from **-50** to **50**.

3.7 Adjusting Setup Settings

- 1 Press **MENU** to enter the OSD Main Menu screen.
- 2 Press **✓** to select the **Setup** menu.
- 3 Press **>** to enter the **Setup** menu.
- 4 Press **^ / ✓** to select an item.
- 5 Press **< / >** to change the scales or options settings.
- 6 Press **MENU** to return to the **Setup** menu.
- 7 Press **MENU** to exit the OSD menu.

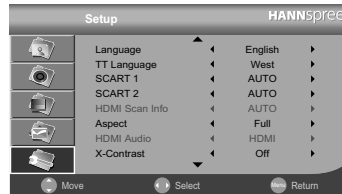

- The **Setup** menu can be used to adjust the **Language**, **TT Language**, **SCART1**, **SCART2**, **HDMI Scan Info**, **Aspect**, **HDMI Audio**, **X-Contrast**, **OSD Time**, **Reset**, **Background**, **Initial Setup**, **Hannsree Light**, and **Vivid Motion** settings.
- The available languages are **English**, **Italiano**, **Español**, **Português**, **Français**, **Deutsch**, **Magyar**, **Polski**, and **Nederlands**.
- The available **TT Language** options are **West**, **East**, **Hungary**, **Arbic**, and **Farsi**.
- The **SCART1** selections include **AUTO**, **CVBS**, **RGB**, and **S-VIDEO**.
- The **SCART2** selections include **AUTO**, **CVBS**, and **S-VIDEO**.
- The available options in **HDMI Scan Info** are **AUTO**, **Overscan**, **Underscan** (available only when HDMI is connected).
- The **Aspect** offers you **AUTO**, **Full**, **Normal**, **Panorama**, **Zoom**, and **Subtitle** options.
- The available **HDMI Audio** selections include **HDMI** and **Analog In** (available only when HDMI is connected).
- The **X-Contrast** can be set to **On** or **Off**.
- **OSD Time** can be set to **10 Secs**, **20 Secs**, **30 Secs**, and **60 Secs**.
- Select **Reset** setting to reset settings to the defaults.
- The **Background** can be set to **Blue** or **Off**.
- Select **Initial Setup** to do auto **Channel Scan**.
- The **Hannsree Light** can be set to **Low**, **Middle**, **High**, and **Off**.
- The **Vivid Motion** can be set to **Low**, **Middle**, **High**, and **Off**.

- The **Aspect** mode selections include **AUTO**, **Full**, **Normal**, **Subtitle**, **Zoom**, and **Panorama**. The following pictures are settings for HDMI/1080P, please see below for details.

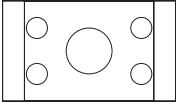
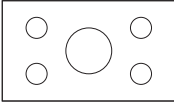
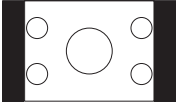
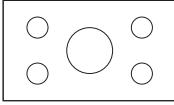
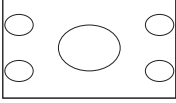
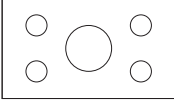
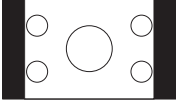
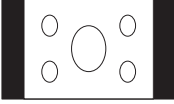
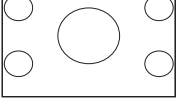
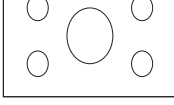
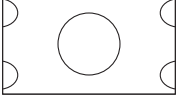
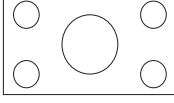
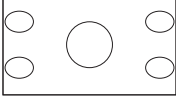
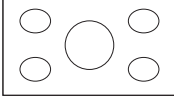
Type	4:3	16:9
Content		
AUTO		
Full		
Normal		
Subtitle		
Zoom		
Panorama		

Note: The options available on the OSD menu may vary depending on the input signal source.

Situation	Solution
No picture and sound.	<ul style="list-style-type: none"> • Connect the power cord properly. • Check if the power LED is on or not. • Press  on the control panel or remote control. • Press Input to cycle through connected video sources. • Press P▲ or P▼ to switch to other TV programs. • Make sure all cables are connected properly.
No picture, or poor picture, sound is OK.	<ul style="list-style-type: none"> • Check the antenna and cable connections. • Adjust the Brightness in the Picture OSD menu.
Picture is not in color.	<ul style="list-style-type: none"> • Adjust the Colour option in the Picture OSD menu.
Picture is OK, no sound.	<ul style="list-style-type: none"> • Make sure the source device is functioning properly. • Make sure the audio cable is connected securely. • Turn the mute off. • Press VOL + on the control panel or remote control.
One of the speakers has no sound.	<ul style="list-style-type: none"> • Adjust the Balance in the Sound OSD menu.
Cannot receive some TV channels using cable TV.	<ul style="list-style-type: none"> • Try the Auto Search function in the Channel (ATV mode) or DTV (DTV mode) OSD menu.
Want to reset TV settings.	<ul style="list-style-type: none"> • Use the Reset function in the Setup OSD menu.
Cannot operate menus.	<ul style="list-style-type: none"> • If OSD items are colored in gray, the system is in a state such that those settings are not available.
Screen image turns over.	<ul style="list-style-type: none"> • Make sure the video signal cable is connected properly.
Snow appears on the screen.	<ul style="list-style-type: none"> • Adjust the location of the antenna, placing it far from roads or sources of interference. • Check the antenna and the video signal line connections.
Blurred or overlapped images.	<ul style="list-style-type: none"> • Adjust the Sharpness setting. • Choose programs with high quality signals. • Adjust the direction of the antenna or replace the video signal cable.
Remote control doesn't work.	<ul style="list-style-type: none"> • Make sure the battery is inserted correctly. • Replace the battery with a new one. • Make sure the TV power cord is plugged in. • Make sure the path between the remote control and the sensor is clear. • Try operating the remote control at a closer distance to the TV.

PC Mode Support Timing

Mode	Resolution (active dot)	Horizontal Frequency (KHz)	Vertical Frequency (Hz)	Nominal Pixel Clock (MHz)	PC (VGA)	DVI to HDMI
VGA	640x480@60Hz	31.469	59.940	25.175	V	V
SVGA	800x600@60Hz	37.879	60.317	40.0	V	V
XGA	1024x768@60Hz	48.363	60.004	65.000	V	V
VESA	1280x720@60Hz	44.955	59.94	74.176	V	
VESA	1280x960@60Hz	60.000	60.000	108.000	V	
SXGA	1280x1024@60Hz	63.981	60.020	108.000	V	V
WXGA+	1440x900@60Hz	55.935	59.887	106.500	V	V
WSXGA+	1680x1050@60Hz	65.29	59.95	146.25		V
VESA	1920x1080@60Hz	66.587	59.93	138.500	V	V

Video Mode Support Timing

Resolution (active dot)	HDMI	HDTV (Component)
640x480p@60Hz	V	
720x480i@60Hz	V	V
720x480p@60Hz	V	V
720x576i@50Hz	V	V
720x576p@50Hz	V	V
1280x720p@60Hz	V	V
1280x720p@50Hz	V	V
1920x1080i@50Hz	V	V
1920x1080i@60Hz	V	V
1920x1080P@24HZ	V	V
1920x1080P@25HZ	V	V
1920x1080P@30HZ	V	V
1920x1080P@50Hz	V	V
1920x1080P@60Hz	V	V

Screen Size	138,7 cm / 55"
LCD Panel	1920x1080
Refresh Rate	100Hz
Input Function	RF in x 1
	SCART x 2
	AV x 1
	Component Video RCA In x 1
	Component Audio In x 1
	HDMI x 4
	VGA x 1
	VGA Audio In x 1
	CI x 1
	S-Video x 1
Output Function	Earphone Out
	Speaker 15W+15W
Feature	Full HD
	HD Ready
	3D Combo Filter
	3D De Interlacer
	Noise Reduction
	3:2/2:2 Pull down
	X-Contrast (15000:1)
	24p input

Disassembling the stand base

- 1 Disconnect all the cables and cords from the TV to prevent breakage.
- 2 Carefully place the TV face down on a soft and flat surface (blanket, foam, cloth, etc) to prevent any damage to the TV.
- 3 Remove the six (6) screws so that the stand base can be removed.
- 4 Gently remove the stand base.

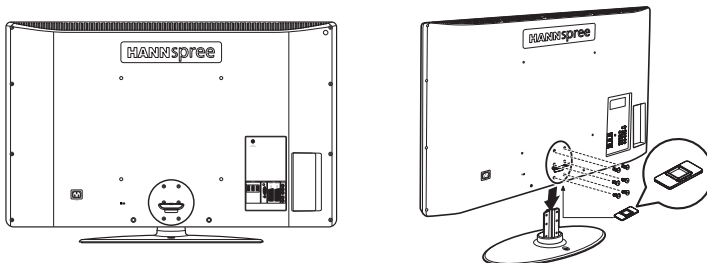

(For reference only)

Wall mounting the TV:

- 1 Purchase a VESA compatible wall bracket: VESA 400 X 400, 4 holes, M6, 20mm.
- 2 Locate your ideal TV position on the wall.
- 3 Fix the wall bracket firmly on the wall.
- 4 Secure the TV to the bracket using the 4 mount holes on the back and center of the TV.

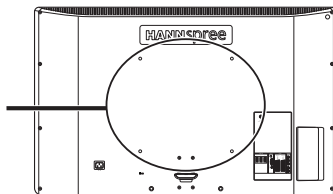

Note:

- Please read the instructions of your specific wall bracket to properly wall mount the TV.
- The pitch of the mounting holes is 400mm horizontally and 400mm vertically.
- The screws type required is metric: M6, 20 mm length.
- The 55" TV stand base can be screwed on a table or a hard surface using the hole on the back of the stand base. Nevertheless, it's recommended to mount your TV on the concrete wall.

**Installing the LCD TV requires special skill that should only be performed by qualified service personnel. Customers should not attempt to do the work themselves. please contact with Hannspree dealers in wall mount bracket. You can ask a qualified service personnel about using an optional bracket to mount the TV to the wall. Please add rubber cover when this TV is mounted on the wall.*

Equipment to be used with for open site.

Using the Cable Organizer

Route the cables through the cable clamp as shown:

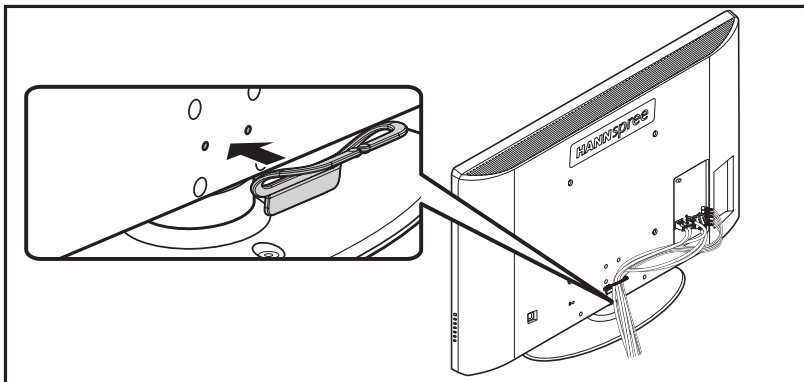

Free Manuals Download Website

<http://myh66.com>

<http://usermanuals.us>

<http://www.somanuals.com>

<http://www.4manuals.cc>

<http://www.manual-lib.com>

<http://www.404manual.com>

<http://www.luxmanual.com>

<http://aubethermostatmanual.com>

Golf course search by state

<http://golfingnear.com>

Email search by domain

<http://emailbydomain.com>

Auto manuals search

<http://auto.somanuals.com>

TV manuals search

<http://tv.somanuals.com>