

HANNspree

**HANNSPREE CALIFORNIA, INC.**

843 Auburn Court,  
Fremont, CA 94538, U.S.A.  
TEL: 1-510-360-3000  
FAX: 1-510-360-3001  
[www.hannspree.com](http://www.hannspree.com)

HANNspree

# 23" Liquid Crystal Display Television

User's Manual

**BBE.**

**SRS**   
**TruSurround**

**eala**

MAK-000004

# Table of Contents

1. Regulatory Information .....	3
2. Description of Warning Symbols .....	5
3. Safety Notices .....	6
4. Preface .....	13
5. Introducing the TV .....	15
Features .....	15
6. Checking Package Contents .....	16
7. Getting Started .....	17
Control Panel .....	17
Input and Output Jacks .....	18
Remote Control .....	20
Inserting the Remote Control Batteries .....	23
8. Making Connections .....	25
Connecting to an Antenna or Cable TV .....	25
Connecting to AV Devices .....	26
Connecting to a VCR/VCD/DVD player using component video .....	26
Connecting to a VCR/VCD/DVD player using S-Video .....	27
Connecting to a VCR/VCD/DVD player using composite video .....	28
Connecting to a Video Camera using S-Video .....	29
Connecting External Earphones .....	30
Connecting an Amplifier of Speakers .....	31
Connecting to a PC .....	32
Connecting the Power Adapter .....	33
Inserting a compact Flash Card (CF card) .....	34
9. Using the TV .....	35
Using the Remote Control .....	35
Turning the TV On and Off .....	35
Selecting Channels .....	35
Switching Source Signals .....	35
Adjusting the Volume .....	36
Using PIP and POP .....	36
Using the Flash card Feature .....	38
Starting Flash card .....	38
Remote Control Keys .....	39
Viewing Photos .....	40
Zooming and Panning .....	40
Rotating Images .....	41
Viewing a Slide Show .....	41
Listening to Music .....	42
Watching Videos .....	43
Viewing CF Card Files .....	43
Using the Setup Menu .....	44
Music Setup .....	44

# Table of Contents

Slide Show Setup .....	44
Movie Setup .....	45
Preferences .....	45
10. Adjusting On-Screen Display (OSD) Settings .....	46
OSD Setting Menu .....	46
Picture Setting .....	47
Brightness .....	48
Contrast .....	49
Hue .....	50
Saturation .....	51
Sharpness .....	52
Backlight (PC mode) .....	53
Black Level .....	54
Color Temperature .....	55
Preset .....	56
Audio Setting .....	57
Treble .....	58
Bass .....	59
Balance .....	60
BBE, TruSurround, and EALA .....	61
Earphone .....	62
Preset .....	63
TV Setting .....	64
TV/CATV .....	65
MTS .....	66
Auto Scan .....	67
Channel Add/Erase .....	68
Favorite Channel .....	69
PC Setting .....	70
DOS Mode .....	71
Miscellaneous Setting .....	72
Wide .....	73
Language .....	73
Sleeper .....	74
Time .....	75
C. Caption (Closed Caption) .....	76
Parental .....	77
11. Taking Care of Your TV & Remote Control .....	84
12. Troubleshooting .....	85
13. Warranty and Service .....	87
14. Specifications .....	88
PC Mode Support Timing .....	88
PIP Operation Mode .....	89
15. Glossary .....	90

### FCC Compliance Statement<sup>1</sup>

This device complies with part 15 of the FCC Rules. Operation is subject to the following two conditions: (1) This device may not cause harmful interference, and (2) this device must accept any interference received, including interference that may cause undesired operation.

### Additional Information

This equipment has been tested and found to comply with the limits for a Class B digital device, pursuant to part 15 of the FCC Rules. These limits are designed to provide reasonable protection against harmful interference in a residential installation. This equipment generates, uses and can radiate radio frequency energy and, if not installed and used in accordance with the instructions, may cause harmful interference to radio communications. However, there is no guarantee that interference will not occur in a particular installation. If this equipment does cause harmful interference to radio or television reception, which can be determined by turning the equipment off and on, the user is encouraged to try to correct the interference by one or more of the following measures:

- Reorient or relocate the receiving antenna
- Increase the separation between the equipment and receiver
- Connect the equipment into an outlet on a circuit different from that to which the receiver is connected
- Consult the dealer or an experienced radio/TV technician for help

**Warning:** You are cautioned that changes or modifications not expressly approved by the party responsible for compliance could void your authority to operate the equipment.

---

1. applies only to products purchased in the United States of America

---

## **DOC Compliance Notice<sup>1</sup>**

This digital apparatus does not exceed the Class B limits for radio noise emissions from digital apparatus as set out in the Radio Interference Regulations of the Canadian Department of Communications. This device complies with Canada ICES-003 Class B.

## **CE Conformity Statement<sup>2</sup>**

This device complies with the requirements set out in the Council Directive on the approximation of the Laws of the Member States relating to Electromagnetic Compatibility (89/336/EEC) and the Amendment Directive (92/31/EEC), Low-Voltage Directive (73/23/EEC) and the Amendment Directive (93/68/EEC).

- 
1. applies only to products purchased in Canada
  2. applies only to products purchased in the European Union

## Description of Warning Symbols



### Before You Proceed

1. Read all Safety Notices in Section 2 of this manual and instructions in the User's Manual carefully before either plugging in or turning the TV on.
2. Keep this User's Manual in a safe place for future reference. Keep the box and packaging in case the TV needs to be shipped in the future.
3. Follow the TV and warning label instructions.
4. Any uses, operations, changes, alterations or modifications of the TV that do not follow the instructions in this manual will void this TV's warranty.



**CAUTION**

RISK OF ELECTRIC SHOCK  
DO NOT OPEN



**WARNING**



This symbol is used to alert users to pay attention to important descriptions regarding usage, maintenance (repair), and additional important information related to this TV.

**CAUTION**



This symbol is used to alert users to the risk of electric shocks due to dangerous and uninsulated components.

### Electric Power Notice

Electric power may cause personal injury and mechanical damage if misused. Although safety has been taken into consideration during the design and production of this TV, electric shock or fire can result if the TV is misused. To prevent potential danger, read and follow the instructions and warnings contained in this manual when setting up, operating or cleaning the TV. In addition, please read all “Safety Notices” contained in this manual carefully before using the TV.



### Power Supply Safety Notes

1. To avoid electric shocks, do not use an extended power cord or an outlet that does not match this TV's plug or leaves the plug exposed.
2. This TV has a 3-pin grounded plug. The third pin connects to ground; do not remove it or alter it in anyway.
3. If the power cord or plug is damaged or worn, unplug it immediately and contact an authorized service technician for maintenance.
4. To avoid fire or electric shocks, do not overload electric power outlets.



## Installation Safety Notes

### Antenna

We suggest that you use an outdoor antenna to get the best signal possible unless you have cable TV or a centralized indoor antenna system. You may, however, use an antenna indoors if it is placed in a location free from interference.

### Location

Avoid prolonged exposure to sunlight or other strong sources of heat. Leave sufficient distance between the TV and the wall to provide enough space for the emission of heat.



## WARNING

To reduce the risk of fire or electric shock, do not expose this apparatus to rain or moisture.

Apparatus shall not be exposed to dripping or splashing and no objects filled with liquids, such as vases, shall be placed on the apparatus.



### Power

To avoid danger of fires or electric shock, only use the adapter listed below, which is compatible with this TV.

- LI SHIN INTERNATIONAL ENTERPRISE CORP.:  
LSE0226B20150



---

# IMPORTANT SAFETY INSTRUCTIONS

---



- 1 Read these instructions.
- 2 Keep these instructions.
- 3 Heed all warnings.
- 4 Follow all instructions.



- 5 Do not use this apparatus near water.



- 6 Clean only with dry cloth.



- 7 Do not block any ventilation openings. Install in accordance with manufacturer's instructions.



- 8 Do not install near any heat sources such as radiators, heat registers, stoves, or other apparatus (including amplifiers) that produce heat.

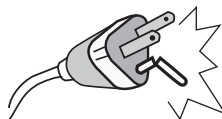

- 9 Do not defeat the safety purpose of the polarized or grounding-type plug. A polarized plug has two blades with one wider than the other. A grounding-type plug has two blades and a third grounding prong. The wide blade or the third prong are provided for your safety. If the provided plug does not fit into your outlet, consult an electrician for replacement of the obsolete outlet.



- 10 Protect the power cord from being walked on or pinched, particularly at plugs, convenience receptacles, and the point where they exit from the apparatus.



- 11 Only use attachments/accessories specified by the manufacturer.



- 12 Use only with the cart, stand, tripod, bracket, or table specified by the manufacturer, or sold with the apparatus. When a cart is used, use caution when moving the cart/apparatus combination to avoid injury from tip-over.



- 13 Unplug this apparatus during lightning storms or when unused for long periods of time.



- 14 Refer all servicing to qualified service personnel. Servicing is required when the apparatus has been damaged in any way, such as power-supply cord or plug is damaged, liquid has been spilled or objects have fallen into the apparatus, the apparatus has been exposed to rain or moisture, does not operate normally, or has been dropped.

---

## CAUTION



These servicing instructions are for use by qualified service personnel only. To reduce the risk of electric shock, do not perform any servicing other than that contained in the operating instructions unless you are qualified to do so.

---

## Personal Safety

---

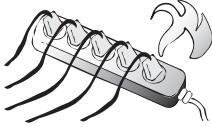

To avoid overloading the power supply, never plug too many electrical devices into an outlet, power strip, or extension cable.

---

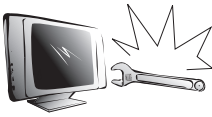

Dangerous high-voltage electric power components are located inside the TV. To avoid electric shock, do not disassemble the TV in any way.

---



Do not place or drop metals, small objects, or flammable materials into the vent of the TV.

---



If the TV is dropped, falls down, or is otherwise damaged, unplug the power cord immediately and contact an authorized service technician.

---



If any fluid is sprayed or dropped into the TV, contact an authorized service technician.

---



The screen of the TV is made of glass. Avoid hitting or scraping it. If the screen is broken, do not touch the broken glass.

---



Do not allow children to use the TV unattended.

---

---

## Installation

---

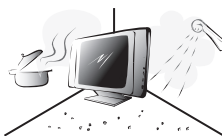

Do not place the TV in locations where there is excessive steam or dust.



Avoid blocking the TV's vents, do not place the TV on a bed, sofa, carpet, or in a sealed cabinet.

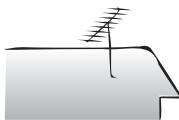

Install the outdoor antenna (not included) away from power transmission lines to avoid possible danger.



Unplug the power cord and antenna connector when there is a storm or when the TV is not in use for long periods to avoid electric shock from lightning.

---

## Operation

---



This TV is designed for home power sources as labeled on the casing. Avoid using any other power accessories to avoid electric shock or other damage.

---



The plug can be inserted into an outlet in only one direction as shown to the left. Do not alter the plug. Contact an authorized service technician if you cannot plug it in correctly.

---



If there is any problem that cannot be resolved according to the instructions given in this manual, contact an authorized service technician immediately. Do not attempt any methods not covered in this manual.

---

## Maintenance

---



Do not attempt to repair the TV by yourself. Contact an authorized service technician. Ask the service technician to complete a safety inspection before switching the power on after completing any maintenance.

---

Thank you for purchasing a Hannspree Liquid Crystal Display Television (LCD TV). Your new TV will allow you to enjoy superior audio and video while enriching your lifestyle with advanced technology.

Please carefully read this manual in its entirety before setting up, using or operating your TV. To ensure the safe and correct installation and operations of the TV, it is important that the safety and operation instructions in this manual are followed.

This instruction manual is designed to assist you in setting up and using the TV. The information in this manual has been carefully checked for accuracy; however, no guarantee is given to the correctness of the contents. The information in this manual is subject to change without notice.

To the extent allowed by applicable law, Hannspree California Inc. ("Hannspree") shall not be liable for direct, indirect, special, exemplary, incidental or consequential damages arising from any defect or omission in this manual, even if advised of the possibility of such damages in advance.

---

## Copyright

© Copyright 2004 Hannspree California Inc.

All rights reserved. This manual is protected by copyright and distributed under licenses restricting its use, copying and distribution. No part of this manual may be reproduced in any form by any means without the prior written authorization of Hannspree. The TV described in this manual may include copyrighted software of Hannspree (or other third parties). Hannspree (or other third parties) preserves the exclusive rights for copyrighted software, such as the right to distribute or reproduce the copyrighted software. Accordingly, and to the extent allowed by applicable law, any copyrighted software contained in the product described herein shall not be distributed, modified, reverse engineered, or reproduced in any manner without the prior written authorization of Hannspree (or of other third parties).

The Hannspree logos presented herein are trademarks of Hannspree. All other product names, trademarks or logos mentioned herein are used for identification purpose only, and may be the trademarks or registered trademarks of their respective owners.

The purchase of the product described herein shall not be deemed to grant, either directly or by implication, estoppel or otherwise, any license under the copyrights, patents, patent applications or trademarks of Hannspree, except for the normal, non-exclusive use that arises by operation of law in the sale of a product.

Thank you for purchasing this LCD TV. Your LCD TV is designed to be safe, versatile, and easy to use. The design makes it a fun addition to any room.

You can watch NTSC broadcast or cable television channels, and easily connect a VCR, VCD or DVD player to the standard CVBS and S-Video input ports located at the rear and/or side of the unit. You can also use the TV as a monitor for your PC by connecting it through the DVI port.

Convenient control buttons located on the TV and a handy remote control let you change channels, adjust the volume, and change display settings through an easy-to-use on-screen display menu system. The built-in stereo speakers provide full rich sound and a convenient audio output port lets you connect to an external audio system or earphones.

### Features

- Built-in TV tuner
- Audio/Video support:
  - Stereo audio inputs
  - Composite video inputs
  - Component video input
  - S-Video inputs
  - 3.5 mm stereo headphone output
  - DVI-D input
- On-Screen Display (OSD) menu system
- Multi-channel Television Sound (MTS) with SAP
- Built-in stereo speakers
- PIP/POP
- Image Enhancement Technology
  - 3:2 pull down
  - DCDi
  - 3D Comb Filter
- Noise Reduction
- Advanced de-interlacing
- Edge Enhancement
- Flash card Reader (selected models only)





## Checking Package Contents

---





Make sure the following components are included in the box. Please contact Hannspree Customer Service immediately if anything is missing or damaged.





- TV
- User's manual
- Quick start guide
- Warranty and service manual
- Power cord
- Power adapter
- Remote control and batteries
- Stop Card

## Control Panel

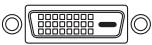

Description	Icon	Function
Power/ Power LED	 /  / <b>POWER</b>	Turns the TV on and off. Indicates power status.
Mute	<b>MUTE/ AUTO/MUTE</b>	In TV/AV mode, press this button to mute the audio. Press this button again to restore sound.
Source	<b>T/SOURCE</b>	Selects the input source to be displayed (TV/CATV, PC, AV1, AV2, AV3, AV4, or AV5).
Menu	<b>M/MENU</b>	Turns the On-Screen Display (OSD) menu on and off.
Select channel	<b>channel up ( ^ / ▲ ) channel down ( v / ▼ )</b>	Changes channels. Press channel up to increase the channel number. Press channel down to decrease the channel number. In PC or AV mode, press either button to return to TV mode.
Adjust volume	<b>volume up ( + / ▲ ) volume down ( - / ▼ )</b>	Press volume up to increase the audio volume. Press volume down to decrease the audio volume.
AV5- Flash card slot (selected models only)		Insert a CF card into this slot to view the contents of the CF card. Use the Flash card feature to view the contents. See "Using the Flash card Feature" on page 38.



## Input and Output Jacks



Description	Connector	Function
AV1 (R/L/PR/PB/Y)		Use the AV1 input to connect an external device, such as a VCR or a VCD/DVD player with a component output. <b>Audio Input (R/L):</b> red and white audio cables. <b>Video Input (PR/PB/Y):</b> video cables.
AV2 (R/L/V/S)		Use the AV2 input to connect an external device, such as a VCR or a VCD/DVD player. <b>Audio Input (R/L):</b> red and white audio cables. <b>Video Input (V or S):</b> yellow (video) or S-Video cable.
AV3 (R/L/V)		Use the AV3 input to connect an external device, such as a VCR or a VCD/DVD player with a composite output. <b>Audio Input (R/L):</b> red and white audio cables. <b>Video Input (V):</b> yellow (video) cable.
AV4 (V/L/R/S)		Use the AV4 input to connect an external device, such as a VCR or a VCD/DVD player. <b>Audio Input (L/R):</b> white and red audio cables. <b>Video Input (S-Video or Video):</b> S-Video cable or yellow (video).
ANT (Antenna/ Cable TV line in)		Connects to an antenna or CATV cable television line.

Description	Connector	Function
DC-IN		Connects to the included power adapter.
DVI-D		Connects to a PC's DVI port.
LINE IN		Connects to a PC's line/audio out port.
LINE OUT (R/L)		Connects to external stereo speakers.
Earphone line out jack		Connects to earphones.

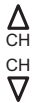
## Remote Control

Description	Icon	Function
Menu	MENU	Press this button to open up the setup menu of TV mode or flash card mode.
Arrow	▲ / ▼ / ◀ / ▶	Press ▲ / ▼ / ◀ and ▶ to scroll through the on-screen display menus. In flash card mode, use the arrow buttons to navigate menus, and to pan a picture when zooming in on a photo in Photo mode.
Number	1 2 3 4 5 6 7 8 9 0	Use to select a channel directly. Press 0-9 to enter the channel number (press 1 and 0 for channel 10).
Last	LAST	Press this button to return to the last channel selected.
CC/TTX	CC/TTX 	Press this button to enable the closed captions/subtitles (Only available in the United States of America). In flash card mode, use this button to rotate a picture when in Photo mode. This option may not be available in your local area.
Power		Turns the TV power on or off.
Adjust volume	+ VOL VOL -	Press volume up to increase the audio volume. Press volume down to decrease the audio volume.

Description	Icon	Function
Mute		Press this button to eliminate sound. Press mute again or press the volume adjust buttons to restore sound.
Select channel		Changes channels. Press channel up to increase the channel number. Press channel down to decrease the channel number. In PC or AV mode, press either button to return to TV mode.
Sound		Press this button to change the audio characteristics of the TV.
RGB	RGB	Press this button to switch to RGB mode (PC DVI-D input) or flash card mode.
Wide	WIDE	Press this button to switch between wide screen and other modes (4:3 – 16:9 – ANAMORPHIC).
Position	POSITION 	Press this button repeatedly to cycle through the PIP position options. In flash card mode, use this button to go to the next page in the menus.
Hold	HOLD ROOT	Press this button to hold or skip forward through tracks being played from the memory. In flash card mode, use this button to return to the flash card main screen.
PIP/POP	PIP/POP SLIDE	Press this button to use the PIP or POP functions. In flash card mode, use this button to start and stop the slide show.

Description	Icon	Function
Swap	SWAP 	Press this button to swap the PIP or POP pictures. In flash card mode, use this button to go to the previous page in the menus.
Favorite	FAV.	Press this button to select your favorite channels.
TV	TV	Press this button repeatedly to cycle through the TV reception options for the TV.
AV	AV	Press this button repeatedly to cycle through the AV-in options for the TV.
Return		Press this button to return to the last menu when using on screen display menus. In flash card mode, use this button to confirm a selection or activate a function.
Sleep		Press this button repeatedly to set the length of time until the TV turns off. Cancel the timer by pressing until the displayed time disappears. In flash card mode, use this button to zoom in on a picture when in Photo mode.
Display	DISP.	Press this button to show messages on the screen, such as the channel number, mode and others. Press this button again to close the displayed message.

**Note:**

**The four squares (red, green, yellow, and blue) have no function when the TV standard is set to NTSC.**

---

## Inserting the Remote Control Batteries

- 1 Open the battery compartment cover at the back of the remote control (A).

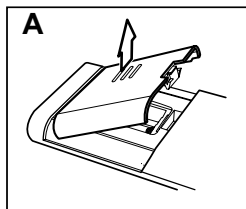

- 2 Insert the batteries paying attention to the polarity markings inside the battery compartment (B).

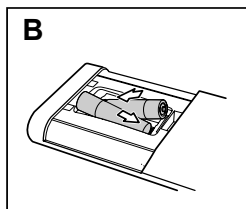

- 3 Replace the battery compartment cover (C).

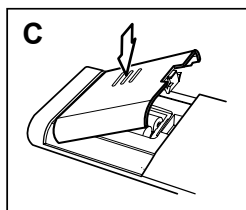



---

# CAUTION



- If the remote control is not used for a long period, remove the batteries and store them separately.
- Handle damaged or leaking batteries carefully, and wash hands after such handling.
- If your remote control has two batteries, do not mix new and old batteries because the life of the new batteries will be shortened. Chemical fluids may leak from the old batteries.
- Danger of explosion if battery is incorrectly replaced. Replace only with the same or equivalent type recommended by the equipment manufacturer. Discard used batteries according to manufacturer's instructions.
- Refer to your local recycling or waste disposal rules and contact a local waste disposal vendor to dispose of used batteries.
- The remote control may have a magnet in it, so do not place magnetic sensitive items such as watches, credit cards, or flash media close to the cover.
- Do not use force when pulling the remote control cover open; you may damage the hinge.

### Connecting to an Antenna or Cable TV

- 1 Connect one end of the VHF/UHF (Antenna) or CATV cable to ANT Jack (VHF/UHF IN Jack) on the back of the TV.
- 2 Connect the other end of the VHF/UHF (Antenna) or CATV cable to the antenna socket or CATV cable.

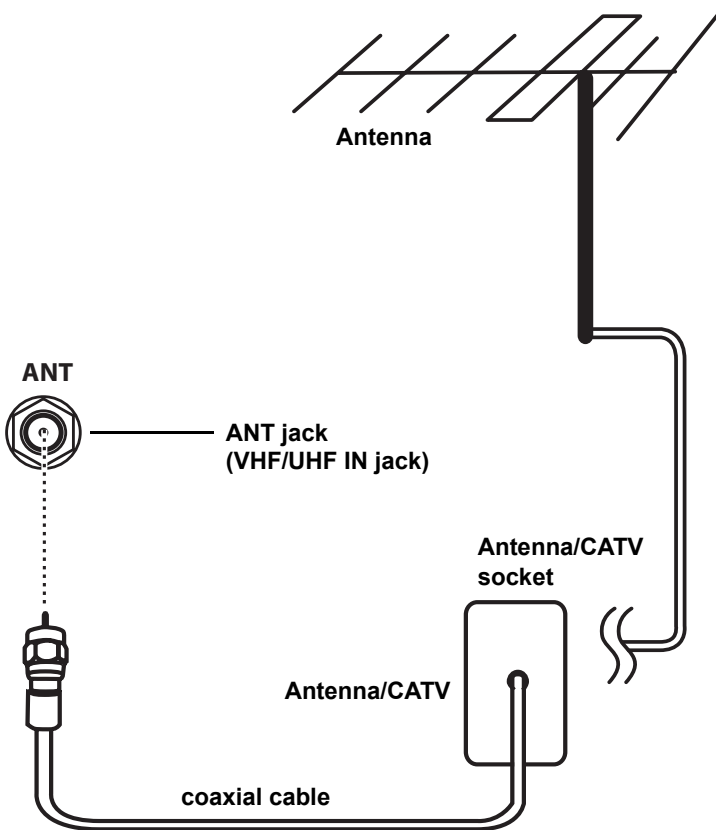

**Note:**

If you cannot receive channels after connecting to an antenna or cable TV line, try scanning for channels. See “Auto Scan” on page 67.

## Connecting to AV Devices

Connect external devices such as VCD / DVD players or VCRs to the TV using the AV1, AV2, AV3, and AV4 ports on the back or side of the TV.

### Connecting to a VCR/VCD/DVD player using component video

The illustration presented here shows how to connect your TV to a VCR / VCD / DVD player using the AV1 component video port. Actual connections may vary according to the make and model of your device. Refer to the user's manual included with the AV device for more detailed instructions.

**Note:**  
Location of the connectors depends on the TV model.

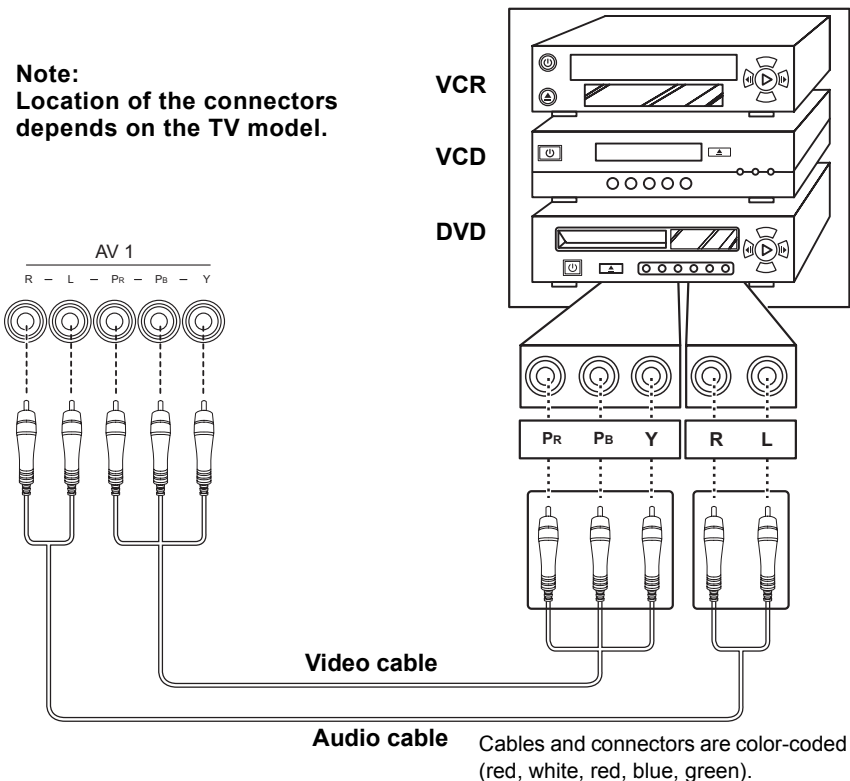

---

## Connecting to a VCR/VCD/DVD player using S-Video

The following illustration shows how to connect the TV to a VCR / VCD / DVD player using the AV2 S-Video port. Actual connections may vary according to the make and model of the device. Refer to the user's manual included with the camcorder for more detailed instructions.

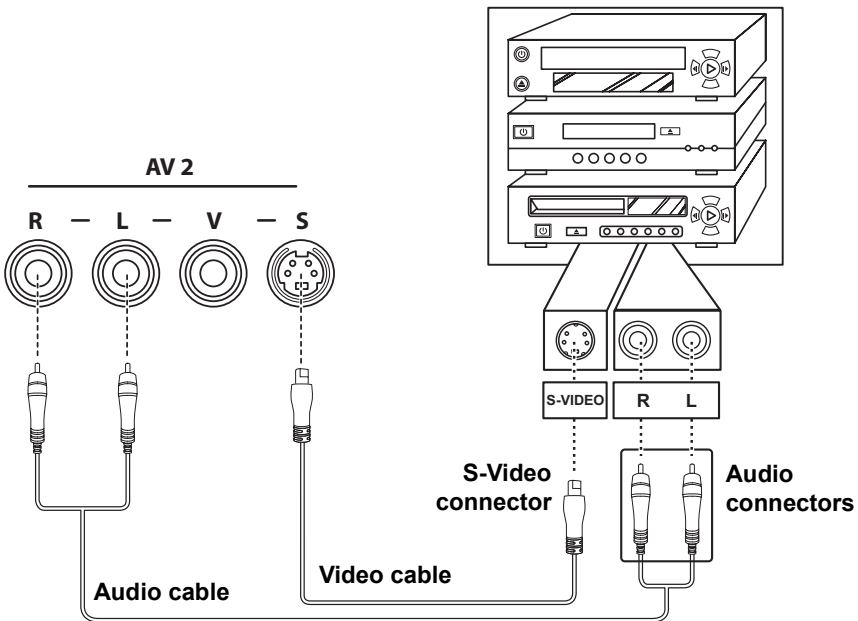

### Notes:

- **When connecting the S-Video connector and AV connectors at the same time, the priority is given to the S-Video connector.**
- **Location of the connectors depends on the TV model.**

Cables and connectors are color-coded (red, white, black).



---

## Connecting to a Video Camera using S-Video

The following illustration shows how to connect the TV to a camcorder using the AV4 S-Video port. Actual connections may vary according to the make and model of the device. Refer to the user's manual included with the camcorder for more detailed instructions.

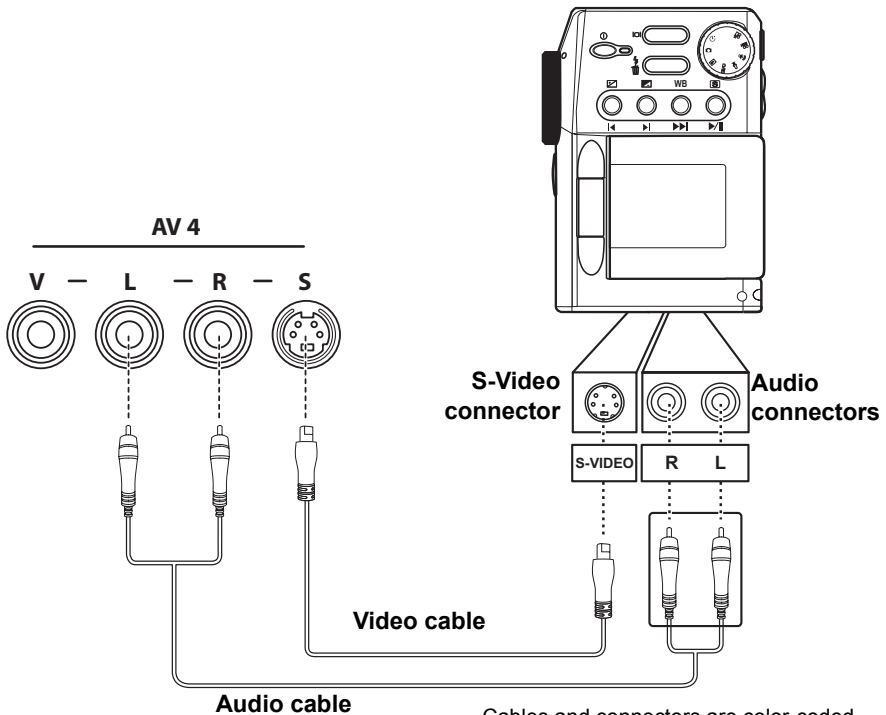

### Notes:

- **When connecting the S-Video connector and AV connectors at the same time, the priority is given to the S-Video connector.**
- **Location of the connectors depends on the TV model.**

Cables and connectors are color-coded (white, red, black).

---

## Connecting External Earphones

External earphones may be used to listen to the TV rather than using the built-in speakers. Connect external headphones to the earphone line out port as illustrated.

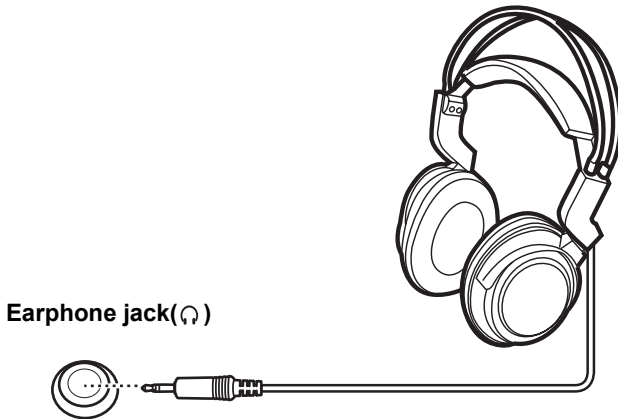

### Notes:

- External earphones are not included with the TV.
- The internal TV speakers still output sound when earphones are plugged in.
- The TV speakers function is to output the primary audio program. The earphones function is to output the secondary audio program.
- Location of the connectors depends on the TV model.

---

## Connecting an Amplifier of Speakers

Connect an external amplifier of speakers to the line out port to provide better sound quality. Refer to the following illustration.

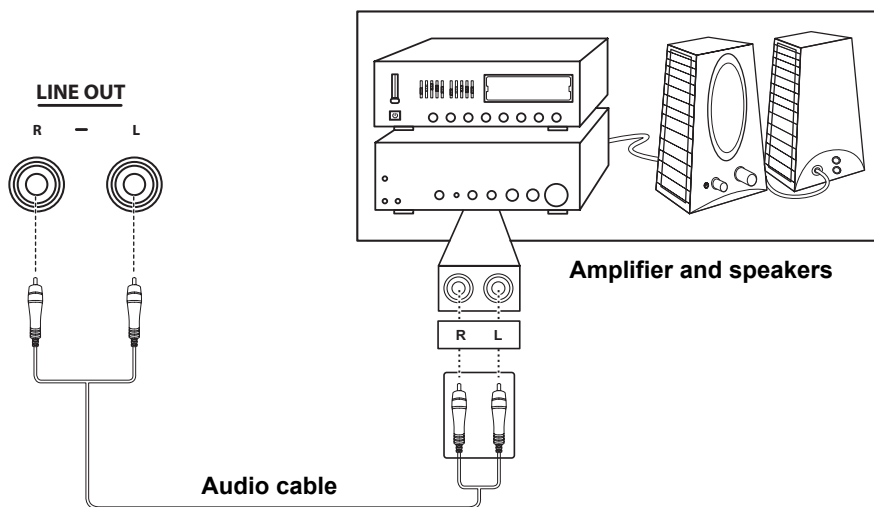

**Note:**  
Location of the connectors depends on the TV model.

Cables and connectors are color-coded (red, white).



---

## Connecting to a PC

Connect the TV to your PC to use it as the monitor using the DVI port as shown. Connect the DVI port of the TV to the DVI output of the PC. Connect the line out port of the PC to the line in port of your TV to listen to audio from the PC.

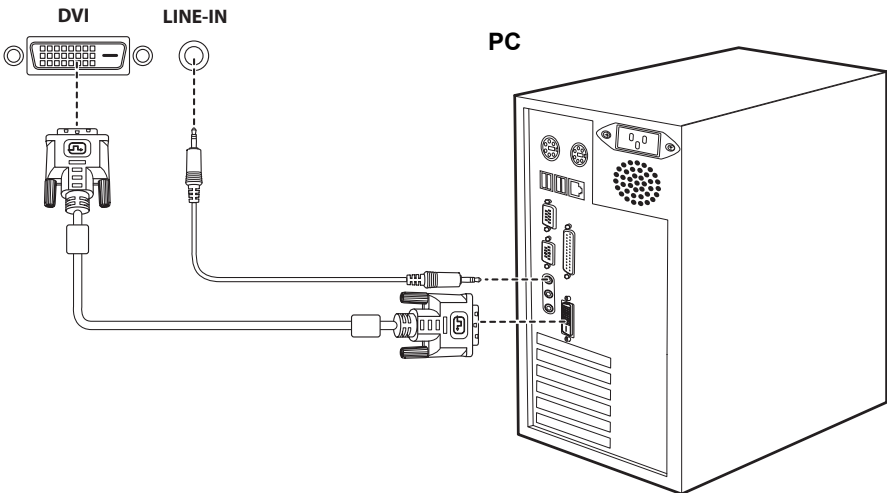

### Notes:

- You can connect the line out port of a CD-ROM player, stereo, or other device to the TV's line in port to listen to the devices audio output.
- When changing from TV mode to PC mode, the Power LED changes to amber, indicating that the PC is in sleep status.
- Location of the connectors depends on the TV model.

---

## Connecting the Power Adapter

- 1 Connect the power cord to the power adapter as illustrated.
- 2 Plug the power adapter connector into the DC-IN input jack on the rear panel of the TV.
- 3 Insert the three-pronged plug at the other end of the power cord into a power outlet.

**Note:**  
Location of the connectors depends on the TV model.

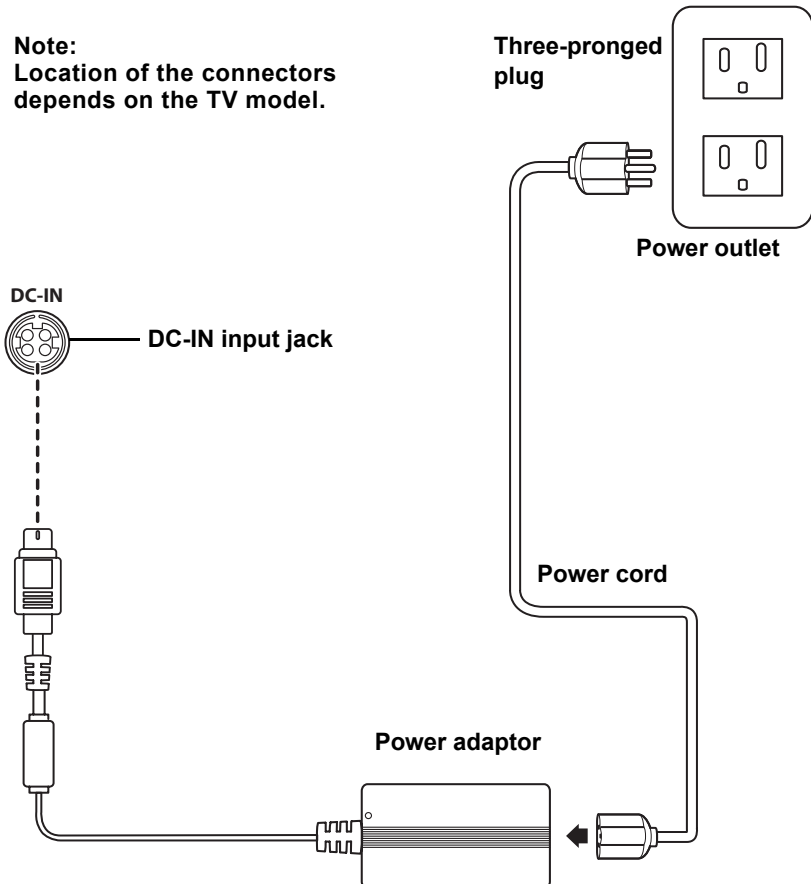

---

## Inserting a compact Flash Card (CF card)

- 1 Remove the card reader slot cover from the side of the TV.

**Note:**

**Step 1 depends on which TV model you purchase. If the TV's card reader slot does not have a cover, you can ignore step 1 and go straight to step 2.**

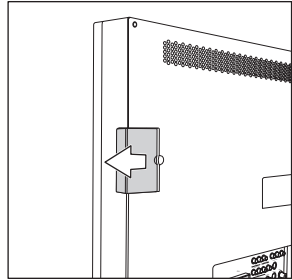

- 2 Insert the CF card in the direction of the arrow.

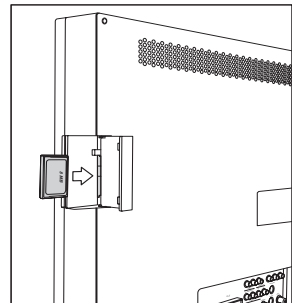

- 3 To remove the CF card, press the button. The CF card pops out. Gently slide out the CF card.

**Note:**

**Selected models only.**

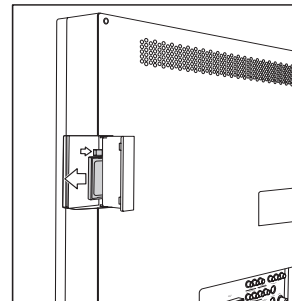

### Using the Remote Control

For best results, use the remote control within a distance of 20 feet (6 meters) from the front of the TV. Do not exceed an angle of 30 degrees when pointing at the TV.

#### Notes

- The operational distance may be shortened when the signal sensor is directly exposed to strong light.
- Aim the transmitter on the remote control at the signal sensor and ensure that there are no obstacles between them.

### Turning the TV On and Off

- 1 Press power on the remote control or on the control panel. The power LED indicator on the front of the TV changes from red to green, indicating that the power is on.
- 2 Press power again. The power LED changes from green to red, indicating that the TV is off.

### Selecting Channels

- 1 Press channel up to increase the channel number by one.
- 2 Press channel down to decrease the channel number by one.
- 3 Enter the specific channel number by pressing the number buttons on the remote control. The channel number is displayed on the screen.

### Switching Source Signals

Press source on the control panel repeatedly to select different sources. Alternatively, press TV on the remote control to select the TV/CATV source, press RGB to select the PC source, and press AV repeatedly to cycle through AV1-AV5 sources.

The selected source – TV/CATV, PC, AV1, AV2, AV3, AV4 and AV5 – appear on the top left corner of the screen in that order.

---

### Notes:

- The TV supports S-Video input in addition to normal video and audio signals. The TV detects the signal type automatically and gives priority to S-Video when two signals are detected at the same time.
- AV5 appears on selected models only.

## Adjusting the Volume

- 1 Press volume up to increase the volume.
- 2 Press volume down to decrease the volume.
- 3 Press mute to eliminate sound. The word "MUTE" appears on the bottom right corner of the screen and sound is turned off.
- 4 Press mute again to restore the original volume.

## Using PIP and POP

The TV features Picture-in-Picture (PIP) and Picture-outside-Picture (POP), enabling you to view two sources at the same time. Follow these instructions.

- 1 Turn on the TV and select a source signal.



- 2 Press PIP/POP from the remote control.

A picture-in-picture window appears on the display, using the last selected source signal for the PIP.



### Note:

Refer to "PIP Operation Mode" on page 89 for information on which sources are compatible with each other in PIP and POP mode.

- 
- 3** Press SWAP from the remote control to switch the focus from the PIP to the main source. The PIP identification line disappears and the PIP window border disappears.



- 4** Press POSITION from the remote control to move the PIP window to one of the four corners of the screen as shown.

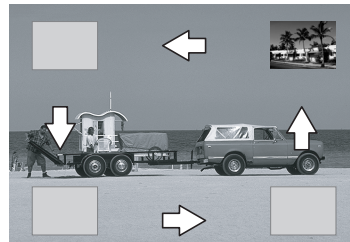

- 5** Press PIP/POP to switch to picture-outside-picture (POP) mode. The two signals are displayed side-by-side.



- 6** Press PIP/POP again. The screen displays the main source signal again.



---

## Using the Flash card Feature

The Flash card feature enables you to view photos, watch movies, and listen to MP3 files on CF cards inserted in the Flash card slot (AV 5). The following describes the Flash card feature.

### Starting Flash card

- 1 Insert a CF card into the CF card slot (AV 5). Refer to “Inserting a compact Flash Card (CF card)” on page 34.
- 2 Use the remote control arrow buttons to switch to AV5.

The Flash card main screen appears:

From this screen, you can choose to view photos, listen to music, watch videos, or look at the contents of the CF card.

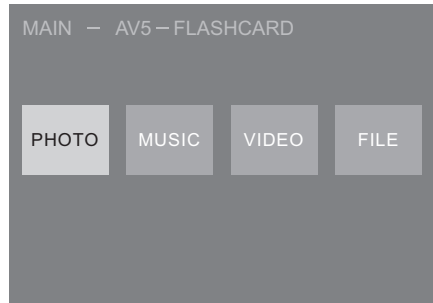

**Flash card main screen**

- 3 Use the remote control arrow buttons to select a file format, and press enter to open the file format page view.

#### Notes:

- Selected models only
- Flash card reader
  - Does not support Fast CF card
  - Currently the TV's Flash card reader only supports flash cards from PQI, HAGIWARA, SanDisk, TRANSCEND, and KINGSTON.



**Photo format page view**

---

## Remote Control Keys

The following table lists the remote control buttons used to operate the Flash card feature.

Button	Flash card Name	Function
Arrow (▲ / ▼ / ◀ / ▶)		Press these buttons to navigate the Flash card menus. In Photo mode, use these buttons to pan a picture when zooming in.
Return	Enter	Press this button to confirm a selection or to activate a function.
Menu	Menu	Press this button to open the setup menu.
Hold	Root	Press this button to return to the Flash card main screen.
PIP/POP	Slide Show	Press this button to start and stop the slide show.
Sleep	Zoom	Press this button to zoom in on a picture. Zoom ratios are available: 1X, 2X, 3X, 4X( Magnification will vary by input format).
CC/TTX	Rotate	Press this button to rotate a picture when in Photo mode.
Swap	Page Up	Press this button to go to the previous page in the menus.
Position	Page Down	Press this button to go to the next page in the menus.



---

## Viewing Photos

- 1 Use the remote control arrow buttons to select PHOTO.
- 2 Press enter.
- 3 A screen appears displaying thumbnails of images on the CF card.
- 4 Use the arrow buttons to select a thumbnail image.
- 5 Press enter.



- 6 The selected thumbnail expands to full screen mode.
- 7 Press ► or ▼ to go to the next picture. Press ◀ or ▲ to go to the previous picture.



### Zooming and Panning

The Flash card feature enables you to zoom in on images and pan the view. Follow these instructions.

- 1 Put an image in full screen mode as described in the previous section.
- 2 Press sleep on the remote control to zoom in on the image. Zoom ratios are available: 1X, 2X, 3X,4X(Magnification will vary by input format).
- 3 When zooming in on an image, press ► / ◀ / ▼ / ▲ on the remote control to pan the image.

---

## Rotating Images

Follow these instructions to rotate images when in Photo mode.

- 1** Put an image in full screen mode as described in the previous section.
- 2** Press CC/TTX on the remote control.
- 3** The image is rotated 90 degrees (90°) in a clockwise direction.

**Note:**

**You cannot rotate an image when the image is being zoomed.**

## Viewing a Slide Show

Flash card has a slide show feature that enables you to view your images.

- 1** Press PIP/POP to start the slide show.  
The files are viewed sequentially, and files in your music library are also played in sequence.
- 2** Press PIP/POP again to stop/pause the slide show.

**Note:**

**Refer to “Slide Show Setup” on page 44 to configure slide show settings such as interval time, repeat options, and transition effects.**

---

## Listening to Music

1 Use the remote control arrow buttons to select MUSIC.

2 Press enter.

A screen appears displaying a list of the music stored on your CF card.

3 Use the arrow buttons to select a music file. The selected file starts playing.

When the file finishes playing, the next file in the list is played.

4 Press enter to open the Music Equalizer screen. This screen enables you to view information about the file you are playing.

### Note

Refer to “Music Setup” on page 44 for information on changing the Repeat mode setting.

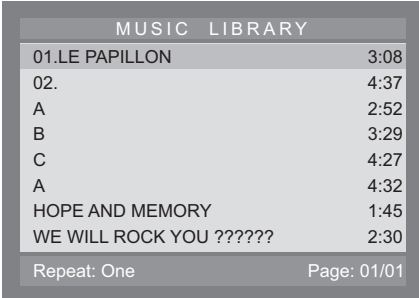

MUSIC LIBRARY	
01.LE PAPILLON	3:08
02.	4:37
A	2:52
B	3:29
C	4:27
A	4:32
HOPE AND MEMORY	1:45
WE WILL ROCK YOU ??????	2:30
Repeat: One Page: 01/01	

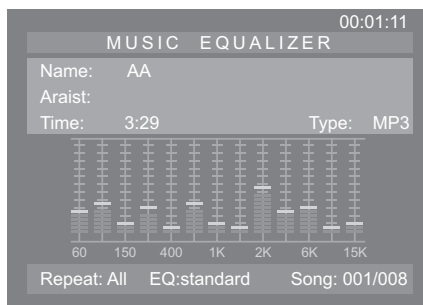

---

## Watching Videos

- 1 Use the remote control arrow buttons to select VIDEO.
- 2 Press enter.
- 3 A screen appears displaying thumbnails of the videos on your CF card.
- 4 Use the arrow buttons to select a video file.
- 5 Press enter. The selected video file begins playing.

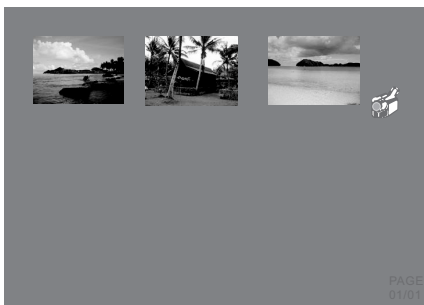

### Note:

Refer to “Movie Setup” on page 45 for information on setting Movie playback settings such as the interval time and repeat mode.

## Viewing CF Card Files

- 1 Use the remote control arrow buttons to select FILE.
- 2 Press enter.

A screen appears displaying a list of the files on your CF card. The file type is denoted by the icons, and the file size, creation date, and thumbnail view of the file provides additional information.
- 3 Use the arrow buttons to select a file and press Enter. The selected file is displayed or played.

---

## Using the Setup Menus

From the Flash card main screen, press menu to enter the SETUP MENU MAIN PAGE.

Use the arrow buttons to select a menu item and press enter to open the selected item. Select EXIT SETUP and press enter to leave the setup menu.

After making your selections in the submenus, use the arrow buttons to select MAIN PAGE and press enter to return to the SETUP MENU MAIN PAGE.

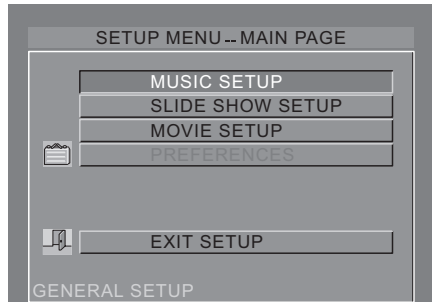

### Music Setup

- **Repeat Mode:** Use the arrow buttons to select REPEAT MODE. Repeat mode has the following options:
  - **ONE:** repeats one MP3 file
  - **ALL:** repeats all files in sequence
  - **OFF:** turns repeat mode off

### Slide Show Setup

- **Folder Repeat:** Use the arrow buttons to select FOLDER REPEAT. Folder Repeat mode has the following options:
  - **ON:** runs the slide show again in the selected folder.
  - **OFF:** turns the folder repeat mode off.
- **Interval Time:** Use the arrow buttons to select INTERVAL TIME. Set the interval time to 1, 3, 5, or 10 seconds.
- **Transition:** Use the arrow buttons to select TRANSITION and select a transition from the list.

---

## Movie Setup

Select MOVIE SETUP and press enter to display the movie setup menu.

- **Interval Time:** Use the arrow buttons to select INTERVAL TIME. Interval time mode has the following options:
  - **FAST:** sets an increased interval speed between playback.
  - **NORMAL:** sets the interval time to normal.
- **Repeat Mode:** Use the arrow buttons to select REPEAT MODE. Repeat mode has the following options:
  - **OFF:** turns the repeat mode off.
  - **ONE:** repeats playback of selected movie.
  - **ALL:** repeats playback of all movies in the folder.

## Preferences

Select PREFERENCES and press Enter to display the preferences menu.

- **TV Type:** Use the arrow buttons to select TV TYPE. TV type mode has the following options:
  - **MULTI.SYSTEM:** enables the system to automatically select the standard (either NTSC or PAL).
  - **NTSC:** sets the television standard to NTSC.
  - **PAL:** sets the television standard to PAL.
- **Video Output:** Use the arrow buttons to select VIDEO OUTPUT. Video output mode has the following option:
  - **S-VIDEO:** sets the video output to S-VIDEO.
- **Defaults:** Use the arrow buttons to select DEFAULTS. Select RESET and press enter to reset the Flash card settings to default values.

## Adjusting On-Screen Display (OSD) Settings

The On-Screen Display (OSD) menu system provides a quick and simple method to adjust your TV's setting. This chapter describes how to change each of the available settings. The OSD menu can be accessed through either the control panel or the remote control.

Function	Control Panel Icon	Button	Remote Control Icon
Menu	M/MENU	Menu	MENU
Channel up	∧ / ▲	Arrow up	▲
Channel down	∨ / ▼	Arrow down	▼
Enter	VOL(+ / - / ▲ / ▼)	Enter	◀ / ▶

The following sections explain how to adjust settings in the OSD menus using the remote control.

### OSD Setting Menu

Press menu to enter the OSD Main Menu screen.  
The Main Menu appears.

MAIN MENU  
 PICTURE  
 AUDIO  
 TV  
 MISCELLANEOUS  
 EXIT

⬆ : SELECT   ⬅ : ENTER   MENU : CLOSE

#### Notes:

- Press menu to open and close the OSD menu at any time.
- Alternatively, select the EXIT option in the menu to return to the previous menu.

---

## Picture Setting

Press menu to enter the OSD Main Menu screen.

- 1 Press ◀ or ▶ to enter the PICTURE Menu.



MAIN MENU  
PICTURE  
AUDIO  
TV  
MISCELLANEOUS  
EXIT

◄ : SELECT   ◀ : ENTER   MENU : CLOSE

### Notes:

- You can control the OSD with either the remote control or the control panel.
- PC picture mode and TV picture mode have different menu items; PC picture mode includes a Backlight adjustment.



---

## Brightness

Use the Brightness control to adjust the brightness of the screen image.

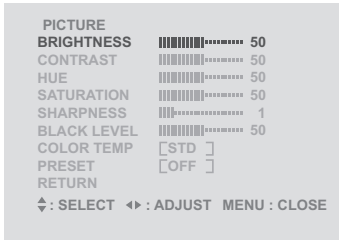

- 1 The slider bar shows the current setting.
- 2 Press ► to increase the brightness.
- 3 Press ◀ to decrease the brightness.

### Note:

The new setting is confirmed automatically when the OSD times out.

	MIN	MID	MAX
BRIGHTNESS	0	50	100

---

## Contrast

Use the Contrast control to adjust the contrast of the screen image.

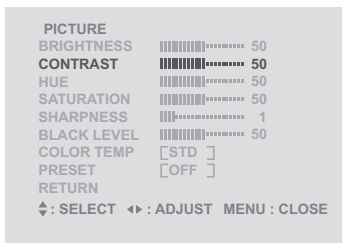

- 1 Press  $\blacktriangledown$  to select CONTRAST. The slider bar shows the current setting.
- 2 Press  $\blacktriangleright$  to increase the contrast.
- 3 Press  $\blacktriangleleft$  to decrease the contrast.

### Note:

The new setting is confirmed automatically when the OSD times out.

	MIN	MID	MAX
CONTRAST	0	50	100

---

## Hue

Use Hue to adjust the ratio of colors in the screen image.

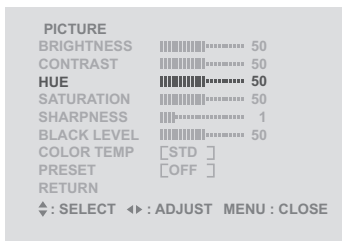

- 1 Press ▼ to select HUE. The slider bar shows the current setting.
- 2 Press ► to increase the hue.
- 3 Press ◀ to decrease the hue.

### Note:

The new setting is confirmed automatically when the OSD times out.

	MIN	MID	MAX
HUE	0	50	100

---

## Saturation

Use the Saturation control to adjust the density of the colors in the screen image.



- 1 Press ▼ to select SATURATION.  
The slider bar shows the current setting.
- 2 Press ► to increase the saturation.
- 3 Press ◀ to decrease the saturation.

### Note:

The new setting is confirmed automatically when the OSD times out.

	MIN	MID	MAX
SATURATION	0	50	100

---

## Sharpness

Use the Sharpness control to adjust the sharpness of the screen image.



- 1 Press ▼ to select SHARPNESS. The slider bar shows the current setting.
- 2 Press ► to increase the sharpness.
- 3 Press ◀ to decrease the sharpness.

### Note:

The new setting is confirmed automatically when the OSD times out.

	MIN	MID	MAX
SHARPNESS	0	1	7

---

## Backlight (PC mode)

Use the Backlight control to adjust the intensity of the screen backlight. This control is only for use in PC mode.

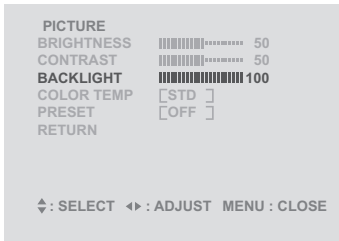

- 1 Press ▼ to select BACKLIGHT. The slider bar shows the current setting.
- 2 Press ► to increase the backlight intensity.
- 3 Press ◀ to decrease the backlight intensity.

### Note:

The new setting is confirmed automatically.

	MIN	MID	MAX
BACKLIGHT	0	50	100

---

## Black Level

Use the Black Level control to adjust the intensity of the black elements of the screen image.

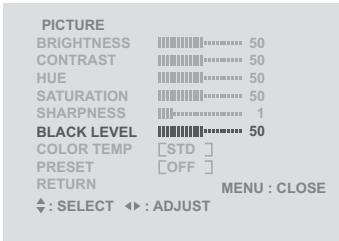

- 1 Press ▼ to select BLACK LEVEL. The slider bar shows the current setting.
- 2 Press ▶ to increase the black level.
- 3 Press ◀ to decrease the black level.

### Note:

The new setting is confirmed automatically when the OSD times out.

	MIN	MID	MAX
BLACK LEVEL	0	50	100

---

## Color Temperature

Use the Color Temperature control to adjust the color temperature of the screen image. A warm setting will result in an image with a predominantly red hue. A cold setting will result in a bluer image.



- 1 Press ▼ to select COLOR TEMP.
- 2 Press ◀ or ▶ to change the color temperature. The current setting is shown in brackets. The following options are available:
  - **STD Color** – for standard color settings.
  - **WARM Color** – for color settings with red as the dominant color.
  - **COLD Color** – for color settings with blue as the dominant color.

### Notes:

- The new setting is confirmed automatically when the OSD times out.
- The default color temperature is STD.



---

## Preset

Use the Preset function to reset all settings to factory defaults.

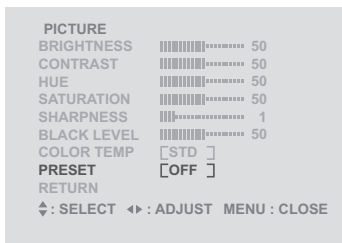

- 1 Press ▼ to select PRESET.
- 2 Press ◀ or ▶. "ON" appears in the brackets. All picture settings are returned to the factory-set default values.

**Note:**  
The preset function erases all of your custom picture settings.

---

## Audio Setting

Press menu to enter the OSD Main Menu screen.

- 1 Press ▼ to select AUDIO.
- 2 Press ◀ or ▶ to enter the AUDIO Menu.

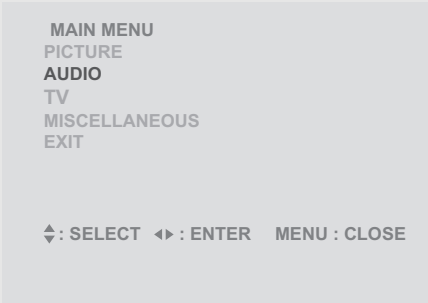

MAIN MENU  
PICTURE  
AUDIO  
TV  
MISCELLANEOUS  
EXIT

◆ : SELECT ◀▶ : ENTER MENU : CLOSE

### Note:

You can control the OSD with either the remote control or the control panel.

---

## Treble

Use the treble control to adjust the level of audio treble produced by the TV.

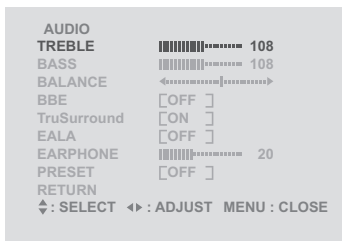

- 1 The slider bar shows the current setting.
- 2 Press **▶** to increase the treble.
- 3 Press **◀** to decrease the treble.

### Note:

The new setting is confirmed automatically when the OSD times out.

	MIN	MID	MAX
TREBLE	0	108	216

---

## Bass

Use the Bass control to adjust the level of audio bass produced by the TV.

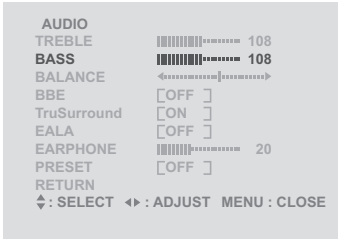

- 1 Press ▼ to select BASS. The slider bar shows the current setting.
- 2 Press ► to increase the bass.
- 3 Press ◀ to decrease the bass.

### Note:

The new setting is confirmed automatically when the OSD times out.

	MIN	MID	MAX
BASS	0	108	216

---

## Balance

Use the balance control to alter the audio balance between left and right speakers.

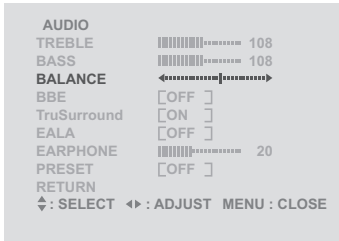

- 1 Press ▼ to select BALANCE. The slider bar shows the current setting.
- 2 Press ► to shift the balance to the right speaker.
- 3 Press ◀ to shift the balance to the left speaker.

**Note:**  
The new setting is confirmed automatically when the OSD times out.

---

## BBE, TruSurround, and EALA

Use the BBE, TruSurround, and EALA control to set the audio output characteristics for the TV.

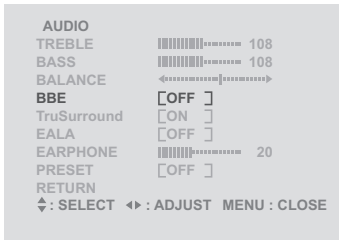

- 1 Press ▲ or ▼ to select BBE, TruSurround, or EALA.
- 2 Press ◀ or ▶ to select a setting for each effect:
  - BBE: OFF, HIGH, LOW
  - TruSurround: ON, OFF
  - EALA: OFF, ON

**Note:**  
Only one sound effect can be selected at a time.

---

## Earphone

Use the earphone control to set the earphone output volume.

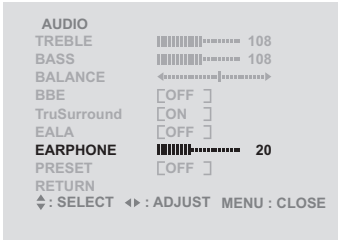

- 1 Press ▼ to select EARPHONE. The slider bar shows the current setting.
- 2 Press ► to increase the earphone volume.
- 3 Press ◀ to decrease the earphone volume.

### Note:

The new setting is confirmed automatically when the OSD times out.

	MIN	MID	MAX
EARPHONE	0	20	50

---

## Preset

Use the Preset function to reset all settings to factory defaults.

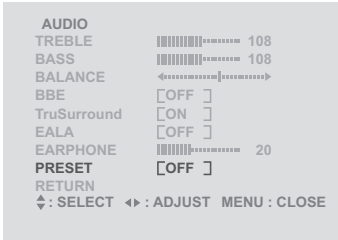

- 1 Press ▼ to select PRESET.
- 2 Press ◀ or ▶. “ON” appears in the brackets. All audio settings are returned to the factory-set default values.

**Note:**  
The preset function erases all of your custom audio settings.



---

## TV Setting

Press menu to enter the OSD  
Main Menu screen.

- 1 Press ▼ to select TV.
- 2 Press ◀ or ▶ to enter the TV Menu.

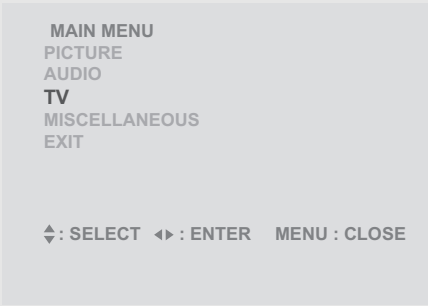

MAIN MENU  
PICTURE  
AUDIO  
**TV**  
MISCELLANEOUS  
EXIT

◀ : SELECT ▶ : ENTER MENU : CLOSE

### Notes:

- Operate the OSD with either the remote control or the control panel.
- The TV OSD menu is not available if the input source is not TV.

---

## TV/CATV

Use the TV/CATV setting to determine whether the TV receives cable TV signals or broadcast TV signals.

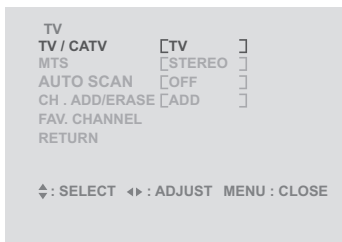

- 1** The current setting is shown in brackets.
- 2** Press ◀ or ▶ to select CATV in order to receive cable TV signals.
- 3** Press ◀ or ▶ to select TV in order to receive broadcast TV signals.

**Note:**  
The default TV setting is “TV”

---

## MTS

Use the MTS function to determine which audio channel is heard from speakers and earphones.

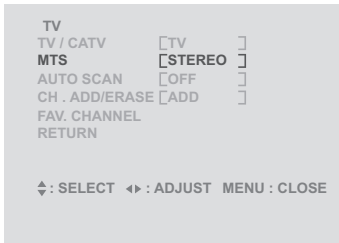

- 1 Press ▼ to select MTS. The current setting is shown in brackets.
- 2 Press ◀ or ▶ to select from the various MTS options:
  - **STEREO** – to select the main audio signal.
  - **SAP** – to select the secondary audio signal. This option may not be available in your local area.
  - **MONO** – to select MONO, which outputs sound through a single channel.
  - **DUAL** – to enable both primary and secondary audio signals. The primary signal is output through the speakers. The secondary signal is output through the earphones.
  - **EX. DUAL** – to exchange the primary and external secondary audio signals for speakers and earphones. i.e, the primary signal is output through the earphones and the secondary signal is output through the speaker.

**Note:**  
The TV screen displays the current channel that is successfully tuned after scanning is completed.

---

## Auto Scan

Use the Auto Scan function to scan for available channels.

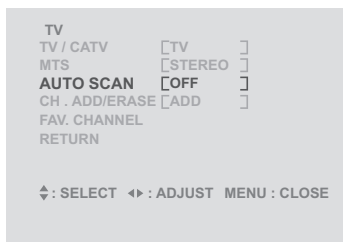

- 1 Press ▼ to select AUTO SCAN. The current setting is shown in brackets.
- 2 Press ◀ or ▶ to enable auto scanning. "ON" is displayed in brackets and the TV starts scanning automatically for TV channels.

**Note:**

The TV screen displays the current channel that is successfully tuned after scanning is completed.

---

## Channel Add/Eraser

Use the Channel Add/Eraser function to add or erase channels from the TV memory.

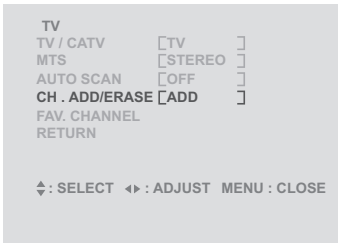

- 1 Press  $\blacktriangledown$  to select CH. ADD/ERASE. The current setting is shown in brackets.
- 2 Press  $\blacktriangleright$  to add the current channel.
- 3 Press  $\blacktriangleleft$  to delete the current channel.

### Note:

You can still access the erased channel by entering the channel number using the number buttons on the remote control. Add the channel again if it was erased accidentally.

---

## Favorite Channel

Use the Favorite Channel function to set favorite channels.

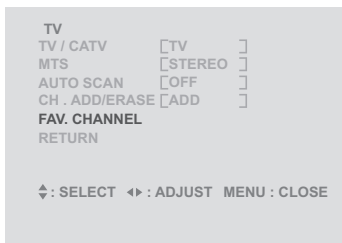

- 1 Press ▼ to select FAV. CHANNEL.
- 2 Press ◀ or ▶ to enter the FAV. CHANNEL menu.
- 3 Press ▲ or ▼ to set 4 favorite channels.
- 4 Press ◀ or ▶ to choose a channel to assign to the favorite channel number you selected in step 3.



**Note:**  
Assigning a channel to one of the four favorite channel numbers replaces a previously stored channel assignment.

---

## PC Setting

Press menu to enter the OSD  
Main Menu screen.

- 1 Press ▼ to select PC.
- 2 Press ◀ or ▶ to enter the PC Menu.



MAIN MENU  
PICTURE  
AUDIO  
**PC**  
MISCELLANEOUS  
EXIT

◆ : SELECT ◀▶ : ENTER MENU : CLOSE

### Notes:

- Operate the OSD with either the remote control or the control panel.
- The PC OSD menu is not available if the input source is not PC.

---

## DOS Mode

Use DOS mode to display computer text, but not graphics, on your TV screen.

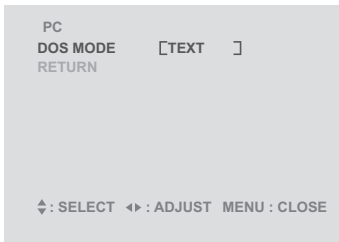

- 1** The current setting is shown in brackets.
- 2** Press ◀ or ▶ to toggle the setting between TEXT and GRAPHIC.
  - **TEXT** – select this option when using DOS at the command line.
  - **GRAPHIC** – select this option when using DOS based graphical programs.



---

## Miscellaneous Setting

Press menu to enter the OSD Main Menu screen.

- 1 Press ▼ to select MISCELLANEOUS.
- 2 Press ◀ or ▶ to enter the MISCELLANEOUS Menu.

```
MISCELLANEOUS
WIDE      [ 16 : 9 ]
LANGUAGE  [ ENGLISH ]
SLEEPER   [ OFF ]
TIME
C. CAPTION [ OFF ]
PARENTAL
RETURN
⬆ : SELECT ◀▶ : ADJUST MENU : CLOSE
```

### Note:

Operate the OSD with either the remote control or the control panel.

---

## Wide

Use the Wide control to set the aspect ratio of the screen.

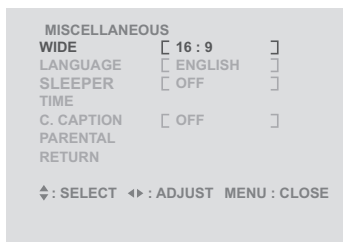

- 1 The current setting is shown in brackets.
- 2 Press ◀ or ▶ to select the screen format from the following:
  - 16:9
  - 4:3
  - ANAMORPHIC

## Language

Use the Language control to set the OSD display language.

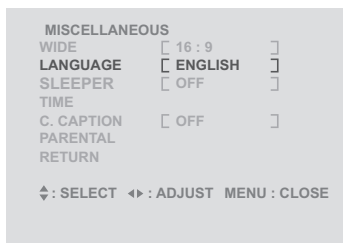

- 1 Press ▼ to select LANGUAGE. The current setting is shown in brackets.
- 2 Press ◀ or ▶ to select the language from the following:
  - ENGLISH
  - ESPAÑOL

**Note:**  
The default language setting is ENGLISH.

---

## Sleeper

The sleeper turns the TV off automatically after a set time.

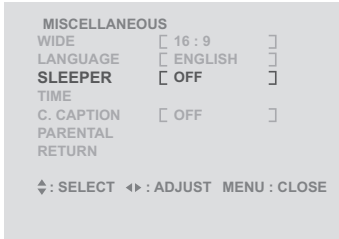

- 1 Press ▼ to select SLEEPER. The current setting is shown in brackets.
- 2 Press ◀ or ▶ to select a sleep timer value from the following:
  - OFF
  - 30
  - 60
  - 90
  - 120

You can also press **SLEEP** on the remote control to select OFF, 30, 60, 90 or 120 minutes. Press Display; the setting appears on the TV screen.

The remaining time is updated every 1 minute on the display.

---

## Time

This setting allows you to set the system time.

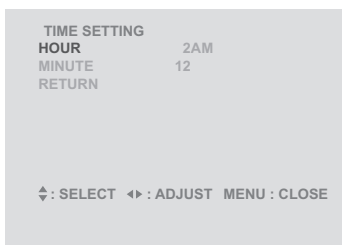
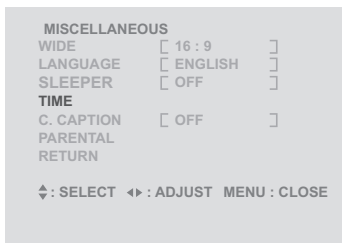

- 1 Press ▼ to select TIME.
- 2 Press ◀ or ▶ to enter the TIME menu.  
The TIME submenu appears.
- 3 Press ◀ or ▶ to increase or decrease the hour.
- 4 Press ▼ to select MINUTE. Press ◀ or ▶ to increase or decrease the minutes.

---

## C. Caption (Closed Caption)

This setting allows you to select closed caption subtitles or text information broadcast with the program<sup>1</sup>.

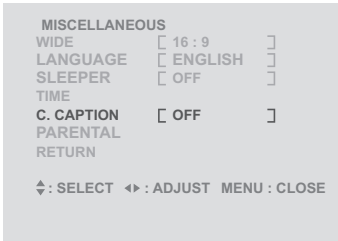

- 1 Press ▼ to select C.CAPTION.
- 2 Press ◀ or ▶ to select CC1, CC2, CC3, CC4, TEXT1, TEXT2, TEXT3, TEXT4, or OFF.
- 3 Press ▼ to select RETURN.
- 4 Press ◀ or ▶ to return to the MISCELLANEOUS menu.

**Note:**  
AV1 does not support C. CAPTION and PARENTAL functions. This option may not be available in your local area.

---

1. Closed Caption is only available in the United States of America.

---

## Parental

The Parental Control Function (V-CHIP) is used to block program viewing based on the ratings sent by the broadcast stations<sup>1</sup>. The United States has two rating systems for viewing contents, TV Parental Guidelines, and movie ratings. The TV Parental Guidelines work in conjunction with the V-CHIP to help parents screen out inappropriate television programs from their children. Movie ratings are used for original movies rated by the Motion Picture Association of America (MPAA) as watched on cable TV and not edited for television. The V-CHIP can also be set to block MPAA-rated movies.

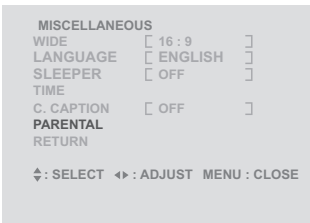

- 1 Press ▼ to select PARENTAL.
- 2 Enter the password number using the remote control keypad.
- 3 Press ▼ to select SUBMIT.
- 4 Press ◀ or ▶ to submit the password.  
The PARENTAL submenu appears.

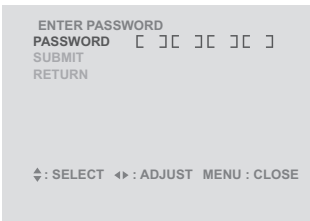

---

1. Parental functions are only available in the United States of America and is contingent upon the availability of the TV network programming.

---

V-CHIP  
V-CHIP [ON ]  
MPAA RATING  
TV RATING  
CHANGE PASSWORD  
RETURN

⇩ : SELECT ⇨ : ADJUST MENU : CLOSE

#### Note

To use parental control functions, a password must be entered. The default password is 0000. The password may only be entered using the remote control. If the wrong password is entered, “Wrong Password” is displayed. See “Change Password” on page 83.

---

## V-Chip

This setting allows you to turn the V-chip functions on or off.

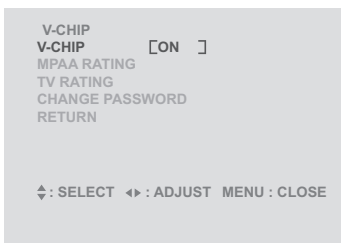

- 1** Press ◀ or ▶ to toggle the V-CHIP function ON or OFF.
- 2** Press ▼ to select RETURN.
- 3** Press ◀ or ▶ to return to the PARENTAL submenu.



---

## MPAA Rating

The MPAA rating menu allows you to block or unblock broadcast programs based on their movie rating.

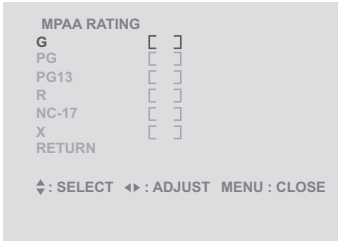

- 1 Press ▼ to select MPAA RATING.
- 2 Press ◀ or ▶ to display the MPAA RATING submenu.
- 3 Press ▼ to select a rating to change.
- 4 Press ▶ to block or ◀ to allow the selected rating.
- 5 Press ▼ to select RETURN.
- 6 Press ◀ or ▶ to return to the PARENTAL submenu.

**Note:**  
The setting automatically blocks any rating below your selection.

---

## TV Rating

The TV Rating menu allows you to block or unblock broadcast programs based on their TV rating.



- 1 Press ▼ to select TV RATING.
- 2 Press ◀ or ▶ to display the TV RATING submenu.
- 3 Press ▼ to select a rating to change.
- 4 Press ▶ to block or ◀ to allow the selected rating. The Blocked Content menu will display.
- 5 Press ▼ to select RETURN.
- 6 Press ◀ or ▶ to return to the PARENTAL submenu.

**Note:**  
The setting automatically blocks any rating below your selection.

---

## Ratings

### MPAA Ratings

<b>G</b>	-	Suitable for a general audience, all children
<b>PG</b>	-	Parental guidance suggested
<b>PG-13</b>	-	Parental guidance for children under 13 suggested
<b>R</b>	-	Restricted viewing. Parental guidance suggested for children under 17
<b>NC-17</b>	-	No-one under 17 allowed to view
<b>X</b>	-	Adults only

### TV Ratings

#### Age based

<b>TV-Y</b>	-	Suitable for a general audience, all children
<b>TV-Y7</b>	-	Directed at children aged 7 and older
<b>TV-G</b>	-	General audience
<b>TV-PG</b>	-	Parental guidance suggested
<b>TV-14</b>	-	Parents strongly cautioned
<b>TV-MA</b>	-	Mature audience only

#### Content based

<b>FV</b>	-	Fantasy violence
<b>D</b>	-	Suggestive dialogue
<b>L</b>	-	Strong language
<b>S</b>	-	Sexual situations
<b>V</b>	-	Violence

### Note

More information about the ratings system can be found by visiting these web sites:

<http://www.mpa.org>

<http://www.tvguidelines.org>

---

## Change Password

The Change Password function enables you to change the password needed to access Parental Control features.

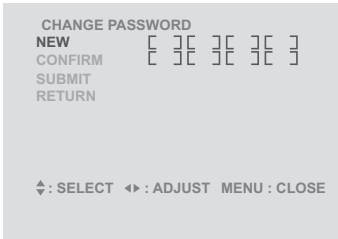

- 1 Press ▼ to select CHANGE PASSWORD.
- 2 Press ◀ or ▶ to display the CHANGE PASSWORD screen.
- 3 Enter the new password using the keypad on the remote control.
- 4 Press ▼ to select CONFIRM.
- 5 Enter the new password using the keypad on the remote control again to confirm.
- 6 Press ▼ to select SUBMIT.
- 7 Press ◀ or ▶ to submit the new password.
- 8 Press ▼ to select RETURN.
- 9 Press ◀ or ▶ to return to the PARENTAL submenu.

### Notes

- If the two passwords entered do not match, the message “Wrong Password” is displayed.
- Your password is required to access any parental control feature in the future. If you forget your password, refer to “Troubleshooting” on page 86.

# 11

## Taking Care of Your TV & Remote Control

---



Turn the power off before you begin cleaning the TV.



For best results, use a clean lens cloth to remove dust and fingerprints from the screen.



Do not wipe the shell of the TV with alcohol, methanol, gasoline or oil products to avoid damaging the finish. Wipe the shell with a dry soft cloth and use neutral cleaning fluids.

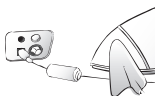

If your model has leather components, wipe the leather parts with a dry cloth and keep the area dry. Place the TV far from sources of steam to avoid making the leather wet.



Be careful to disconnect the power plug correctly. Hold the plug. Do not attempt to disconnect the plug by pulling on the power cord.

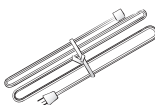

Arrange and store the power cord neatly as shown to the left to avoid knotting or bending which may cause fire due to damage or electric leakage.

### Note

**Protect the remote control from shock or vibration to avoid damage. Do not place the remote control in hot or humid locations.**

Situation	Solution
No picture and sound.	<ul style="list-style-type: none"> <li>• Connect the power cord properly.</li> <li>• Check if the power LED is on or not.</li> <li>• Press power on the control panel or remote control.</li> <li>• Press source to cycle through connected video sources.</li> <li>• Press channel up or channel down to switch to other TV stations.</li> <li>• Check the TV/CATV OSD settings. See "TV/CATV" on page 65.</li> <li>• Make sure all cables are connected properly.</li> </ul>
No picture, or poor picture, sound is OK.	<ul style="list-style-type: none"> <li>• Check the antenna and cable connections.</li> <li>• Adjust the brightness in the OSD menus. See "Brightness" on page 48.</li> </ul>
Picture is not in color.	<ul style="list-style-type: none"> <li>• Adjust the saturation in the OSD menus. See "Saturation" on page 51.</li> <li>• Make sure all cables are connected properly.</li> </ul>
Picture is OK, no sound.	<ul style="list-style-type: none"> <li>• Make sure the source device is functioning properly.</li> <li>• Make sure the audio cable is connected securely.</li> <li>• Turn the mute off.</li> <li>• Press volume up on the control panel or remote control.</li> <li>• Make sure the MTS option is set to STEREO, SAP, DUAL, or EX. DUAL. See "MTS" on page 66.</li> </ul>
One of the speakers has no sound.	<ul style="list-style-type: none"> <li>• Adjust the balance in the OSD menus. See "Balance" on page 60.</li> <li>• Make sure the audio cable is connected securely.</li> </ul>
Cannot receive some TV channels using cable TV.	<ul style="list-style-type: none"> <li>• Try the Auto Program function in the OSD "TV Setting" menu. See "Auto Scan" on page 67.</li> </ul>

Situation	Solution
Want to reset TV settings.	<ul style="list-style-type: none"> <li>• Use the Reset function in the OSD menu. See "Taking Care of Your TV &amp; Remote Control" on page 84.</li> </ul>
Cannot operate menus.	<ul style="list-style-type: none"> <li>• If OSD items are colored in light blue, the system is in a state such that those settings are not available.</li> </ul>
Forgot parental control password.	<ul style="list-style-type: none"> <li>• Use the master password 0928</li> </ul>
Screen image turns over.	<ul style="list-style-type: none"> <li>• Make sure the video signal cable is connected properly.</li> </ul>
Snow appears on the screen.	<ul style="list-style-type: none"> <li>• Adjust the location of the antenna, placing it far from roads or sources of interference.</li> <li>• Check the antenna and the video signal line connections.</li> </ul>
Blurred or overlapped images.	<ul style="list-style-type: none"> <li>• Readjust the sharpness setting.</li> <li>• Choose programs with high quality signals.</li> <li>• Adjust the direction of the antenna or change the video signal cable.</li> </ul>
Remote control doesn't work.	<ul style="list-style-type: none"> <li>• Make sure the battery is inserted correctly.</li> <li>• Replace the battery with a new one.</li> <li>• Make sure the TV power cord is plugged in.</li> <li>• Make sure the path between the remote control and the sensor is clear.</li> <li>• Try operating the remote control at a closer distance to the TV. Refer to "Using the Remote Control" on page 35.</li> </ul>

For complete warranty service information, please refer to the “Warranty and Service Manual” enclosed with your TV.



## 23-inch LCD TV

LCD Panel Size	23-inch TFT
Aspect Ratio	15:9
Best Resolution	1280 (horizontal) x 768 (vertical)
TV System	NTSC
Video System	AV1: Component Video (Audio in (R/L), YPBPR) AV2: Composite Video (RCA jack; + S-Video) AV3: Composite Video (RCA jack) AV4: Composite Video (RCA jack; + S-Video) AV5: Flash card reader (selected models only)
Audio System	AV1, AV2, AV3, AV4: L/R RCA jacks (audio input) 8 mm line in jack (audio input) 3.5 mm earphone and L/R line out RCA jacks (audio output)
Built-in Stereo Speakers Amplifier	7.5W + 7.5W
Power Supply	100-240V, 50/60 Hz, 20V DC
Power Consumption	<150 W Maximum
Component Format	480i, 480p, 576i, 576p, 720p, 1080i

## PC Mode Support Timing

	Pixel Format	Hor. Freq. (kHz)	Hor. Polarity	Ver. Freq. (Hz)	Vertical Polarity	Standard
1	640*400	31.47	-	70	+	DOS_Graphic
2	720*400	31.47	-	70	+	DOS_Text
3	640*480	31.47	-	60	-	VESA
4	640*480	37.861	-	72	-	VESA
5	640*480	37.5	-	75	-	VESA
6	800*600	35.156	+	56	+	VESA
7	800*600	37.879	+	60	+	VESA
8	800*600	48.077	+	72	+	VESA
9	800*600	46.875	+	75	+	VESA
10	1024*768	48.363	-	60	-	VESA
11	1024*768	56.476	-	70	-	VESA
12	1024*768	60.023	+	75	+	VESA
13	832*624	49.7	-	75	-	MAC
14	1024*768	60.2	-	75	-	MAC
15	640*480	35	-	67	-	MAC

## PIP Operation Mode

The following table shows which main sources are compatible with PIP and POP sources.

Main Source	PIP Source	POP Source
AV1 (YPbPr or YCbCr)	AV2	—
	AV3	—
	AV4	—
	TV2	—
AV2 (S or CVBS)	AV2	AV2
	AV3	AV3
	AV4	AV4
	TV2	TV2
AV3(CVBS)	AV2	AV2
	AV3	AV3
	AV4	AV4
	TV2	TV2
AV4 (S or CVBS) "Front"	AV2	AV2
	AV3	AV3
	AV4	AV4
	TV2	TV2
TV	AV2	AV2
	AV3	AV3
	AV4	AV4
	TV2	TV2
PC	AV2	AV2
	AV3	AV3
	AV4	AV4
	TV2	TV2

**Aspect Ratio:** The ratio of width to height of a film, image or display screen.

**BBE:** A proprietary audio enhancement technology. BBE compensates for distortion common to loudspeakers.

**Broadcast TV:** Broadcasting video signals using high-frequency electromagnetic waves to distribute television channels to viewers (standard TV broadcast).

**CATV:** Community Antenna Television, the original name for cable TV. A television distribution system that uses coaxial cable instead of the traditional radio broadcasting (over-the-air) method to deliver television, FM radio, and other services to consumers.

**Color Temperature:** Adjusting the color temperature enables you to set the intensity of white light. Color temperature is measured in Kelvin (K). Higher color temperatures result in a blue tint. Lower temperatures result in a red tint.

**EALA:** 3D surround sound enhancement technology that provides a more immersive and realistic soundscape.

**Hue:** Colors in a color system are measured by hue, saturation and luminance. Hue indicates the predominant color.

**LCD (Liquid Crystal Display):** A display technology that uses rod-shaped molecules (liquid crystals) that flow like liquid and bend light.

**MTS:** Multi-channel Television Sound. Enables reception of audio other than the primary (MAIN) audio signal. DUAL enables reception of a stereo audio signal, while SAP (Second Audio Program) enables reception of a separate channel that may be a different language or completely different information such as the news.

**OSD (On-Screen Display):** A control panel on the television screen that allows you to select viewing options.

---

**Saturation:** Chromatic purity indicating the amount of white contained in a color. Fully saturated colors are pure colors; less saturated colors appear as pastel shades.

**Stereo:** is the default audio signal belonging to a particular channel.

**S-Video:** Separate video, a video cabling standard used to transmit video by keeping brightness (Y) and color information (C) on separate channels. Most often used with camcorders.

**TruSurround:** 3D audio surround technology that delivers virtual surround sound experience through any two speaker system, including internal television speakers and headphones.

**VCD:** A compact disk format developed in 1993 by Sony and Philips to capture full-motion video. A standard Video CD can hold 74 minutes of near VHS-quality video and CD-quality sound.

## **BBE, SRS, EALA Statement**

**BBE**®

- Manufactured under license from BBE Sound, Inc.
- Licensed by BBE Sound, Inc. under USP4638258, 5510752 and 5736897.
- BBE and BBE symbol are registered trademarks of BBE Sound, Inc.
- BBE High Definition Sound restores clarity and presence for better speech intelligibility and musical realism.

**SRS** (●)®  
**TruSurround**

is a trademark of SRS Labs, Inc. TruSurround technology is incorporated under license from SRS Labs, Inc.

**eala**

EALA is a trademark of New Japan Radio Co., Ltd.



# MEMO

---

---

---

---

---

---

---

---

---

---

---

---

---

---

---

---

---

---

---

---

---

---

---

# MEMO

---

---

---

---

---

---

---

---

---

---

---

---

---

---

---

---

---

---

---

---

---

---

---





## Free Manuals Download Website

<http://myh66.com>

<http://usermanuals.us>

<http://www.somanuals.com>

<http://www.4manuals.cc>

<http://www.manual-lib.com>

<http://www.404manual.com>

<http://www.luxmanual.com>

<http://aubethermostatmanual.com>

Golf course search by state

<http://golfingnear.com>

Email search by domain

<http://emailbydomain.com>

Auto manuals search

<http://auto.somanuals.com>

TV manuals search

<http://tv.somanuals.com>