

HANNspree

**HANNSPREE SHANGHAI, INC.**

Building 5, 1725, Yunbei Road, Nanxiang Town,  
Jiading, Shanghai, China 201802

TEL: 021-6917-5999

FAX: 021-6917-5858

[www.hannspree.com](http://www.hannspree.com)

HANNspree

**9.6"/12.1" Liquid Crystal Display  
Television**

User's Manual

MAK-000022

# Table of Contents

1. Regulatory Information .....	3
2. Description of Warning Symbols .....	5
3. Safety Notices .....	6
4. Preface .....	13
5. Introducing the TV .....	15
Features .....	15
6. Checking Package Contents .....	16
7. Getting Started .....	17
Control Panel .....	17
Input and Output Jacks .....	18
Remote Control .....	19
Inserting the Remote Control Battery/Batteries .....	21
8. Making Connections .....	23
Connecting to an Antenna or Cable TV .....	23
Connecting to AV Devices .....	24
Connecting to a VCR/VCD/DVD Player .....	24
Connecting to a Video Camera .....	25
Connecting to a Video Game Console .....	26
Connecting External Speakers or Headphones .....	27
Connecting the Power Adapter .....	28
9. Using the TV .....	29
Using the Remote Control .....	29
Turning the TV On and Off .....	29
Selecting Channels .....	29
Switching Source Signals .....	29
Adjusting the Volume .....	29
10. Adjusting On-Screen Display (OSD) Settings .....	30
TV & Remote Control Buttons .....	30
OSD Function Menu .....	31
Picture Setting .....	32
Video Mode .....	33
Color Temperature .....	34
Noise Reduction .....	34
Preset .....	35

# Table of Contents

Audio Setting .....	36
Equalizer .....	37
Balance .....	38
Surround .....	38
Preset .....	39
TV Setting .....	40
System .....	41
Channel Skip .....	42
Auto Program.....	43
Fine Tune .....	44
Favorite Channel.....	45
Customize Setting.....	46
Sleep Timer .....	47
OSD Timeout .....	47
Language .....	48
11.Taking Care of Your TV & Remote Control.....	49
12.Troubleshooting.....	50
13.Warranty and Service .....	52
14.Specifications .....	53
15.Glossary .....	54

## FCC Compliance Statement<sup>1</sup>

This device complies with part 15 of the FCC Rules. Operation is subject to the following two conditions: (1) This device may not cause harmful interference, and (2) this device must accept any interference received, including interference that may cause undesired operation.

## Additional Information

This equipment has been tested and found to comply with the limits for a Class B digital device, pursuant to part 15 of the FCC Rules. These limits are designed to provide reasonable protection against harmful interference in a residential installation. This equipment generates, uses and can radiate radio frequency energy and, if not installed and used in accordance with the instructions, may cause harmful interference to radio communications. However, there is no guarantee that interference will not occur in a particular installation. If this equipment does cause harmful interference to radio or television reception, which can be determined by turning the equipment off and on, the user is encouraged to try to correct the interference by one or more of the following measures:

- Reorient or relocate the receiving antenna
- Increase the separation between the equipment and receiver
- Connect the equipment into an outlet on a circuit different from that to which the receiver is connected
- Consult the dealer or an experienced radio/TV technician for help

**WARNING:** The Federal Communications Commission warns that changes or modifications of the TV not expressly approved by the party responsible for compliance could void your authority to operate the equipment.

---

1. applies only to products purchased in the United States of America

---

## **DOC Compliance Notice<sup>1</sup>**

This digital apparatus does not exceed the Class B limits for radio noise emissions from digital apparatus as set out in the Radio Interference Regulations of the Canadian Department of Communications. This device complies with Canada ICES-003 Class B.

## **CE Conformity Statement<sup>2</sup>**

This device complies with the requirements set out in the Council Directive on the approximation of the Laws of the Member States relating to Electromagnetic Compatibility (89/336/EEC) and the Amendment Directive (92/31/EEC), Low-Voltage Directive (73/23/EEC) and the Amendment Directive (93/68/EEC).

- 
1. applies only to products purchased in Canada
  2. applies only to products purchased in the European Union



### Before You Proceed

1. Read all Safety Notices in Section 3 of this manual and instructions in the User's Manual carefully before either plugging in or turning the TV on.
2. Keep this User's Manual in a safe place for future reference. Keep the box and packaging in case the TV needs to be shipped in the future.
3. Follow the TV and warning label instructions.
4. Any uses, operations, changes, alterations or modifications of the TV that do not follow the instructions in this manual will void this TV's warranty.



### CAUTION

RISK OF ELECTRIC SHOCK  
DO NOT OPEN



### WARNING



This symbol is used to alert users to pay attention to important descriptions regarding usage, maintenance (repair), and additional important information related to this TV.

### CAUTION



This symbol is used to alert users to the risk of electric shocks due to dangerous and uninsulated components.

**Electric Power Notice**

Electric power may cause personal injury and mechanical damage if misused. Although safety has been taken into consideration during the design and production of this TV, electric shock or fire can result if the TV is misused. To prevent potential danger, read and follow the instructions and warnings contained in this manual when setting up, operating or cleaning the TV. In addition, please read all “Safety Notices” contained in this manual carefully before using the TV.

**Power Supply Safety Notes**

1. To avoid electric shocks, do not use an extended power cord or an outlet that does not match this TV's plug or leaves the plug exposed.
2. This TV has a 3-pin grounded plug. The third pin connects to ground; do not remove it or alter it in anyway.
3. If the power cord or plug is damaged or worn, unplug it immediately and contact an authorized service technician for maintenance.
4. To avoid fire or electric shocks, do not overload electric power outlets.



## Installation Safety Notes

### Antenna

We suggest that you use an outdoor antenna to get the best signal possible unless you have cable TV or a centralized indoor antenna system. You may, however, use an antenna indoors if it is placed in a location free from interference.

### Location

Avoid prolonged exposure to sunlight or other strong sources of heat. Leave sufficient distance between the TV and the wall to provide enough space for the emission of heat.



## WARNING

To reduce the risk of fire or electric shock, do not expose this apparatus to rain or moisture.

Apparatus shall not be exposed to dripping or splashing and no objects filled with liquids, such as vases, shall be placed on the apparatus.



### Power

To avoid danger of fires or electric shock, only use those adapters listed below, which are compatible with this TV.

- EDAC POWER ELECTRONICS CO., LTD.: EA1050E-120
- LI SHIN INTERNATIONAL ENTERPRISE CORP.: 0217B1240



---

# IMPORTANT SAFETY INSTRUCTIONS

---



- 1 Read these instructions.
- 2 Keep these instructions.
- 3 Heed all warnings.
- 4 Follow all instructions.



- 5 Do not use this apparatus near water.



- 6 Clean only with dry cloth.



- 7 Do not block any ventilation openings. Install in accordance with manufacturer's instructions.



- 8 Do not install near any heat sources such as radiators, heat registers, stoves, or other apparatus (including amplifiers) that produce heat.

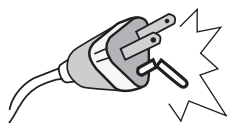

- 9 Do not defeat the safety purpose of the polarized or grounding-type plug. A polarized plug has two blades with one wider than the other. A grounding-type plug has two blades and a third grounding prong. The wide blade or the third prong are provided for your safety. If the provided plug does not fit into your outlet, consult an electrician for replacement of the obsolete outlet.

**Note:** Images are for illustration only and may vary by model or region.



- 10 Protect the power cord from being walked on or pinched, particularly at plugs, convenience receptacles, and the point where they exit from the apparatus.



- 11 Only use attachments/accessories specified by the manufacturer.



- 12 Use only with the cart, stand, tripod, bracket, or table specified by the manufacturer, or sold with the apparatus. When a cart is used, use caution when moving the cart/apparatus combination to avoid injury from tip-over.



- 13 Unplug this apparatus during lightning storms or when unused for long periods of time.



- 14 Refer all servicing to qualified service personnel. Servicing is required when the apparatus has been damaged in any way, such as power-supply cord or plug is damaged, liquid has been spilled or objects have fallen into the apparatus, the apparatus has been exposed to rain or moisture, does not operate normally, or has been dropped.

---

## CAUTION



These servicing instructions are for use by qualified service personnel only. To reduce the risk of electric shock, do not perform any servicing other than that contained in the operating instructions unless you are qualified to do so.

---

## Personal Safety

---

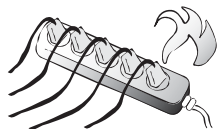

To avoid overloading the power supply, never plug too many electrical devices into an outlet, power strip, or extension cable.

---



Dangerous high-voltage electric power components are located inside the TV. To avoid electric shock, do not disassemble the TV in any way.

---



Do not place or drop metals, small objects, or flammable materials into the vent of the TV.

---



If the TV is dropped, falls down, or is otherwise damaged, unplug the power cord immediately and contact an authorized service technician.

---



If any fluid is sprayed or dropped into the TV, contact an authorized service technician.

---



The screen of the TV is made of glass. Avoid hitting or scraping it. If the screen is broken, do not touch the broken glass.

---



Do not allow children to use the TV unattended.

---

---

## Installation

---

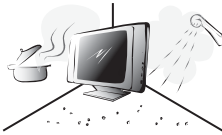

Do not place the TV in locations where there is excessive steam or dust.



Avoid blocking the TV's vents, do not place the TV on a bed, sofa, carpet, or in a sealed cabinet.

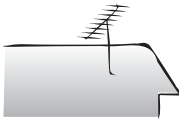

Install the outdoor antenna (not included) away from power transmission lines to avoid possible danger.



Unplug the power cord and antenna connector when there is a storm or when the TV is not in use for long periods to avoid electric shock from lightning.

---

## Operation

---



This TV is designed for home power sources as labeled on the casing. Avoid using any other power accessories to avoid electric shock or other damage.



The plug can be inserted into an outlet in only one direction as shown to the left. Do not alter the plug. Contact an authorized service technician if you cannot plug it in correctly.

**Note:** Images are for illustration only and may vary by model or region.



If there is any problem that cannot be resolved according to the instructions given in this manual, contact an authorized service technician immediately. Do not attempt any methods not covered in this manual.

---

## Maintenance

---



Do not attempt to repair the TV by yourself. Contact an authorized service technician. Ask the service technician to complete a safety inspection before switching the power on after completing any maintenance.

---

Thank you for purchasing a Hannspree Liquid Crystal Display Television (LCD TV). Your new TV will allow you to enjoy superior audio and video while enriching your lifestyle with advanced technology.

Please carefully read this manual in its entirety before setting up, using or operating your TV. To ensure the safe and correct installation and operations of the TV, it is important that the safety and operation instructions in this manual are followed.

This instruction manual is designed to assist you in setting up and using the TV. The information in this manual has been carefully checked for accuracy; however, no guarantee is given to the correctness of the contents. The information in this manual is subject to change without notice.

To the extent allowed by applicable law, Hannspree, Inc. ("Hannspree") shall not be liable for direct, indirect, special, exemplary, incidental or consequential damages arising from any defect or omission in this manual, even if advised of the possibility of such damages in advance.

---

## Copyright

© Copyright 2005 Hannspree, Inc.

All rights reserved. This manual is protected by copyright and distributed under licenses restricting its use, copying and distribution. No part of this manual may be reproduced in any form by any means without the prior written authorization of Hannspree. The TV described in this manual may include copyrighted software of Hannspree (or other third parties). Hannspree (or other third parties) preserves the exclusive rights for copyrighted software, such as the right to distribute or reproduce the copyrighted software. Accordingly, and to the extent allowed by applicable law, any copyrighted software contained in the product described herein shall not be distributed, modified, reverse engineered, or reproduced in any manner without the prior written authorization of Hannspree (or of other third parties).

The Hannspree logos presented herein are trademarks of Hannspree. All other product names, trademarks or logos mentioned herein are used for identification purpose only, and may be the trademarks or registered trademarks of their respective owners.

The purchase of the product described herein shall not be deemed to grant, either directly or by implication, estoppel or otherwise, any license under the copyrights, patents, patent applications or trademarks of Hannspree, except for the normal, non-exclusive use that arises by operation of law in the sale of a product.

Thank you for purchasing this LCD TV. Your LCD TV is designed to be safe, versatile, and easy to use. The design makes it a fun addition to any room.

You can watch broadcast or cable television channels, and easily connect a VCR, VCD, DVD player or a game device to the standard RCA and S-Video input jacks that are included in the 4-IN-1 A/V cable.

Convenient control buttons located on the TV and a handy remote control let you change channels, adjust the volume, and change display settings through an easy-to-use on-screen display menu system. The built-in stereo speakers provide full rich sound and a convenient audio output port lets you connect to an external audio system or headphones.

### Features

- Built-in TV tuner
- 4-IN-1 A/V cable
- On-Screen Display (OSD) menu system
- Built-in stereo speakers





## Checking Package Contents

---



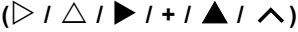
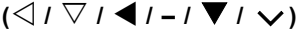

Make sure the following components are included in the box. Please contact Hannspree Customer Service immediately if anything is missing or damaged.

- TV
- User's manual
- Quick start guide
- Warranty and service manual
- Power cord
- Power adapter
- 4-IN-1 A/V cable
- Remote control and battery/batteries
- RCA jack x 3 (selected models only)
- Antenna cable (Hong Kong only)

## Control Panel

Description	Icon	Function
Power	 /POWER	Turns the TV on and off.
Power LED		Indicates power status.
Source	<b>SOURCE</b>	<p>Selects the input source to be displayed: (TV, AV1, AV2 or AV2s) / (TV, AV or AVs)</p> <p><b>Note:</b> If S-Video is connected, the TV autodetects it and AV and AV2 display as AVs and AV2s.</p>
Menu	<b>MENU</b>	Turns the On-Screen Display (OSD) menu on and off.
Select channel	<b>channel up</b> 	Changes channels. Press channel up to increase the channel number. Press channel down to decrease the channel number.
	<b>channel down</b> 	
Adjust volume	<b>volume up</b> 	Press volume up to increase the audio volume. Press volume down to decrease the audio volume.
	<b>volume down</b> 	

## Input and Output Jacks

Description	Connector	Function
4-IN-1 (AV / AV2)		Use the included 4-IN-1 A/V cable to connect external devices, such as a VCR, VCD, DVD player, CVBS RCA cables or a game device. <b>Audio Input:</b> AV connector audio (white and red) cables. <b>Video Input:</b> AV connector video (yellow) or S-Video cable.
R/L/VIDEO (AV1) (selected models only)		Use the AV1 input to connect an external device, such as a VCR, VCD, or DVD player. <b>Audio Input:</b> AV connector audio (white and red) cables. <b>Video Input:</b> AV connector video (yellow) cable.
ANT		Connects to an antenna or CATV cable television line.
DC-IN (DC-12V)		Connects to the included power adapter.
Headphone / Speakers jack		Connects to headphones or external speakers with built-in amplifier.

## Remote Control

Description	Icon	Function
Menu	MENU ENTER/MENU/M	Press this button to activate the OSD menu system and to adjust various settings and personal preferences.
Arrow	▲ / ▼ / ◀ / ▶ / < / >	Press ▲ / ▼ / ◀ and ▶ to scroll through the on-screen display menus. Favorite channels can be selected using the ◀ and ▶ buttons on the remote control.
Number	1 2 3 4 5 6 7 8 9 0	Use to select a channel directly. Press 0-9 to enter the channel number (press 1 and 0 for channel 10).
Recall/Last	RECALL / LAST	Press this button to return to the last channel selected.
MPX	MTS	Press this button to enable the bilingual function when the program has stereo/ I/II /MONO capabilities. This option may not be available in your local area.
Power		Turns the TV power on or off.
Adjust volume	-VOL VOL+ ▼VOL VOL▲	Press volume up to increase the audio volume. Press volume down to decrease the audio volume.
Mute	MUTE	Press this button to eliminate sound. Press mute again or press the volume adjust buttons to restore sound.

Description	Icon	Function
Select channel	▼CH CH▲ -CH CH+	Changes channels. Press channel up to increase the channel number. Press channel down to decrease the channel number. In AV mode, press either button to return to TV mode.
Source	SOURCE	Press this button to cycle the video input sources. The source is displayed on the screen.
Auto (selected models only)	AUTO	Press this button to automatically adjust the screen parameters in PC mode. Only available with 15-inch TVs.
Display (selected models only)	DISPLAY	Press this button to show messages on the screen, such as the channel number. Press this button again to close the displayed message.
Reset (selected models only)	RESET	Press this button to reset the TV.
Sleep (selected models only)	Sleep	Press this button repeatedly to set the TV timer (30, 60, 90, or 120 minutes). A timer appears on the top right corner of the screen to show the time remaining. Cancel the timer by pressing the button until the displayed time disappears.

---

## Inserting the Remote Control Battery/Batteries

- 1 Open the battery compartment cover at the back of the remote control (A).
- 2 **For AAA batteries:** Insert the batteries paying attention to the polarity markings inside the battery compartment (B).  
**For lithium batteries:** Insert the battery / batteries with the positive side (+) facing up (B). Remember to slide the battery / batteries underneath the metal contacts. Press downward to set the battery / batteries in place.
- 3 Replace the battery compartment cover (C) / (D).

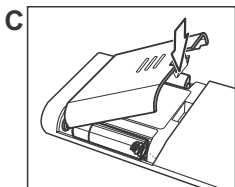
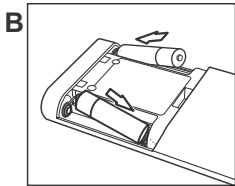
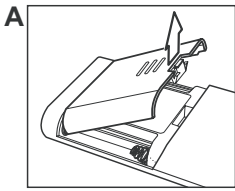

AAA batteries

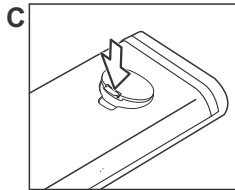
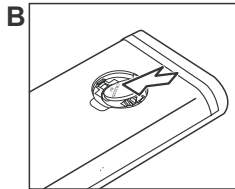
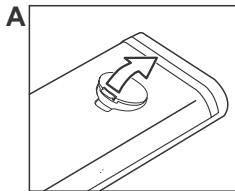

Lithium batteries 1

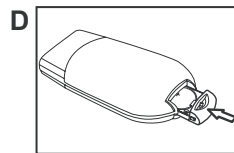
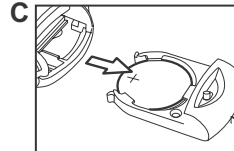
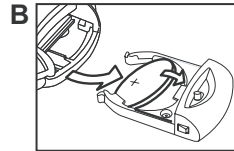
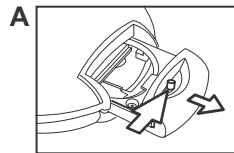

Lithium batteries 2

### Note

Your remote control may have either AAA type batteries or CR2022 / CR2025 lithium battery/batteries.

---

# CAUTION



- If the remote control is not used for a long period, remove the batteries and store them separately.
- Handle damaged or leaking batteries carefully, and wash hands after such handling.
- If your remote control has two batteries, do not mix new and old batteries because the life of the new batteries will be shortened. Chemical fluids may leak from the old batteries.
- Danger of explosion if battery is incorrectly replaced. Replace only with the same or equivalent type recommended by the equipment manufacturer. Discard used batteries according to manufacturer's instructions.
- Refer to your local recycling or waste disposal rules and contact a local waste disposal vendor to dispose of used batteries.
- The remote control may have a magnet in it, so do not place magnetic sensitive items such as watches, credit cards, or flash media close to the cover.
- Do not use force when pulling the remote control cover open; you may damage the hinge.

## Connecting to an Antenna or Cable TV

- 1 Connect one end of the VHF/UHF (Antenna) or CATV cable to ANT Jack (VHF/UHF IN Jack) on the back of the TV.
- 2 Connect the other end of the VHF/UHF (Antenna) or CATV cable to the antenna socket or CATV cable.

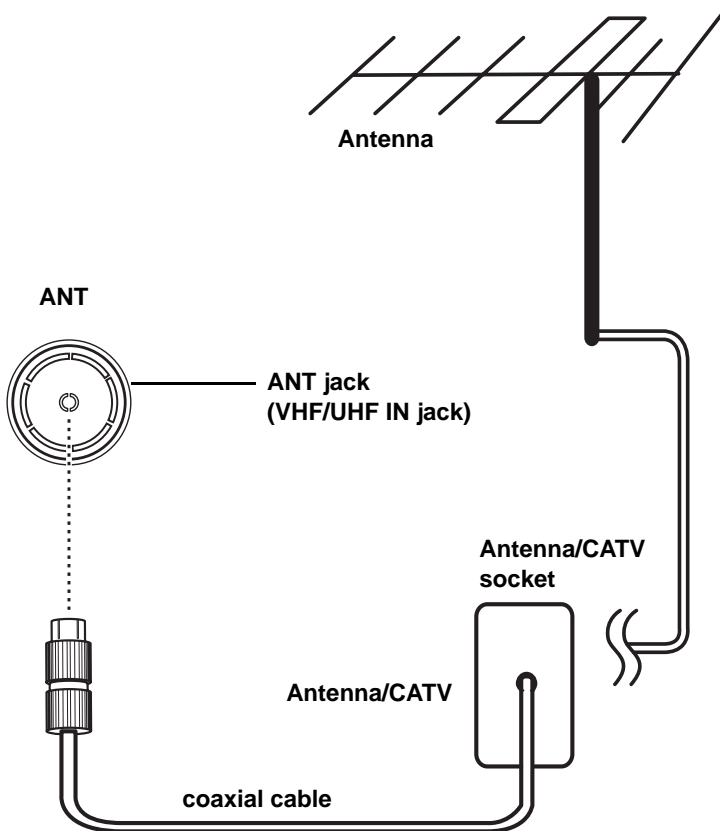

### Note

If you cannot receive channels after connecting to an antenna or cable TV line, try scanning for channels. See "Auto Program" on page 43.



---

## Connecting to AV Devices

Connect external devices such as a VCR, VCD, DVD player, or video game console to the TV using the supplied 4-IN-1 A/V cable.

### Connecting to a VCR/VCD/DVD Player

The illustration presented here shows how to connect the TV to a VCR, VCD or DVD player. Actual connections may vary according to the make and model of the device. Refer to the user's manual included with the device for more detailed instructions.

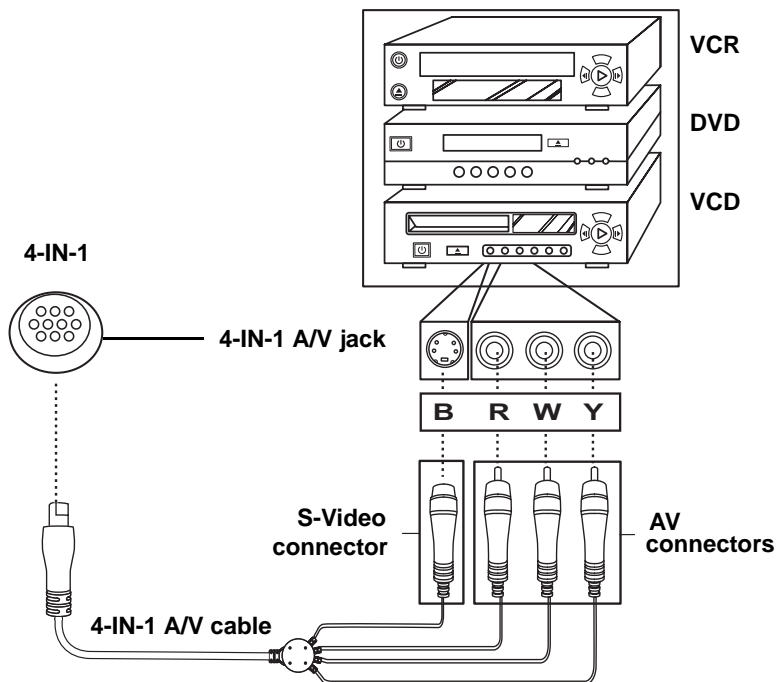

#### Note

- The cables are color-coded (black, red, white, yellow). Connect each color-coded cable to the appropriate connector on your device.
- When connecting the S-Video connector and AV connector at the same time, the priority is given to the S-Video connector.

---

## Connecting to a Video Camera

The instructions presented here are a general guide to connecting the TV to a camcorder or other type of digital camera. Actual connections may vary according to the make and model of the device. Refer to the user's manual included with the camcorder or camera for more detailed instructions.

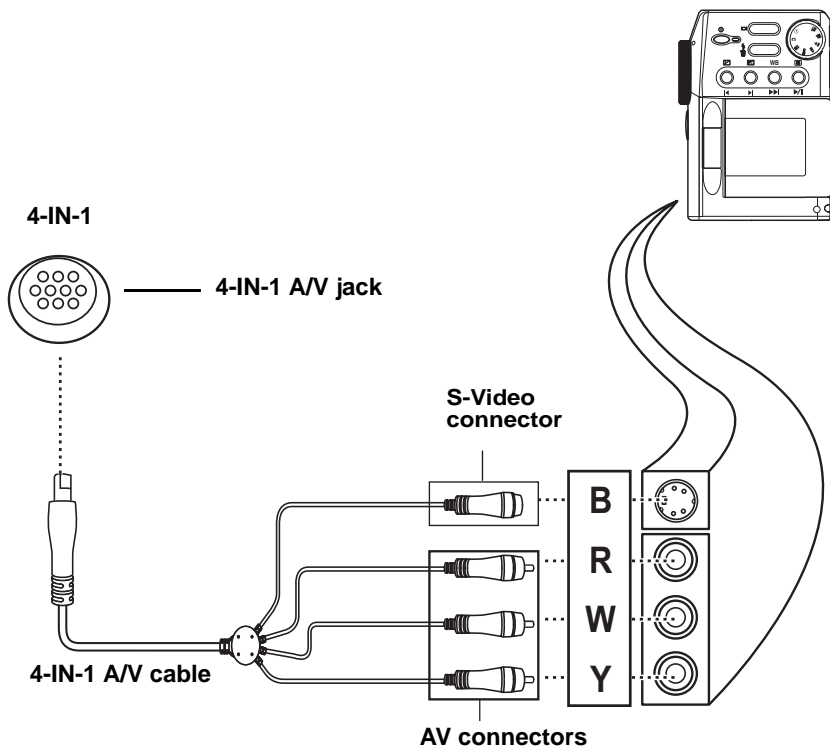

### Note

The cables are color-coded (black, red, white, yellow). Connect each color-coded cable to the appropriate connector on your device.

---

## Connecting to a Video Game Console

The instructions presented here are a general guide to connecting the TV to a game console using the RCA Jacks (some game devices may require a unique adapter that is not provided). Actual connections may vary according to the make and model of the game device. Refer to the user's manual included with the game console for more detailed instructions.

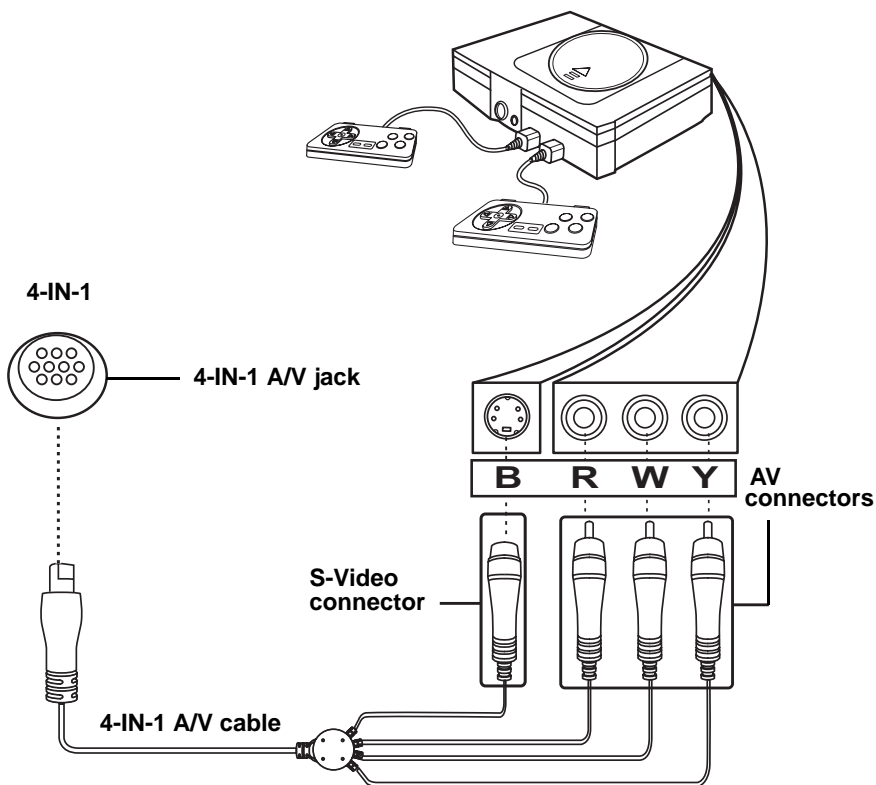

### Notes

- Connect the 4-IN-1 A/V cable connectors to the corresponding connectors on your game device adapter.
- If the 4-IN-1 A/V cable does not fit the game device, then insert RCA jack between the 4-IN-1 A/V cable and game device.

---

## Connecting External Speakers or Headphones

External speakers or headphones may be used to listen to the TV rather than using the built-in speakers. Connect external speakers with built-in amplifier to the speaker line out port or headphones to the headphone port as illustrated.

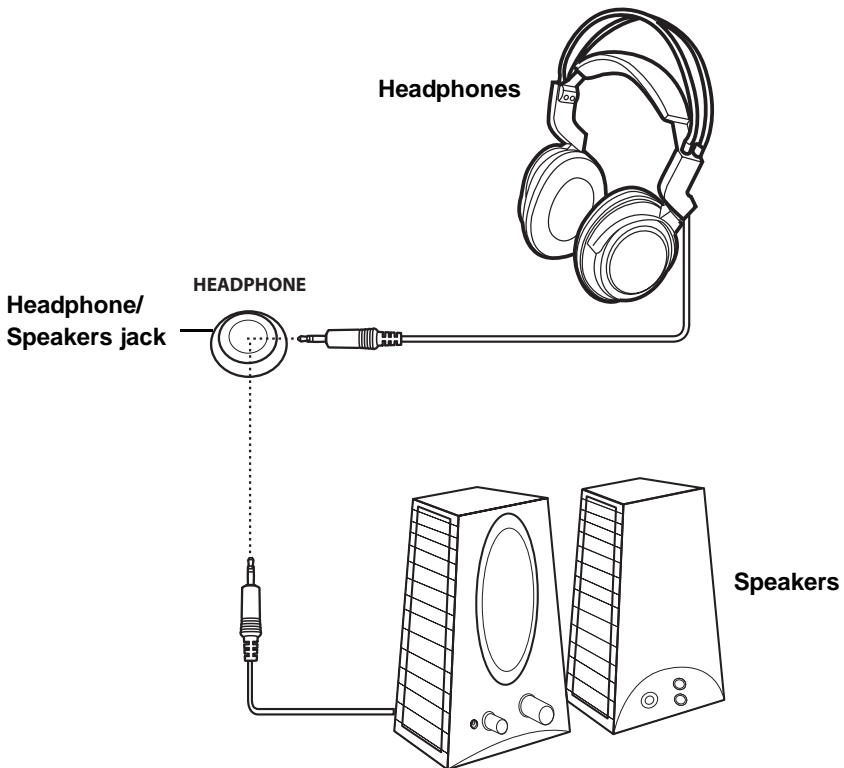

### Notes

- External speakers or headphones are not included with the TV.
- The internal TV speakers will not output sound when headphones are plugged in.
- Use external speakers with built-in amplifiers only.

---

## Connecting the Power Adapter

- 1 Connect the power cord to the power adapter as illustrated.
- 2 Plug the power adapter connector into the DC-IN input jack on the rear panel of the TV.
- 3 Insert the three-pronged plug at the other end of the power cord into a power outlet.

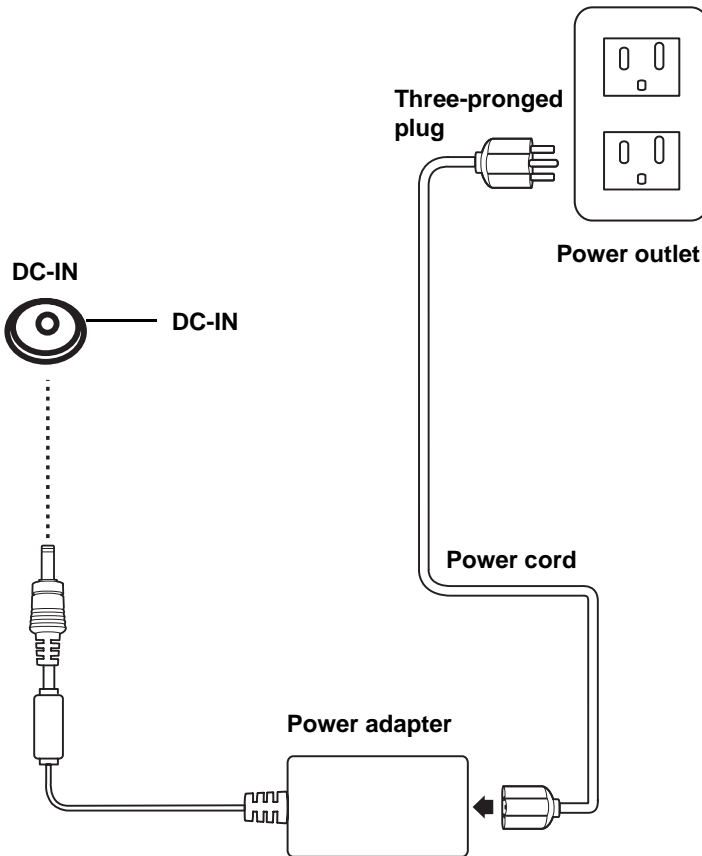

**Note**  
Images are for illustration only and may vary by model or region.



## Using the Remote Control

For best results, use the remote control within a distance of 16 feet (5 meters) from the front of the TV. Do not exceed an angle of 30 degrees when pointing at the TV.

### Notes

- **The operational distance may be shortened when the signal sensor is directly exposed to strong light.**
- **Aim the transmitter on the remote control at the signal sensor and ensure that there are no obstacles between them.**

## Turning the TV On and Off

- 1** Press power  on the remote control or control panel to turn on the TV.
- 2** Press power  again; the TV is in off mode.

## Selecting Channels

Press channel up or channel down on the control panel to select the channel or enter the specific channel number by pressing the number buttons on the remote control.

## Switching Source Signals

Press source to select the incoming source signal.

The current source setting (TV, AV or AVs) or (TV, AV1, AV2 or AV2s) appears on the upper left corner of the screen.

## Adjusting the Volume

Press volume up to increase the volume. Press volume down to decrease the volume. The volume level is displayed on the screen.

## Adjusting On-Screen Display (OSD) Settings

The On-Screen Display (OSD) menu system provides a quick and simple method to adjust your TV's settings. This chapter describes how to change each of the available settings.

### TV & Remote Control Buttons

You may adjust the setting from your remote control or the buttons located on the TV's front control panel.

Control Panel	Remote Control
– Menu – M	Menu/Enter
CH UP (▶ / △ / ► / + / ▲ / ^)	CH UP / Arrow (▲ / +) / ▲ / ► / >
CH DOWN (◀ / ▽ / ◀ / - / ▼ / v)	CH DOWN / Arrow (▼ / -) / ▼ / ◀ / <
VOL UP (+ / ▷ / ▲ / ✱)	VOL UP / Arrow (+ / ▲) / ▲ / ► / >
VOL DOWN (- / ◀ / ▼ / ✱)	VOL DOWN / Arrow (- / ▼) / ▼ / ◀ / <

#### Note

Follow the instructions indicated on the bottom of the OSD Function Menu. In the example shown here, press VOL UP or the ► arrow key to enter your setting, CH UP/DOWN or ▲/▼ arrow keys to navigate through the items, or MENU to exit the OSD menu.



---

## OSD Function Menu

The following illustration helps you become acquainted with OSD menu items.

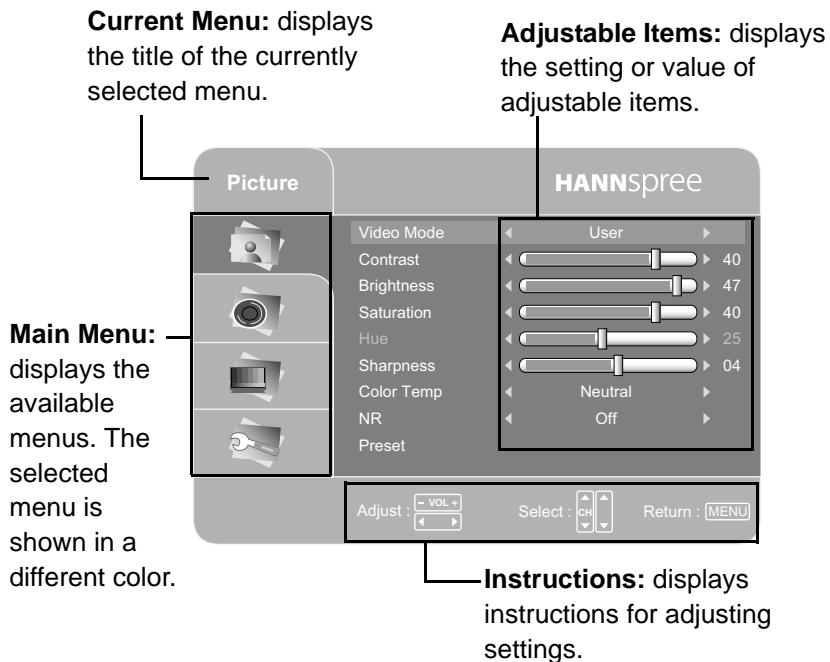

The following menus can be set using different adjustment methods, which are described in the instructions.



## Picture Setting

Press menu to enter the OSD menus.

- 1 Press **CH UP** or **CH DOWN** to select Picture Setting.
- 2 Press **VOL UP** to enter the Picture Setting menu.

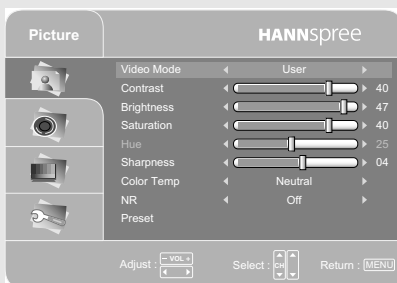

## Video Mode

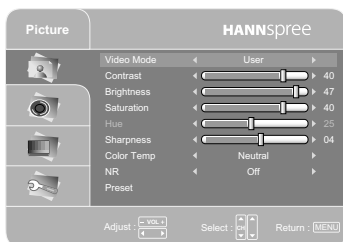

**1** Press **VOL UP** or **VOL DOWN** to switch between Video Mode options:

**User:** Enables you to set user defined values.

**Dynamic:** Sets the display for enhanced picture contrast and sharpness (default).

**Standard:** Sets the display for normal viewing (default).

**Movie:** Sets the display to emulate a movie display (default).

**2** In User mode, press **CH UP** or **CH DOWN** to select Contrast, Brightness, Saturation, Hue (does not apply to PAL system), or Sharpness.

**3** Press **VOL UP** or **VOL DOWN** to change the values. A slide bar appears for each option.

**4** Press **VOL UP** to increase the chosen option's value. Press **VOL DOWN** to decrease the value.

**5** Press menu to confirm the setting.

### Note

The new setting is confirmed automatically when the OSD times out.

## Color Temperature

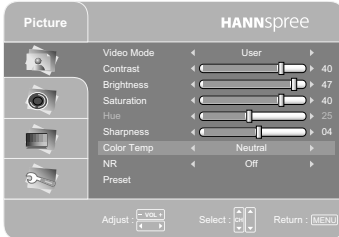

- 1 Press **CH UP** or **CH DOWN** to select Color Temp.
- 2 Press **VOL UP** or **VOL DOWN** to switch between Color Temp options: The following three color temperatures are available.
  - Neutral:** Gives white colors a neutral tint.
  - Warm:** Gives white colors a reddish tint.
  - Cold:** Gives white colors a bluish tint.
- 3 Press menu to confirm the setting.

**Note**  
The new setting is confirmed automatically when the OSD times out.

## Noise Reduction

Noise reduction enables you to reduce the amount of interference in the signal.

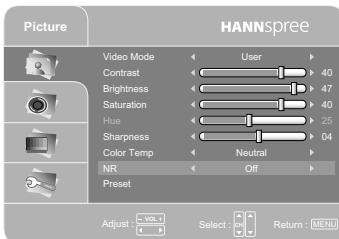

- 1 Press **CH UP** or **CH DOWN** to select noise reduction (NR).
- 2 Press **VOL UP** or **VOL DOWN** to switch between NR options:
  - Off**
  - Low**
  - High**
- 3 Press menu to confirm the setting.

**Note**  
The new setting is confirmed automatically when the OSD times out.

---

## Preset

Preset erases all customized picture settings and returns all values to factory defaults.

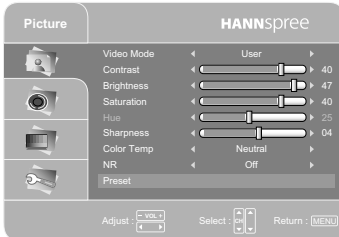

- 1 Press **CH UP** or **CH DOWN** to select Preset.
- 2 Press **VOL UP** to reset all picture settings to factory defaults. "OK" appears on the screen.
- 3 Press menu to confirm the setting.

**Note**  
The new setting is confirmed automatically when the OSD times out.

## Audio Setting

Press menu to enter the OSD menus.

- 1 Press **CH UP** or **CH DOWN** to select Audio Setting.
- 2 Press **VOL UP** to enter the Audio Setting menu.

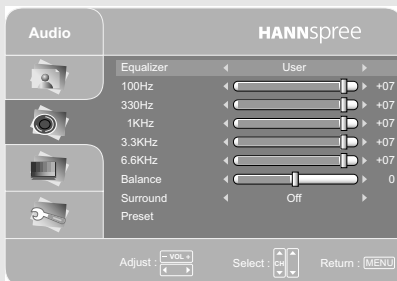

---

## Equalizer

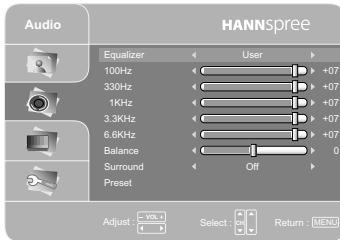

- 1 Press **VOL UP** or **VOL DOWN** to switch between Equalizer options:

**User:** Enables you to set user defined values.

**Movie:** Sets the audio to accommodate movies (default).

**Music:** Sets the audio to accommodate music (default).

**Hall:** Sets the audio to accommodate a hall environment (default).

**Flat:** Sets all frequency values to zero (default).

Selecting User enables you to set the Equalizer manually (only User used).

- 2 In User mode, press **CH UP** or **CH DOWN** to select one of the frequency bars shown.
- 3 Press **VOL UP** to increase the frequency for the chosen bar. Press **VOL DOWN** to decrease the frequency.
- 4 Press menu to confirm the setting.

### Note

The new setting is confirmed automatically when the OSD times out.

---

## Balance

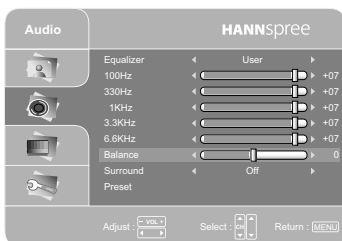

- 1 Press **CH UP** or **CH DOWN** to select Balance.
- 2 Press **VOL UP** or **VOL DOWN** to adjust the balance between left and right audio channels.
- 3 Press menu to confirm the setting.

**Note**  
The new setting is confirmed automatically when the OSD times out.

## Surround

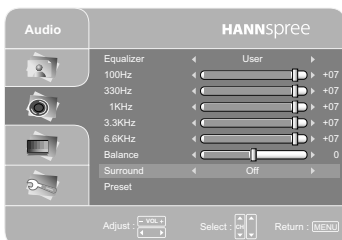

- 1 Press **CH UP** or **CH DOWN** to select Surround.
- 2 Press **VOL UP** or **VOL DOWN** to turn the surround sound feature on and off.
- 3 Press menu to confirm the setting.

**Note**  
The new setting is confirmed automatically when the OSD times out.

---

## Preset

Select this item to erase all customized audio settings and return all values to factory defaults.

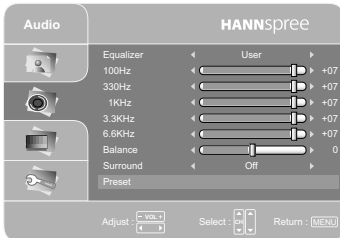

- 1 Press **CH UP** or **CH DOWN** to select Preset.
- 2 Press **VOL UP** to reset all audio settings to factory defaults. "OK" appears on the screen.
- 3 Press menu to confirm the setting.

**Note**  
The new setting is confirmed automatically when the OSD times out.



## TV Setting

Press menu to enter the OSD menus.

- 1** Press **CH UP** or **CH DOWN** to select TV Setting.
- 2** Press **VOL UP** to enter the TV Setting menu.

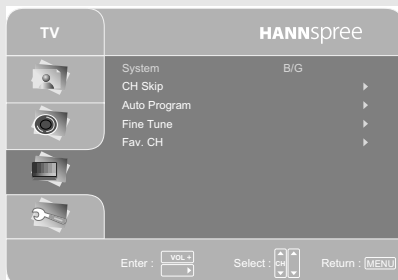

---

## System

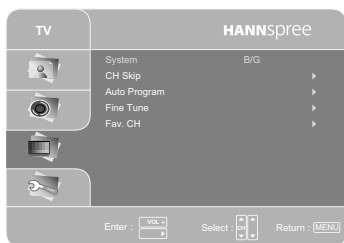

Use the System function to determine the PAL signal type  
The signal type will be detected automatically: B/G, D/K, or I.

## Channel Skip

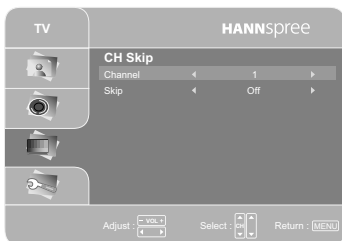
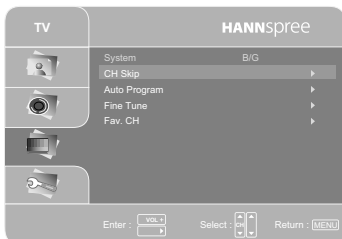

- 1 Press **CH UP** or **CH DOWN** to select CH Skip.
- 2 Press **VOL UP** to enter the CH Skip submenu.
- 3 Press **CH UP** or **CH DOWN** to select Channel.
- 4 Press **VOL UP** or **VOL DOWN** to select the channel you want to modify.
- 5 Press **CH UP** or **CH DOWN** to select Skip.
- 6 Press **VOL UP** or **VOL DOWN** to turn channel skip on or off:  
**On:** the channel is skipped when pressing **CH UP** or **CH DOWN**.  
**Off:** the channel is not skipped when pressing **CH UP** or **CH DOWN**.
- 7 Press menu to confirm the setting.

### Note

You can still access the erased channel by entering the channel number using the number keys on the remote control.

---

## Auto Program

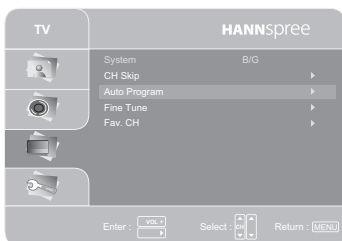

- 1 Press **CH UP** or **CH DOWN** to select Auto Program.
- 2 Press **VOL UP** to begin auto programming.
- 3 The TV will search for all available channels and add them to the channel list.
- 4 Press menu to confirm the setting.

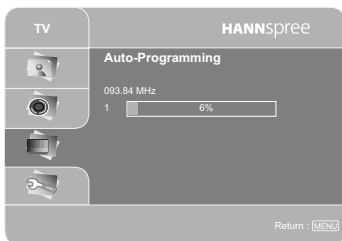

**Note**  
The new setting is confirmed automatically when the OSD times out.

---

## Fine Tune

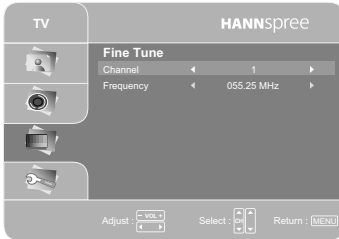
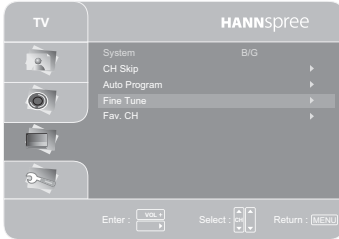

- 1 Press **CH UP** or **CH DOWN** to select Fine Tune.
- 2 Press **VOL UP** to enter the Fine Tune submenu.
- 3 Press **CH UP** or **CH DOWN** to select Channel.
- 4 Press **VOL UP** or **VOL DOWN** to select the channel you want to modify.
- 5 Press **CH UP** or **CH DOWN** to select Frequency.
- 6 Press **VOL UP** or **VOL DOWN** to adjust the frequency for the channel until the picture is clear.
- 7 Press menu to confirm the setting.

### Note

The new setting is confirmed automatically when the OSD times out.

---

## Favorite Channel

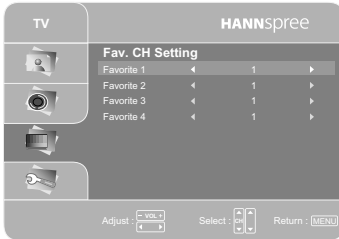
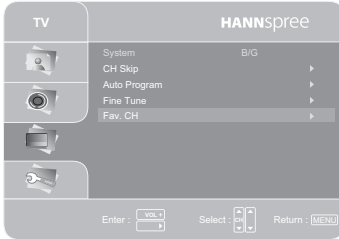

- 1 Press **CH UP** or **CH DOWN** to select Fav. CH.
- 2 Press **VOL UP** to enter the Fav. CH Setting submenu.
- 3 Press **CH UP** or **CH DOWN** to select the Favorite channel you want to modify (1 ~ 4).
- 4 Press **VOL UP** or **VOL DOWN** to select the channel you want to set as the favorite channel for that number.
- 5 Press menu to confirm the setting.

**Note**  
The new setting is confirmed automatically when the OSD times out.

## Customize Setting

Press menu to enter the OSD menus.

- 1 Press **CH UP** or **CH DOWN** to select Customize.
- 2 Press **VOL UP** to enter the Customize Setting menu.



## Sleep Timer



- 1 Press **CH UP** or **CH DOWN** to select Sleep Timer.
- 2 Press **VOL UP** or **VOL DOWN** to select a sleep timer value:  
**Off**  
**30/60/90/120 minutes**  
The TV will turn off after the specified number of minutes.
- 3 Press menu to confirm the setting.

### Note

The new setting is confirmed automatically when the OSD times out.

## OSD Timeout



- 1 Press **CH UP** or **CH DOWN** to select OSD Timeout.
- 2 Press **VOL UP** or **VOL DOWN** to select an OSD timeout value:  
**10/20/30/40/60 seconds**  
The OSD will time out after the specified number of seconds.
- 3 Press menu to confirm the setting.

### Note

The new setting is confirmed automatically when the OSD times out.



---

## Language



- 1 Press **CH UP** or **CH DOWN** to select Language.
- 2 Press **VOL UP** or **VOL DOWN** to select an OSD language:  
**English**  
简体中文  
繁體中文
- 3 Press menu to confirm the setting.

**Note**  
The new setting is confirmed automatically when the OSD times out.



Turn the power off before you begin cleaning the TV.



For best results, use a clean lens cloth to remove dust and fingerprints from the screen.



Do not wipe the shell of the TV with alcohol, methanol, gasoline or oil products to avoid damaging the finish. Wipe the shell with a dry soft cloth and use neutral cleaning fluids.

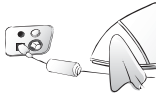

If your model has leather components, wipe the leather parts with a dry cloth and keep the area dry. Place the TV far from sources of steam to avoid making the leather wet.



Be careful to disconnect the power plug correctly. Hold the plug. Do not attempt to disconnect the plug by pulling on the power cord.

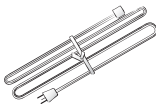

Arrange and store the power cord neatly as shown to the left to avoid knotting or bending which may cause fire due to damage or electric leakage.

### Note

**Protect the remote control from shock or vibration to avoid damage. Do not place the remote control in hot or humid locations.**

Situation	Solution
No picture and sound.	<ul style="list-style-type: none"> <li>• Connect the power cord properly.</li> <li>• Check if the power LED is on or not.</li> <li>• Press power on the control panel or remote control.</li> <li>• Press source to cycle through connected video sources.</li> <li>• Press channel up or channel down to switch to other TV stations.</li> <li>• Make sure all cables are connected properly.</li> </ul>
No picture, or poor picture, sound is OK.	<ul style="list-style-type: none"> <li>• Check the antenna and cable connections.</li> <li>• Adjust the brightness in the OSD menus. See "Color Temperature" on page 34.</li> </ul>
Picture is not in color.	<ul style="list-style-type: none"> <li>• Adjust the saturation in the OSD menus. See "Color Temperature" on page 34.</li> <li>• Make sure all the cables are connected properly.</li> </ul>
Picture is OK, no sound.	<ul style="list-style-type: none"> <li>• Make sure the source device is functioning properly.</li> <li>• Make sure the audio cable is connected securely.</li> <li>• Turn the mute off.</li> <li>• Press volume up on the control panel or remote control.</li> </ul>
One of the speakers has no sound.	<ul style="list-style-type: none"> <li>• Adjust the balance in the OSD menus. See "Balance" on page 38.</li> <li>• Make sure the audio cable is connected securely.</li> </ul>
Cannot receive some TV channels using cable TV.	<ul style="list-style-type: none"> <li>• Try the Auto Program function in the OSD "TV Setting" menu. See "Auto Program" on page 43.</li> </ul>
Want to reset TV settings.	<ul style="list-style-type: none"> <li>• Use the Reset function in the OSD menu. See "Preset" on page 35.</li> </ul>
Cannot operate menus.	<ul style="list-style-type: none"> <li>• If OSD items are colored in light blue, the system is in a state such that those settings are not available.</li> </ul>

Situation	Solution
Screen image turns over.	<ul style="list-style-type: none"> <li>• Make sure the video signal cable is connected properly.</li> </ul>
Snow appears on the screen.	<ul style="list-style-type: none"> <li>• Adjust the location of the antenna, placing it far from roads or sources of interference.</li> <li>• Check the antenna and the video signal line connections.</li> </ul>
Blurred or overlapped images.	<ul style="list-style-type: none"> <li>• Readjust the sharpness setting.</li> <li>• Choose programs with high quality signals.</li> <li>• Adjust the direction of the antenna or change the video signal cable.</li> </ul>
Remote control doesn't work.	<ul style="list-style-type: none"> <li>• Make sure the battery is inserted correctly.</li> <li>• Replace the battery with a new one.</li> <li>• Make sure the TV power cord is plugged in.</li> <li>• Make sure the path between the remote control and the sensor is clear.</li> <li>• Try operating the remote control at a closer distance to the TV. Refer to "Using the Remote Control" on page 29.</li> </ul>

For complete warranty service information, please refer to the “Warranty and Service Manual” enclosed with your TV.

9.6 / 12.1-inch LCD TV	
LCD Panel Size	9.6 / 12.1-inch TFT
Aspect Ratio	4:3
Display Resolution	<b>9.6-inch:</b> 800 (horizontal) x 600 (vertical) <b>12.1-inch:</b> 640 (horizontal) x 480 (vertical)
TV System	PAL
Video System	S-Video Input and Composite Video Input (through the 4-IN-1 A/V cable) / Composite Video Input (through the RCA jacks)
Audio System	4-IN-1 A/V cable L/R RCA jacks 3.5 mm headphone port / L/R RCA jacks
Built-in Speakers	2W + 2W / 3W + 3W
Power Supply	100-240V, 50/60 Hz, 12V DC
Power Consumption	40 W Maximum
Optional Accessories	External Speakers

**Aspect Ratio:** The ratio of width to height of a film, image or display screen.

**Color Temperature:** Adjusting the color temperature enables you to set the intensity of white light. Color temperature is measured in Kelvin (K). Higher color temperatures result in a blue tint. Lower temperatures result in a red tint.

**Hue:** Colors in a color system are measured by hue, saturation and luminance. Hue indicates the predominant color.

**LCD** (Liquid Crystal Display): A display technology that uses rod-shaped molecules (liquid crystals) that flow like liquid and bend light.

**OSD** (On-Screen Display): A control panel on the television screen that allows you to select viewing options.

**Saturation:** Chromatic purity indicating the amount of white contained in a color. Fully saturated colors are pure colors; less saturated colors appear as pastel shades.

**Stereo:** is the default audio signal belonging to a particular channel.

**S-Video:** Separate video, a video cabling standard used to transmit video by keeping brightness (Y) and color information (C) on separate channels. Most often used with camcorders, VCRs, and quality receivers and amplifiers to provide sharper pictures.







## Free Manuals Download Website

<http://myh66.com>

<http://usermanuals.us>

<http://www.somanuals.com>

<http://www.4manuals.cc>

<http://www.manual-lib.com>

<http://www.404manual.com>

<http://www.luxmanual.com>

<http://aubethermostatmanual.com>

Golf course search by state

<http://golfingnear.com>

Email search by domain

<http://emailbydomain.com>

Auto manuals search

<http://auto.somanuals.com>

TV manuals search

<http://tv.somanuals.com>