

HANNSpree

HANNSpree, Inc.
2F, No.362, Jui-Kuang Rd., Neihu District,
Taipei City 114, Taiwan, R.O.C.
TEL: 886-2-87520000
FAX: 886-2-87527092
www.hannspree.com

NTSCTVTWEN1203
MAC-000004

Download from Www.Somanuals.com. All Manuals Search And Download.

HANNSpree

15" Liquid Crystal Display Television

ST38-15A1

User's Manual

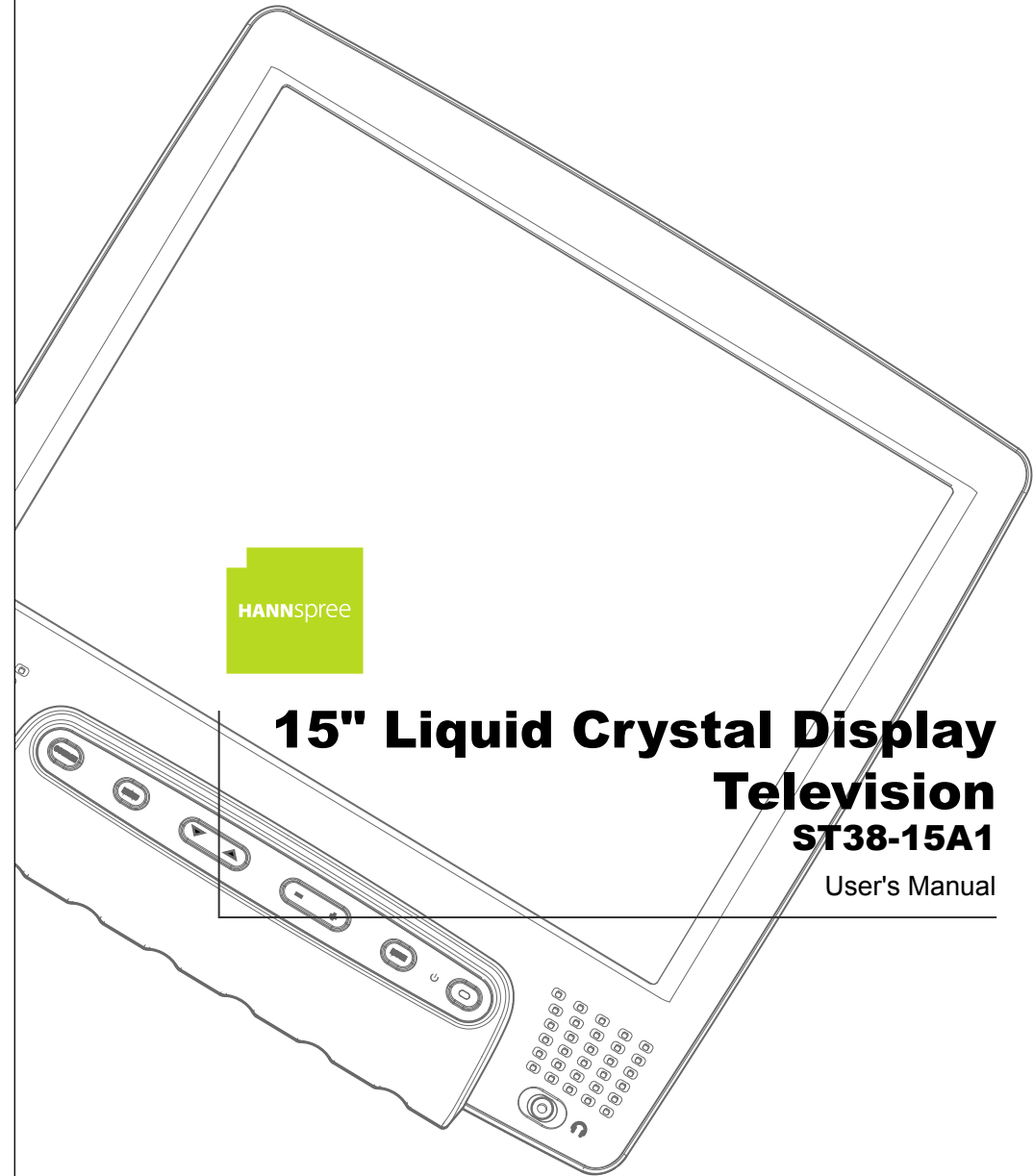

Table of Contents

1. Warranty and Service	3
2. Preface	4
3. Description of Warning Symbols.....	5
4. Safety Notices	6
5. Regulatory Information	14
6. Introducing the TV	16
Features.....	16
7. Checking Package Contents	17
8. Getting to Know Your TV	18
Front View	18
Input and Output Ports	20
9. Getting Started.....	22
Connecting to an Antenna or Cable TV	22
Connecting to AV Devices	23
Connecting to a VCR, VCD or DVD Player	23
Connecting to a Video Camera	24
Connecting Headphones	25
Connecting an Amplifier or Speakers (Build-in amplifier)	26
Connecting the Power Adapter	27
10. Using the TV	28
Using the Remote Control	28
Turning the TV On and Off	29
Selecting Channels	29
Switching Source Signals	30
Adjusting the Volume	30

Table of Contents

11. Adjusting On-Screen Display (OSD) Settings	31
OSD Setting Menus	32
Picture Setting	32
Brightness	33
Contrast	34
Sharpness	35
Hue	36
Saturation	37
Color	38
Preset	39
Audio Setting	40
Treble	41
Bass	42
Balance	43
Surround	44
Enhance	44
Preset	45
TV Setting	46
TV/CATV	47
Channel Add/Erase	48
Auto Program	49
Customize Setting	50
Sleep Timer	51
OSD Timeout	52
Language	52
12. Taking Care of Your TV	53
13. Troubleshooting	54
14. Specifications	56
15. Glossary	57

The instructions on this manual are for the model(s) listed on the front cover. Before you start reading, check your product number by looking at the rear of your TV.

Thank you for purchasing our Liquid Crystal Display Television (LCD TV). With this product, you will be able to enjoy superior audio and video while enriching your lifestyle with advanced technology.

The Hannspree TV is warranted for one year limited service from the date the product is received (as shown on the Warranty and Service Manual); please refer to the "Warranty and Service Manual" for the detailed warranty information.

Hannspree provides complete service information in the included "Warranty and Service Manual", or directly from Hannspree global customer service center. Our service representatives will be very happy to serve you to your satisfaction.

Hannspree global customer service center telephone number:
From Taiwan please call 0800-008-800

The Hannspree E-mail Address:
service@hannspree.com

This manual is designed to assist users in setting up and using the LCD TV. Information in this document has been carefully checked for accuracy; however, no guarantee is given to the correctness of the contents. The information in this document is subject to change without notice.

Copyright

© Copyright 2003 Hannspree, Inc.

All rights reserved. This product and related documentation are protected by copyright and are distributed under licenses restricting their use, copying, and distribution. No part of this documentation may be reproduced in any form by any means without prior written authorization of Hannspree, Inc., and its licensors, if any.

Warning



This symbol is used to remind users to pay attention to important descriptions regarding usage and maintenance (repair) or additional important information related to this product.

Caution



This symbol is used to remind users to pay attention to the danger of electric shocks due to dangerous internal non-insulated components.

Electric Power Notice

Electric power may cause personal injury and mechanical damage if it is misused. Although safety has been taken into consideration during the design and production of this product, electric shock or fire can result when the product is misused. To prevent potential danger, follow the instructions below when installing, operating and cleaning the product. In addition, read the following “Safety Notices” carefully before using the product to ensure that your TV is safe and long-lasting.

**Power Supply Safety Notes**

1. To avoid electric shocks, do not use an extended power cord or an outlet that does not match this product's plug or leaves the plug exposed.
2. This product has a 3-pin grounded plug. The third pin connects to ground; do not remove it.
3. If the power cord or plug is damaged or worn, unplug it immediately and contact a qualified service technician for maintenance.
4. To avoid fire or electric shocks, do not overload electric power outlets.

**Installation Safety Notes****Antenna**

We suggest that you use an outdoor antenna to get the best signal possible unless you have cable TV or a centralized indoor antenna system. You may, however, use an antenna indoors if it is placed in a location free from interference.

Location

Avoid allowing the TV to get prolonged exposure to sunlight or other strong sources of heat. Leave sufficient distance between the TV and the wall to provide enough space for the emission of heat.



Before You Proceed

1. Read the Safety Notices and the User's Manual carefully before turning the product on.
2. Keep your User's Manual in a safe place for future reference. Keep the box and packaging in case the product needs to be shipped in the future.
3. Follow the product and warning label instructions.
4. Any changes or modifications that do not follow the instructions in this manual will void this product's warranty.



Warning

To reduce the risk of fire or electric shock, do not expose this product to rain or moisture.



Power

To avoid danger of fires or electric shock, make sure that you use a proper adapter. The TV is compatible with the following adapters:

- EDAC POWER ELECTRONICS CO., LTD.: EA1050A-120
- LI SHIN INTERNATIONAL ENTERPRISE CORP.: 0218B1260

Optimal Viewing Area

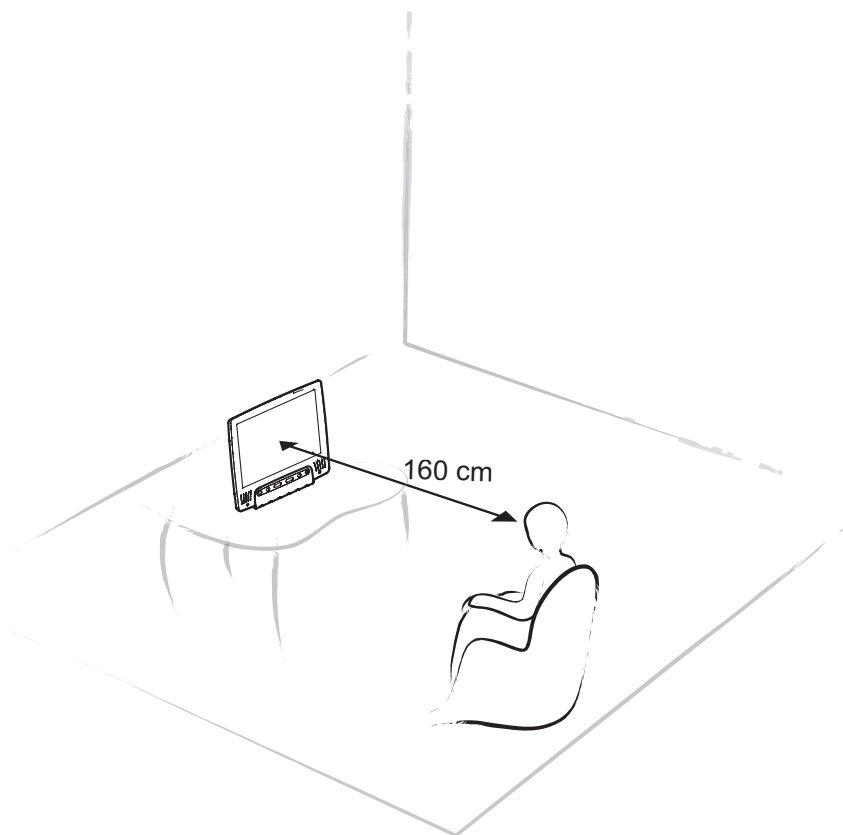

Important Safety Instructions



1. Read these instructions.
 2. Keep these instructions.
 3. Heed all warnings.
 4. Follow all instructions.
-



5. Do not use this apparatus near water.
-



6. Clean only with a dry cloth.
-



7. Do not block any ventilation openings. Install in accordance with the manufacturer's instructions.
-



8. Do not install near any heat sources such as radiators, heat registers, stoves, or other apparatus (including amplifiers) that produce heat.
-

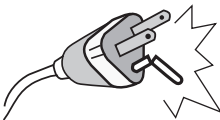

9. Do not defeat the safety purpose of the polarized or grounding-type plug: A polarized plug has two blades with one wider than the other. A grounding type plug has two blades and a third grounding prong. The wide blade or the third prong are provided for your safety. If the provided plug does not fit into your outlet, consult an electrician for replacement of the obsolete outlet.
-



10. Protect the power cord from being walked on or pinched particularly at the plug, convenience receptacles, and the point where they exit from the apparatus.



11. Use only with a cart, stand, tripod, bracket, or table specified by the manufacturer, or sold with the apparatus. When a cart is used, use caution when moving the cart/apparatus combination to avoid injury from tip-over.



12. Only use attachments/accessories specified by the manufacturer.



13. Unplug this apparatus during lightning storms or when unused for long periods of time.



14. Refer all servicing to qualified service personnel. Servicing is required when the apparatus has been damaged in any way, such as if the power-supply cord or plug is damaged, liquid has been spilled or objects have fallen into the apparatus, the apparatus has been exposed to rain or moisture, does not operate normally, or has been dropped.

Personal Safety

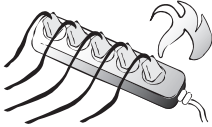

To avoid overloading the power supply, do not plug too many electrical devices into an outlet or extension cable.



Dangerous high-voltage electric power components are located inside the TV. To avoid electric shock, do not disassemble the casing.



Do not place or drop metals, small objects, or flammable materials in the vent to avoid an electric shock or a fire.



If the TV is dropped, falls down, or is otherwise damaged, unplug the power cord immediately and notify a qualified service technician.



If any fluid is sprayed or dropped into the TV, remove the power plug immediately and notify a qualified service technician.



The screen of the TV is made of glass, be careful to avoid hitting or scraping it. If the screen is broken, avoid cutting yourself on the broken glass.



Do not allow children to use the TV unattended to avoid accidents caused by improper operation.

Installation



To avoid damage to power circuits, do not place the TV in locations where there is excessive steam or dust.



Do not place the TV on a bed, sofa, carpet, or in a sealed cabinet to avoid blocking the product's vents.

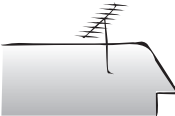

Install the outdoor antenna far from power transmission lines to avoid possible danger.



Remove the power cord and antenna connector when there is a storm or when the TV is not in use for a long period to avoid electric shock from lightning.

Operation



This product is designed for power sources as labeled on the casing. Avoid using any other power accessories to avoid electric shock or other damage.



The plug can be inserted into an outlet in only one direction. Notify a qualified service technician if you cannot plug it in correctly.



If there is any problem that cannot be resolved according to the instructions given in this manual, notify a qualified service technician immediately. Do not attempt any methods not covered in this manual.

Maintenance



Do not attempt to repair the TV by yourself. Notify a qualified service technician. Ask the service technician to complete a safety inspection before switching the power on after completing any maintenance.

FCC Compliance Statement¹

This device complies with part 15 of the FCC Rules. Operation is subject to the following two conditions: (1) This device may not cause harmful interference, and (2) this device must accept any interference received, including interference that may cause undesired operation.

This equipment has been tested and found to comply with the limits for a Class B digital device, pursuant to part 15 of the FCC Rules. These limits are designed to provide reasonable protection against harmful interference in a residential installation. This equipment generates, uses and can radiate radio frequency energy and, if not installed and used in accordance with the instructions, may cause harmful interference to radio communications. However, there is no guarantee that interference will not occur in a particular installation. If this equipment does cause harmful interference to radio or television reception, which can be determined by turning the equipment off and on, the user is encouraged to try to correct the interference by one or more of the following measures:

- Reorient or relocate the receiving antenna
- Increase the separation between the equipment and receiver
- Connect the equipment into an outlet on a circuit different from that to which the receiver is connected
- Consult the dealer or an experienced radio/TV technician for help

Warning: A shielded-type power cord is required in order to meet FCC emission limits and also to prevent interference to nearby radio and television reception. It is essential that only the supplied power cord be used. Use only shielded cables to connect I/O devices to this equipment. You are cautioned that changes or modifications not expressly approved by the party responsible for compliance could void your authority to operate the equipment.

1. applies only to products purchased in the United States of America

DOC Compliance Notice¹

This digital apparatus does not exceed the Class B limits for radio noise emissions from digital apparatus as set out in the Radio Interference Regulations of the Canadian Department of Communications. This device complies with Canada ICES-003 Class B.

CE Conformity Statement²

This device complies with the requirements set out in the Council Directive on the approximation of the Laws of the Member States relating to Electromagnetic Compatibility (89/336/EEC) and the Amendment Directive (92/31/EEC), Low-Voltage Directive (73/23/EEC) and the Amendment Directive (93/68/EEC).

-
1. applies only to products purchased in Canada
 2. applies only to products purchased in the European Union

Introducing the TV

Thank you for purchasing this Liquid Crystal Display TV. Your TV is designed to be safe, versatile, and easy to use.

The Hike design makes it a fun addition to any room.

You can watch standard NTSC television channels, and easily connect a VCR, VCD, or DVD player to the standard CVBS and S-Video input ports located at the rear of the unit.

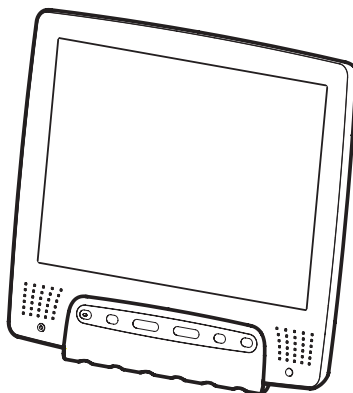

Convenient control buttons located on the front panel let you change channels, adjust the volume, and change display settings through an easy-to-use on-screen menu system. The TV speakers provide full, rich stereo sound and a convenient audio output port lets you connect to an external audio system or headphones.

Features

- 15-inch color TFT LCD TV
- Safe, sturdy construction
- Built-in TV tuner
- Audio/video support:
 - Stereo audio inputs
 - Composite video inputs
 - S-Video input
- On-screen display (OSD) menu system
- Multi-channel Television Sounds (MTS) Stereo with SAP
- Built-in 2W+2W stereo audio amplifier

7

Checking Package Contents

Make sure the following components are included in the box. Contact your vendor immediately if anything is missing or damaged.

TV

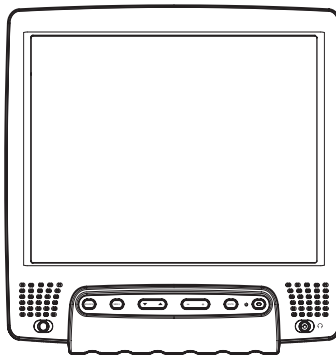

User's Manual



Quick Start Guide



Warranty and Service Manual

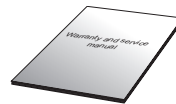

Wire Material Package

Power Cord

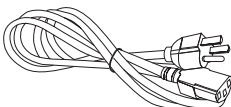

Power Adapter

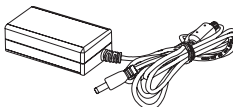

4-IN-1 Cable

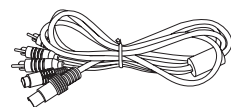

Front View

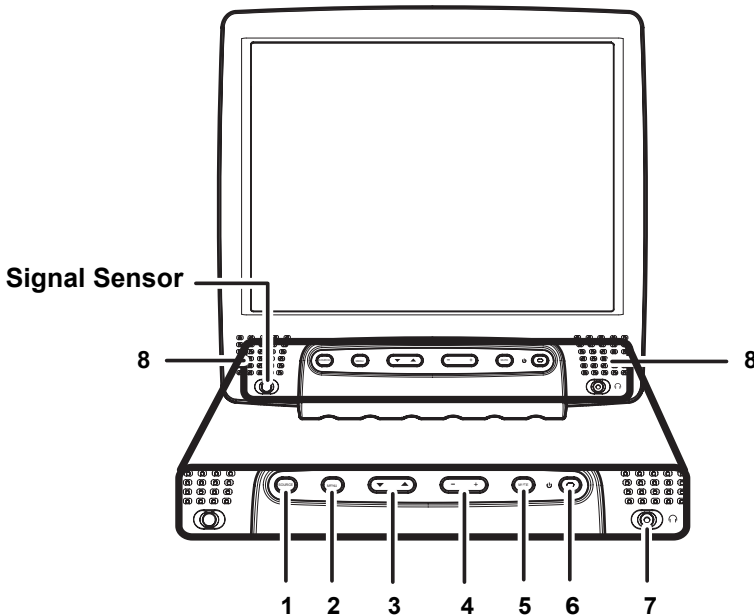

	Description	Function
1	Source	Selects the input source to be displayed (TV, AV1, or AV2).
2	Menu	Turns the on-screen display (OSD) menus on and off.
3	Select channel	Channel up (▲): Increases the channel number. Channel up (▼): Decreases the channel number.
4	Adjust volume	Volume up (+): Increases the volume Volume down (-): decreases the volume

Description		Function
5	Mute	Press this button to eliminate sound. Press the mute button again or press the VOLUME buttons directly to restore sound.
6	Power / Power LED	Turns the TV on and off. Green LED indicates power on.
7	Headphone line out	Connects to headphones.
8	Speakers	Output audio content.

Input and Output Ports

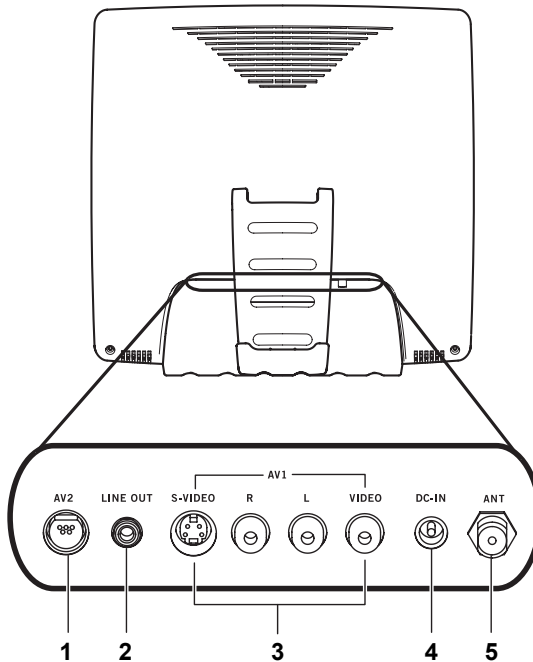

Description	Function
1 AV2	Use the included 4-IN-1 Audio/Video cable to connect external devices, such as a VCR, VCD, or DVD player. Audio Input: AV connectors white and red audio cables. Video Input: AV connector video (yellow) or S-Video cables.
2 Line out	Connects to an amplifier.

Description	Function
3 AV1	Use the AV1 input to connect an external device, such as a VCR, VCD, or DVD player. Audio Input: AV connector white and red audio cables. Video Input: AV connector video (yellow) cable.
4 DC-IN	Connects to the included power adapter.
5 Antenna/cable TV line in	Connects to an antenna or CATV cable television line.

Connecting to an Antenna or Cable TV

- 1 Connect one end of the VHF/UHF (Antenna) or CATV cable to the ANT Jack (VHF/UHF IN Jack) on the back of the TV.
- 2 Connect the other end of the VHF/UHF (Antenna) or CATV cable to the Antenna or CATV socket.

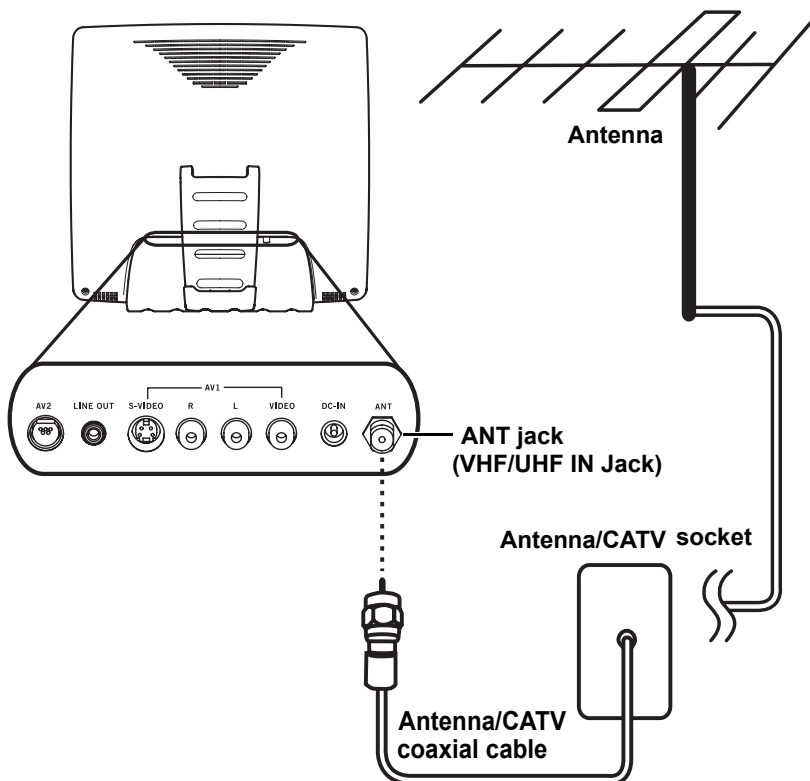

Note

If you cannot receive channels after connecting to an antenna or cable TV line, try scanning for channels. See "Auto Program" on page 49.

Connecting to AV Devices

Connect external devices such as VCD/DVD players or VCRs to the TV using the AV1 and AV2 ports on the back of the TV.

Connecting to a VCR, VCD or DVD Player

The illustration presented here shows you how to connect your TV to a VCR, VCD or DVD player. Actual connections may vary according to the make and model of your device. Refer to the user's manual included with the AV device for more detailed instructions.

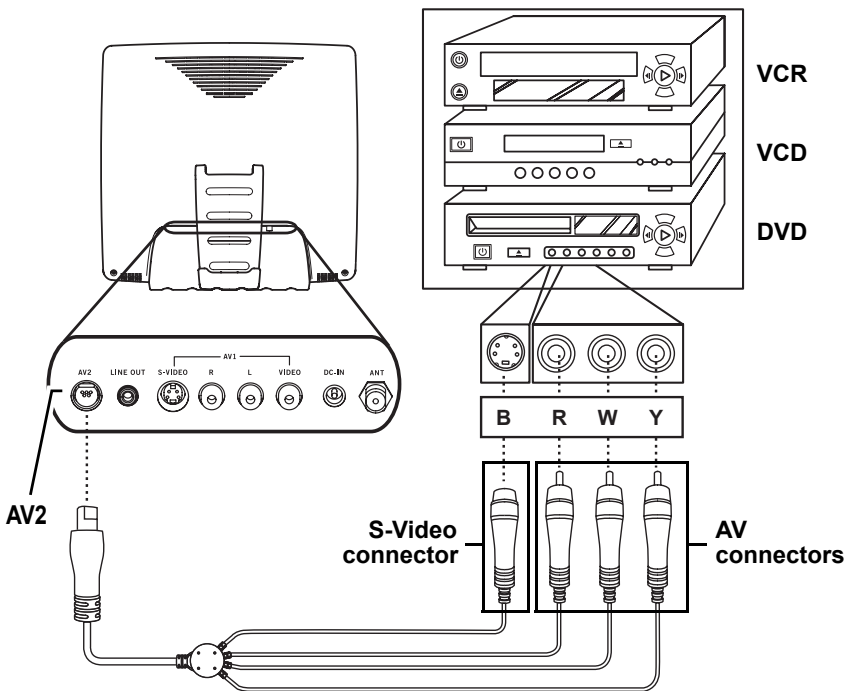

Cables and connectors are color-coded (black, red, white, yellow).

Connecting to a Video Camera

The following illustration shows you how to connect the TV to a camcorder. Actual connections may vary according to the make and model of the device. Refer to the user's manual included with the camcorder for more detailed instructions.

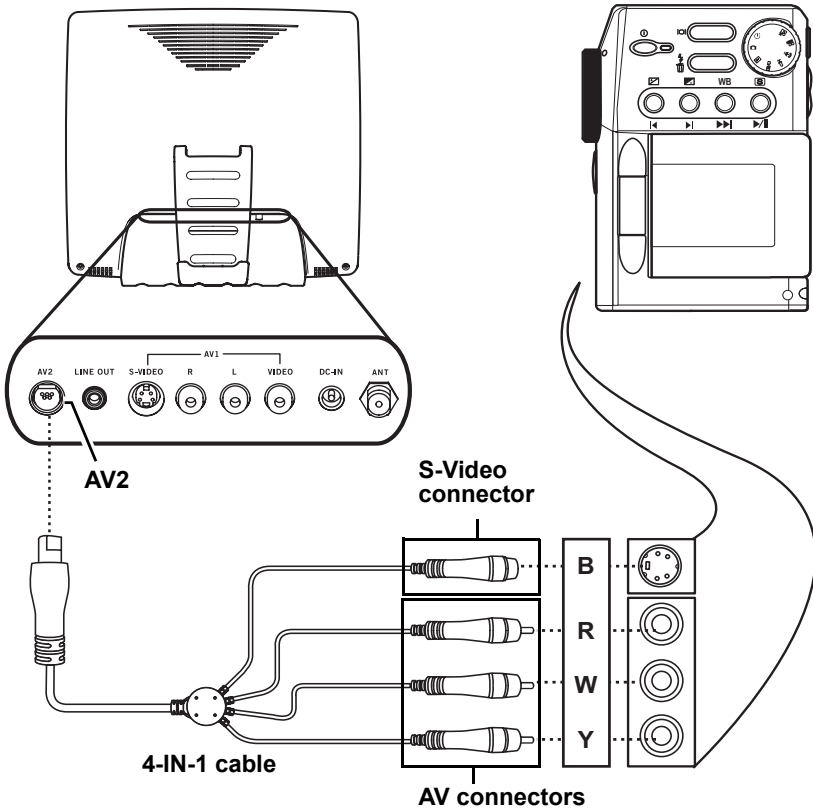

Note: When connecting the S-Video connector and AV connectors at the same time, the priority is given to the S-Video connector.

Cables and connectors are color-coded (black, red, white, yellow).

Connecting Headphones

Headphones may be used to listen to the TV instead of using the built-in speakers. Connect headphones to the headphone line out port as illustrated.

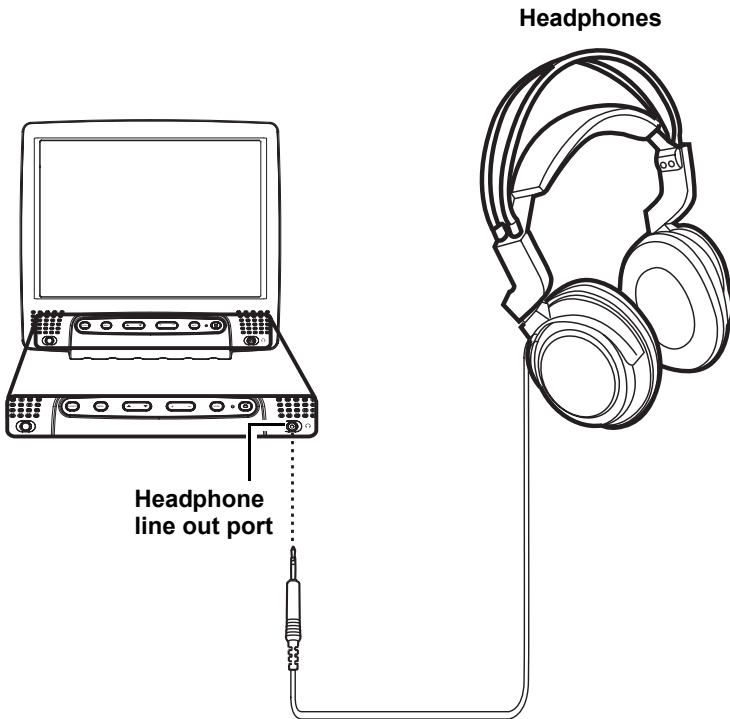

Notes

- Headphones are not included with the product.
- The internal TV speakers will not output sound when headphones are plugged in.

Connecting an Amplifier or Speakers (Build-in amplifier)

Connect an external amplifier or speakers to the line out port to provide better sound quality. Refer to the following illustration.

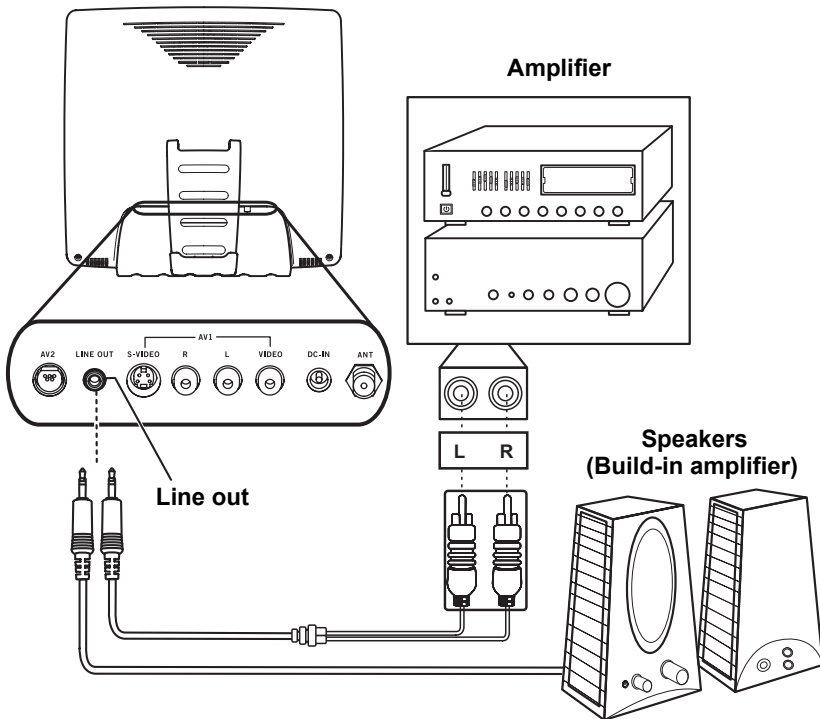

Connecting the Power Adapter

- 1 Connect the power cord to the power adapter as illustrated.
- 2 Plug the power adapter connector into the DC-IN on the rear panel of the TV.
- 3 Plug the three-pronged plug at the other end of the power cord into a power outlet.

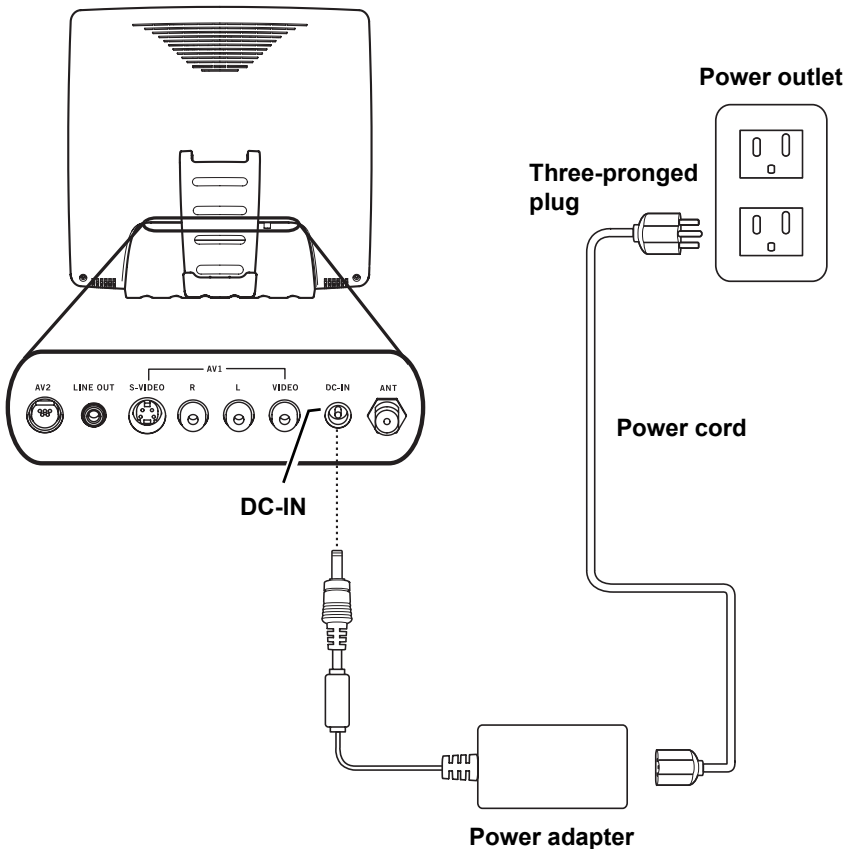



Using the Remote Control

For best results, use the remote control within a distance of 5 meters (16 feet) from the front of the TV's signal sensor. Do not exceed an angle of 30 degrees when pointing at the signal sensor. Refer to the following illustration.



Turning the TV On and Off

- 1 Press the **POWER**  button on the remote control or on the TV control panel. The power LED indicator on the front of the TV changes from red to green, indicating that the power is on.
- 2 Press the **POWER**  button again. The power LED changes from green to red, indicating that the TV is in standby (off) mode.

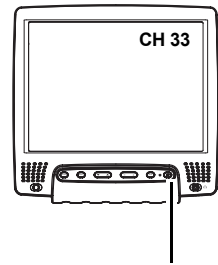

Power button
and
Power LED

Selecting Channels

- 1 Press the **CH UP** button to increase the channel number by one.
- 2 Press the **CH DOWN** button to decrease the channel number by one.
- 3 Enter the specific channel number by pressing the number buttons on the remote control. The channel is displayed on the LCD panel.

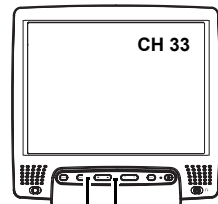

Channel down
Channel up

Switching Source Signals

Press the **SOURCE** button to select different source signals.

CH, AV1, and AV2 appear on the top right corner of the screen in that order.

Note

The TV supports S-Video input in addition to normal video and audio signals. The TV detects the signal type automatically and gives priority to S-video when two signals are detected at the same time.

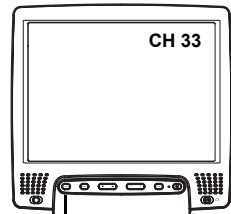

Source

Adjusting the Volume

- 1 Press the **VOL UP** button to increase the volume.
- 2 Press the **VOL DOWN** button to decrease the volume.
- 3 Press the **MUTE** button. The word "MUTE" appears on the top right corner of the screen and sound is turned off.
- 4 Press the **MUTE** button again to restore the original volume.

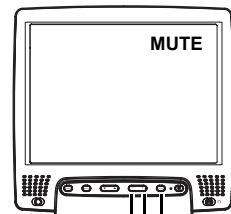

Volume down
Volume up
Mute

11

Adjusting On-Screen Display (OSD) Settings

The On-Screen Display (OSD) menu system provides a quick and simple method to adjust your TV's settings. This chapter describes how to change each of the available settings. The OSD can be used with either the front control panel or remote control.

Button Descriptions	Front Panel Control
Menu	MENU
CH Up	▲
CH Down	▼
VOL Up	+
VOL Down	-

The following sections explain how to adjust settings in the OSD menu using the front panel control. You can also use the arrow buttons on the remote control to adjust settings

OSD Setting Menus

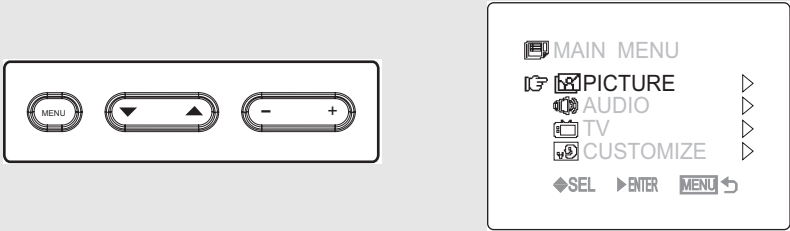

Press **MENU** to enter the OSD Main Menu screen.

The Main Menu appears.

Note

Press the **MENU** button to exit the OSD menus and submenus at any time. Repeatedly press the **MENU** button to exit the OSD menus and submenus and return to TV mode.

Picture Setting

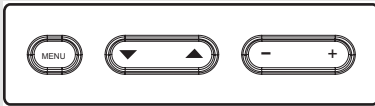

Press **MENU** to enter the OSD Main Menu screen.

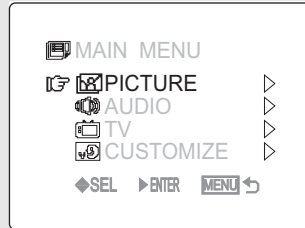

Press the **VOL UP** button to enter the PICTURE Menu.

Note

You can operate the OSD with either the remote control or the front panel control.

Brightness



1 Press the **VOL UP** button. The brightness slide bar appears.



2 Press the **VOL UP** button to increase the brightness.



3 Press the **VOL DOWN** button to decrease the brightness.

4 Press **MENU** to confirm the setting and return to the Picture Menu.

Note

The new setting is confirmed automatically when the OSD times out.

	MAX	MID	MIN
BRIGHTNESS	+12	0	-12

Contrast



- 1** Press the **CH DOWN** button to select **CONTRAST**.
- 2** Press the **VOL UP** button. The contrast slide bar appears.



- 3** Press the **VOL UP** button to increase the contrast.
- 4** Press the **VOL DOWN** button to decrease the contrast.
- 5** Press **MENU** to confirm the setting and return to the Picture Menu.

Note

The new setting is confirmed automatically when the OSD times out.

	MAX	MID	MIN
CONTRAST	30	15	1

Hue

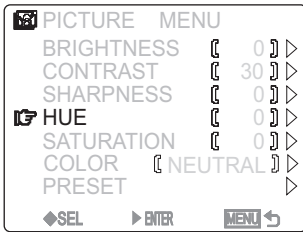

1 Press the **CH DOWN** button to select HUE.

2 Press the **VOL UP** button. The hue slide bar appears.



3 Press the **VOL UP** button to increase the hue toward the green end of the spectrum. The image becomes more green.

4 Press the **VOL DOWN** button to decrease the hue toward the red end of the spectrum. The image becomes more red.



5 Press **MENU** to confirm the setting and return to the Picture Menu.

Note

The new setting is confirmed automatically when the OSD times out.

	MAX	MID	MIN
HUE	+24	0	-24

Saturation



- 1 Press the **CH DOWN** button to select SATURATION.
- 2 Press the **VOL UP** button. The saturation slide bar appears.



- 3 Press the **VOL UP** button to increase the saturation.
- 4 Press the **VOL DOWN** button to decrease the saturation.



- 5 Press **MENU** to confirm the setting and return to the Picture Menu.

Note
 The new setting is confirmed automatically when the OSD times out.

	MAX	MID	MIN
SATURATION	+24	0	-24

Color



- 1 Press the **CH DOWN** button to select COLOR.
- 2 Press the **VOL UP** button. The current setting appears blinking in the brackets.



Neutral Color

Press the **VOL UP** button to select NEUTRAL, then press **MENU**. "NEUTRAL" appears in the brackets.



Warm Color

Press the **VOL UP** button to select WARM, then press **MENU**. "WARM" appears in the brackets.



Cold Color

Press the **VOL UP** button to select COLD, then press **MENU**. "COLD" appears in the brackets.

Note

The default color temperature is NEUTRAL.

Preset



- 1 Press the **CH DOWN** button to select PRESET.
- 2 Press the **VOL UP** button. "OK" appears in the brackets. All picture settings are returned to the factory-set default values.

Note

The preset function erases all of your custom picture settings.

Audio Setting

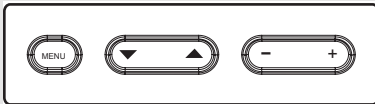

Press **MENU** to enter the OSD Main Menu screen.

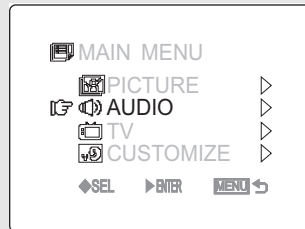

- 1** Press the **CH UP / DOWN** buttons to select **AUDIO**.
- 2** Press the **VOL UP** button to enter the Audio Menu.

Note

You can operate the OSD with either the remote control or the front panel control.

Treble

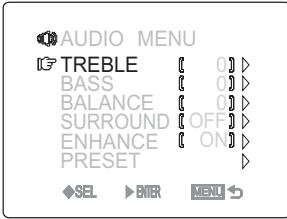

1 Press the **VOL UP** button. The treble slide bar appears.

2 Press the **VOL UP** button to increase the treble.

3 Press the **VOL DOWN** button to decrease the treble.

4 Press **MENU** to confirm the setting and return to the Audio Menu.

Note

The new setting is confirmed automatically when the OSD times out.

	MAX	MID	MIN
Treble	+24	0	-24

Bass

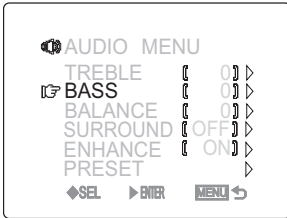

- 1 Press the **CH DOWN** button to select BASS.
- 2 Press the **VOL UP** button. The bass slide bar appears.
- 3 Press the **VOL UP** button to increase the bass.
- 4 Press the **VOL DOWN** button to decrease the bass.
- 5 Press **MENU** to confirm the setting and return to the Audio Menu.

Note

The new setting is confirmed automatically when the OSD times out.

	MAX	MID	MIN
Bass	+24	0	-24

Balance

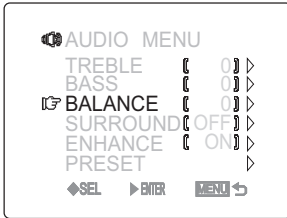

- 1 Press the **CH DOWN** button to select **BALANCE**.
- 2 Press the **VOL UP** button. The balance slide bar appears.
- 3 Press the **VOL DOWN** button to shift the balance to the left speaker.
- 4 Press the **VOL UP** button to shift the balance to the right speaker.
- 5 Press **MENU** to confirm the setting and return to the Audio Menu.

Note

The new setting is confirmed automatically when the OSD times out.

	LEFT	MID	RIGHT
Balance	-24	0	+24

Surround

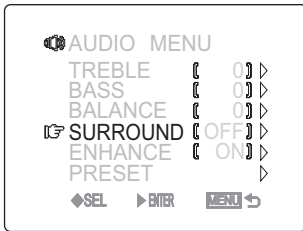

- 1 Press the **CH DOWN** button to select **SURROUND**.
- 2 Press the **VOL UP** button to enter the setting field.
- 3 Press the **VOL UP** button to turn surround on or off.
- 4 Press **MENU** to confirm your choice.

Enhance



- 1 Press the **CH DOWN** button to select **ENHANCE**.
- 2 Press the **VOL UP** button to enter the setting field.
- 3 Press the **VOL UP** button to turn enhance on or off.
- 4 Press **MENU** to confirm your choice.

Note

Turning Enhance on boosts the volume; however, if the input signal is over specification, audio distortion may occur.

Preset

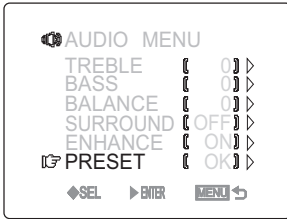

- 1 Press the **CH DOWN** button to select PRESET.
- 2 Press the **VOL UP** button. "OK" appears in the brackets. All audio settings are returned to the factory-set default values.

Note

The preset function erases all of your custom audio settings.

TV Setting

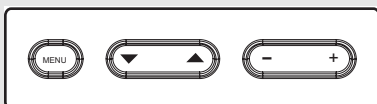

Press **MENU** to enter the OSD Main Menu screen.

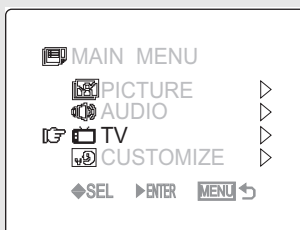

- 1** Press the **CH UP / DOWN** buttons to select TV.
- 2** Press the **VOL UP** button to enter the TV Menu.

Note

You can operate the OSD with either the remote control or the front panel control.

TV/CATV

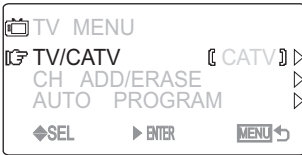

- 1 Press the **VOL UP** button. The current setting appears flashing in the brackets.

Receiving Cable TV

Press the **VOL UP** button to select CATV, then press **MENU**. “CATV” appears in the brackets.

Receiving Broadcast TV

Press the **VOL UP** button to select TV, then press **MENU**. “TV” appears in the brackets.

Note

The default TV setting is “CATV”.

Channel Add/Erase

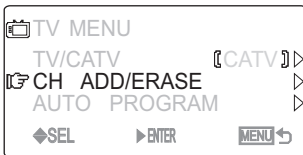

- 1 Press the **CH DOWN** button to select CH ADD/ERASE.
- 2 Press the **VOL UP** button. The OSD menu display switches to the following screen.

Press the **CH UP/ DOWN** on the front panel to select a channel.

Add Channel

Then press the **VOL UP** button on the front panel to add the selected channel. The channel number changes from yellow into green after adding the channel.



Erase Channel

Then press the **VOL DOWN** button on the front panel to erase the selected channel. The channel number changes from green into yellow after erasing the channel.



Note

You can still access the erased channel by entering the channel number using the number buttons on the remote control. Add the channel again if it was erased accidentally.

Auto Program

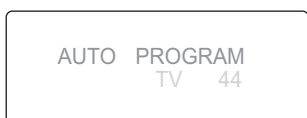

- 1** Press the **CH DOWN** button to select **AUTO PROGRAM**.
- 2** Press the **VOL UP** button to begin auto programming. The screen displays channels incrementally as the TV scans for available channels.

Note

The screen displays the first channel that is successfully found after scanning is completed.

Customize Setting

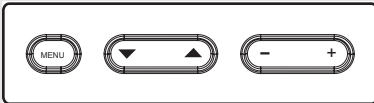

Press **MENU** to enter the OSD Main Menu screen.

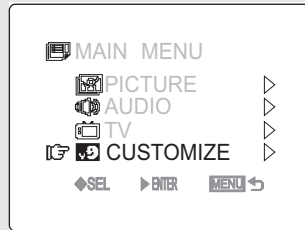

- 1** Press the **CH UP / DOWN** buttons to select **CUSTOMIZE**.
- 2** Press the **VOL UP** button to enter the Customize Menu.

Note

You can operate the OSD with either the remote control or the front panel control.

Sleep Timer

The sleep timer turns the TV off automatically after a set time.



- 1 Press the **VOL UP** button to select a value: OFF, 30, 60, 90, or 120 minutes.



- 2 Press **MENU** to confirm your choice.



You can also press **SLEEP** on the remote control to select 30, 60, 90 or 120 minutes. The setting appears on the TV screen.

The remaining time is updated every 10 minutes on the display. During the last minute, the sleep timer flashes.

OSD Timeout

This setting allows you to set the length of time the OSD menus appear on the screen when a button is not pressed.



- 1 Press the **CH DOWN** button to select OSD TIMEOUT.
- 2 Press the **VOL UP** button. The current setting appears flashing in the brackets.
- 3 Press the **VOL UP** button to select a value: 20, 40, or 60 seconds.
- 4 Press **MENU** to confirm your choice.

Language



- 1 Press the **CH DOWN** button to select LANGUAGE.
- 2 Press the **VOL UP** button. The current setting appears flashing in the brackets.
- 3 Press the **VOL UP** button to select ENGLISH or CHINESE.
- 4 Press **MENU** to confirm your choice.



Note

The default language setting is Traditional Chinese.

Taking Care of Your TV



Turn the power off before you begin cleaning the TV.



For best results, use a clean lens cloth to remove dust and fingerprints from the screen.



Do not wipe the shell of the TV with alcohol, methanol, gasoline or oil products to avoid damaging the finish. Wipe the shell with a dry soft cloth and use neutral cleaning fluids.

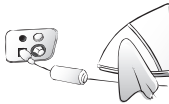

If your model has leather components, wipe the leather parts with a dry cloth and keep the area dry. Place the TV far from sources of steam to avoid making the leather wet.



Be careful to remove the power plug correctly. Hold the plug instead of pulling the power cord.

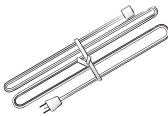

Arrange the power cord with other cords to avoid knotting or bending which may cause fire due to damage or electric leakage.

Situation	Solution
No picture and sound.	<ul style="list-style-type: none"> • Connect the power cord properly. • Press the POWER button on the control panel or remote control. • Press the SOURCE button to cycle through connected video sources. • Press the CH UP or CH DOWN button to switch to other TV stations. • Check the TV/CATV OSD settings. See "TV/CATV" on page 47. • Make sure all cables are connected properly.
No picture, or poor picture, sound is OK.	<ul style="list-style-type: none"> • Check the antenna and cable connections. • Adjust the brightness in the OSD menus. See "Brightness" on page 33.
Picture is not in color.	<ul style="list-style-type: none"> • Adjust the saturation in the OSD menus. See "Saturation" on page 37.
Picture is OK, no sound.	<ul style="list-style-type: none"> • Press the VOL UP button on the control panel or remote control. • Make sure the MTS option is set to MAIN or MONO.
One of the speakers has no sound.	<ul style="list-style-type: none"> • Adjust the balance in the OSD menus. See "Balance" on page 43.
Can't receive some TV channels using cable TV.	<ul style="list-style-type: none"> • Try the Auto Program function in the OSD "TV Setting" menu. See "Auto Program" on page 49.
Want to reset TV settings.	<ul style="list-style-type: none"> • Use the Preset function in the OSD Picture and Audio menu.
Cannot operate menus.	<ul style="list-style-type: none"> • If OSD items are colored light blue, the system is in a state such that those settings are not available. For example, video setting is available in TV mode.
No image but have sound.	<ul style="list-style-type: none"> • Make sure the video signal cable is connected properly.

Situation	Solution
No sound but have image.	<ul style="list-style-type: none"> • Make sure the source device is functioning properly. • Set the volume to a higher level. • Make sure the audio cable is connected securely. • Turn the mute off.
Screen image turns over.	<ul style="list-style-type: none"> • Make sure the video signal cable is connected properly.
Snow appears on the screen.	<ul style="list-style-type: none"> • Adjust the location of the antenna, placing it far from roads or sources of interference. • Check the antenna and the video signal line connections.
Blurred or overlapped images.	<ul style="list-style-type: none"> • Readjust the sharpness setting. • Choose programs with high quality signals. • Adjust the direction of the antenna or change the video signal cable.

ST38-15A1	
LCD Panel Size	15-inch TFT
Aspect Ratio	4:3
Best Resolution	1024 (horizontal) x 768 (vertical)
Maximum Display Area	304.1 mm (H) x 228.1 mm (V)
TV System	NTSC
Video System	AV1: Composite Video (RCA Jack; Yellow + S-Video) AV2: mini-DIN 10-pin (Composite + S-Video)
Audio System	AV1: L/R RCA jacks (audio input) AV2: mini-DIN 10-pin L/R RCA jacks (audio input) 3.5 mm headphone/line out jacks (audio output)
Built-in stereo audio amplifier	2W + 2W
Power Supply	100~240V, 50/60 Hz, 12V DC
Power Consumption	42W Max.
Weight (including base)	3.4 KG
Dimensions (including base)	353 mm (H) x 362 mm (W) x 153 mm (D)

Aspect Ratio The ratio of width to height of a film, image or display screen.

Broadcast TV Broadcasting video signals using high-frequency electromagnetic waves to distribute television channels to viewers (standard TV broadcast).

CATV Community Antenna Television, the original name for cable TV. A television distribution system that uses coaxial cable instead of the traditional radio broadcasting (over-the-air) method to deliver television, FM radio, and other services to consumers.

Color Temperature Adjusting the color temperature enables you to set the intensity of white light. Color temperature is measured in Kelvin (K). Higher color temperatures result in a blue tint. Lower temperatures result in a red tint.

Hue Colors in a color system are measured by hue, saturation and luminance. Hue indicates the predominant color.

LCD Liquid Crystal Display. A display technology that uses rod-shaped molecules (liquid crystals) that flow like liquid and bend light.

MAIN is the default audio signal belonging to a particular channel.

MTS Multi-channel Television Sound. Enables reception of audio other than the primary (MAIN) audio signal. SAP (Second Audio Program) enables reception of a separate channel that may be a different language or completely different information such as the news.

RCA connector An RCA or phono connector is a plug and socket for a two-wire (signal and ground) coaxial cable that is widely used to connect audio and video components. RCA sockets are commonly found at the rear of A/V equipment.

Saturation Chromatic purity indicating the amount of white contained in a color. Fully saturated colors are pure colors; less saturated colors appear as pastel shades.

S-Video Super-video, a video cabling standard used to transmit video by keeping brightness (Y) and color information (C) on separate channels. Most often used with camcorders, VCRs, and quality receivers and amplifiers to provide sharper pictures.

Free Manuals Download Website

<http://myh66.com>

<http://usermanuals.us>

<http://www.somanuals.com>

<http://www.4manuals.cc>

<http://www.manual-lib.com>

<http://www.404manual.com>

<http://www.luxmanual.com>

<http://aubethermostatmanual.com>

Golf course search by state

<http://golfingnear.com>

Email search by domain

<http://emailbydomain.com>

Auto manuals search

<http://auto.somanuals.com>

TV manuals search

<http://tv.somanuals.com>