

**Built-In Dishwasher**

---

**Lave-Vaisselle Encastrable**

---

**Lavaplatos Empotrable**

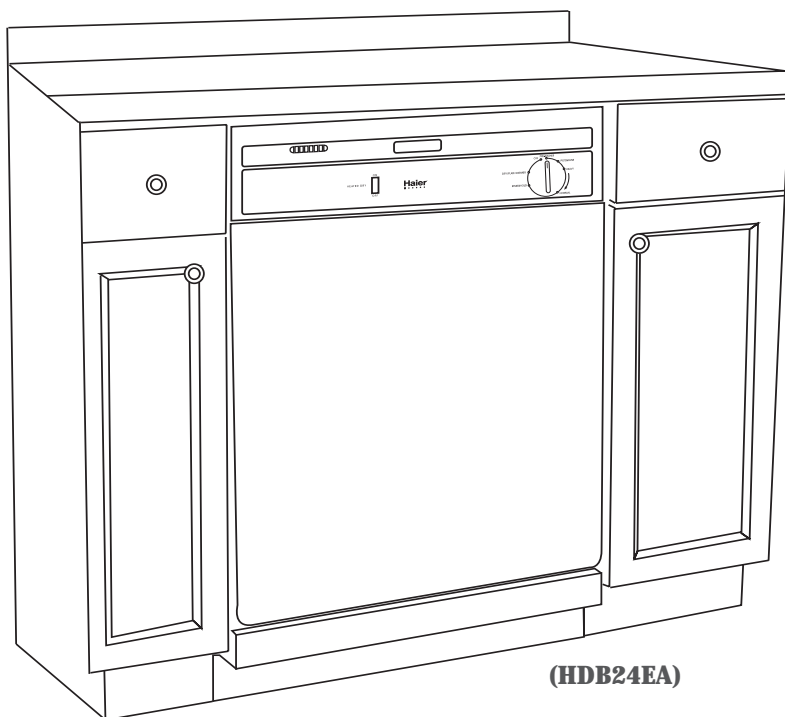

**(HDB24EA)**

**User Manual**

**Model # HDB24EA, HDB24VA**

---

**Guide de l'Utilisateur**

**Modèle # HDB24EA, HDB24VA**

---

**Manual del Usuario**

**Para Modelo de # HDB24EA, HDB24VA**



Quality ■ Innovation ■ Style

Download from [www.Somanuals.com](http://www.Somanuals.com). All Manuals Search And Download.

## IMPORTANT SAFETY INSTRUCTIONS

**Warning – To reduce the risk of fire, electric shock, or injury to persons when using your appliance, follow basic precautions, including the following:**

1. Read all instructions before using the appliance.
2. Use this appliance only for its intended purpose as described in this use and care guide.
3. Use only automatic dishwashing detergent and rinse agent recommended for use in this appliance and keep them out of the reach of children because they are corrosive and can be harmful.
4. This appliance must be properly installed in accordance with the installation instructions before it is used.
5. Never unplug your appliance by pulling on the power cord. Always grasp the plug firmly and pull straight out from the outlet.
6. Replace immediately worn power cords, loose plugs/power outlets.
7. Unplug your appliance before cleaning or before making any repairs.
8. Do not open the dishwasher door immediately after completion of wash process or during the operation as hot air/steam may cause personal injury. Press the door latch, wait few seconds by allowing cold air to go in and then open the door.
9. Do not operate your appliance in the presence of explosive fumes.
10. Do not add or mix any flammable or explosive substances to the wash.
11. Appliance loading door must be closed during the operation of the machine.
12. Do not operate your appliance when parts are missing or broken.
13. Do not use this appliance for commercial dishwashing purpose.
14. Do not operate this appliance unless all enclosure panels are properly in place.
15. Do not tamper with controls.
16. To reduce risk of injury do not allow children to play in or on the appliance. Close supervision of children is necessary when the appliance is used near children.
17. This appliance must be connected to proper electrical outlet with the correct electrical supply.
18. Proper grounding must be ensured to reduce the risk of shock and fire. DO NOT CUT OR REMOVE THE GROUNDING PLUG. If you do not have a three-prong electric receptacle outlet in the wall, have a certified electrician install the proper receptacle. The wall receptacle MUST be properly grounded.
19. Hydrogen gas may be produced if the water heater has not been used in more

then 2 weeks. This could be explosive and can explode under certain circumstances. If this is the case, turn on all the hot faucet and let the hot water run for a few minutes before using this appliance. This will let the trapped hydrogen escape. To avoid an accident, as hydrogen gas is flammable and can explode, do not turn on an electric appliance, smoke, light a match/lighter or use a flame.

20. Do not repair or replace any part of the appliance or attempt any servicing unless specifically recommended in the user-repair instructions that you understand and have skills to carry out.
21. To reduce the risk of electric shock or fire, do not use extension cords or adapters to connect the unit to electrical power source.
22. Do not wash any heat sensitive or any other items that are not designed for automatic dishwasher. Items not dishwasher safe could become deformed or melt and create a potential fire hazard.
23. Do not use this dishwasher outdoors.
24. Do not leave the dishwasher door open to dry dishware while children are around the counter. Close supervision and observation needed when children are around the dishwasher.
25. Do not abuse, sit on or stand on the door or dish rack of the dishwasher.
26. Do not touch the heating element during or immediately after use, it may be very hot.
27. Load sharp objects such as knives and forks upside down to reduce the risk of cut type injuries.
28. Do not wash plastic items unless they are marked dishwasher safe. Check the manufacturer's recommendations for items not marked.
29. Do not load sharp items near the door; you could damage the door seal.
30. When removing an old dishwasher from service or discarding it, remove the front door.
31. Disconnect electrical power and water inlet hose to dishwasher before servicing.

**SAVE THESE INSTRUCTIONS  
FOR FUTURE USE**

# Table Of Contents

	PAGE
SAFETY INSTRUCTIONS	1-2
Knowing Your Dishwasher	4-6
Using Your Dishwasher	7-16
Dishwasher Safe or Hand Wash	17-19
Care & Cleaning Of Your Dishwasher	20
Troubleshooting	21-24
Warranty	25

Thank you for using our Haier product. This easy-to-use manual will guide you in getting the best use of your dishwasher.

Remember to record the model and serial number. They are on a label on the door of the dishwasher.

---

Model number

---

Serial number

---

Date of purchase

Staple your receipt to your manual.  
**You will need it to obtain warranty service.**

## DANGER

**Risk of child entrapment. Before throwing away your old appliance, remove the door so that children may not easily become trapped inside.**

# Knowing Your Dishwasher

## Parts and Features

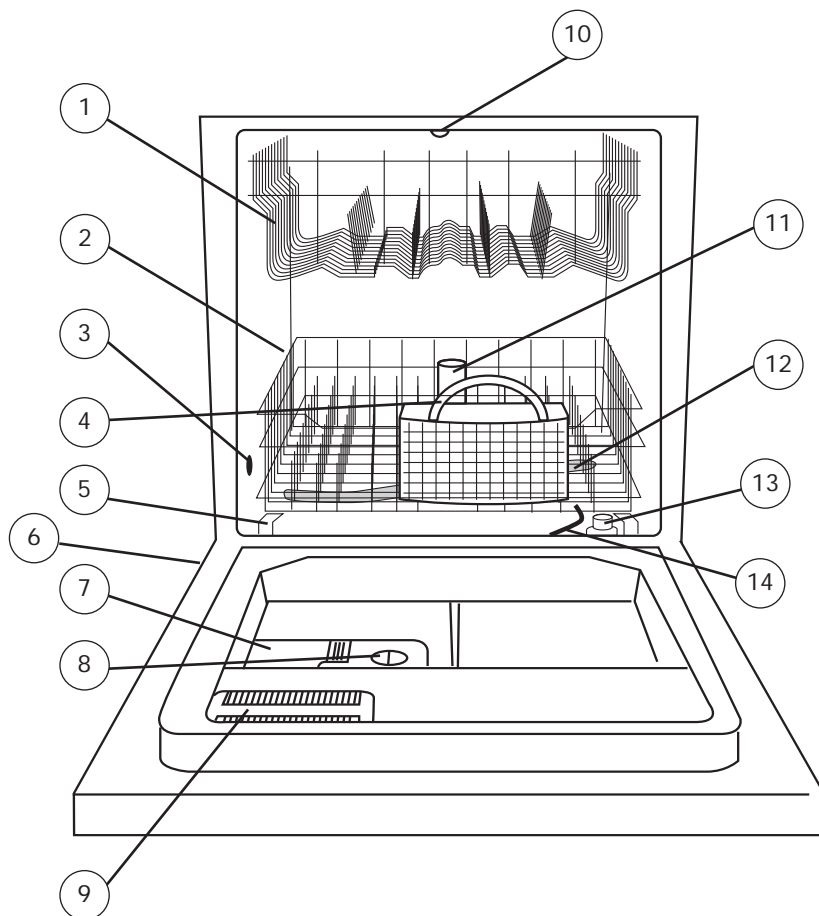

- |                                      |   |
|--------------------------------------|---|
| 1. Top rack                          | 10. Upper Wash Sprayer<br>(only in HDB24VA)   |
| 2. Bottom rack                       | 11. Spray tower                               |
| 3. Water inlet opening (in tub wall) | 12. Lower spray arm                           |
| 4. Silverware basket                 | 13. Overfill protection float                 |
| 5. Rack bumper                       | 14. Heating element                           |
| 6. Model and serial number label     | 15. 4 Adjustable leveling legs<br>(not shown) |
| 7. Detergent dispenser               |   |
| 8. Rinse aid dispenser               |   |
| 9. Vent                              |   |

(Front view with door closed)

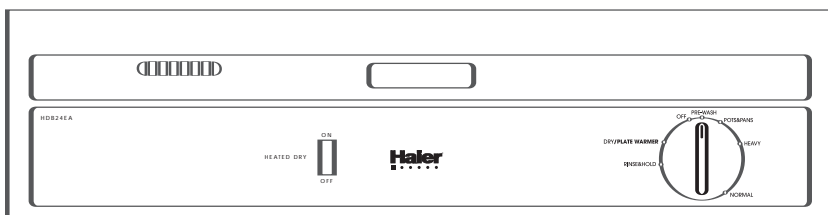

(HDB24EA)

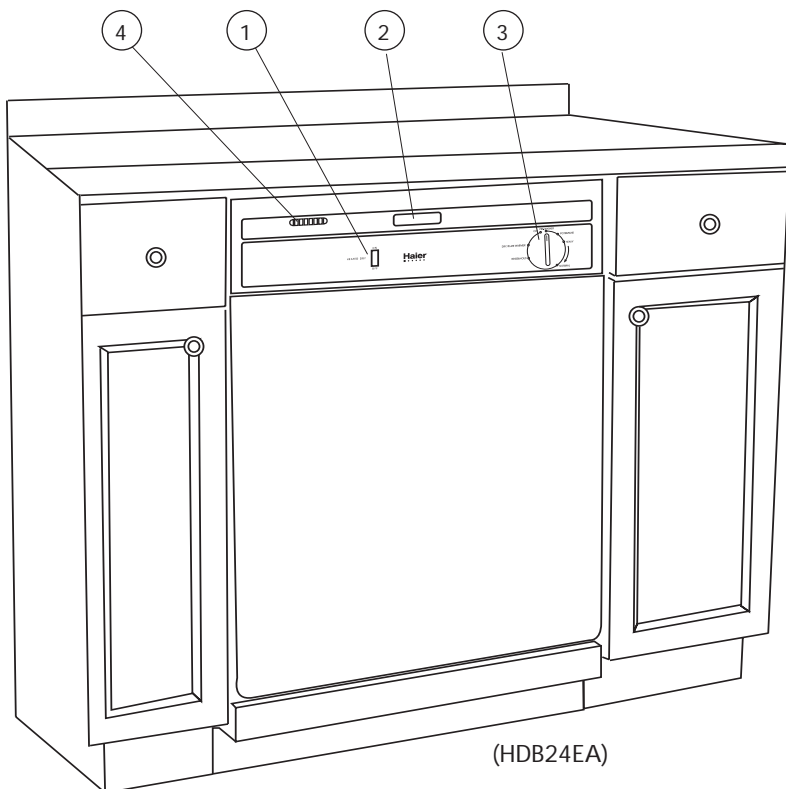

(HDB24EA)

- |                      |                        |
|----------------------|------------------------|
| 1. Heat dry [on/off] | 3. Cycle selector knob |
| 2. Door handle       | 4. Air Vent            |

(Front view with door closed)



(HDB24VA)

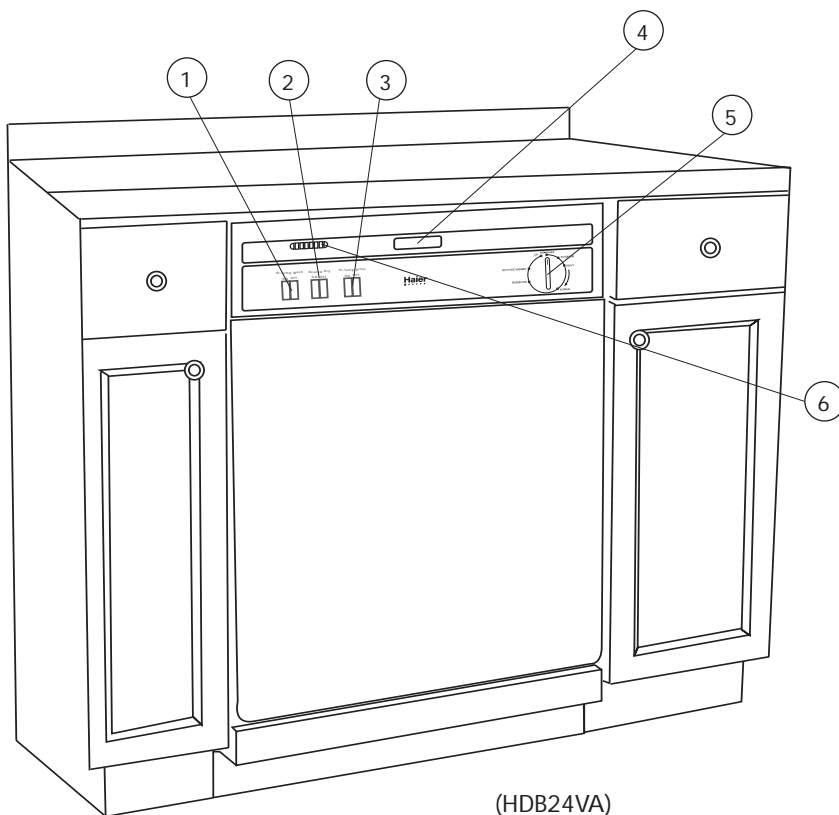

(HDB24VA)

1. Hi-Temp Wash
2. Heated Dry
3. Hi-Temp Rinse

4. Door Handle
5. Cycle Selector Knob
6. Air Vent

# Using Your Dishwasher

## Dishwasher Control Panel

### HDB24EA

#### Heated Dry button:

- Press "Heated Dry" button to turn the feature "ON" or "OFF".



#### Door latch

- To lock the door, push the door with light force until you hear the "click".
- To unlock the door, squeeze the door latch and pull towards you.



#### Cycle selector knob

- To select a wash cycle, turn the knob "CLOCKWISE" to your desired setting by matching the knob "Pointer" to the cycle. Once both are lined up, the wash process begins.

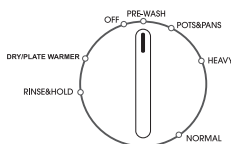

**Warning:** The wash selector knob is designed to work only in a clockwise direction. DO NOT turn the knob "COUNTER CLOCKWISE." Turning in a counter clockwise direction may cause damage to the wash selector.

#### Selecting wash cycles

- Select the appropriate cycle based on the load and soil level. For your convenience, the dishwasher has Prewash, Pots & Pans, Heavy Normal, and Rinse & Hold wash cycles that you can select from.

#### Prewash

- This is used for an extremely heavy soiled load.

#### Pots & Pans Wash Cycle

- This cycle is used for heavily soiled pots & pans, hard to clean cookware, dishware, silverware and glassware items with dried-on or baked-on soils.

*Note: This cycle may not remove burned-on foods.*

#### Heavy

- Use this cycle for a fully loaded and a heavily soiled load.



**Normal Wash Cycle:**

- This cycle is used for normal amount of soiled dishware, glassware and silverware.

**Rinse & Hold Cycle:**

- This cycle is used for rinsing partial loads that will be washed later

**Note:** *Do not use detergent or Heated Dry feature with the Rinse & Hold cycle.*

**Dry/Plate Warmer Cycle:**

- To use plate warmer feature, fill the racks with **clean, dry plates**. Turn the control knob to dry and put the Heated Dry to the “on” position. When the cycle is complete, the dishes will be warm and ready for serving.

**Warning:** *Handle with care for some plates may be too hot to handle with bare hands.*

**Heated dry option**

- Activating this option will turn on the heating element to hasten the drying process.

HDB24VA

**Heated Dry button:**

- Activating this will turn on the heating element to hasten the drying process. This needs to be “on” when using plate warmer feature.

**Hi-Temp Wash button:**

- Activating this will raise the temperature of the water above 140°F before the main wash. This is mostly used for greasy/oily loads.

**Hi-Temp Rinse button:**

- Activating this feature will raise the temperature of the water to above 140°F before the last rinse cycle. This will help to dry the dishes faster and will reduce water stain.

### Wash process

1. Load all the items in the racks and silverware basket as needed.

**Note:** *Covering the spray tower will affect the cleaning of the wash load. The spray arm must be able to properly rotate freely. Make sure that the pot handles and other like items do not interfere with the rotation.*

2. Pour the proper amount of detergent into the detergent dispenser.
3. Close the door until you hear it click shut.
4. If you need to use the "Heat dry" option, you must do so before setting the wash cycle.  
**Note:** *This option must not be selected with Rinse & hold cycle.*
5. Select the desired wash cycle. The wash process will begin at this time.

**Warning:** **Keep children away from the machine when the door is opened because the moist hot air exiting out of the door may cause harm.**

### Pausing a wash cycle

If you need to pause the dishwasher in the middle of the cycle to add or remove any items:

1. Open the door by squeezing the door latch slowly.  
**Note:** *Be careful moist hot air may rise out of the dishwasher.*
2. Add or remove items. Once you have finished adding or removing, simply close the door.
3. The washing cycle will now be resumed.

### Open door protection

Dishwasher will stop automatically if the door is opened during the operation. Once the door is closed the cycle will resume automatically.

### Preparing to Wash Dishes

To get best results, practice the following before you put dishware in the dishwasher:

- Discard big chunks of food from the plate before loading.
- Remove sticky foods and loosen burned-on foods before loading.
- Empty liquids such as juice, soup, soda, coffee or tea from glasses and cups before loading.
- Rinse off acid based liquid, such as vinegar or lemon juice right a way. Failure to do so may cause discoloration to plates, food containers and internal cabinet.
- It is not necessary to rinse the dishes before loading the dishwasher. Food particals in the dishwasher will be disposed of by the built-in food disposal.

### Tips to avoid stains and films

The following suggestions are recommended to prevent stains and films on dishware and utensils:

- Some citric based food products, coffee, tea and iron deposits in water can cause a yellow or brown film on the inside surface if left for a long time period.
- You must check water hardness to measure the amount of detergent needed to wash. If water is extremely hard, then it may be causing stains on items. You may need to use a water softener.
- Do not overload the dishwasher.
- Use the recommended water temperature to wash dishware.
- Do not use too little detergent.
- Do not use old or damp powder detergent.
- Do not load aluminum utensils improperly. Aluminum utensils can cause gray or black marks to appear on porcelain utensils if they are touching during wash cycle.

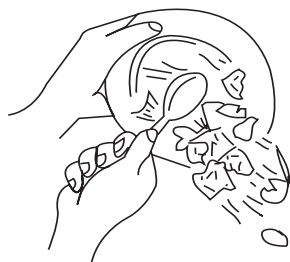

## Loading the lower & upper rack



(upper rack)

**Note:** Do not wash any heat sensitive or any other items that are not designed for automatic dishwasher.

- Keep all tall dishware and food containers from covering the spray tower.
- Place food containers such as cups, glasses, bowls, saucepans and casserole dishes with soiled surface facing downward.
- To avoid any type of damage to glassware such as cups, beverage, wine and champagne glasses, do not load them on the bottom rack. Place these items on the upper rack.
- Do not load dishware or food containers that are made of wood or iron. These items are not considered dishwasher safe.
- Place delicate items on the upper rack.

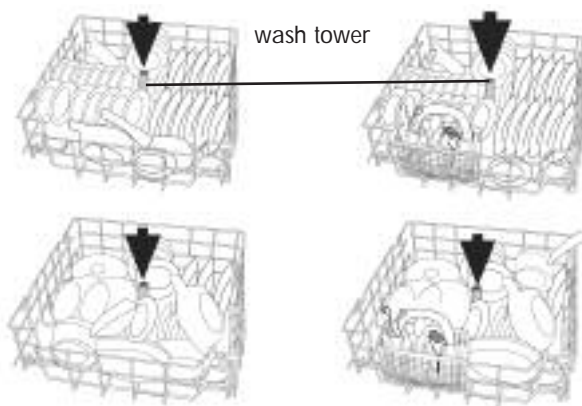

(lower rack)

- All dishware and glassware items should be securely in place when loading to avoid falling over or striking against each other.

### HDB24VA

- This unit has a 3 level wash. The lower spray arm, the middle tower and the upper sprayer.
- Three wash levels wash and clean both the upper and the lower wash loads from the top and bottom.

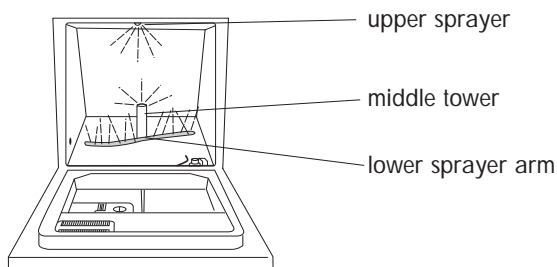

### HDB24EA

- This unit has a 2 level wash. The lower spray arm and the middle tower.
- Two wash levels wash and clean both the upper and the lower wash loads from the bottom.

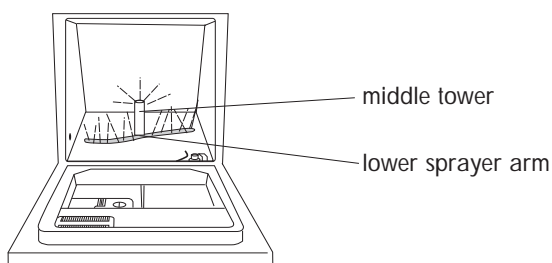

### Proper Use of Detergent

- The amount of detergent to use depends on the type of water in your area. Hard or soft water and if items are lightly or heavily soiled will affect the amount of detergent to use.
- Water softness or hardness is measured in grains content per gallon (gpg). You can find out the gpg level by calling your local Environmental Protection Agency (EPA) in your county.
- If you find that the gpg level is higher in the water, then the water will be harder in your living area. You will need more detergent to clean. If gpg level is lower, then the water will be softer in your living area so you will need less detergent to clean.

See the following table to understand the "water hardness type" and gpg level.

Water hardness type	gpg
hard	10+
medium	4-9
soft	0-3

**Note:** *If gpg level is over 12, then water is very hard. You may need water softener to improve the water quality and the performance of your dishwashing.*

*The quality of the detergent will make a big difference in the cleaning of dishes. Detergent that is damp or too old will not give an effective clean because the active ingredients are phased off.*

**Note:** *Use only "Automatic Dishwasher Detergent" for your dishwasher. Other types of detergents that are not for dishwasher use may cause over suds and foaming. Do not use detergents that are dried, caked or moist. These types of detergents will not dissolve properly*

## Filling Dishwasher Detergent

Use the recommended amount of detergent for your wash loads. Measure and pour the detergent into the large compartment for the main wash. The detergent for the pre-wash goes into the small compartment next to the main wash compartment. Push the cover latch in to open dispenser compartment door.

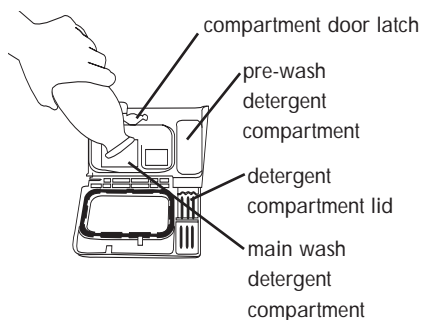

**Note:** For the pre-wash you should use one-half the amount of detergent that you use for the main wash.

- We recommend that you use a **Rinse Agent** to help remove spots and prevent new film build-up on your dishes, glasses, flatware, cookware and plastic.

**Note:** Use only a liquid form of rinse agent in the dispenser.

## Pouring liquid rinse agent into the dispenser

Use the recommended amount of rinse agent for your wash loads. The rinse agent dispenser is located next to the detergent dispenser. During the wash cycle, it automatically releases a preset amount of rinse agent during the last rinse cycle.

To fill rinse agent in the dispenser turn the knob on the dispenser in a counter clock direction. One the knob is lined up with the marker pull off the knob. Now you can pour liquid rinse agent in the dispenser.

When the dispenser is full, the see through rinse agent level indicator will be dark. When it is empty, it will be clear which means you need to pour in more.

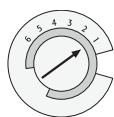
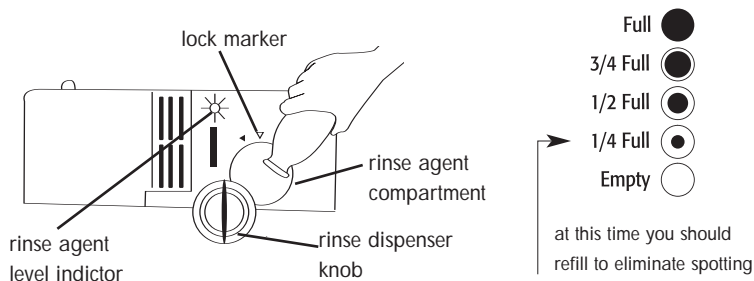

**Note:** A full dispenser should last approximately one month. If you want to adjust the amount of rinse agent dispensed, the dispenser has 1 to 6 levels that you can adjust to. Simply rotate the dial to your desire settings.

### Checking water temperature

- The minimum incoming temperature must be at 120°F/49°C in order for the detergent to dissolve properly.

If you are unsure of the temperature of your hot water:

1. Open the hot water faucet and let it run for a minute and fill a glass.
2. Take a thermometer and check the temperature of the water.
3. If the temperature is below the recommended 120°F / 49°C, then you need to adjust the water temperature on your water heater in order to maintain that temperature level.

### Overflowing protection

- In case the water level is rising above the highest acceptable point, the security pressure switch will activate the drain pump automatically.

### Cycle selection chart

Turn the cycle control knob to the desired cycle. If the door is properly closed the cycle will start.

Turn the cycle knob to rinse and hold to use this feature. DO NOT activate the heated dry option while using this feature. Do not use detergent in this cycle.

	cycle	pre-wash	wash	rinse	main wash	purge *	final rinse	dry
Pre-wash	•	•	•	•	•	•	•	•
pots & pans		•	•	•	•	•	•	•
heavy wash			•	•	•	•	•	•
normal wash				•	•	•	•	•
rinse & hold						•		

- \* Small amounts of water run through the pump to remove soil particles.
- Shows what steps are there in each cycle. Cycle time includes dry time. Cycle time may be longer depending on the temperature of the water entering the dishwasher.

**Note: Cooler the water, longer the cycle time.**



### **Canceling a cycle**

A cycle can be cancelled at any time by slowly turning the cycle selector knob clockwise till the dishwasher starts to drain. After draining open the door and turn the selector knob to the off position.

### **Changing a cycle**

A cycle can be changed at any time by lifting door latch to stop the cycle. If desired, at this time change the heated dry option. Turn the selector knob to the required cycle. Turning the cycle selector knob can cause the detergent dispenser to release the detergent. Check the detergent dispensers. They must be filled for the new cycle. Close the door till it firmly latches. The dishwasher now starts a new cycle.

### **Drying**

During the drying cycle you will see steam escaping through the vent located on the upper left side of the dishwasher door. This is normal as heat dries the wash load.

**CAUTION: The vapor is hot. DO NOT touch the vapor or the vent during the drying process.**

### **Overfill protection float**

This protection float is situated in the front right corner of the dishwasher tub. It keeps the tub from over filling. Check under the float to remove objects that may prevent it from moving up or down.

## Dishwasher Safe or Hand Wash

Material type	Dishwasher Safe		Comments	Explanations
	yes	no		
Aluminum	x		Some restrictions apply. Read manufacturer's washing instructions before loading.	Materials such as anodized aluminum may fade or become dark in hot water temperature. Some discoloration may appear. Load aluminum items away from other type of materials items because they can cause gray or black marks.
Cast Iron		x	Not recommended - hand wash only, dry immediately after washing.	Iron will rust in water and the seasoning will be lost due to the hot water temperature.
Chinaware	x		Some restrictions apply. Read manufacturer's washing instructions before loading. Note: Only if stated "Dishwasher Safe" (Some restrictions apply.)	You can wash "Chinaware" items that are without decoration. You can wash "Chinaware" items with decoration protected by special type of "Glaze". Any type of "Pattern" on top of glaze with gold or silver lining or design may fade in hot water temperature. Load these type of items away from each other to avoid
Copper	x		Read manufacturer's washing instructions before loading.	Load cooper items away from stainless steel items. Do not mix cooper and silver items in the same basket. They can easily discolor.
Crystal		x	Not recommended - hand wash only, dry immediately after washing.	Certain type of "Lead Crystal" may etch in high hot water temperature. Do not wash "Antiques" and "Very Delicate" items in the dishwasher. Crystal Items are recommended to be washed in low temperature setting. When loading, make sure they are securely in place to avoid falling over and knocking against other dishware items during the wash process.

## Dishwasher Safe or Hand Wash (continued)

Material type	Dishwasher Safe		Comments	Explanations
	yes	no		
Dirilyte (gold colored flat ware)		x	Not recommended - hand wash only, Read manufacturer's washing instructions before loading.	These items may become discolored.
Disposable Plastic		x	Not recommended - hand wash only, Read manufacturer's washing instructions before loading.	These items are not made for machine wash.
Glassware	x		Some exceptions and restriction apply. Read manufacturer's washing instructions before loading.	You may wash some glassware items to avoid stains. Empty liquids such as juice, soup, soda, coffee or tea from glasses and cups before loading.
Knives		x	Not recommended - hand wash only in cold water. Note: Sharp knives can become dull in hot water temperature. Read manufacturer's washing instructions before loading.	Sometimes the knife "Handle" (wood or other type of materials) may crack, loosen or wear out in hot water temperature.
Lead Crystal		x	Not recommended - hand wash only. Read manufacturer's washing instructions before loading.	These items may "Etch" if machine washed.
Non-Dishware	x		Some exceptions and restriction apply. Read manufacturer's washing instructions before loading. Note: Only if stated "Dishwasher Safe".	Never machine wash items such as electronic "air cleaners/filters" of any kind of small electronics/appliances.
Non-Stick Coatings	x		Not recommended - hand wash only. Read manufacturer's washing instructions before loading.	After wash, it is recommended that you wipe off the non-stick surface area with vegetable oil to maintain its non-stick quality.
Pewter		x	Not recommended - hand wash only. Read manufacturer's washing instructions before loading.	This will stain or discolor if machine washed.

## Dishwasher Safe or Hand Wash (continued)

Material type	Dishwasher Safe		Comments	Explanations
	yes	no		
Plastic	x		Only if stated "Dishwasher Safe". Read manufacturer's washing instructions before loading.	Place plastic items away from sharp items to avoid damage. It is recommended to place plastic items on the top rack. Do not heat dry. Do not wash "Disposable" plastic items.
Silver & Silver Plated	x		Note: Rinse these items immediately. If you are going to wash them later because acidic or salty foods may stain if left on for long time.	Do not place silverware and stainless steel items in the same basket. Silverware items may get damaged if they come in contact with stainless steel items.
Stainless Steel	x		Note: Rinse these items immediately if you are going to wash them later because acidic or salty foods may stain if left on for a long time. Note: Do not mix stainless and silverware items. Read manufacturer's washing instructions before loading.	Do not place silverware and stainless steel items in the same basket. Silverware items may become damaged if they come in contact with stainless steel items. Do not load different types of "Stainless" items in the same load/basket.
Metal		x	Not recommended. Note: It will rust. Read manufacturer's washing instructions before loading.	Do not wash "Metal Tin" in the dishwasher.
Wood		x	Not recommended. Note: Only if stated "Dishwasher Safe" Read manufacturer's washing instructions before loading.	Wood may crack or lose its shape in machine wash due to the hot water temperature condition.

# Care & Cleaning of Your Dishwasher

## General cleaning and maintenance

- Do not use abrasive, harsh cleaners, solvents, concentrated detergents or metal scouring pads to clean the inside of dishwasher.
- Use warm soapy water with a soft brush or a piece of cloth to clean the interior of a tub.
- Clean around the tub gasket with a damp cloth.
- When cleaning the control panel, use a slightly dampened cloth to wipe. Then dry thoroughly.
- When cleaning the door, use slightly soapy water with a soft piece of cloth.
- Do not use any sharp objects that can scratch the cabinet surface.

## Preventing your dishwasher from freezing

To protect your dishwasher if it is left in an unheated place during the winter.

- Shut off electrical power to the dishwasher.
- Turn off the water supply and disconnect the water inlet line from the water valve.
- Do not install or operate your dishwasher where the temperature is below freezing.
- If you receive a delivery of a dishwasher when the outside temperature is below freezing, do not operate it until the dishwasher has warmed to room temperature.

## Storage of your dishwasher in a cold environment

- You must store the dishwasher at room temperature.

## Drain Air Gap

Some states or local plumbing codes require the addition of a drain air gap between the built in dishwasher and the drain. If the drain is clogged the air protects the dishwasher from water backing up into it.



The drain air gap is usually located on the top of the sink or the counter top near the dishwasher.

# Troubleshooting

## **Dishwasher does not work**

- Check if the circuit breaker needs to be reset or if the fuse needs to be replaced.
- Check if the unit is in "OFF" mode.
- Check if the door is open. You may need to close the door properly.

## **Dishware and glassware/flatware are cloudy and not properly cleaned**

- Use of old or poor detergent.  
You need to make sure that detergent is fresh.
- The water may be hard in your area.  
You may need to install a water softener.
- Spray arm may be blocked.  
You may need to rearrange dishware and utensils.
- Water pressure may be low.  
You may need to adjust the water pressure.  
Make sure it is between 20 to 120 (PSI).
- Water temperature may be lower than what is recommended.  
(120 Degree F / 49 Degree C) You may need to adjust the water temperature on your water heater.
- Overloading of dishware.  
You may need to rearrange or remove some dishware from the load.
- (May have selected wrong cycle.) Inappropriate cycle selection.  
You may need to select the proper cycle.

## **Dishes are not dry**

- Low water temperature. You may need to regulate the water temperature to 120°F / 49°C or select Heated Dry option.
- Make sure the rinse agent dispenser is filled and the proper amount is used.
- Avoid nesting and do not overload.
- Load items in a tilted position if possible so the water will run off easily.
- Dishware washed in higher temperatures will dry faster.
- Some plastic materials may need to be towel dried.

### Dishware is chipped

- This is due to poor loading or overloading. You need to be careful when loading. Do not overload. You need to place the glassware securely against the pins. Make sure delicate items are on the side rack. We recommend that fine chinaware or crystal items be hand washed.
- Do not jam the glassware items together when loading.
- Place delicate items on the upper rack.
- Move racks slowly in and out to avoid slamming the dishware items together.
- Make sure all dishware and glassware items are securely in place when loading to avoid falling over or striking against each other.

### Noise

Some of the sounds you will hear are normal.

- You will hear the sound of the water fill and rinse.
- You will hear the drain pump motor operation to pump water out.
- You will hear the motor stopping at the end of the cycle.
- If some utensils are not secure in the rack, you will hear that they are being tossed around the tub.

### Over Sudsing

This is due to the use of regular hand washing detergent.

Detergent used should be for "Automatic Dishwasher Use". You must use the proper detergent for best dishwashing results.

### Dishware Odor

- This is due to an incomplete cycle.  
You need to allow the cycle to be fully completed.
- New scented detergent used.  
This is normal because different types of detergents may have different fragrances.

### Etching

- Too much detergent used.  
Use the appropriate amount of detergent. Reduce the amount of detergent used per load.
- The water temperature is too hot.  
You need to lower the water temperature.
- Use of old detergent.  
Read the expiration date. Avoid using old detergent. Use only fresh detergent.
- Do not pre-rinse the dishes.  
Simply scrape off large food particles

**Stained interior tub**

- Some detergents contain colorant known as "pigments" or "dyes" that will discolor the tub with extended use. You need to change the detergent to one without a colorant. Read the label carefully before using the detergent.
- Some acid based and paste based foods may discolor the tub. Use of the rinse cycle may help to decrease the level of staining.

**Spots & filming found on flatware/glassware**

This is due to:

- Use of too little detergent.
- Low incoming water temperature and pressure.
- Improper loading.
- Use of old, moist and damp powder detergent.
- Hard water in your area.

## Water

**Draining Problem**

- Check the level of the drain hose. The drain hose should be positioned above the drain in order to drain properly. Make sure it is on a high drain loop (20") above the sub floor or floor.
- If the drain hose is bent or shrunken, it may affect water draining.
- If water can not be drained out smoothly, the dishwasher operation will be affected and it may stop in the middle of the cycle.
- Make sure that the wash cycle is fully completed before you opened the dishwasher door.
- Make sure that the air gap is not blocked.
- If the unit is connected to a garbage disposer, make sure that it is not full. If it is, you need to empty it.
- Check for any type of blockage near the drain.
- If the water backs up into the sink, you need to check the garbage disposer and the trap for blockage.
- It is normal to find some water in the sump area near the drain.



**Dishwasher is leaking**

- Dishwasher is not properly leveled.  
You need to place the dishwasher on a flat hard surface. Avoid an uneven surface.
- Make sure the dishwasher is properly leveled. (See the installation instructions)
- Do not overfill the detergent or the rinse agent dispenser because it will cause over sudsing and overflowing.
- Do not use regular type hand or dish washing detergent in the detergent dispenser. These types of detergents are not recommended for dishwasher use.

**Dishwasher will not fill**

- Check the water supply.  
Make sure that the water supply is in "ON" position.
- Check water pressure. Make sure the water pressure is at the proper level. (Between 20 – 120 PSI)
- Is the overfill protection float able to move up and down freely. If not, press down to release.

**Detergent found in the compartment**

- Do not load items too close to the detergent compartment. This may block the automatic release of the detergent.
- Do not use old or caked/dried detergent in the compartment because it will not dissolve properly and will leave a sandy residue on dishware.
- Is the cycle complete? The cycle may not be complete.

**Dishwasher is running for too long**

- The temperature of incoming water is below 120°F. Raising your water heater setting will help to shorten the time of operation.
- Call the Haier Customer Satisfaction Center if this does not resolve the problem.

# Limited Warranty

## In-Home Service

### 1 Year Warranty

For 12 months from the date of original retail purchase, Haier will repair or replace any part free of charge that fails due to a defect in materials or workmanship, including labor.

### 2 Years Limited Warranty Water Distribution System (Parts Only)

For 24 months from the date of original retail purchase, Haier will replace any parts in the water distribution system which fail due to manufacturing defect. This includes the pump, motor, lower wash arm, middle wash arm and the wash tower upper sprayer with associated supply tube and filters.

NOTE: Associated outside inlet and drain plumbing parts are not covered by this warranty.

### Coated Racks (Parts Only)

For 24 months from the date of original retail purchase, Haier will replace coated upper or lower rack that peels or rusts due to a manufacturing defect.

### Rotary or Electromechanical Control (Parts Only)

For 24 months from the date of original retail purchase, Haier will replace rotary/electromechanical control that fails due to a manufacturing defect.

NOTE: This warranty commences on the date the item was purchased and the original purchase receipt must be presented to the authorized service representative before warranty repairs are rendered.

### Exceptions: Commercial or Rental Use Warranty

90 days labor from date of original purchase  
90 days parts from date of original purchase  
No other warranty applies

### For Warranty Service

Contact your nearest authorized service center. All service must be performed by a Haier authorized service center. For the name and telephone number of the nearest authorized service center please call 1-877-337-3639.

Before calling, please have the following information available:

Model number and serial number of your

appliance (found on the door of the unit on the left hand side).

The name and address of the dealer you purchased the unit from and the date

of purchase.

A clear description of the problem.

A proof of purchase (sales receipt).

This warranty covers appliances within the continental United States, Puerto Rico and Canada. What is not covered by this warranty:

Replacement or repair of household fuses, circuit breakers, wiring or plumbing.

A product whose original serial number has been removed or altered.

Any service charges not specifically identified as normal such as normal service area or hours.

Damage to dishware.

Damage incurred in shipping.

Damage caused by improper installation or maintenance.

Damage from misuse, abuse accident, fire, flood, or acts of nature.

Damage from service other than an authorized Haier dealer or service center.

Damage from incorrect electrical current, voltage or supply.

Damage resulting from any product modification, alteration or adjustment not authorized by Haier.

Adjustment of consumer operated controls as identified in the owners manual.

Hoses, knobs and all attachments, accessories and disposable parts.

Labor, service transportation, and shipping charges for the removal and replacement

of defective parts beyond the initial 12-month period.

Damage from anything other than normal household use.

Any transportation and shipping charges.

**THIS LIMITED WARRANTY IS GIVEN IN LIEU OF ALL OTHER WARRANTIES, EXPRESSED OR, INCLUDING THE WARRANTIES OF MERCHANTABILITY AND FITNESS FOR A PARTICULAR PURPOSE**

The remedy provided in this warranty is exclusive and is granted in lieu of all other remedies.

This warranty does not cover incidental or consequential damages, so the above limitations may not apply to you. Some states do not allow limitations on how long an implied warranty lasts, so the above limitations may not apply to you.

This warranty gives you specific legal rights, and you may have other rights, which vary, from state to state.

Haier America  
New York, NY 10018

# IMPORTANT

## **Do Not Return This Product To The Store**

If you have a problem with this product, please contact  
the "Haier Customer Satisfaction Center" at 877.337.3639.  
DATED PROOF OF PURCHASE REQUIRED FOR WARRANTY SERVICE

# IMPORTANT

## **Ne pas Réexpédier ce Produit au Magasin**

Pour tout problème concernant ce produit, veuillez contacter le service des consommateurs  
"Haier Customer Satisfaction Center" au 1-877-337-3639.  
UNE PREUVE D'ACHAT DATEE EST REQUISE POUR BENEFICIER DE LA GARANTIE.

# IMPORTANTE

## **No regrese este producto a la tienda**

Si tiene algún problema con este producto, por favor contacte  
el "Centro de Servicio al Consumidor de Haier" al 1-877-337-3639 (Válido solo en E.U.A).  
NECESITA UNA PRUEBA DE COMPRA FECHADA PARA EL SERVICIO DE LA GARANTIA

# Haier®

Made in China  
Fabriqué en Chine  
Hecho en China

Haier America  
1356 Broadway  
New York, NY 10018

Printed in China

## Free Manuals Download Website

<http://myh66.com>

<http://usermanuals.us>

<http://www.somanuals.com>

<http://www.4manuals.cc>

<http://www.manual-lib.com>

<http://www.404manual.com>

<http://www.luxmanual.com>

<http://aubethermostatmanual.com>

Golf course search by state

<http://golfingnear.com>

Email search by domain

<http://emailbydomain.com>

Auto manuals search

<http://auto.somanuals.com>

TV manuals search

<http://tv.somanuals.com>