

Haier

DISHWASHER OPERATION MANUAL

EN

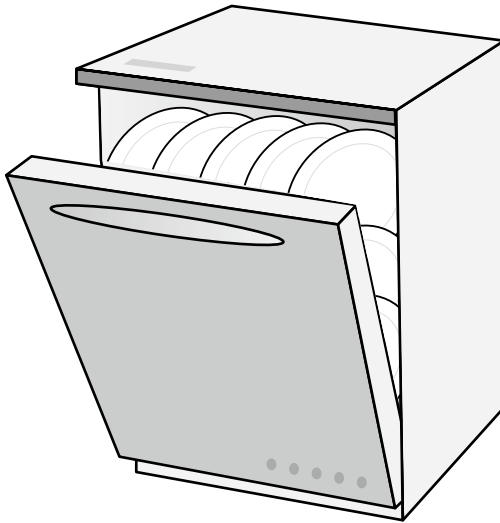

HDW12-SFE1 Series

- PLEASE READ THIS OPERATION MANUAL BEFORE USING THE DISHWASHER.

0120500875

Safety information	2
Installation	4
Getting to know your dishwasher	6
How to fill rinse aid	7
How to fill the detergent dispenser	8
Not suitable for the dishwasher	9
Arranging crockery, glasses, etc. in the dishwasher	10
Programme overview	12
Washing dishes	13
How to keep your dishwasher in shape	15
Care and maintenance	16
Trouble Shooting	17
Technical data	21
Important information	21

At time of delivery

- Check packaging and dishwasher immediately for signs of transport damage. If the appliance is damaged, do not put it into use but contact your supplier or customer service without delay.
- Please dispose of packaging materials properly.

During installation

- Site the dishwasher and connect it up in accordance with the installation instructions.
- The dishwasher must not be connected to the electricity supply while installation is being carried out.
- Ensure that the domestic wiring is properly earthed.
- The mains electricity supply must conform to the details shown on the dishwasher nameplate.
- Do not connect the dishwasher to the electricity supply via an extension cable.
- After the appliance has been installed, the mains plug should still be easily accessible.
- During installation, the power supply cord must not be excessively or dangerously bent or flattened.

During normal use

- The dishwasher must only be used by adults for the washing of household dishes and cooking utensils.
- This appliance cannot be installed outdoor, not even if the area in which it is installed is covered by a roof; it is also very dangerous to leave it exposed to the rain and elements.
- Do not place any heavy objects or stand on the door when it is open. The appliance could tip forward.
- The water inside the dishwasher is not suitable for drinking.
- Do not use solvents of any kind inside your dishwasher. They could cause an explosion danger. Open the door very carefully if the dishwasher is operating. There is a risk of water squirting out.
- Do not touch the heating element during or after a wash cycle.
- Fundamental rules to follow when using the appliance:
 - Never touch the dishwasher when barefoot or with wet hands or feet;
 - We discourage the use of extension cords and multiple sockets;
 - If the appliance is not operating properly or maintenance must be performed, disconnect the appliance from the power supply.

If your family includes children

- The appliance is not intended for use by young children or infirm persons without supervision.
- Young children should be supervised to ensure that they do not play with the appliance.
- Keep detergents out of the reach of children, who must also be kept away from the dishwasher when it is open.

If a fault occurs

- If the appliance malfunctions, turn off water supply to the appliance and disconnect the power supply turn off and the plug from the wall socket. Then, consult the section entitled, "Fault finding" .If you cannot solve the problem, contact a service center.
- Only specialised personnel are authorised to make repairs.
If the supply cord is damaged, it must be replaced by the manufacture, its service agent of similarly qualified persons in order to avoid a hazard.
- To maintain the EFFICIENCY and SAFETY of this appliance,we recommend:
 - call only the Service Centers authorized by the manufacturer, or the approved Service agents.
 - always use original Spare Parts.

When disposing of old appliances

- Appliances which are no longer being used must be made inoperable by cutting the power supply cord and removing the door lock.
- Take the appliance to a designated waste disposal center.



Dangerous voltage



Warning

Children could get locked in the appliance (risk of suffocation) or get stuck in other positions. Therefore: Remove the mains plug, cut the mains wire and set aside. Damage the door lock so that the door can no longer be closed.

Positioning the appliance

Positioning the appliance in the desired location. The back of the appliance should rest against the wall, and the sides, along the adjacent cabinets or wall. The dishwasher is equipped with water supply and drain hoses that can be positioned to the right or the left to facilitate proper installation.

Levelling the appliance

Once the appliance is positioned, adjust the feet (screwing them in or out) to adjust the dishwasher, making it level. The appliance should not be inclined more than 2°. If the appliance is level, it will help ensure proper performance.

Cold water connection

Connect the water supply hose to a threaded 3/4 (gas) connector, making sure that it is fastened tightly in place (see fig.A).

If the water pipes are new or have not been used for an extended period of time, let the water run to make sure that the water is clear and free of impurities. If this precaution is not taken, there is a risk that the water inlet can get blocked and damage the appliance.

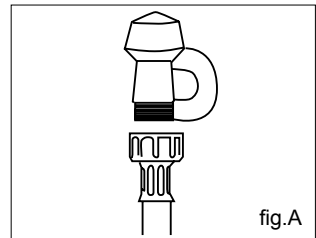

Warning

The appliance is to be connected to the water mains using new hose-sets and that old hose-sets should not be reused.

Drain hose connection

Insert the drain hose into a drain pipe with a minimum diameter of 4cm, or let it run into the sink, making sure to avoid bending or crimping it. If necessary, fit a syphon trap (U-bend) with a connecting piece for the electrical drain hose (fig.B). The free end of the hose must be at a height between 40 and 100 cm and must not be immersed in water.

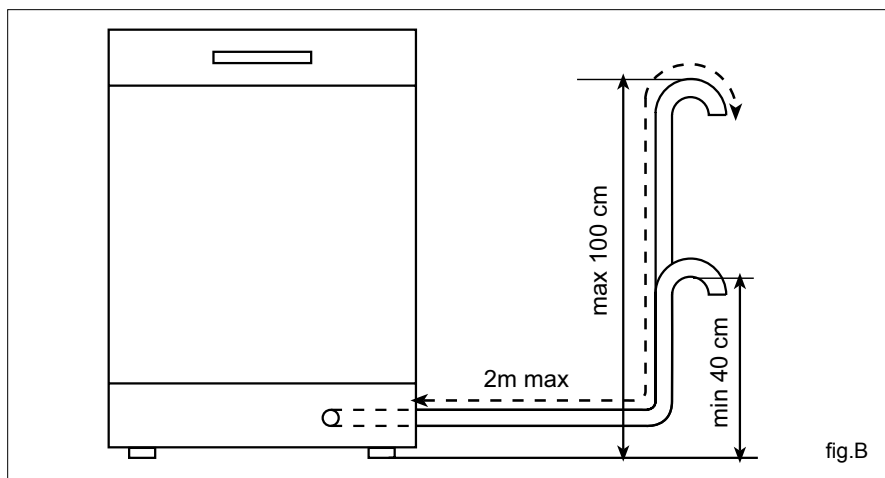

Attention:

The connecting piece for syphon trap (U-bend) must be securely fastened to the wall to prevent the drain hose from moving and allowing water to spill outside the drain.

Electrical Connection

After making sure that the voltage and frequency values for the current in the home correspond to those on the rating plate (located on the stainless steel inner door of the appliance) and that the electrical system is correct for the maximum voltage on the rating plate, insert the plug into an electrical socket which is earthed properly (the earthing of the appliance is a safety requirement mandated by law).

If the electrical socket to which the appliance must be connected is not appropriate for the plug, replace the whole cable, rather than using adaptors or the like as they could cause overheating and burns.



Caution:

The dishwasher plug must be accessible even when the appliance is installed as a built-in unit so that maintenance can be done safely.

Close-up view (control panel)

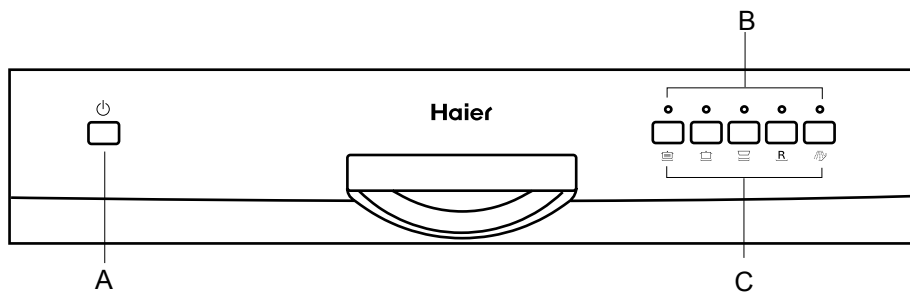

- A** ON-OFF Button
- B** Programme Indicator
- C** Programme Button

Dishwasher interior

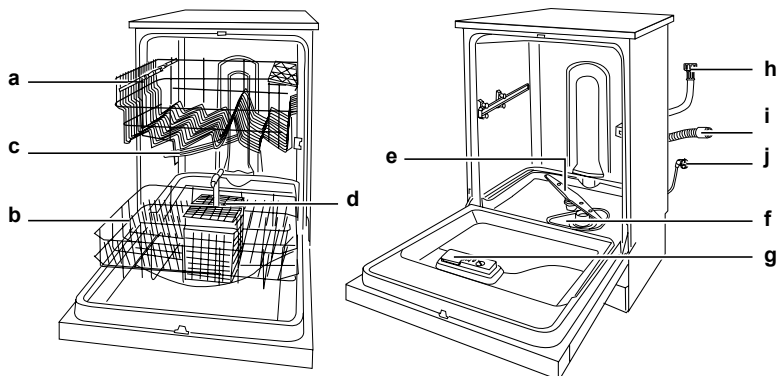

- a** Upper Rack
- b** Lower Rack
- c** Top Spray Arm
- d** Silverware Basket
- e** Bottom Spray Arm
- f** Washing Filter
- g** Detergent and Rinse Aid Dispenser
- h** Water Inlet Hose
- i** Drain Hose
- j** Power Supply Cord

Rinse aid

This product makes dishes sparkle and helps them to dry without spotting. The dispenser is located on the inside panel of the door .

Loading the rinse aid

Regardless of the type of detergent dispenser installed on your appliance, you must proceed as indicated below when loading the rinse aid.

To open the dispenser, turn the "1" cap in an anti-clockwise direction and then pour in the rinse aid, making sure not to overfill. The amount of rinse aid used for each cycle can be regulated by turning the "2" dose adjuster, located beneath the "1" cap, with a screwdriver. There are 6 different settings; the normal dosage setting is 3.

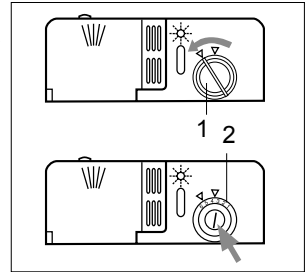

Important

Proper dosage of the rinse aid improves drying. If drops of water remain on the dishes or spotting occurs, the dosage adjuster should be turned to a higher setting. If the dishes have white streaks, turn the dosage adjuster to a lower setting.

Detergent

Detergent specifically intended for use with dishwashers must be used. The dispenser must be refilled before the start of each wash cycle following the instructions provided in the "Programme overview". The detergent dispenser is located on the inside panel of the door.

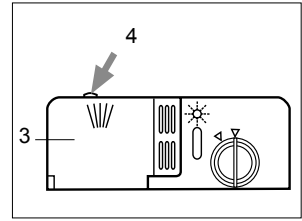

Loading the detergent

- To open the "3" cover on the dispenser, press the "4" button.
- The detergent for the wash cycle should be poured into the "5" compartment.
- The detergent for the pre-wash cycle should be poured into the "6" compartment.
- After the detergent has been placed in the dispenser, close the cover and press down until it clicks in place.

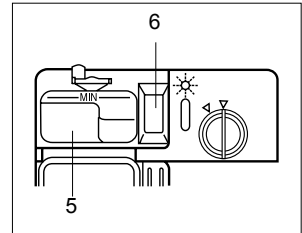

Notice:

To facilitate closing the cover, remove any excess detergent on the edges of the dispenser.

What you should not put into the dishwasher

Cutlery and tableware manufactured in whole or part from wood. They become faded and unsightly in appearance. Furthermore, the adhesives that are used are not suitable for the temperature that occur inside the dishwasher. Delicate decorative glassware and vases, special antique or irreplaceable china. The decorative patterns on such items will not be dishwasher-proof.

Plastic objects that are not resistant to hot water, copper and pewter utensils are also not suitable. Decorative patterns printed or painted onto the surface of crockery, glasses, etc., aluminium and silver items tend to become discoloured or faded if washed in the dishwasher. Some types of glass can become opaque in appearance after they have been washed many times in a dishwasher. Highly absorbent materials, such as sponges and towels, should never be placed in the dishwasher.

Our recommendation

In future, only purchase table or kitchenware that has been confirmed as being dishwasher-proof.



Important

Dishes or cutlery that have been soiled by tobacco ash, wax, lubricating grease or paint, should not be put in the dishwasher.

Damage to glassware and other dishes

Possible causes

- type of glass or manufacturing process
- chemical composition of detergent
- water temperature and duration of dishwasher programme.

Suggested remedy

- Use glassware or porcelain dishes that have been marked 'dishwasher-proof' by the manufacture.
- Use a mild detergent that is described as 'kind to dishes'. If necessary, seek further information from detergent manufacturers.
- Select a programme with a low temperature and a short duration as possible.
- To prevent damage, take glass and cutlery out of the dishwasher as soon as possible after the programme has ended.

Arranging crockery, glasses, etc. in the dishwasher en

Before placing the dishes in the dishwasher, remove larger food particles to prevent the filter from becoming clogged, which results in reduced performance.

If the pots and pans have baked-on food that is extremely hard to remove, we recommend that they are soaked before washed. This will eliminate the need for extra wash cycles.

Pull out the rack to load the dishwasher.

How to use the lower rack

We recommend that you place the most difficult to clean items on the bottom rack: pots, pans, lids, serving dishes and bowls, as shown in the figure to the right.

It is preferable to place serving dishes and lids on the sides of the racks in order to avoid blocking the rotation of the top spray arm.

- Pots, serving bowls, etc. must always be placed face down(see fig.D) .
- Deep pots should be slanted to allow the water to flow out.
- The silverware basket can be doubled (see fig.E) so that only one section may be used when the silverware load is light. This also makes space for additional pots and pans and it can also be placed in the upper rack.
- Silverware should be placed in the silverware basket with the handles at the bottom; if the rack has side baskets, the spoons should be located individually into the appropriate slots. Especially long utensils should be placed in the horizontal position at the front of the upper rack.

Normal daily load

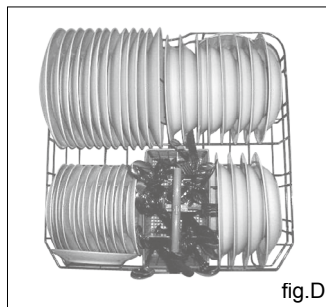

fig.D

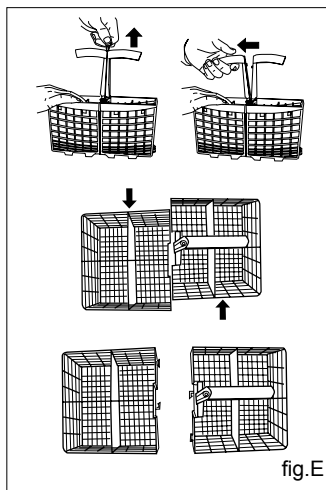
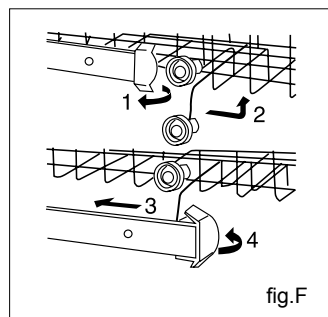

fig.E

How to use the upper rack

The upper rack is designed to hold more delicate and lighter dishware, such as glasses, cups and saucers, plates, small bowls and shallow pans (as long as they are not too dirty).

- Position the dishes and cookware so that they do not get moved by the spray of water.
- The upper rack can be adjusted for height using the levers located on both sides of the rack (see fig.F).







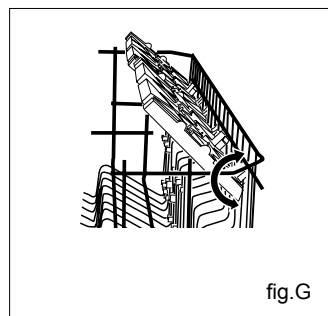

Adjust the upper basket to the higher level and you have more space to accommodate those taller pans and trays in the bottom basket.

Shelf

Lean tall glasses and those with long stems against the shelf-not against other items to be washed.

Place glasses, cups and small bowls on the additional cup rack. The additional cup rack can be swivelled in or out as required(see fig.G).



Wash programme	Type of food remains	Amount of food remains	Condition of food remains	Description of cycle	Detergent		Rinse Aid
					Prewash	Extended Wash	
 Intensive Wash	Soups, casseroles, sauces, potatoes,	a lot	stuck on hard	Pre-wash with warm water. Extended wash . Rinses with cold water. Rinse with hot water. Drying.	5g	25g	●
 Normal (AS/NZS 2007)	pasts, rice, eggs, roast or fried food.			Pre-wash use cold water. Extended wash . Rinse with cold water. Rinse with hot water. Drying.	5g	25g	●
 Light	Soups, potatoes, pasta, rice, eggs, roast or fried food.	a little	loosely attached	Pre-wash use cold water. Extended wash . Rinse with cold water. Rinse with hot water. Drying.	5g	25g	●
 Rapid	Coffee, cakes, milk, sausage, cold drinks, salads	Very little	loosely attached	Short wash. Cold rinse. Hot rinse.	—	15g	●
 Pre-Rinse	Rinse off if the dishes have been stacked for several days in the dishwasher prior to washing.			Short cold wash to prevent food residue from drying on the dishes .	—	—	—

Programme selection

The most appropriate programme can be identified by comparing the type of crockery, cutlery, etc., as well as the amount and condition of food remains, with the details contained in the wash cycle table. The corresponding programme sequence, duration and consumption details are shown in the right half of the overview. For example:

Use the “Normal”  programme for dishes and utensils which have plenty of food remains stuck on hard.

Earn savings

If only a small number of dishes have been loaded into the dishwasher, selecting a programme that operates at the next lowest temperature which should be sufficient.

Programme data

The stated programme data are based on standard operating conditions. The values can vary considerably according to:

- different amounts of dishes
- temperature of mains water supply
- pressure of mains water supply
- ambient temperature
- fluctuations in mains voltage
- machine-related factors (e.g. temperature, water volume,...)

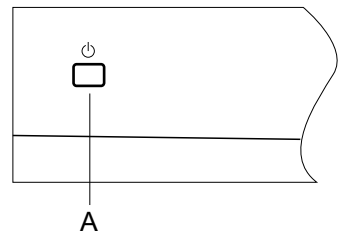

Switching the dishwasher ON

- Load the appliance and turn on the tap.
- Close the door, and set On-Off button “A”.
- Press the programme button “C” to select the programme you wish, and the corresponding programme indicator “B” light.

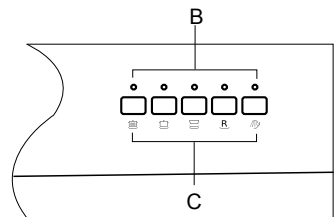

End of programme

- Six beeps will indicate that the wash cycle has finished, the programme indicator light.

Switching the dishwasher OFF

Several minutes after the programme has ended:

- Set On-Off button to Off
- Open the door .
- Turn the water tap off.
- Remove dishes, etc. when they have cooled down.



Notice:

When the appliance is already underway press the button "B" for 3 seconds, all of the settings will be cancelled.

Interrupting the programme

- Open the door.

Caution! There is a risk of water squirting out from inside the appliance. Do not open the door fully until spray arm has stopped rotating.

- If the appliance has already heated up or the hot water was switched ON and then the appliance door opened, leave the door ajar for several minutes and then close. Otherwise, the appliance door may open due to expansion.



Notice:

Interrupt or cancel a programme in progress **ONLY** when absolutely necessary.

Cancelling or modifying a cycle while underway

- A cycle that is underway can be modified if it has only been running for a short time. Otherwise, the detergent may have already been used, and the appliance may have already drained the wash water. If this is the case, the detergent dispenser must be refilled (see the paragraph entitled, "Loading the detergent ").
- To modify a cycle that is already underway, follow the instructions contained in the paragraph entitled "Reset drain function", and select the programme you wish (see the paragraph entitled, "Switching the dishwasher ON").

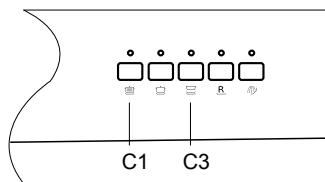

Reset drain function

You can use Reset drain function to stop the washing cycle under running by pressing and holding the "C1" and "C3" for 3 seconds, and the appliance will stop after a few minutes drain phase.

Download from [Www.Somanuals.com](http://www.Somanuals.com). All Manuals Search And Download.

After Every Wash

After every wash, turn off the water supply the appliance and leave the door slightly ajar so that moisture and odors are not trapped inside.

Remove the plug

Before cleaning or performing maintenance, always switch off the remove the plug from the socket. Do not run risks.

No solvents or Abrasive Cleaning Products

To clean the exterior and rubber parts of the dishwasher, do not use solvents or abrasive cleaning products. Rather, it is recommended that you use only a cloth and warm soapy water.

To remove spots or stains from the surface of the interior, use a cloth dampened with water and a little white vinegar, or cleaning product made specifically for dishwashers.

Moving the Appliance

If the appliance must be moved, try to keep it in a vertical position. If absolutely necessary, it can be positioned on its back.

Seals

One of the factors that cause odors to form in the dishwasher is food that remains trapped in the seals. Periodic cleaning with a damp sponge will prevent this from occurring.

The door should not be left in the open position since this could present a tripping hazard.

When You Go on Holiday

When you go on holiday, it is recommended that you run a wash cycle with the dishwasher empty and then remove the plug from the socket, turn off the water supply and leave the door of the appliance slightly ajar. This will help the seals last longer and prevent odors from forming within the appliance.

Regular inspection and maintenance of your appliance helps to prevent problems from occurring. This saves time and aggravation. You should therefore carefully inspect the inside of your dishwasher from time to time.

Overall condition of appliance

- Check that no grease or scale has accumulated on the inside of the dishwasher.
- If you discover any deposits:
 - Clean the interior of the dishwasher thoroughly with a detergent solution.

Filters

The filters “7”, “8” prevent larger particles of food in the water from reaching the pump. These particles may occasionally block the filters.

- When the appliance has finished washing, check the filters for particles of food and, if required, clean.
- After undoing the coarse micro-filter “7”, the filter unit “8” can be removed. Remove any particles of food and rinse the filters under running water.
- Insert the filter unit “8” and tighten the coarse micro-filter.

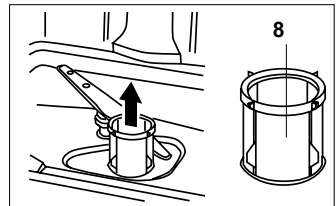
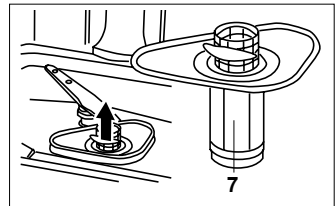

Spray arms

Lime and remnants of food in the washing water can block the nozzles in the spray arms “9” and “10” and the arm mountings.

- Inspect the nozzles in the spray arms for blocked holes due to remnants of food.
- If necessary, pull the lower arm “10” upwards and lift it off.
- Unscrew the upper spray arm “9”.
- Clean both spray arms under running water.
- Refit the spray arms. Ensure that the lower arm has locked into place and the upper one is screwed tight.

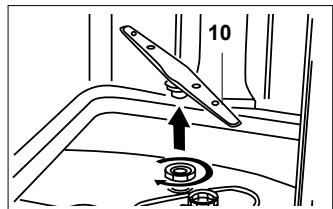
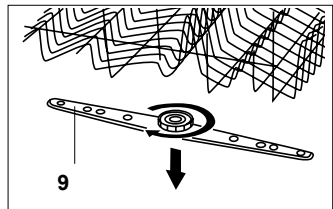

Resolving minor problems yourself

Experience has shown that you can resolve most problems that rise during normal daily usage yourself, without having to call out a service engineer. Not only does this save costs, but it also means that the appliance is available for use again that much sooner. The following list of common occurrences and their remedies should help you identify the causes of most problems.

Problems...

...when the appliance is switched on

Appliance does not start up

- Fault with fuse in mains electricity supply.
- Plug not inserted in wall socket.
- Appliance door not closed properly.
- Programme button has not been pressed.
- Water tap not turned on.
- Blocked strainer in water intake hose.
 - The strainer is situated in the Aquastop or supply-hose connection.



Caution

Do not forget that repairs should only be carried out by a qualified specialist. Improper repairs can lead to considerable equipment damage as well as danger to the user.

...with the appliance itself

When the programme indicators “ B1,B4” blink.

Have you checked whether:

- the drain hose is too low.

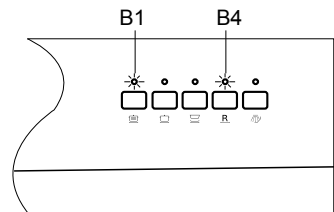

When the programme indicators “ B1,B3,B4” blink.

Have you checked whether:

- the drain hose is crimped or bent.
- the drain hose is too high.

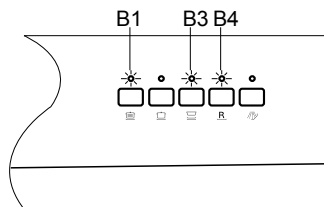

When the programme indicators “B1,B2,B3” blink.

Have you checked whether:

- the water is turned on and the hose is connected properly;
- the water supply to the house is on and has sufficient pressure;
- the water supply hose is crimped or bent;
- the filter for the water supply hose is clogged.
- the drain hose is too low.

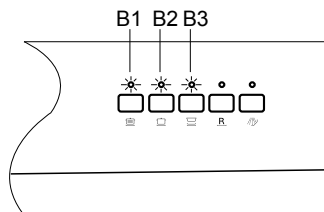

If you take all these checks and the dishwasher still does not function or your dishwasher have any other error display, you can power the dishwasher OFF, and wait a few minutes. You can power the dishwasher on, try it again , if the dishwasher still does not function and/or the problem persists, contact the nearest authorised service center and provide them with the following information:

- the nature of the problem.
- the model type number (Mod...) And the serial number (S/N...), which are indicated on the plate located on the side of the inner part of the door.

Lower spray arm rotates with difficulty

- Spray arm is blocked by small items or food remains.

Lid in detergent compartment cannot be closed

- Detergent compartment has been overfilled.
- Mechanism is clogged with remnants of detergent.

Remnants of detergent stuck inside dispenser

- Compartment was damp when it was filled up with detergent. Compartment must be dry before detergent is added.

Water remains inside appliance after programme has ended

- Blockage or kind in drainage hose.
- Pump is jammed.
- Filters are blocked.
- The programme is still running. Wait for the programme to end .

...during washing

Unusual amount of foam is creased

- Normal washing up liquid has been poured into the rinse-aid container.
- Remove any spilled rinse aid with a cloth as it could otherwise lead to excessive foaming during the next washing cycle.

Appliance stops suddenly while washing is taking place

- Cut off electricity supply to appliance.
- Water supply has been interrupted.

Knocking sound can be heard while washing is taking place

- A spray arm is knocking against the dishes inside the appliance.

Rattling sound can be heard while washing is taking place

- Crockery has not been stacked properly inside the appliance.

Knocking sound coming from inlet valves

- This is caused by the way the water pipes have been laid and it has no effect upon the way the appliance functions. There is no remedy for this.

...with the dishes,cutlery, etc.

Remnants of food are stuck to the dishes, cutlery,etc.

- Dishwasher was not loaded properly. Jets of water could not reach all parts of the dishes, ect.
- Too many items in the rack.
- Items in the rack were touching each other.
- Not enough detergent was added to dispenser.
- Selected wash programme was not intensive enough.
- Rotation of spray arm was obstructed by dishes, etc.
- N ozzles in spray arm are blokcked by remnants of food.
- Filters are blocked.
- Filters have been incorrectly fitted.
- Waste-water pump is jammed.

Plastic items are discoloured

- Not enough detergent was added to dispenser.
- Detergent has insufficient bleaching properties. Use a detergent containing a chemical bleaching agent.

White stains are left on crockery, glasses have a milky appearance

- Not enough detergent was added to dispenser compartment.
- Amount of rinse-aid was set too low.

Dishes, cutlery, etc. have not been dried

- Selected programme did not include drying function.
- Amount of rinse-aid was set too low.
- Items were removed from dishwasher too soon.

Glasses have a dull appearance

- Amount of rinse-aid was set too low.

Tea stains or traces of lipstick have not been completely removed

- Detergent does not have a sufficient bleaching effect.
- Washing temperature was set too low.

Traces of rust on cutlery

- Cutlery is not sufficiently rustproof.

Glasses become clouded and discoloured; coating cannot be wiped off

- Unsuitable detergent was used.
- Glasses are not dishwasher-proof.

Smears left behind on glasses and cutlery; glasses have acquired a metallic appearance

- Amount of rinse-aid set too high.

Width	600 mm
Depth	600 mm
Height	850 mm
Capacity	12 standard place settings
Mains water pressure	0.03-1.0MPa
Power voltage	220-240V~ 50Hz
Maximum current intensity	10A
Total absorbed power	1950W

Important information

Notes on waste disposal

Old appliances still have some residual value. An environment-friendly method of disposal will ensure that valuable raw materials can be recovered and used again.

When an appliance has reached the end of its working life, unplug it from the mains. Cut through the mains cable and dispose of it together with the plug.

Destroy the door locking mechanism. This will ensure that children at play cannot become locked inside and are not exposed to the risk of suffocation.

Your new appliance was protected by suitable packaging while it was on its way to you. All materials used for this purpose are environment-friendly and can be recycled. Please make a contribution to protecting the environment by disposing of the packaging appropriately.

Do not allow children to play with any parts of the packaging. There is a risk of suffocation by the cardboard boxes and the plastic wrapping.

Up-to-date information concerning options for disposal can be obtained from your retailer or local municipal administration.

General information

- Measures must be taken to ensure that built-under and built-in units that are subsequently re-sited as free-standing appliances cannot topple over. This can be achieved by bolting the dishwasher to the wall or fitting it under a continuous work surface which is screwed to the adjacent cupboards.

Information on comparability tests implemented in compliance with AS/NZS 2007

Appliance loaded in accordance with standard specifications.

Example of loaded dishwasher: See Fig 1 and 2

Capacity: 12 place settings

Comparability programme: Normal

Rinse-aid setting: 5

Detergent: 5g+25g

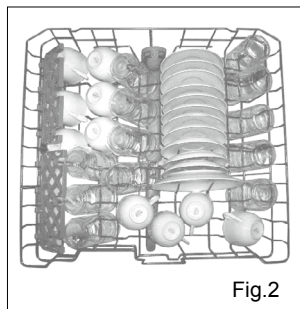
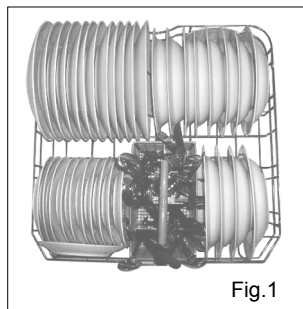

Height-adjustable top-basket must be inserted in the uppermost position.

When the programme is finished leave the door open 30° to improve the drying performance.

If the comparability tests do not comply fully with AS/NZS 2007, e.g., degree of soiling, type of dishes and cutlery, etc., contact the appliance manufacturer before starting the test.

Free Manuals Download Website

<http://myh66.com>

<http://usermanuals.us>

<http://www.somanuals.com>

<http://www.4manuals.cc>

<http://www.manual-lib.com>

<http://www.404manual.com>

<http://www.luxmanual.com>

<http://aubethermostatmanual.com>

Golf course search by state

<http://golfingnear.com>

Email search by domain

<http://emailbydomain.com>

Auto manuals search

<http://auto.somanuals.com>

TV manuals search

<http://tv.somanuals.com>