

# Haier

## TFT-LCD TV *OWNER'S MANUAL*

Please READ this manual carefully before operating your TV, and retain it for future reference.

# Haier

# Haier

### MODELS:

HL26B	HL26S
HL32B	HL32S
HL37B	HL37S
HL40B	HL42S
HL42B	

Haier



## WARNING

RISK ELECTRIC SHOCK  
DO NOT OPEN



WARNING : To reduce the risk of electric shock do not remove cover or back.  
No user-serviceable parts inside refer service to qualified service personnel.

Safety of operators has been taken into consideration at the design and manufacture phase, but inappropriate operation may cause electric shock or fire. To prevent the product from being damaged, the following rules should be observed for the installation, use and maintenance of the product. Read the following safety instruction before starting the operation.

The User Manual uses the following symbols to ensure a safe operation and prevent any damage to operators or properties:



**THIS SYMBOL INDICATES THAT HIGH VOLTAGE IS PRESENT INSIDE. IT IS DANGEROUS TO MAKE ANY KIND OF CONTACT WITH ANY INSIDE PART OF THIS PRODUCT.**



**THIS SYMBOL INDICATES THAT THERE ARE IMPORTANT OPERATING AND MAINTENANCE INSTRUCTIONS IN THE LITERATURE ACCOMPANYING THE APPLIANCE.**

## FCC STATEMENT

This equipment has been tested and found to comply with the limits for a Class B digital device, pursuant to Part 15 of the FCC Rule. These limits are designed to provide reasonable protection against harmful interference in a residential installation. This equipment generates, use and can radiate radio frequency energy and, if not installed and used in accordance with the instructions, may cause harmful interference to radio communications. However, there is no guarantee that interference will not occur in a particular installation. If this equipment does cause harmful interference to radio or television reception, which can be determined by turning the equipment off and on, the user is encouraged to try to correct the interference by one or more of the following measures:

- \*Reorient or relocate the receiving antenna.
- \*Increase the separation between the equipment and receiver.
- \*Connect the equipment into an outlet on a circuit different from that to which the receiver is connected.
- \*Consult the dealer or an experienced radio/TV technician for help.

This device complies with Part 15 of the FCC Rules. Operation is subject to the following two conditions: (1) This device may not cause harmful interference, and (2) this device must accept any interference received, including interference that may cause undesired operation.

### FCC CAUTION:

To assure continued compliance and possible undesirable interference, the provided ferrite cores must be used when connecting this plasma display to video equipment; and maintain at least 40cm spacing to other peripheral device.

### CANADIAN NOTICE:

This Class B digital apparatus complies with Canadian ICES-003.

# IMPORTANT SAFETY INSTRUCTIONS

Read all of the instructions before using this appliance. When using this appliance, always exercise basic safety precautions, including the following:

- 1) Read these instructions.
- 2) Keep these instructions.
- 3) Heed all warnings.
- 4) Follow all instructions.
- 5) Do not use this apparatus near water.
- 6) Clean only with dry cloth.
- 7) Do not block any ventilation openings. Install in accordance with the manufacturer's instructions.
- 8) Do not install near any heat sources such as radiators, heat registers, stoves, or other apparatus (including amplifiers) that produce heat.
- 9) Do not defeat the safety purpose of the polarized or grounding-type plug. A polarized plug has two blades with one wider than the other. A grounding type plug has two blades and a third grounding prong. The wide blade or the third prong are provided for your safety. If the provided plug does not fit into your outlet, consult an electrician for replacement of the obsolete outlet.
- 10) Protect the power cord from being walked on or pinched particularly at plugs, convenience receptacles, and the point where they exit from the apparatus.
- 11) Only use attachments/accessories specified by the manufacturer.
- 12) Use only with the cart, stand, tripod, bracket, or table specified by the manufacturer, or sold with the apparatus. When a cart is used, use caution when moving the cart/apparatus combination to avoid injury from tip-over.
- 13) Unplug this apparatus during lightning storms or when unused for long periods of time.
- 14) Refer all servicing to qualified service personnel. Servicing is required when the apparatus has been damaged in any way, such as power-supply cord or plug is damaged, liquid has been spilled or objects have fallen into the apparatus, the apparatus has been exposed to rain or moisture, does not operate normally, or has been dropped.
- 15) **WARNING-To Reduce The Risk Of Fire Or Electric Shock, Do Not Expose This Apparatus To Rain Or Moisture.** Apparatus shall not be exposed to dripping or splashing and no objects filled with liquids, such as vases, shall be placed on the apparatus.

PORTABLE CART WARNING  
(symbol provided by RETAC)



S3126A

## SAVE THESE INSTRUCTIONS

Thank you for using our Haier product. This easy-to-use manual will guide you in getting the best use of your product. Remember to record the model and serial number. They are on label in back of the unit.

---

Model number

---

serial number

---

Date of purchase

Staple your receipt to your manual. **You will need it to obtain warranty service.**

# Contents

Warning .....	2	<b>Time Menu</b>	
Safety Instructions .....	3	Date /Time setting.....	26
<b>Introduction</b>		Timer on setting.....	26
Controls .....	6	Timer offsetting.....	26
Connection Options .....	7	Sleep Timer setting.....	27
Universal Remote Controller .....	8	Time zone setting.....	27
<b>Installation</b>		Daylight Saving setting.....	27
Accessories .....	9	<b>Function Menu</b>	
Antenna Connection .....	9	Closed Captions.....	28
VCR Connection .....	10	CC mode.....	28
External A/V Source Setup .....	11	NTSC Caption.....	28
DVD Connection .....	11	DTV Caption.....	28
DTV Connection.....	12	DTV Caption Style.....	29
Digital Audio Output .....	12	OSD Timeout.....	29
PC Connection .....	13	Blue screen.....	29
Monitor Out Setup .....	14	OSD transparency.....	29
HDMI .....	14	<b>Adjust Menu</b>	
Cable Sample.....	15	Screen Setup for PC mode.....	30
Connecting Headphones .....	16	<b>Lock Menu</b>	
Power source.....	16	Parental Control rating and categories.....	31
<b>Operation</b>		<b>Others Functions</b>	
Switching On/Off the TV set .....	17	Brief Info. ....	34
Choose the Menu Language .....	17	Quick program view.....	34
Choose the input Source.....	17	Setting up your remote control .....	35
<b>Channel Menu</b>		Remote Control Codes .....	37
Automatic Scan .....	18	<b>Maintenance</b> .....	41
Manual Scan .....	19	<b>Product Specifications</b> .....	42
Fine Tune.....	19	<b>Troubleshooting</b> .....	43
Edit Program.....	20	<b>Warranty</b> .....	44
Rename .....	20		
Select the desired program. ....	21		
Select the desired sound .....	21		
Mute .....	21		
<b>Video Menu</b>			
How to select picture modes.....	22		
How to customize your own picture status .....	22		
Aspect Ratio Control .....	23		
<b>Audio Menu</b>			
How to select audio modes.....	24		
How to customize your own audio status .....	24		
SAP Broadcasts Setup.....	25		

# Controls

- This is a simplified representation of front panel.
- Here shown may be somewhat different from your TV.

## Front panel controls

HL26B HL32B HL37B HL40B HL42B

- 1.INPUT: all input source display and OK confirm.
- 2.CH(▼▲): Program minus and plus, menu options
- 3.VOL(◀▶): Volume increase and decrease, menu reset and entry
- 4.MENU: Menu display
5. ⏻ (POWER) : Is used to activate the display or return to standby mode.

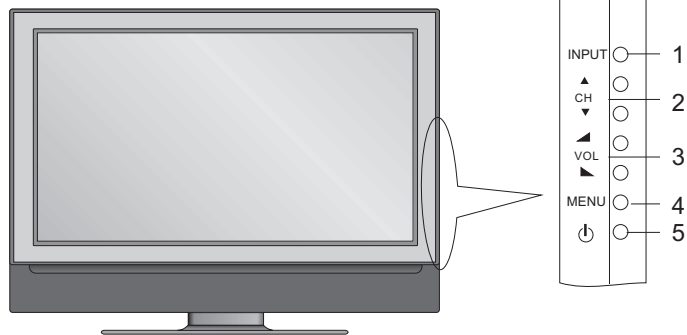

HL26S HL32S HL37S HL42S

**AUDIO2 Input**  
connect to hear stereo sound from an external device.

**VIDEO2 Input**  
Connects the video signal from a videodevice.

**Power Cord Socket**  
This TV operates on AC power.  
The voltage is indicated on the Specifications page.  
Never attempt to operate the TV on DC power.  
(Only for HL42S)

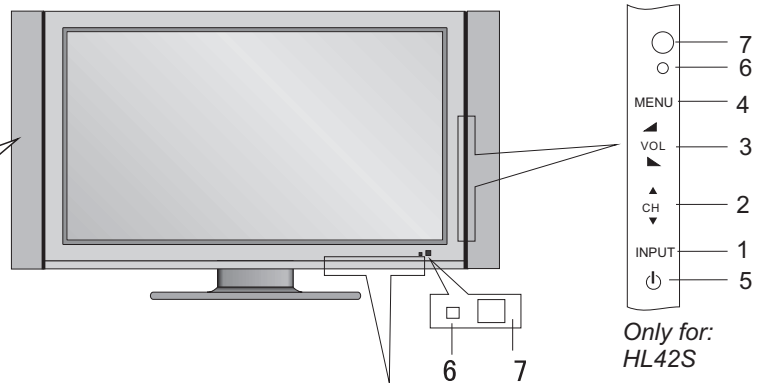
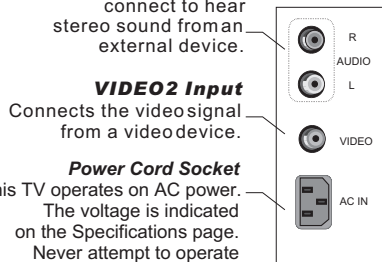

- 1.INPUT: all input source display and OK confirm.
- 2.CH (▼▲) : program minus and plus, menu options.
- 3.VOL (◀▶): volume decrease and increase, menu reset and entry.
- 4.MENU: menu display.
5. ⏻ (POWER) : Is used to activate the display or return to standby mode.
- 6.Power indicator: in red when standby mode, in blue when display.
- 7.Remote control signal receive window.

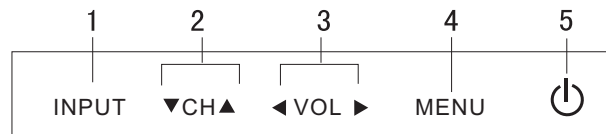

(The buttons are on the bottom of the TV set)

# Connection Options

## Back panel controls

## Back panel controls

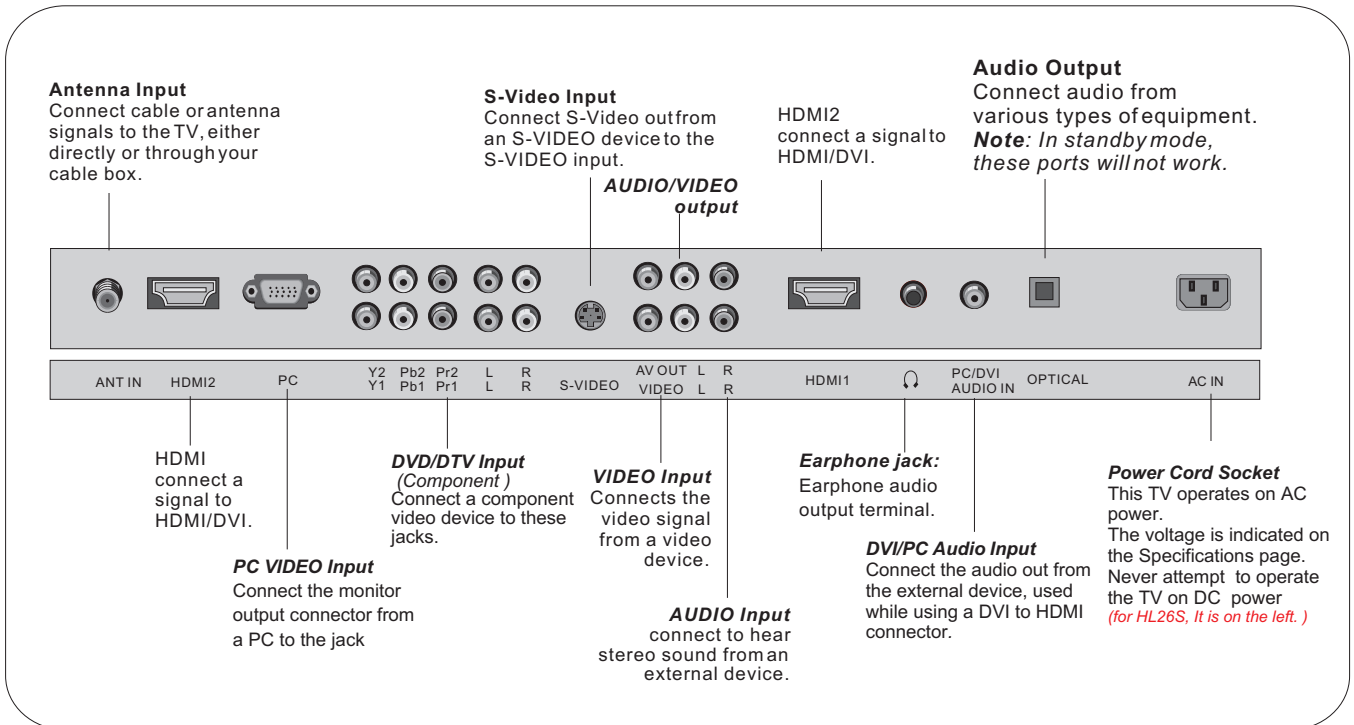

# Universal Remote Controller

- The remote controller cannot be operated unless the batteries are properly loaded.
- When using the remote control, aim it at the remote control sensor on the TV.

## Function introduction

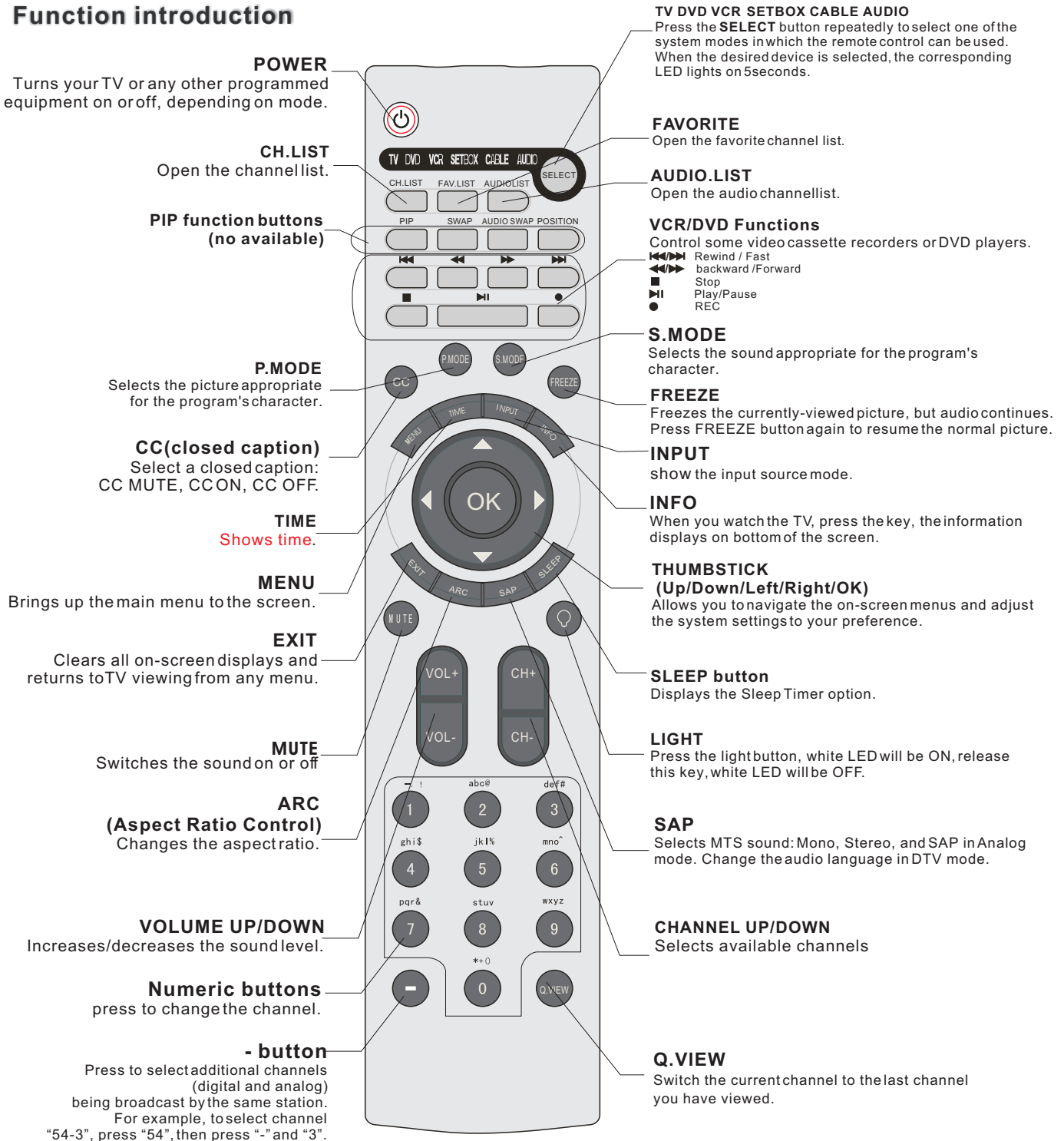



# External Equipment Connections

## Accessories



Remote controller



Owner`s manual

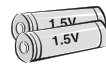

Alkaline battery(AAA)×2



Power cable

## Antenna Connection

Generally speaking, to enjoy a clearer picture, we recommend that you use a CATV system or an outdoor antenna. In different places, the suitable antenna type and position are different.

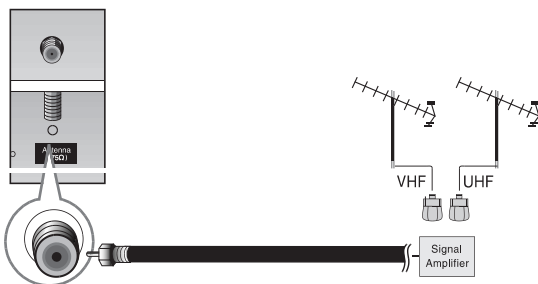
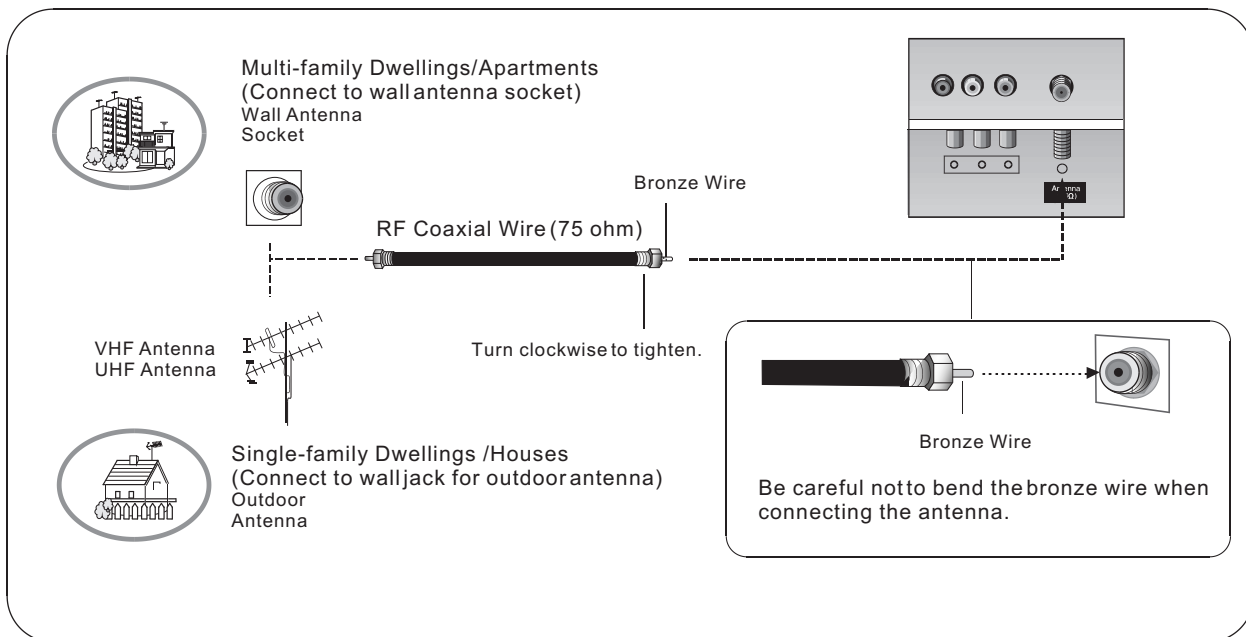

- To improve the picture quality in a poor signal area, please purchase a signal amplifier and install properly.
- If the antenna needs to be split for two TV`s, install a "2-Way Signal Splitter" in the connections.
- If the antenna is not installed properly, contact your dealer for assistance.

# External Equipment Connections

NOTE: All cables shown are not included with the TV.

## Choose Your Connection

There are several ways to connect your television, depending on the components you want to connect and the quality of the signal you want to achieve. The following are examples of some ways to connect your TV. Choose the connection which is best for you.

## VCR connection

- To avoid picture noise (interference), leave an adequate distance between the VCR and TV.

### Connection Option 1

Set VCR output switch to channel 3 or 4 and then tune the TV to the same channel number.

### Connection Option 2

1. Connect the audio and video cables from the VCR's output jacks to the TV input jacks, as shown in the figure.

When connecting the TV to VCR, match the jack colors (Video = yellow, Audio Left = white, and Audio Right = red).

If you connect an S-VIDEO output from VCR to the S-VIDEO input, the picture quality is improved; compared to connecting a regular VCR to the Video input.

2. Insert a video tape into the VCR and press PLAY on the VCR. (Refer to the VCR owner's manual.)

3. Select the input source with using the INPUT button on the remote control, and then press ▲/▼ button to select the source, press the ► button to confirm.

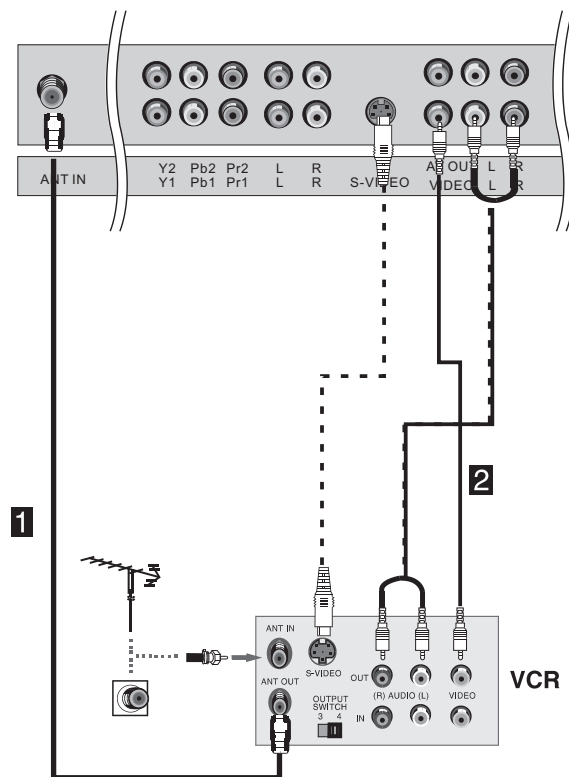

# External Equipment Connections

## External A/V Source Setup

### How to connect

Connect the audio and video cables from the external equipment's output jacks to the TV input jacks, as shown in the figure. When connecting the TV to external equipment, match the jack colors (Video = yellow, Audio Left = white, and Audio Right = red).

### How to use

1. Select the input source with using the INPUT button on the remote control.
2. Press the ▲/▼ button to select the desired source.
3. Press the OK button to confirm
2. Operate the corresponding external equipment.

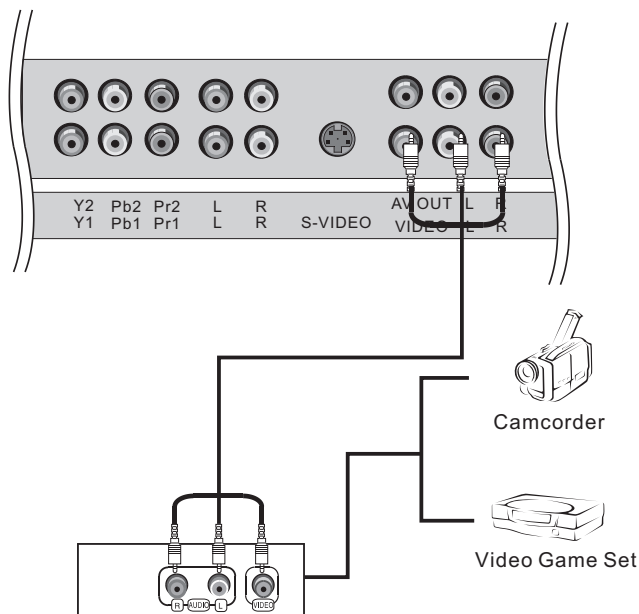

## DVD connection

### How to connect

1. Connect the DVD video outputs (Y, Pb/Cb, Pr/Cr) to the Y, Pb, Pr jacks on the TV and connect the DVD audio outputs to the YPbPr Audio IN jacks on the TV, as shown in the figure.
2. If your DVD only has an S-VIDEO output jack, connect this to the S-VIDEO input on the TV, as shown in the figure.

**NOTE:** If your DVD player does not have component video output, use S-Video.

### How to use

1. Turn on the DVD player, insert a DVD.
2. Use the INPUT button on the remote control to select YPbPr mode.
3. Press Play button on external equipment for program play.
4. Refer to the DVD player's manual for operating instructions.

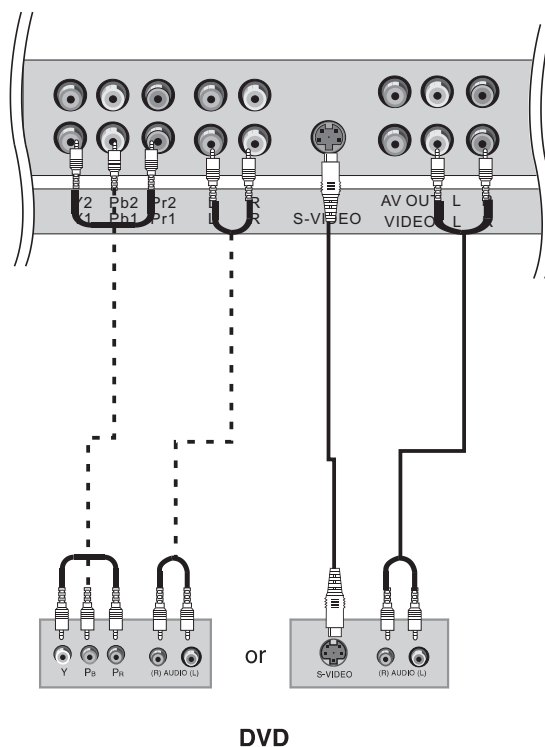

### ■ Component Input ports

To get better picture quality, connect a DVD player to the component input ports as shown below.

Component ports on the TV	Y	Pb	Pr
Video output ports on DVD player	Y	Pb	Pr
	Y	B-Y	R-Y
	Y	Cb	Cr
		P <sub>B</sub>	P <sub>R</sub>

# External Equipment Connections

## DTV connection

- This TV can receive Digital Over-the-air/Cable signals without an external digital set-top box. However, if you do receive Digital signals from a digital set-top box or other digital external device, refer to the figure as shown below.
- This TV supports HDCP (High-bandwidth Digital Contents Protection) protocol for Digital Contents (480p, 720p, 1080i).

### How to connect

Use the TV's (Y, PB, PR), VGA or HDMI jack for video connections, depending on your set-top box connector. Then, make the corresponding audio connections.

### How to use

1. Turn on the digital set-top box. (Refer to the owner's manual for the digital set-top box.)
2. Use INPUT on the remote control to select YPbPr, VGA, or HDMI source.

Signal	YPbPr	HDMI/DVI
480i	Yes	Yes
480p	Yes	Yes
720p	Yes	Yes
1080i	Yes	Yes

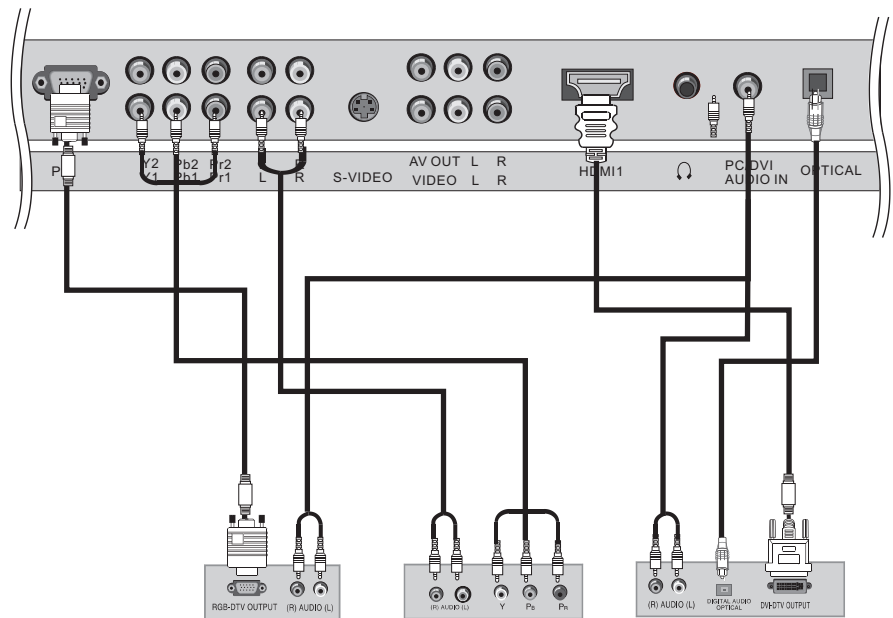

Digital Set-top Box

## Audio Output

Send the TV's audio to external audio equipment (stereo system) via the Audio Output (Optical) port.

### How to connect

1. Connect one end of an optical cable to the TV Audio (Optical) Output port.
  2. Connect the other end of the optical cable to the digital audio (optical) input on the audio equipment.
- See the external audio equipment instruction manual for operation.

**Note:** When connecting with external audio equipments, such as amplifiers or speakers, please turn the TV speakers off.

**Caution:** Do not look into the optical output port. Looking at the laser beam may damage your vision.

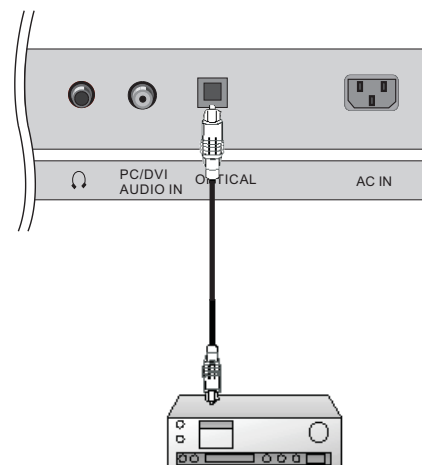

# External Equipment Connections

## PC connection

### How to connect

1. To get the best picture quality, adjust the PC graphics card to 1024x768 .
2. Use the TV's PC or DVI (Digital Visual Interface) Audio IN port for video connections, depending on your PC connector.
  - If the graphic card on the PC does not output analog and digital RGB simultaneously, connect only one of either VGA IN or DVI IN to display the PC on the TV.
  - If the graphic card on the PC does output analog and digital RGB simultaneously, set the TV to either VGA or DVI; (the other mode is set to Plug and Play automatically by the TV.)
3. Then, make the corresponding audio connection. If using a soundcard, adjust the PC sound as required.

### How to use

1. Turn on the PC and the TV.
2. Turn on the display by pressing the POWER button on the TV's remote control.
3. Use INPUT on the remote control to select VGA or HDMI source.
4. Check the image on your TV. There may be noise associated with the resolution, vertical pattern, contrast or brightness in PC mode. If noise is present, change the PC mode to another resolution, change the refresh rate to another rate or adjust the brightness and contrast on the menu until the picture is clear. If the refresh rate of the PC graphic card can not be changed, change the PC graphic card or consult the manufacturer of the PC graphic card.

### NOTES:

- 1 Use a DVI cable.
- 2 Avoid keeping a fixed image on the TV's screen for a long period of time. The fixed image may become permanently imprinted on the screen.
- 3 The synchronization input form for Horizontal and Vertical frequencies is separate.

### Resolution

Mode	Resolution	Frame frequency (Hz)
VGA	640*480	60Hz
SVGA	800*600	60Hz/75Hz
XGA	1024*768	60Hz
		75Hz

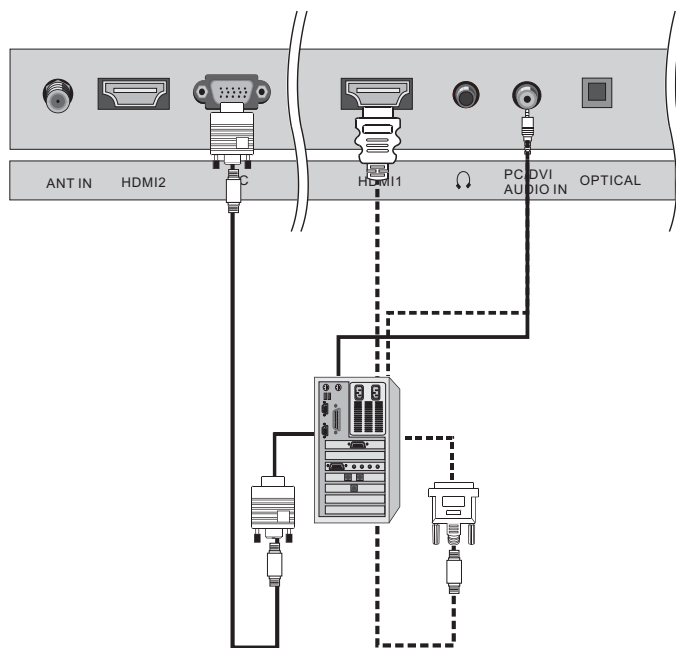

# External Equipment Connections

## Monitor Out Setup

The TV has a special signal output capability which allows you to hook up a second TV or monitor.

Connect the second TV or monitor to the TV's AV OUT. See the Operating Manual of the second TV or monitor for further details regarding that device's input settings.

### Notes:

*YPbPr, VGA, HDMI, DTV input sources cannot be used for Monitor out.*

*When connecting with external audio equipments, such as amplifiers or speakers, please turn the TV speakers off.*

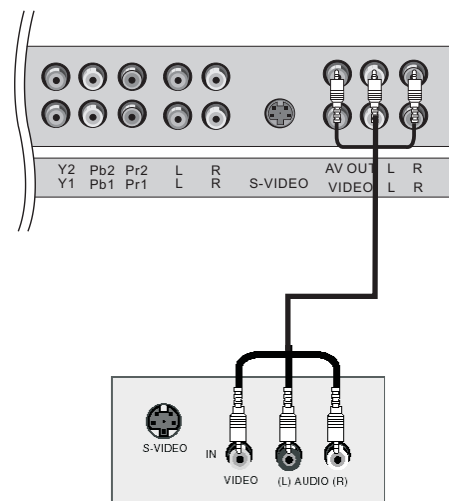

## HDMI

### <When the source device(DVD player or Set Top Box) supports HDMI>

#### How To Connect

1. Connect the source device to HDMI port of this TV with an HDMI cable(not supplied with this product).
2. No separated audio connection is necessary.

#### How To Use

- If the source device supports Auto HDMI function, the output resolution of the source device will be automatically set to 1280x720p.
  - If the source device does not support Auto HDMI, you need to set the output resolution appropriately.
- To get the best picture quality, adjust the output resolution of the source device to 1280x720p.
- Select HDMI input source in input source option of Select Main source menu.

### <When the source device(DVD player or Set Top Box) supports DVI>

#### How To Connect

1. Connect the source device to HDMI port of this TV with a HDMI-to-DVI cable(not supplied with this product).
2. A separated audio connection is necessary.
3. If the source device has an analog audio output connector, connect the source device audio output to DVI Audio In port located on the left side of HDMI port.

#### How To Use

- If the source device supports Auto DVI function, the output resolution of the source device will be automatically set to 1280x720p.
  - If the source device does not support Auto DVI, you need to set the output resolution appropriately.
- To get the best picture quality, adjust the output resolution of the source device to 1280x720p.
- Press the INPUT button to select HDMI input source in input source option of Select Main source menu.

## Cable sample



HDMI Cable  
(not supplied with the product)

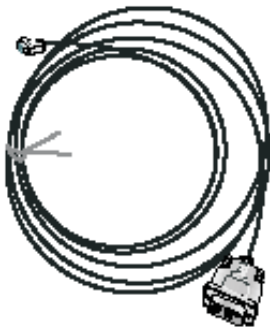

HDMI to DVI Cable  
(not supplied with the product)



Analog Audio Cable  
(Stereo to RCA type)  
(not supplied with the product)

# External Equipment Connections

## Connecting Headphones

You can connect a set of headphones to your set if you wish to watch a TV programme without disturbing the other people in the room.

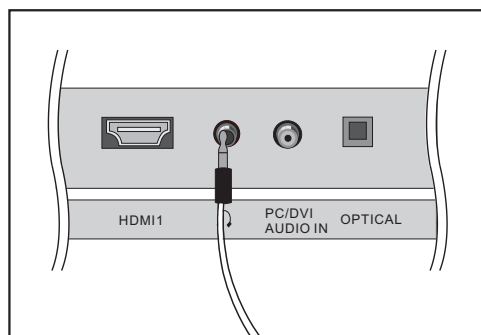

Plug a set of headphones into the 3.5mm mini-jack socket on the rear panel of the set.

### Note:

- Prolonged use of headphones at a high volume may damage your hearing.
- You will not receive sound from the speakers when you connect headphones to the system.

## Power source

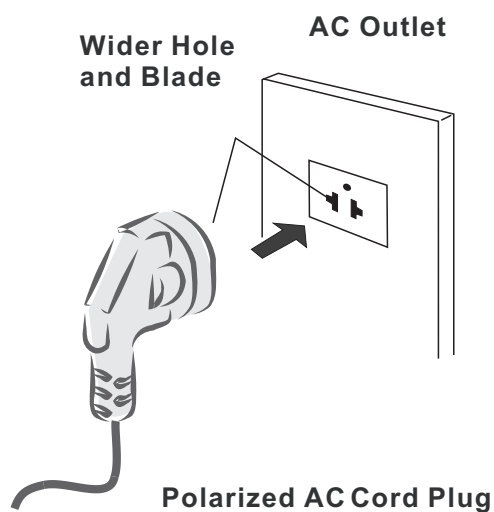

### TO USE AC POWER SOURCE

Use the AC polarized line cord provided for operation on AC. Insert the AC cord plug into a standard polarized AC outlet.

### NOTES:

- Never connect the AC line cord plug to other than the specified voltage. Use the attached power cord only.
- If the polarized AC cord does not fit into a non-polarized AC outlet, do not attempt to file or cut the blade. It is the user's responsibility to have an electrician replace the obsolete outlet.
- If you cause a static discharge when touching the unit and the unit fails to function, simply unplug the unit from the AC outlet and plug it back in. The unit should return to normal operation.



# Operation

- In the manual, the OSD (on screen display) may be different from your TV's, because it is just an example to help you with the TV operation.
- There are several options you might need to set up in order for your TV to work properly. Read the instructions that follow.

## Switching On/Off the TV set

1. First, connect power cord correctly.
2. Select the viewing source by using **INPUT** button on the remote control.
3. When finished using the TV, press the **POWER** button on the remote control. The TV reverts to standby mode.
4. If you intend to be away on vacation, disconnect the power plug from the wall power outlet.

### Note:

If the TV in power on, the screen show information according the type of input signal. the information will disappear. If there is no signal and bluescreen in ON the screen enter in bluescreen and display "No signal" on top and center of the screen.

## Choose the Menu Language

When you start using your set for the first time, you must select the language which will be used for displaying menus and indications.

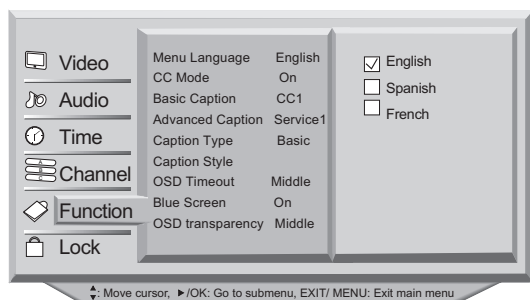

- 1 Press the **MENU** button and then use **▲/▼** button to select the **Function** menu.
- 2 Press the **▶** button and then use **▲/▼** button to select **Menu Language**.
- 3 Press the **▶** button and then use **▲/▼** button to enter the list of available language. (**English, Spanish or French**)
- 4 Select your language with the **▲/▼** button and press the **OK** button to confirm you selection.
- 5 When you are satisfied with your choice, press the **EXIT** button to return to normal viewing or press **MENU** button to return to the previous menu.

## Choose the Input source

- Change the picture source so you can watch your TV, cable TV, VCR, DVD, or any other devices that are connected to your TV.

1. Press the **INPUT** button to enter the Select Main picture Source menu and then use **▲/▼** button to select the desired **items**. (Cable/Air TV, VIDEO1, VIDEO2, SVIDEO, YPBPR1, YPBPR2, VGA, HDMI1, HDMI2.)
2. Press the OK button to confirm.
3. Press INPUT button to return to TV viewing or press EXIT button to return to the previous menu.

### Note:

1. According to your connection device, you can change the name of every source.
2. In channel menu, if the Tuner item is setting as Air or Cable, the source menu will display Air TV or Cable TV;

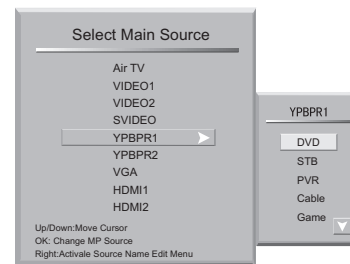

## Channel menu

- This TV set has three methods to set channels, which are respectively Auto Scan, manual Scan, fine tune.
- In this section, how to use the remote control to set channel is explained. You can also use buttons on the TV set to set channel.
- A password is required to gain access to Channel menu if the Lock of Edit program menu is turned on.

### Automatic Scan

- Automatically finds all channels available through antenna or cable inputs, and stores them in memory on the All Channel List.

Note : the Channel menu will be only operated in normal TV mode.

- 1 Press the **MENU** button and then use **▲/▼** button to select the **Channel** menu.
- 2 Press the **▶** button and then use **▲/▼** button to select **Tuner**.
- 3 Press the **▶** button and then use **▲/▼** button to Select **Cable** or **Air** mode.
- 4 Press the **OK** button
- 5 When you are satisfied with your choice, press **MENU** button to return to the previous menu.
- 6 Press the **▲/▼** button to select **Auto Scan**.
- 7 Press the **▶** button and press the **OK** button to start searching.
- 8 To cancel searching, press the **OK** button.

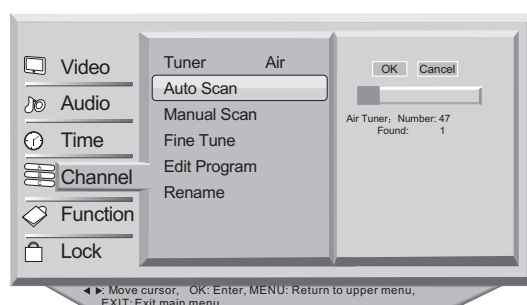
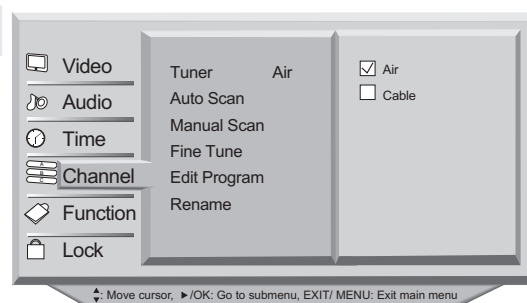

When **Air** is selected, the TV will detect antenna signals and will search for antenna TV (NTSC and ATSC) channels available in your local area.

When **Cable** is selected, the TV will detect cable company supplied signals and will search for cable TV (NTSC, ATSC, QAM modulated) channels available in your area.

# Channel menu

## Manual Scan

If excessive channel signals of unwanted programs are received in local area, manual search function is recommended.

- 1 Press the **MENU** button and then use **▲/▼** button to select the **Channel** menu.
- 2 Press the **▶** button and then use **▲/▼** button to select **Tuner**.
- 3 Press the **▶** button and then use **▲/▼** button to Select **Cable** or **Air** mode.
- 4 Press the **OK** button.
- 5 When you are satisfied with your choice, press **MENU** button to return to the previous menu.
- 6 Press the **▲/▼** button to select **Manual Scan**.
- 7 Press the **▶** button and then use digital buttons to select channel number you want to add or delete.
- 8 Press the **▼** button to select OK item and press **OK** button to add for the channel number.
- 9 Press **EXIT** button to return to TV viewing or press **MENU** button to return to the previous menu.

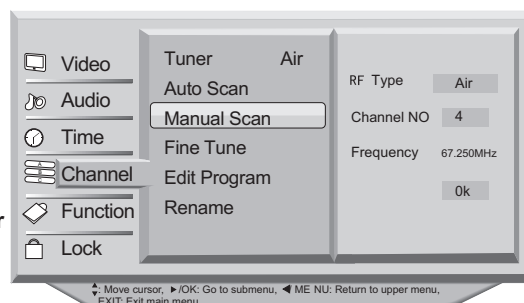

## Fine Tune (only in analog signal )

- 1 Press the **MENU** button and then use **▲/▼** button to select the **Channel** menu.
- 2 Press the **▲/▼** button to select **Fine Tune**.
- 3 Press the **▶** or **OK** button
- 4 Press the **◀/▶** button to tune.
- 5 Press **EXIT** button to return to TV viewing or press **MENU** button to return to the previous menu.

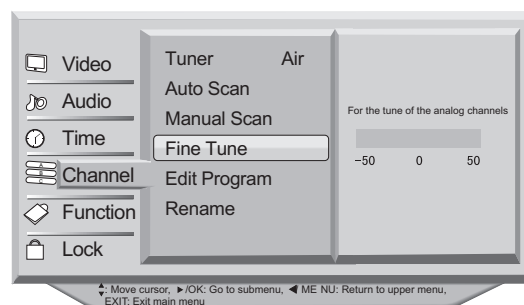

## Channel menu

### Edit Program

- You can create your own Favorite List. Use the “FAV.LiST” button on the remote control when a channel is highlighted and then you can add or delete the channel to/from the Favorite List.
- You can skip some channel;
- You can lock some channel;

1 Press the **MENU** button and then use **▲/▼** button to select the **Channel** menu.

2 Press the **▶** button and then use **▲/▼** button to select **Edit Program**.

3 Press the **▶** button. You will now see a screen filled with channel numbers.

4 Use **▲/▼/◀/▶** button to select FAV., Lock or Skip item, and then use the **OK** button to confirm.

5 When you are satisfied with your choice, press **MENU** button to return to the previous menu or Press **EXIT** button to return to TV viewing.

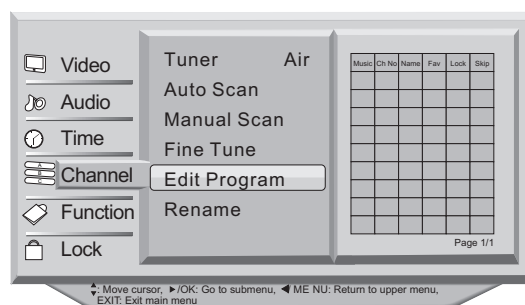

### Skip

After the programs are presetting, you can skip some programs so that to select your favorite channels only.

### Lock

After the programs are presetting, you can lock some programs so that to select your favorite channels only.

### Fav (Favorite)

Press the “FAV.LiST” button open the favorite channel list, press **▲/▼** button to select the channel and press **OK** button to confirm.

### Rename (only in analog signal)

1 Press the **MENU** button and then use **▲/▼** button to select the **Channel** menu.

2 Press the **▶** button and then use **▲/▼** button to select **Rename**.

3 Press the **▶** or **OK** button to enter the Submenu.

4 The cursor flashes, Use the digital button to select the letter, and press **◀/▶** button to move the cursor and **OK** button to confirm. (Press the **Q.VIEW** button to delete the letter.)

5 When you are satisfied with your choice, press **MENU** button to return to the previous menu or Press **EXIT** button to return to TV viewing.

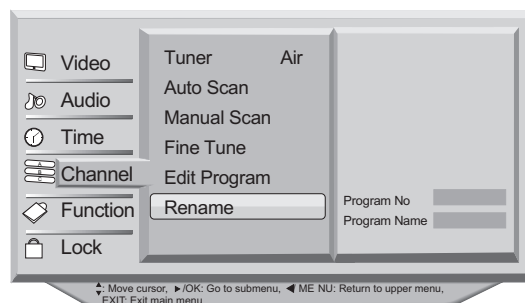

## Select the desired program

1 Using the CH+/- buttons.

- Press the CH+ button to select a channel number in number increasing direction.
- Press the CH- button to select a channel number in number decreasing direction.

(Note: If Skip is ON on one channel, press CH+/- button, the channel will not appear.)

## Select the desired sound

Press the VOL-/+ or ◀/▶ buttons on the remote or the front of the TV set to adjust the volume level. The range is 0~100. When the volume buttons are pressed the volume level is displayed automatically on the TV screen.

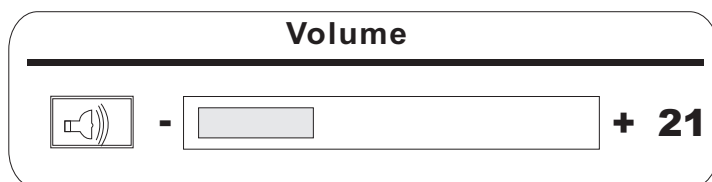

## Mute

*When you need to pay attention to surrounded sounds, or there is a telephone calling you or there are some guests visiting you, the sound elimination (mute) function is very convenient.*

1 Press the MUTE button on the remote control and "MUTE" type face will display on the screen. At this time, the sound of the TV set is turned off.

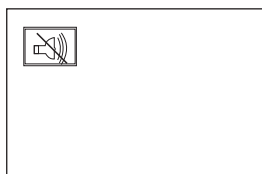

2 If you want to recover the sound, press the MUTE button again or directly press VOL+ buttons.

## Video menu

The TV menu gives you an overview of the menus you can select.

Note: Depending on the input signal, one or more menu items may not be selectable.

### How to select picture modes

The picture mode provides the pre-defined images settings. There are four settings: standard/vivid /mild/custom.

Press P.MODE button on the remote controller the Video Mode list is out , press P.MODE to select the option (Standard/Vivid/Mild/Custom)

- **Standard:** normal mode.
- **Vivid:** mode of watching the movement of picture.
- **Mild:** the effect of the picture is soft.
- **Custom:** picture effect which you favorite.

### How to customize your own picture status

- 1 Press the **MENU** button and then use **▲/▼** button to select the **Video** menu.
- 2 Press the **▶** button and then use **▲/▼** button to select the desired items.
- 3 Press the **▶** button and then use **▲/▼** button to adjust the setting.
- 4 When you are satisfied with your choice, press **MENU** button to return to the previous menu or press the **EXIT** button to return to TV viewing.

#### ■ Contrast

This will adjust the intensity of bright parts in the picture but keep the dark parts unchanged.

#### ■ Brightness

This will adjust the light output of the complete picture, which will mainly affect the darker areas of the picture.

#### ■ Tint

Allows you to select the color mix (Tint) of the picture.

#### ■ Color

This will adjust the saturation level of the colors to suit your personal preference.

#### ■ Sharpness

This will adjust the sharpness of fine details in the picture.

#### ■ DNR (Digital Noise Reduction)

Automatically filters out and reduces the image noise and improves picture quality when receiving weak video signals.

Select **Off/Weak/Medium/Strong** according to the image noise.

#### ■ Color temperature

This will increase or decrease **Warm** (red) and **Cold** (blue) colors to suit personal preferences.

Select **Cold** to give the white colors a blue tint, **Standard** to give the white colors a neutral tint, **Warm** to give the white colors a red tint.

#### ■ Black Stretch

This will increase automatically the contrast range.

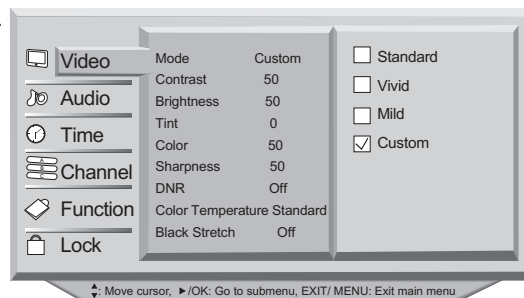

#### **Note:**

Only when the item of mode is custom , the Contrast, Brightness, Tint, color, Sharpness can be set by user . In other mode the value of them are preset by program .

# Aspect Ratio Control

- Lets you choose the way an analog picture with a 4:3 aspect ratio is displayed on your TV with a 16:9 ratio picture format.

- **Note:** If a fixed image is displayed on the screen for a long time, it image may become imprinted on the screen and remain visible.

**1** Press the **ARC** button the Aspect Ratio menu appearance on the screen.

**2** Press the **▲/▼** button to select the desired picture format.

**3** Press the **OK** button to confirm.

## ■ 4:3 mode

Choose **4:3** when you want to view a picture with an original 4:3 aspect ratio, with gray bars appearing at both the left and right sides.

## ■ 16:9 mode

Choose **16:9** when you want to adjust the picture horizontally, in a linear proportion to fill the entire screen.

## ■ Zoom 1

Choose **Zoom 1** when you want to view the picture without any alteration. However, the top and bottom portions of the picture will be cropped.

## ■ Zoom 2

Choose **Zoom 2** when you want the picture to be altered, both vertically extended and cropped. The picture taking a halfway trade off between alteration and screen coverage.

## ■ Subtitle

Choose **Subtitle** when you want to adjust the picture in a non-linear proportion, that is, more enlarged at top sides and no alteration, at bottom side.

## ■ PANORAMA

Choose **PANORAMA** when you want to enlarge the picture in correct proportion.

**Note:** When enlarging or reducing the picture size, the image may become distorted.

## Notes

■ In TV, VIDEO1, VIDEO2, SVIDEO modes, all screen modes can be selected.

(16:9 Mode . Panorama . Zoom1 . Zoom2 . 4:3 Mode. Subtitle).

■ In YPbPr, HDMI modes, only 16:9 Mode, 4:3 modes, Zoom1 or Zoom2 can be selected.

■ In VGA mode, only 16:9 Mode, 4:3 mode, dot by dot can be selected.

■ In DTV mode, only 16:9 Mode, 4:3 mode can be selected.

# Audio menu

## How to Select Audio modes

Press S.MODE button on the remote controller the Audio Mode list is out, press S.MODE to select the option (Live/POP/Rock/Custom).

- **Custom** A spare setting that can be adjusted to personal tastes.
- **Live** Normal sound with moderate bass and treble setting.
- **POP** Designed to reduce the bass and treble which enhances the voice for news programs.
- **Rock** Enables extra bass and treble to enhance the movie experience.

## How to Customize your own audio status

- 1 Press the **MENU** button and then use **▲/▼** button to select the **Audio** menu.
- 2 Press the **▶** button and then use **▲/▼** button to select the desired items.
- 3 Press the **▶** button and then use **▲/▼** button to adjust the setting.
- 4 When you are satisfied with your choice, press **MENU** button to return to the previous menu or press the **EXIT** button to return to TV viewing.

### ■ Headphone volume

This controls the level of sound through the headphones.

### ■ Volume

This will adjust the sound output level.

### ■ Balance

This will adjust the output of the right and left speakers to obtain the best stereo reproduction for your listening position.

### ■ Equalizer Mode

This sound setting can be adjusted to suit your personal preference.

### ■ Digital Audio (only selectable with digital broadcast signals)

Make your selection of the source to which the device with digital audio input has been connected.

In addition to accepting audio input via Digital Audio In, the TV can output Digital audio via the **Optical** connector to an external amplifier or receiver. If your amplifier or receiver has a matching connector for Digital Audio In, you can connect it with a single cable to the TV's **Optical**.

### ■ AVL (Automatic volume control)

This will reduce the differences in volume level among broadcasters.

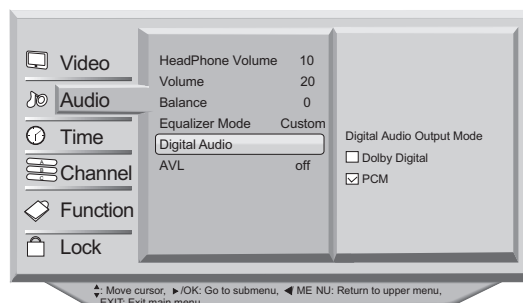
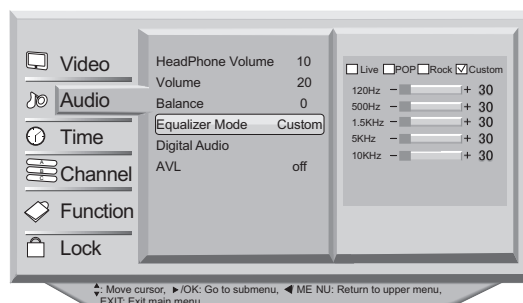
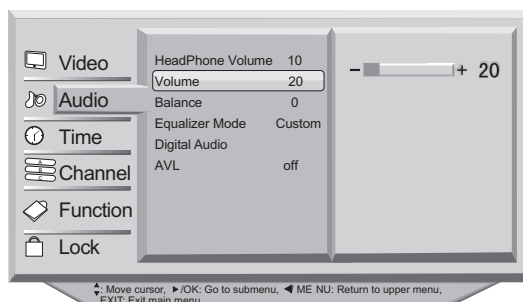



## Audio menu

### SAP Broadcasts Setup

- This TV can receive MTS stereo programs and SAP (Secondary Audio Program) that accompanies the stereo program; if the station transmits an additional sound signal as well as the original one.
- When having selected SAP button on the remote control, this TV can only receive the signal when the TV station transmits the proper signals.
- Mono sound is automatically received if the broadcast is only in Mono; even though Stereo or SAP has been selected.
- Select Mono if you want to listen to mono sound during stereo/SAP broadcasting.
- Stereo or SAP can be received in a Analog channel.

1. Use the **SAP** button to select your desired MTS mode in a analog signal. Each time you press the **SAP** button, **Mono**, **Stereo**, or **SAP** appear.

If other languages are available on the digital signal, select them with the **SAP** button.

2. Press **EXIT** button to save and return to TV viewing.

# Time menu

## Date /Time setting

Setting the clock is necessary in order to use the various timer features of the TV. Also, you can check the time while watching the TV.

- 1 Press the **MENU** button and then use **▲/▼** button to select the **Time** menu.
- 2 Press the **▶** button and then use **▲/▼** button to select the **Date/Time**.
- 3 Press the **▶** button and then use **◀/▶** button to select the Mode: **Manual** or **Auto**.
- 4 When you are satisfied with your choice, press **MENU** button to return to the previous menu or press the **EXIT** button to return to TV viewing.

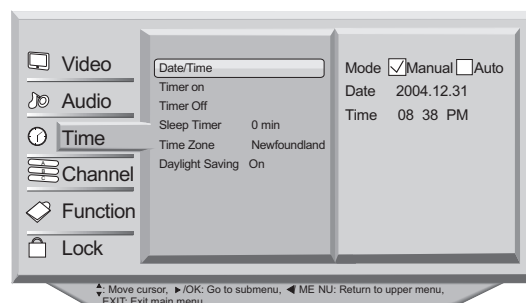

## Timer on setting

*Switch on automatically at the time you presetting.*

- 1 Press the **MENU** button and then use **▲/▼** button to select the **Time** menu.
- 2 Press the **▶** button and then use **▲/▼** button to select the **Timer On**.
- 3 Press the **▶** button and then use **◀/▶** button to select the Mode: **Off**, **Once** or **Daily**.
- 4 Press the **OK** button to confirm.  
When selecting **Once** or **Daily** item, **On time** item will be active, press **▲/▼** button to set the desired level, press **◀/▶** button to button move cursor.
- 5 When you are satisfied with your choice, press **MENU** button to return to the previous menu or press the **EXIT** button to return to TV viewing.

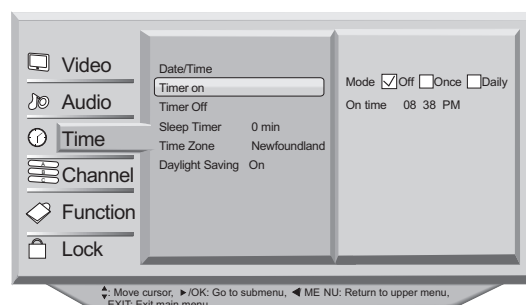

## Timer off setting

*Switch off automatically at the time you presetting.*

- 1 Press the **MENU** button and then use **▲/▼** button to select the **Time** menu.
- 2 Press the **▶** button and then use **▲/▼** button to select the **Timer Off**.
- 3 Press the **▶** button and then use **◀/▶** button to select the Mode: **Off**, **Once** or **Daily**.
- 4 Press the **OK** button to confirm.  
When selecting **Once** or **Daily** item, **Off time** item will be active, press **▲/▼** button to set the desired level, press **◀/▶** button to button move cursor.
- 5 When you are satisfied with your choice, press **MENU** button to return to the previous menu or press the **EXIT** button to return to TV viewing.

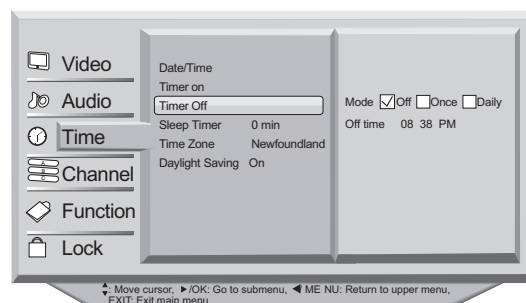

# Time menu

## Sleep Timer setting

*The sleep timer automatically shuts off the TV after a preset time (from 15 to 120 minutes).*

- 1 Press the **MENU** button and then use **▲/▼** button to select the **Time** menu.
- 2 Press the **▶** button and then use **▲/▼** button to select the **Sleep Timer**.
- 3 Press the **▶** button and then use **▲/▼** button to select the number of minutes. Select **0Min, 15Min, 30Min, 60Min, 90Min, 120Min**.

When the number of minutes you want is displayed on the screen, press the **OK** button. The time begins to count down from the number of minutes selected.

- 4 When you are satisfied with your choice, press **MENU** button to return to the previous menu or press the **EXIT** button to return to TV viewing.

- 5 To cancel the set sleep timer:

Press the **▲/▼** button to select **0min**.

You can use the **SLEEP** button also to select quickly the sleep timer.

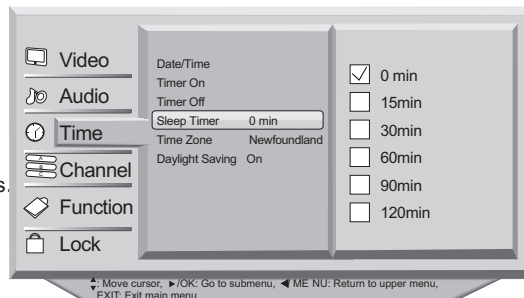

## Time zone setting

*(only available when date/time mode is set to Automatic)  
This function allows you to select your local time zone.  
Broadcasted time information will correct the clock display for your local time.*

- 1 Press the **MENU** button and then use **▲/▼** button to select the **Time** menu.
- 2 Press the **▶** button and then use **▲/▼** button to select the **Time Zone** items.
- 3 Press the **▶** button and then use **▲/▼** button to adjust the setting.
- 4 When you are satisfied with your choice, press **MENU** button to return to the previous menu or press the **EXIT** button to return to TV viewing.

Press the **▶** button and then use **▲/▼** button to select your viewing area time zone: **Newfoundland, Atlantic, Eastern, Central, Mountain, Pacific, Alaska, Hawaii** or **Samoa**.

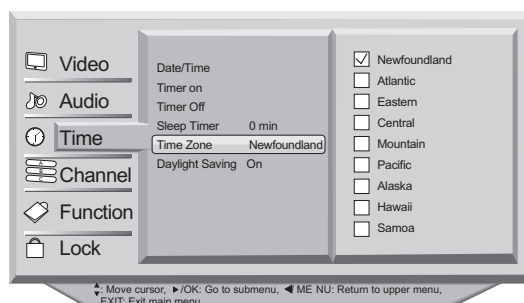

## Daylight Saving setting

*(only available when date/time mode is set to Automatic)  
Daylight saving time is automatically set by specially broadcasted signals.  
This menu item allows you to disable the automatic setting of daylight saving time. This is useful if you live in an area or state where daylight saving is not applied, but you receive channels from other areas where daylight saving signals are broadcasted.*

- 1, Press **▲/▼** button to select **Daylight Saving** item.
2. Press the **▶** button to select **On** for automatic clock correction for daylight saving time, based on specially broadcasted signals. Select **Off** to disable automatic clock correction based on the specially broadcasted signals.

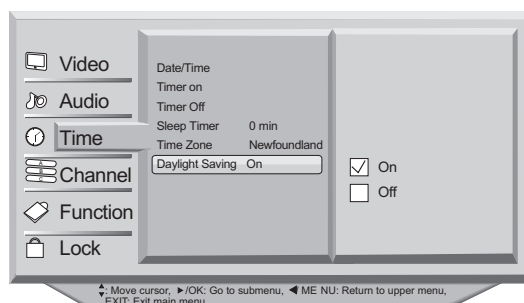

# Function menu

## Closed Captions

Closed captioning is a process which converts the audio portion of a television program into written words which then appear as subtitles on the television screen. Closed captions allow viewers to read the dialogue and narration of television programs.

### Using Closed Captions

Captions are the subtitles of the dialogue and narration of television programs. For prerecorded programs, program dialogue can be arranged into captions in advance. It's possible to caption a live program by using a process called real-time captioning, which creates captions instantly. Real-time captioning is normally done by professional reporters using a machine shorthand system and computer for translation into English. Captioning is an effective system for the hearing-impaired, and it can also aid in teaching language skills.

### CC mode

1. Press the **MENU** button and then use **▲/▼** button to select the **Function** menu.
2. Press the **▲/▼** button to select the **CC mode**.
3. Press the **▶** button and then use **▲/▼** button to select the items: (**On**, **Off** or **On When mute**.)
4. When you are satisfied with your choice, press **MENU** button to return to the previous menu or press the **EXIT** button to return to TV viewing.

### Basic Caption

This allows you to configure the way you choose to view the digital captioning.

1. Press the **MENU** button and then use **▲/▼** button to select the **Function** menu.
2. Press the **▶** button and then use **▲/▼** button to select Basic Caption.
3. Press the **▶** button and then use **▲/▼** button to select caption: **CC1**, **CC2**, **CC3**, **CC4**, **Text1**, **Text2**, **Text3**, or **Text4**.
4. When you are satisfied with your choice, press **MENU** button to return to the previous menu or press the **EXIT** button to return to TV viewing.

#### ■ CAPTION

The term for the words that scroll across the bottom of the TV screen; usually the audio portion of the program provided for the hearing impaired.

#### ■ TEXT

The term for the words that appear in a large black frame and almost cover the entire screen; usually messages provided by the broadcaster.

### Advanced Caption(In DTV mode)

This allows you to configure the way you choose to view the digital captioning.

Select one of the digital service channels made available by the caption provider.

There are 6 standard services. Service 1 is designated as the Primary Caption Service. This service contains the verbatim, or near-verbatim captions for the primary language being spoken in the accompanying program audio.

Service 2 is designated as the Secondary Language Service. This service contains captions in a secondary language which are translations of the captions in the primary Caption Service. The other service subchannels are not pre-assigned. It is up to the discretion of the individual caption provider to utilize the remaining service channels.

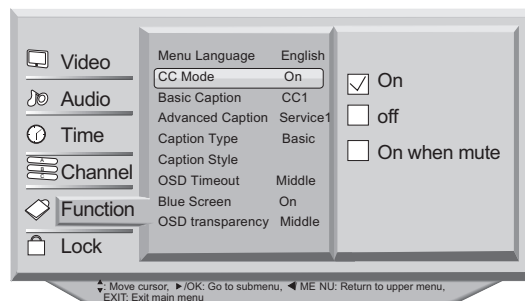

**Note:** The captions do not always use correct spelling and grammar. Not all TV programs and product commercials are made for broadcast with Closed Caption information included. Refer to your area's TV program listings for the TV channels and times of Closed Caption shows. The captioned programs are usually noted in the TV listings with service marks such as "CC".

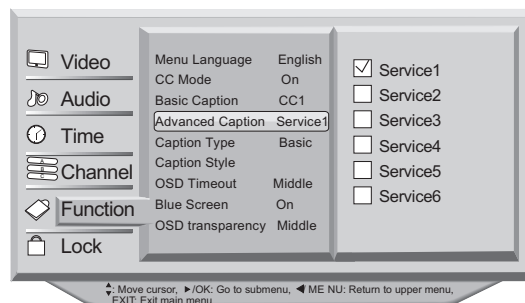
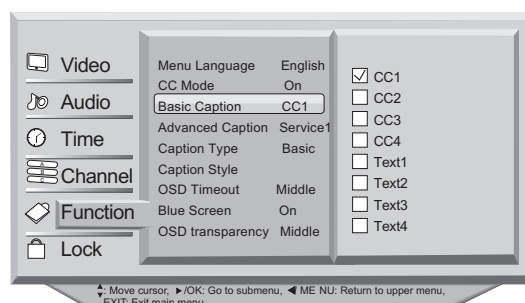

## Caption Style (In DTV mode)

This allows you to modify how digital captions are displayed on your TV. Select from the following options to change the visual characteristics of your TV's digital captioning.

1. Press the **MENU** button and then use **▲/▼** button to select the **Function** menu.
2. Press the **▶** button and then use **▲/▼** button to select **Caption Style**.
3. Press the **▶** button and then use **◀/▶** button to set style as **Custom**.
4. Use **▲/▼** button to customize the Style, Font, etc., to your preference.
5. When you are satisfied with your choice, press **MENU** button to return to the previous menu or press the **EXIT** button to return to TV viewing.

### ■ Style

Select this option to select the font style of caption display according to your own preference.

Press the **▲/▼** button to select **Default, Custom, Style1, Style2, Style3, Style4, Style5, Style6, Style7, Style8**.

Press the **OK** button to confirm.

### ■ Size

Select this option to select the size of caption display according to your own preference.

Press the **▲/▼** button to select **Default, Small, Normal** or **Large**,

Press the **OK** button to confirm.

### ■ Font

Select this option to select the font of caption display according to your own preference.

Press the **▲/▼** button to select **Default, Font1, Font2, Font3, Font4, Font5, Font6, Font7, Font8**.

Press the **OK** button to confirm.

### ■ Text color

Select this option to select the text color or the opacity of the text box of caption display according to your own preference.

Select a color and one of the opacity options.

■ **Text Opacity**: Specify the opacity for the text color.

■ **BG (Background) Color**: Select a background color.

■ **BG (Background) Opacity**: Select the opacity for the background color.

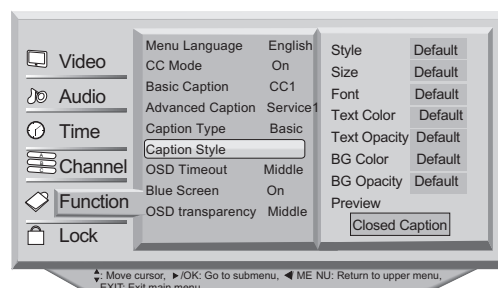

## OSD Timeout

1. Press the **MENU** button and then use **▲/▼** button to select the **Function** menu.
2. Press the **▶** button and then use **▲/▼** button to select **OSD Timeout**.
3. Press the **▶** button and then use **▲/▼** button to select **short, middle** or **Long**.
4. Press the **OK** button to confirm.

## Blue screen

Select this option to select the character background color.

1. Press the **MENU** button and then use **▲/▼** button to select the **Function** menu.
2. Press the **▶** button and then use **▲/▼** button to select **Blue screen**.
3. Press the **▶** button and then use **▲/▼** button to select **on** or **off**.
4. Press the **OK** button to confirm.

## OSD transparency

1. Press the **MENU** button and then use **▲/▼** button to select the **Function** menu.
2. Press the **▶** button and then use **▲/▼** button to select **OSD transparency**.
3. Press the **▶** button and then use **▲/▼** button to select **Low**, **middle** or **High**.
4. Press the **OK** button to confirm.

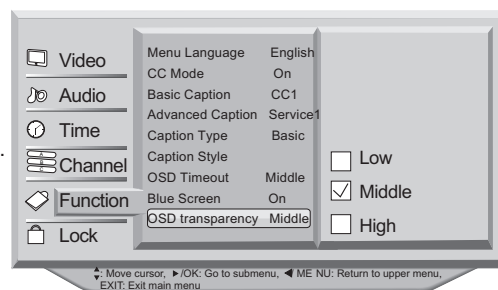
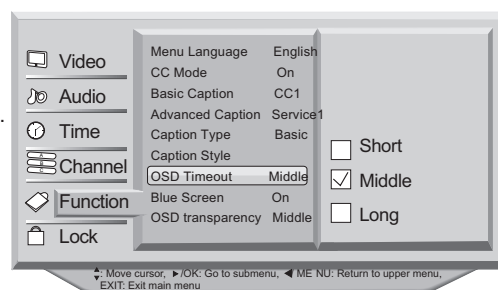

# Adjust menu

## Screen Setup for PC mode

- When RGB connect to PC input and select the VGA, this function is used.

## Adjustment for screen Position, Size, Phase, Reset

- Display PC Adjust Menu by pressing **INPUT** button then use ▲/▼ button to select the VGA item.

- Position : Adjust the screen position.
- Size : Adjust the screen size.
- Phase : Adjust the phase of Pixel clock.
- Mode : there are two modes: Auto Sync and default

- 1 Press the **MENU** button and then use ▲/▼ button to select the **Adjust** menu.
- 2 Press the ► button and then use ▲/▼ button to select the desired items.
- 3 Press the ► button and then use ◀/▶ button to adjust the setting.
- 4 When you are satisfied with your choice, press **MENU** button to return to the previous menu or press the **EXIT** button to return to TV viewing.

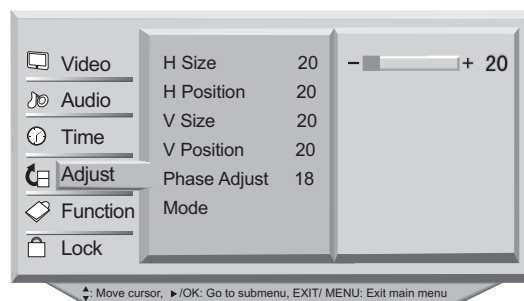

# Lock Menu

Parental Control can be used to block specific channels, ratings and other viewing sources.

The Parental Control Function is used to block program viewing based on the ratings sent by the broadcasting station.

The default setting is to allow all programs to be viewed. Viewing can be blocked by choosing the type of the program and the categories.

It is also possible to block all program viewing for a time period. To use this function, the following must be done :

1. Set ratings and categories to be blocked.
2. Specify a password
3. Enable the lock

## Parental Control rating and categories

Rating guidelines are provided by broadcasting stations. Most television programs and television movies can be blocked by TV Rating and/or Individual Categories. Movies that have been shown at the theaters or direct-to-video movies use the Movie Rating System (MPAA) only.

### Ratings for Movies previously shown in theaters:

#### Movie Ratings :

- |         |                                |
|---------|--------------------------------|
| ■ NR    | (Permits all programs)         |
| ■ G     | (General audience)             |
| ■ PG    | (Parental guidance suggested)  |
| ■ PG-13 | (Parents strongly cautioned)   |
| ■ R     | (Restricted)                   |
| ■ NC-17 | (No one 17 and under admitted) |
| ■ X     | (Adult only)                   |

If you set PG-13 : G and PG movies will be available , PG-13, R, NC-17 and X will be blocked.

### Ratings for Television programs including made-for-TV movies :

- |         |                               |
|---------|-------------------------------|
| ■ TV-Y  | (All children)                |
| ■ TV-Y7 | (Children 7 years older)      |
| ■ TV-G  | (General audience)            |
| ■ TV-PG | (Parental guidance suggested) |
| ■ TV-14 | (Parents strongly cautioned)  |
| ■ TV-MA | (Mature audience only)        |

#### TV Rating Children:

- |                         |                          |
|-------------------------|--------------------------|
| ■ ALL (Age)             | (applies to TV-Y, TV-Y7) |
| ■ FV (Fantasy Violence) | (applies to TV-Y7)       |

#### TV Rating General:

- |                                  |  |
|----------------------------------|--|
| ■ ALL (Age)                      | (applies to TV-G, TV-PG, TV-14, TV-MA) |
| ■ D (Dialogue - sexual dialogue) | (applies to TV-PG, TV-14)              |
| ■ L (Language - adult language)  | (applies to TV-PG, TV-14, TV-MA)       |
| ■ S (Sex - sexual situations)    | (applies to TV-PG, TV-14, TV-MA)       |
| ■ V (Violence)                   | (applies to TV-PG, TV-14, TV-MA)       |

## Lock setup

- Set up blocking schemes to block specific channels, ratings, and external viewing sources.
- A password is required to gain access to this menu.

1. Press the **MENU** button and then use **▲/▼** button to select the **LOCK** menu. Then, press the **▶** button.

■ The TV is set up with the initial password “0-0-0-0” and security default password is 9-4-4-3.

2. Use the **▲/▼** button to choose from the right Lock Menu options. Once the option is selected, change the settings to your preference.

■ **Password:** Change the password by inputting a new password twice.

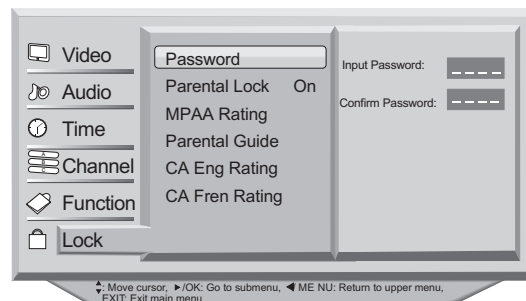

### ■ Parental Lock:

1. Press **▲/▼** button to select **Parental Lock** item.
2. Press the **▶** button to select **On** or **Off**.
3. Press the **OK** button to confirm.

### **Note:**

if the Parental Lock is setting as Off, the change of the MPAA Rating, Parental Guide, CA Eng Rating and CA Fren Rating will be no useful.

■ **Movie Rating (MPAA):** Blocks movies according to the movie ratings limits specified, so children cannot view certain movies. You can set the ratings limit by blocking out all the movies with the ratings above a specified level. Keep in mind that the movie ratings limit only applies to movies shown on TV, not TV programs, such as soap operas.

- 1 Press **▲/▼** button to select **MPAA Rating** item.
- 2 Press the **▶** button and then use **▲/▼** button to select the rating.
- 3 Press the **OK** button to set block or unblock.
- 4 When you are satisfied with your choice, press **MENU** button to return to the previous menu or press the **EXIT** button to return to TV viewing.

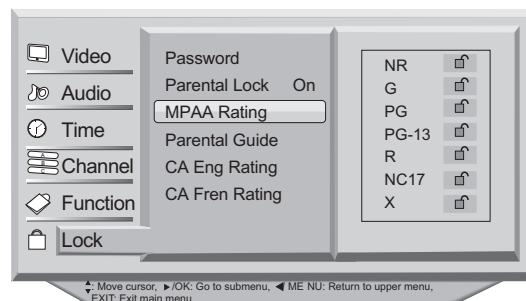



# Lock setup

## Parental Guide

■ **Parental Guide:** Blocks any channels that you do not want to watch or that you do not want your children to watch.

**Note :** The Parental control will automatically block certain categories that are “more restrictive” . For example, if you block “TV-Y” category, then TV-Y7 will automatically be blocked. Similarly, if you block the TV-G category, then all the categories in the “young adult” group will be blocked (TV-Y, TV-Y7, TV-G, TV-PG, TV-14, and TV-MA). The sub-ratings (D, L, S, V) work together similarly.

### How to set the FV, D, L, S and V sub-ratings.

First, the ▲/▼ button select one of these Ratings:

TV-Y, TV-Y7, TV-G, TV-PG, TV-14, or TV-MA, and press the ◀/▶ button.

A symbol “🔒” will be displayed for each sub-rating.

While “🔒” is selected, press the OK button to go to a subrating.

To select a different Rating, press the ▲/▼ buttons and then repeat the process.

Note: The V-chip will automatically block certain categories

that are “More restrictive” .For example, if you block “🔒” sub-rating in TV-PG, then the “🔒” sub-ratings in TV-14 and TV-MA will automatically be blocked.

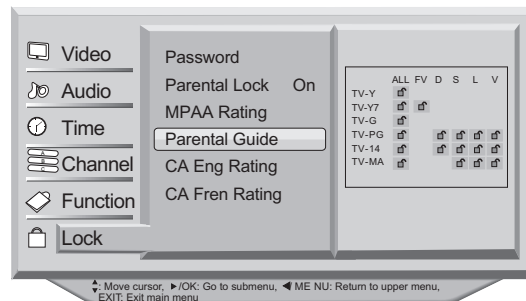

## CA Eng Rating

### Canadian English Language Rating

- 1 Press ▲/▼ button to select CA Eng Rating item.
- 2 Press the ▶ button and then use ▲/▼ button to select the rating.
- 3 Press the ok button to confirm.
- 4 When you are satisfied with your choice, press MENU button to return to the previous menu or press the EXIT button to return to TV viewing.

■ C	Children
■ C8+	Children eight years and older
■ G	General Programming, suitable for all audiences
■ PG	Parental Guidance
■ 14+	Viewers 14 years and older
■ 18+	Adult Programming

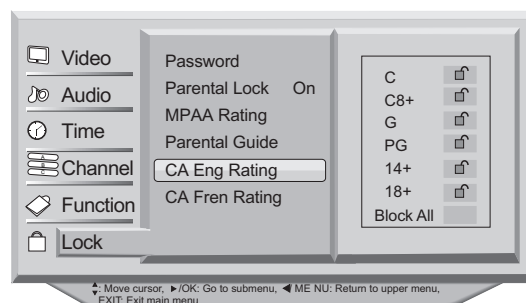

## CA Fren Rating

### Canadian French Language Rating

- 1 Press ▲/▼ button to select CA Fren Rating item.
- 2 Press the ▶ button and then use ▲/▼ button to select the rating.
- 3 Press the ok button to confirm.
- 4 When you are satisfied with your choice, press MENU button to return to the previous menu or press the EXIT button to return to TV viewing.

■ G	General
■ 8 ans+	8+ General - Not recommended for young children
■ 13 ans+	Programming may not be suitable for children under the age of 13
■ 16 ans+	Programming is not suitable for children under the age of 16
■ 18 ans+	Programming restricted to adults

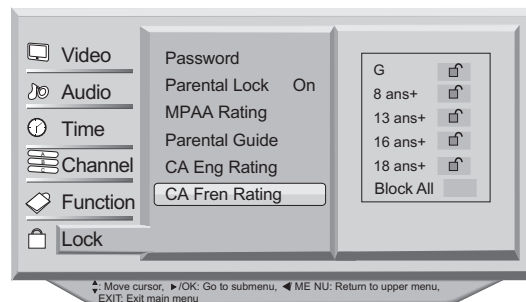

## Brief Info.

- Brief Info shows the presentscreen information.
- Press the **INFO** button to show the Brief Info on the screen.
- Press the **INFO** button or **EXIT** button to exit.

### Function:

- Show the presentscreen information.
- Press the **INFO** button or **EXIT** button to exit.

A: Program title

B: Program rating categories

C: Video resolution

D: Program name

E: Additional information.

F: Program signal intensity

G: Present time, Day of week, Month



## Quick program view

This function enables quick swap to the last watched program.

**1** Suppose the channel number you used just now is 8 and the channel number you are using is 18 (as shown in the figure).

**2** If you want to return to the last watched program channel 8, you can simply press the Q.View button.

**3** If you want to return to channel 18, press the button again. Use this function, you can easily change between the channel you are using and the channel you used last time.

18
----

8
---

18
----

## Setting Up Your Remote Control

After it has been set up properly, your remote control can operate in six different modes: TV, VCR, CABLE, DVD, SETBOX or AUDIO. Pressing the corresponding button on the remote control allows you to switch between these modes, and control whichever piece of equipment you choose.

### Note:

The remote control might not be compatible with all DVD Players, VCRs and Cable boxes.



### Setup the desired device code

- 1 Find one code number from code list according to device's brand and model. (See P41-P43 of the remote codes)
- 2 Press SELECT button continuously to select desired device.
- 3 Press and hold OK button, then press SELECT button about 5 seconds, till LED is on. Release OK and SELECT buttons. LED flashes with the speed of 2 times one second. It indicates the remote controller to enter Setup Mode.
- 4 Using the number buttons on the remote controller, enter three digits of code number in order. The LED will flash once for each of press.
- 5 If the code number is correct, LED will keep on for 3 seconds then flash with the speed of twice per second. You may press OK or PLAY to test if it can control your device. If no, turn to procedure step 4 to try another code number. If ok, you may press OK to exit Setup Mode, the code number will be stored. LED is off. If the code number is incorrect, LED will flash with the speed of 4 times per second for 3 seconds, then flash with the speed of 2 times per seconds. You may turn to step 4 to try another code number.
- 6 During Setup mode, press the other keys except digit keys(0-9) or no any key is pressed, it will exit Setup Mode or with LED off.

### Search Mode (Manual Search)

- 1 Turn on the desired device. If the device is VCR or DVD, etc, you should insert tape or disc into the device.
- 2 Press SELECT button continuously to select desired device.
- 3 Press and hold OK, then press SELECT about 3 seconds till LED is on (aim it at the remote control sensor on the device). Release the two buttons. LED flashes with the speed of twice per second, which indicates the remote controller to enter Setup Mode.
- 4 Press and release CH+/- button, it will send POWER IR signal of next or previous code number. LED flashes.
- 5 During searching, if the device switch off, it indicates the code is searched successfully, Press OK button to confirm.
- 6 During manual searching mode, press any key except OK button or no any key is pressed within 30 seconds, it will exit Setup Mode.

### Search Mode(Auto Search)

- 1 Turn on the device. If the device is VCR or DVD, etc, you should insert tape or disc into the device.
- 2 Press SELECT button continuously to select desired device.
- 3 Press and hold OK button, then press SELECT button about 3 seconds till LED is on (aim it at the remote control sensor on the device).
- 4 Press MUTE button to enter **Auto Search Mode**.
- 5 During searching, if the device switch off, it indicates the code is searched successfully, Press OK button to confirm.
- 6 During Auto Search Mode, Press any key except OK button, it will exit Auto Search Mode. LED is off.

## Setting Up Your Remote Control



### Code Display Mode

- 1 Press and release SELECT button to desired device.
- 2 Press and hold OK button, then press SELECT button about 3 seconds till LED is on. Release 2 keys. LED flashes with the speed of twice per second.
- 3 Enter [9][8][0] in turn to enter Code Display Mode . LED is off.
- 4 Press and release [1] once, LED will flash. The times LED flashes is the first digit of code number.(no flash = 0)
- 5 Press and release [2] once, LED will flash. The times LED flashes is the second digit of code number. (no flash = 0)
- 6 Press and release [3] once, LED will flash. The times LED flashes is the third digit of code number. (no flash = 0)
- 7 Code Display process is end and exit the mode automatically.
- 8 Under Code Display Mode, the remote controller will be no reaction to other buttons pressed, and will automatically exit the mode if no any key is pressed within 10seconds.



## Remote Control Codes

### TV

NO.	Brand	Code	1	2	3	4	5	6	7	8	9	10	11	12
148	Squareview	1	172											
149	SSS	2	176	140										
150	Starlite	1	176											
151	Supre-Macy	1	148											
152	Supreme	1	133											
153	Sylvania	7	018	019	010	080	151	144	191					
154	Symphonic	5	030	046	047	041	172							
155	Tandy	1	159											
156	Tatung	2	152	135										
157	TCL	12	086	087	089	090	093	094	095	098	107	108	109	121
	TCL	1	132											
158	Technics	1	184											
159	Technol Ace	1	175											
160	Techwood	2	153	135										
161	Teknika	12	151	176	164	154	175	153	140	137	158	147	178	189
162	Telefunken	1	153											
163	TMK	3	174	153	173									
164	Toshiba	10	067	026	021	059	066	082	166	167	154	222		
165	Totevision	1	147											
166	Trical	1	168											
167	Universal	1	143											
168	Vector Research	1	144											
169	Victor	1	150											
170	Videch	3	038	010	019									
171	Vidikron	2	151	183										
172	Vidtech	2	174	140										
173	Viking	2	148	189										
174	Wards	4	020	010	022	019								
175	White Westinghouse	3	198	203	204									
176	Words	11	151	144	174	141	175	153	140	137	170	143	160	
177	Yamaha	2	144	140										
178	Zenith	7	016	017	138	198	204	137	158					
179	Zonda	1	135											
180	Others	12	034	064	065	068	069	070	071	072	076	078	169	170
	Others	1	171											

### DVD

NO.	Brand	Code	1	2	3	4	5	6	7	8	9	10	11	12
1	Aiwa	2	032	016										
2	Akai	2	089	126										
3	Apex	2	127	129										
4	Daewoo	4	046	121	124	134								
5	Dansai	1	005											
6	Denon	4	023	034	094	108								
7	Elta	2	117	123										
8	Emerson	1	090											
9	Fisher	1	104											
10	GE	2	114	133										
11	Go-Video	1	098											
12	Harman/Kardon	1	035											
13	Hitachi	4	025	096	106	120								
14	Integra	1	109											
15	JVC	4	024	054	97	131								
16	KEF	1	001											
17	Kenwood	2	094	113										
18	KLH	1	027											
19	Konka	4	100	101	412	102								
20	Lasonic	1	125											
21	Magnavox	2	092	099										
22	Marantz	2	092	099										
23	Mitsubishi	1	095											
24	Mustek	1	115											
25	NAD	1	116											
26	Nakamichi	1	135											
27	Onkyo	2	033	109										
28	Optimus	2	096	120										
29	Oritron	1	103											
30	Panasonic	12	019	023	044	045	051	052	053	059	062	087	087	094
31	Philips	5	029	086	092	099	110							
32	Pioneer	6	021	036	038	050	096	120						
33	Profilo	2	004	006										
34	PS2	2	011	014										
35	Radioshack	4	88	122	132	136								
36	RCA	9	022	068	073	088	114	122	132	133	136			
37	Sampo	1	105											
38	Samsung	4	031	058	098	128								
39	SEG	1	112											
40	Sharp	3	028	065	091									
41	Sherwood	1	111											
42	Shinco	3	039	114	133									
43	Skyworth	2	007	015										
44	Sony	12	018	040	041	042	047	048	049	057	083	084	085	077
	Sony	7	078	079	067	081	008	009	093					
45	Sylvania	3	037	061	066									
46	Teac	1	120											
47	Theta Digital	2	096	120										
48	Thomson	3	030	012	017									
49	Toshiba	7	020	055	056	063	92	436	130					
50	X Box	3	002	003	010									
51	Yamaha	3	023	094	107									
52	Yamakawa	1	119											
53	Zenith	4	026	064	090	118								
54	Others	11	043	060	069	070	071	072	074	075	076	080	082	

## Remote Control Codes

### VCR

NO.	Brand	Code	1	2	3	4	5	6	7	8	9	10	11	12
1	Admiral	1	030											
2	Aiwa	3	041	050	035									
3	Akai	3	052	053	054									
4	Audio Dynamic	2	017	040										
5	Bell & Howell	2	033	046										
6	Broksonic	3	020	022	017									
7	Canon	2	012	011										
8	Citizen	1	035											
9	Craig	2	018	035										
10	Curtis Mathis	3	007	041	012									
11	Daewoo	4	044	015	012	064								
12	DBX	3	017	039	040									
13	Dimensia	1	007											
14	Emerson	8	044	022	023	019	020	021	041	058				
15	Fisher	4	033	037	038	036								
16	Funai	1	041											
17	General Electric	4	032	007	012	062								
18	GO VIDEO	3	051	042	043									
19	Goldstar/LG	1	035											
20	Hitachi	3	011	007	008									
21	HQ	1	015											
22	Instant Replay	2	012	011										
23	JC Penny	7	012	008	007	033	017	039	040					
24	JVC	6	017	047	048	049	039	040						
25	Kenwood	4	017	039	035	040								
26	LXI(Sears)	8	041	035	008	036	037	033	038	052				
27	Magnavox	5	013	011	012	010	063							
28	Marantz	3	017	039	040									
29	Marta	1	035											
30	Memorex	2	012	038										
31	Minolta	2	008	007										
32	Mitsubishi/MGA	8	026	027	028	029	056	057	065	059				
33	Multitech	3	028	041	024									
34	NEC	3	017	039	040									
35	Olympic	2	012	011										
36	Optimus	1	027											
37	Orion	1	055											
38	Panasonic	5	009	010	011	012	060							
39	Pentax	2	008	007										
40	Philco	4	011	012	044	020								
41	Philips	5	035	013	011	012	063							
42	Pioneer	1	011											
43	Quasar	5	011	012	009	010	006							
44	RCA/PROSCAN	8	007	008	011	012	013	014	015	016				
45	Realistic	6	012	033	031	038	027	041						
46	Samsung	3	025	016	024									
47	Sansui	1	017											
48	Sanyo	5	033	038	046	044	035							
49	Scott	8	015	016	024	038	026	027	028	029				
50	Sharp	2	030	031										
51	Shintom	1	018											
52	Signature 2000	2	041	030										
53	Singer	1	018											
54	Sony	1	001											
55	Sylvania	4	013	011	012	041								
56	Symphonic	1	041											
57	Tashiro	1	035											
58	Tatung	3	017	039	040									
59	Teac	4	017	039	041	040								
60	Technics	2	012	011										
61	Toshiba	3	015	014	052									
62	Wards	5	030	031	038	034	035							
63	Yamaha	4	033	017	039	040								
64	Zenith	1	034											
65	Others	4	002	003	004	005								

### SETBOX

NO.	Brand	Code	1	2	3	4	5	6	7	8	9	10	11	12
1	Alphastar	1	028											
2	Chaparral	2	015	011										
3	Echostar	3	029	035	017									
4	Expressvu	1	029											
5	General Instrument	3	018	021	034									
6	Hitachi	2	031	005										
7	Homecable	1	016											
8	HTS	1	029											
9	Hughes Net.Sys.	2	027	004										
10	IQ Prism	1	014											
11	Jerrold	2	018	021										
12	JVC	1	029											
13	Magnavox	3	025	024	026									
14	Memorex	1	025											
15	Next Level	1	034											
16	Panasonic	2	023	003										
17	Philips	4	025	024	036	026								
18	Primestar	2	018	021										
19	Radioshack	1	034											
20	RCA	4	020	013	032	019								
21	RCA/Proscan	2	002	007										
22	Realistic	1	010											
23	Samsung	1	037											
24	Scientific Atlanta	2	008	009										
25	Sony	2	022	001										
26	Starchoice	1	034											
27	STS	1	014											
28	Toshiba	4	027	030	012	006								
29	Uniden	4	025	024	010	016								
30	Zenith	1	033											

### CABLE

NO.	Brand	Code	1	2	3	4	5	6	7	8	9	10	11	12
1	Hamlin/Regal	5	022	023	024	025	026							
2	Hitachi	1	005											
3	Hughes	1	004											
4	Jerrold/G.I	12	031	001	002	003	004	005	006	007	008	018	022	032
	Jerrold/G.I.	1	015											
5	Motorola	1	015											
6	OAK	3	027	028	029									
7	Panasonic	4	019	020	021	003								
8	Philips	1	016											
9	Pioneer	2	014	015										
10	RCA/Proscan	2	002	007										
11	Scientific Atlanta	4	009	010	011	014								
12	Sony	2	013	001										
13	Tocom	3	031	016	017									
14	Toshiba	1	006											
15	Zenith	2	012	013										

## Remote Control Codes

### AUDIO TYPES

#### RECEIVER

NO.	Brand	Code	1	2	3	4	5	6	7	8	9	10	11	12
1	Aiwa	2	022	023										
2	Denon	4	010	024	027	028								
3	Fisher	1	011											
4	JVC	2	019	020										
5	Kenwood	3	015	016	025									
6	Magnavox	1	021											
7	Marantz	1	029											
8	Panasonic	1	008											
9	Philips	1	017											
10	Pioneer	2	006	018										
11	Sanyo	1	011											
12	Sharp	1	028											
13	Sherwood	2	012	013										
14	Sony	2	001	002										
15	Technics	2	007	026										
16	Yamaha	2	014	030										

#### TAPE

NO.	Brand	Code	1	2	3	4	5	6	7	8	9	10	11	12
1	Denon	2	055	056										
2	Fisher	1	057											
3	GoldStar/LG	1	054											
4	Pioneer	1	052											
5	Sanyo	1	057											
6	Sony	4	049	050	051	058								
7	Technics	1	053											

#### MD/DAT

NO.	Brand	Code	1	2	3	4	5	6	7	8	9	10	11	12
1	Denon	1	061											
2	JVC	2	063	066										
3	Kenwood	1	062											
4	Marantz	1	065											
5	Panasonic	1	064											
6	Sansui	1	067											
7	Sony	2	059	060										
8	Teac	1	063											

#### CD

NO.	Brand	Code	1	2	3	4	5	6	7	8	9	10	11	12
1	Denon	2	038	039										
2	GoldStar/LG	1	037											
3	JVC	1	048											
4	Kenwood	2	044	045										
5	Magnavox	1	046											
6	Panasonic	1	036											
7	Philips	1	046											
8	Pioneer	2	037	047										
9	Sanyo	1	040											
10	Sherwood	2	041	042										
11	Sony	3	031	032	033									
12	Technics	1	035											
13	Yamaha	1	043											



## Maintenance

- Early malfunctions can be prevented. Careful and regular cleaning can extend the amount of time you will have your new TV. Be sure to turn the power off and unplug the power cord before you begin any cleaning.

### Cleaning the Screen

1. Here's a great way to keep the dust off your screen for a while. Wet a soft cloth in a mixture of lukewarm water and a little fabric softener or dish washing detergent. Wring the cloth until it's almost dry, and then use it to wipe the screen.
2. Make sure the excess water is off the screen, and then let it air-dry before you turn on your TV.

### Cleaning the Cabinet

To remove dirt or dust, wipe the cabinet with a soft, dry, lint-free cloth. Please be sure not to use a wet cloth.

### Extended Absence

If you expect to leave your TV dormant for a long time (such as a vacation), it's a good idea to unplug the power cord to protect against possible damage from lightning or power surges.

# Product Specifications

Resolution	1366X768(Dot)
Power requirement	120V~ , 60Hz
Color System	NTSC, ATSC, Clear QAM
External Antenna Impedance	75 ohm
Color	16,770,000 (256 steps of each R, G and B)
Operating Temperature Range	32 ~ 104°F (0 ~ 40°C)
Operating Humidity Range	Less than 80%
Maximum Elevation	6561 feet (2000m)

MODEL	Dimensen(WXDXH) Unit:::inches/mm (Including stand)	Weight (pounds / kg)
HL26S	31.3X11.2X20.3inches 794X285X515 mm	37.5/17.0
HL32S	37.0X11.2X23.4 inches 940X285X595 mm	52.9/24.0
HL37S	43.1X12.8X27.0 inches 1096X325X687mm	62.8/28.5
HL42S	44.5X13.3X29.5inches 1131X337X750mm	72.8/33.0
HL26B	26.7X9.7X20.7inches 679X246X525 mm	27.6/12.5
HL32B	31.9X9.7X24.4 inches 811X246X621mm	35.3/16.0
HL37B	37.2X12.2X28.0 inches 946X310X710 mm	50.7/23.0
HL40B	39.9X12.2X29.1inches 1014X310X738mm	55.1/25.0
HL42B	41.9X12.2X31.5inches 1065X310X800mm	57.3/26.0

■ The specifications shown above may be changed without prior notice for quality improvement.

# Troubleshooting

For the sake of time and cost, it is strongly recommended that you check out the problem by yourself according to the instructions listed hereunder before contacting the after-sales service for technical assistance.

No picture, no sound	Verify if the television is properly plugged. Verify if the television is properly supplied power. Verify if electricity is available.
Blank screen	Verify if correct signals are input. Press INPUT button to change signal input to TV input. Restart the television if power supply is interrupted.
No sound	Press Mute button and verify if Mute mode is set. Switch to other channel and verify if the same problem happens. Press VOL+ button to see if the problem can be solved.
Poor sound	Verify if sound system is correct. Refer to some chapter for adjust.
No picture in some channel	Verify if correct channel is selected. Adjust the antenna. Make adjustments by Fine Tune and Manual Scan.
No color for some channel program (black and white)	Verify if the same problem exists in other channels. Check out of picture and sound systems. Refer to relative instructions in the Manual for color adjust.
Spots with some or all pictures	Verify if the antenna is correctly connected. Verify if the antenna is in good condition. Make fine adjustment of channel.
Horizontal/vertical bars or picture shaking	Check for local interference such as an electrical appliance or power tool.
Television out of control	Disconnect the television from power supply and, 10 seconds later, connect the television to the power supply. If the problem still exists, contact authorized after-sales service for technical assistance.

*Note: Do not leave the television with static picture in an extended period as it may result in residual image on your television screen.*

*Note: Production of the plasma screen requires high and precision technologies. However, there might be some dark or bright (red, blue or green) spots, or some anomalous stripes or spots. This is not defect. If the TV set is used in an area 2,400 meters above the sea level where the air pressure is below 750hpa, the picture on the plasma screen may be affected and a muffled sound might be produced. These phenomena might happen in the area 1,500 meters above the sea level. This is resulted from difference between air pressures inside and outside the display. This is not a defect covered by the limited warranty.*

# Warranty

This Haier brand product, when shipped in its original container, will be free from defective workmanship and materials, and agrees that it will, at its option, either repair the defect or replace the defective product with a new or re-manufactured equivalent at no charge to the purchaser, for parts or labor for the periods set forth below:

This warranty does not apply to the appearance of the product or the exterior of the product, which has been damaged or defaced, altered or modified in design or construction. It does not apply to the additional excluded items set forth below:

The warranty commences on the date the item was purchased and the original purchase receipt must be presented to the authorized service center before warranty repairs are rendered.

The limited warranty described herein is in addition to whatever implied warranties may be granted to purchasers by law. **ALL IMPLIED WARRANTIES INCLUDING THE WARRANTIES OF MERCHANTABILITY AND FITNESS FOR USE ARE LIMITED TO THE PERIOD(S) FROM THE DATE OF PURCHASE SET FORTH BELOW.** Some states do not allow limitations on how long an implied warranty lasts, so the above limitation may not apply to you.

Neither the sales personnel of the seller nor any other person is authorized to make any warranties other than those described herein, or to extend the duration of any warranties beyond the time period described herein on behalf of Haier.

The warranties described herein shall be the sole and exclusive warranties granted by Haier and shall be the sole and exclusive remedy available to the purchaser. Correction of defects in the manner and for the period of time described herein, shall constitute complete fulfillment of all abilities and

Responsibility of Haier to the purchaser with respect to the product, and shall

constitute full satisfaction of all claims, whether based on contract, negligence, strict duality or otherwise. In no event shall Haier be liable, or in any way responsible for any damages or defects in the product which were caused by repairs or attempted repairs performed by anyone other than an authorized service center or dealer; nor shall Haier be liable, or in any way responsible for incidental or consequential economic or property damage. Some states do not allow the exclusion of incidental or consequential damages, so that above exclusion may not apply to you.

**THIS WARRANTY GIVES YOU SPECIFIC LEGAL RIGHTS. YOU MAY ALSO HAVE OTHER RIGHTS WHICH VARY FROM STATE TO STATE.**

Warranty period for this product: one year parts and labor.

Additional items excluded from warranty coverage: non-rechargeable batteries.

Where to obtain service: For the location of the nearest Haier authorized service center or to obtain product literature, accessories, supplies or customer assistance, please call 1-877-337-3639.

What to do to obtain service: ship or carry in your product to an authorized service dealer or center. Be sure to have proof of purchase. If you ship the product, be sure it is packaged carefully.

Haier America  
New York, NY 10018

# Haier

0090506979B (01)

## Free Manuals Download Website

<http://myh66.com>

<http://usermanuals.us>

<http://www.somanuals.com>

<http://www.4manuals.cc>

<http://www.manual-lib.com>

<http://www.404manual.com>

<http://www.luxmanual.com>

<http://aubethermostatmanual.com>

Golf course search by state

<http://golfingnear.com>

Email search by domain

<http://emailbydomain.com>

Auto manuals search

<http://auto.somanuals.com>

TV manuals search

<http://tv.somanuals.com>