

Haier

TFT-LCD TV *OWNER'S MANUAL*

Please READ this manual carefully before operating your TV, and retain it for future reference.

Haier

Haier

MODELS:

HL37E

HL42E

HL47E

HL52E

Haier



WARNING

RISK ELECTRIC SHOCK
DO NOT OPEN



WARNING : To reduce the risk of electric shock do not remove cover or back.
No user-serviceable parts inside refer service to qualified service personnel.

Safety of operators has been taken into consideration at the design and manufacture phase, but inappropriate operation may cause electric shock or fire. To prevent the product from being damaged, the following rules should be observed for the installation, use and maintenance of the product. Read the following safety instruction before starting the operation.

The User Manual uses the following symbols to ensure a safe operation and prevent any damage to operators or properties:



THIS SYMBOL INDICATES THAT HIGH VOLTAGE IS PRESENT INSIDE. IT IS DANGEROUS TO MAKE ANY KIND OF CONTACT WITH ANY INSIDE PART OF THIS PRODUCT.



THIS SYMBOL INDICATES THAT THERE ARE IMPORTANT OPERATING AND MAINTENANCE INSTRUCTIONS IN THE LITERATURE ACCOMPANYING THE APPLIANCE.

FCC STATEMENT

This equipment has been tested and found to comply with the limits for a Class B digital device, pursuant to Part 15 of the FCC Rule. These limits are designed to provide reasonable protection against harmful interference in a residential installation. This equipment generates, use and can radiate radio frequency energy and, if not installed and used in accordance with the instructions, may cause harmful interference to radio communications. However, there is no guarantee that interference will not occur in a particular installation. If this equipment does cause harmful interference to radio or television reception, which can be determined by turning the equipment off and on, the user is encouraged to try to correct the interference by one or more of the following measures:

- *Reorient or relocate the receiving antenna.
- *Increase the separation between the equipment and receiver.
- *Connect the equipment into an outlet on a circuit different from that to which the receiver is connected.
- *Consult the dealer or an experienced radio/TV technician for help.

This device complies with Part 15 of the FCC Rules. Operation is subject to the following two conditions: (1) This device may not cause harmful interference, and (2) this device must accept any interference received, including interference that may cause undesired operation.

FCC CAUTION:

To assure continued compliance and possible undesirable interference, the provided ferrite cores must be used when connecting this plasma display to video equipment; and maintain at least 40cm spacing to other peripheral device.

CANADIAN NOTICE:

This Class B digital apparatus complies with Canadian ICES-003.

IMPORTANT SAFETY INSTRUCTIONS

Read all of the instructions before using this appliance. When using this appliance, always exercise basic safety precautions, including the following:

- 1) Read these instructions.
- 2) Keep these instructions.
- 3) Heed all warnings.
- 4) Follow all instructions.
- 5) Do not use this apparatus near water.
- 6) Clean only with dry cloth.
- 7) Do not block any ventilation openings. Install in accordance with the manufacturer's instructions.
- 8) Do not install near any heat sources such as radiators, heat registers, stoves, or other apparatus (including amplifiers) that produce heat.
- 9) Do not defeat the safety purpose of the polarized or grounding-type plug. A polarized plug has two blades with one wider than the other. A grounding type plug has two blades and a third grounding prong. The wide blade or the third prong are provided for your safety. If the provided plug does not fit into your outlet, consult an electrician for replacement of the obsolete outlet.
- 10) Protect the power cord from being walked on or pinched particularly at plugs, convenience receptacles, and the point where they exit from the apparatus.
- 11) Only use attachments/accessories specified by the manufacturer.
- 12) Use only with the cart, stand, tripod, bracket, or table specified by the manufacturer, or sold with the apparatus. When a cart is used, use caution when moving the cart/apparatus combination to avoid injury from tip-over.
- 13) Unplug this apparatus during lightning storms or when unused for long periods of time.
- 14) Refer all servicing to qualified service personnel. Servicing is required when the apparatus has been damaged in any way, such as power-supply cord or plug is damaged, liquid has been spilled or objects have fallen into the apparatus, the apparatus has been exposed to rain or moisture, does not operate normally, or has been dropped.
- 15) **WARNING-To Reduce The Risk Of Fire Or Electric Shock, Do Not Expose This Apparatus To Rain Or Moisture.** Apparatus shall not be exposed to dripping or splashing and no objects filled with liquids, such as vases, shall be placed on the apparatus.

PORTABLE CART WARNING
(symbol provided by RETAC)



S3126A

The apparatus shall not be exposed to dripping or splashing and that no objects filled with liquids, such as vases, shall be placed on the apparatus.

The mains plug is used as the disconnect device, remain it readily operable during the apparatus normal use.

SAVE THESE INSTRUCTIONS

Thank you for using our Haier product. This easy-to-use manual will guide you in getting the best use of your product. Remember to record the model and serial number. They are on label in back of the unit.

Model number

serial number

Date of purchase

Staple your receipt to your manual. **You will need it to obtain warranty service.**

Contents

Warning	2	Time Menu	
Safety Instructions	3	Date /Time setting.....	26
Introduction		Timer on setting.....	26
Controls	6	Timer offsetting.....	26
Connection Options	7	Sleep Timer setting.....	27
Universal Remote Controller	8	Time zone setting.....	27
Installation		Daylight Saving setting.....	27
Accessories	9	Function Menu	
Antenna Connection	9	Closed Captions.....	28
VCR Connection	10	CC mode.....	28
External A/V Source Setup	11	NTSC Caption.....	28
DVD Connection	11	DTV Caption.....	28
DTV Connection.....	12	DTV Caption Style.....	29
Digital Audio Output	12	OSD Timeout.....	29
PC Connection	13	Blue screen.....	29
Monitor Out Setup	14	OSD transparency.....	29
HDMI	14	Adjust Menu	
Cable Sample.....	15	Screen Setup for PC mode.....	30
Connecting Headphones	16	Lock Menu	
Power source.....	16	Parental Control rating and categories.....	31
Operation		Others Functions	
Switching On/Off the TV set	17	Brief Info.	34
Choose the Menu Language	17	Quick program view.....	34
Choose the input Source.....	17	Setting up your remote control	35
Channel Menu		USB system	37
Automatic Scan	18	Maintenance	41
Manual Scan	19	Product Specifications	42
Fine Tune.....	19	Troubleshooting	43
Edit Program.....	20	Warranty	44
Rename	20		
Select the desired program.	21		
Select the desired sound	21		
Mute	21		
Video Menu			
How to select picture modes.....	22		
How to customize your own picture status	22		
Aspect Ratio Control	23		
Audio Menu			
How to select audio modes.....	24		
How to customize your own audio status	24		
SAP Broadcasts Setup.....	25		

Controls

- This is a simplified representation of front panel.
- Here shown may be somewhat different from your TV.

Front panel controls

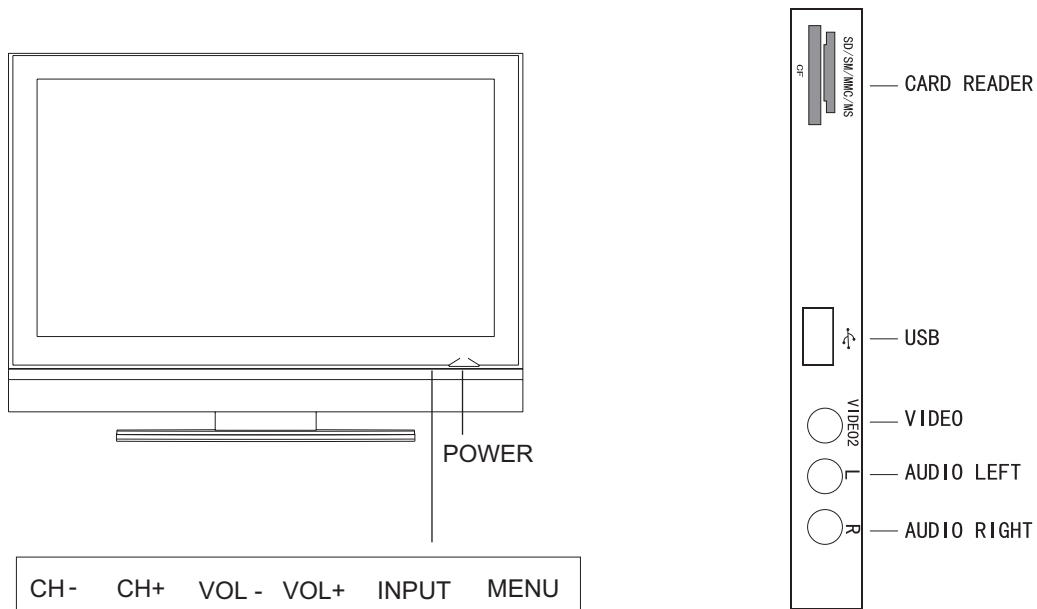

- 1.CH-/+:** Program minus and plus, menu options
- 2.VOL-/+:** Volume increase and decrease, menu reset and entry
- 3.INPUT:** all input resource display and OK confirm:
- 4..MENU:** Menu display
- 5.POWER:** Is used to activate the display or return to standby mode

Connection Options

Left side connetions

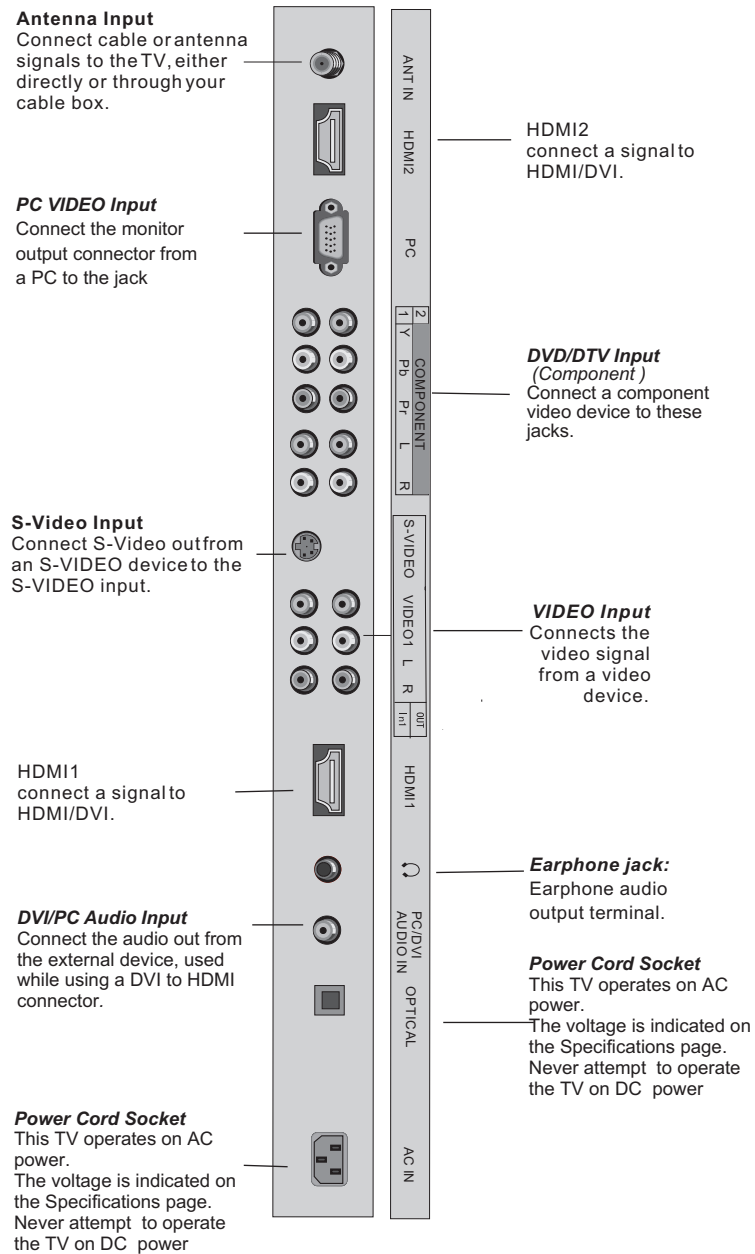

Remote Controller

- The remote controller cannot be operated unless the batteries are properly loaded.
- When using the remote control, aim it at the remote control sensor on the TV.

Function introduction

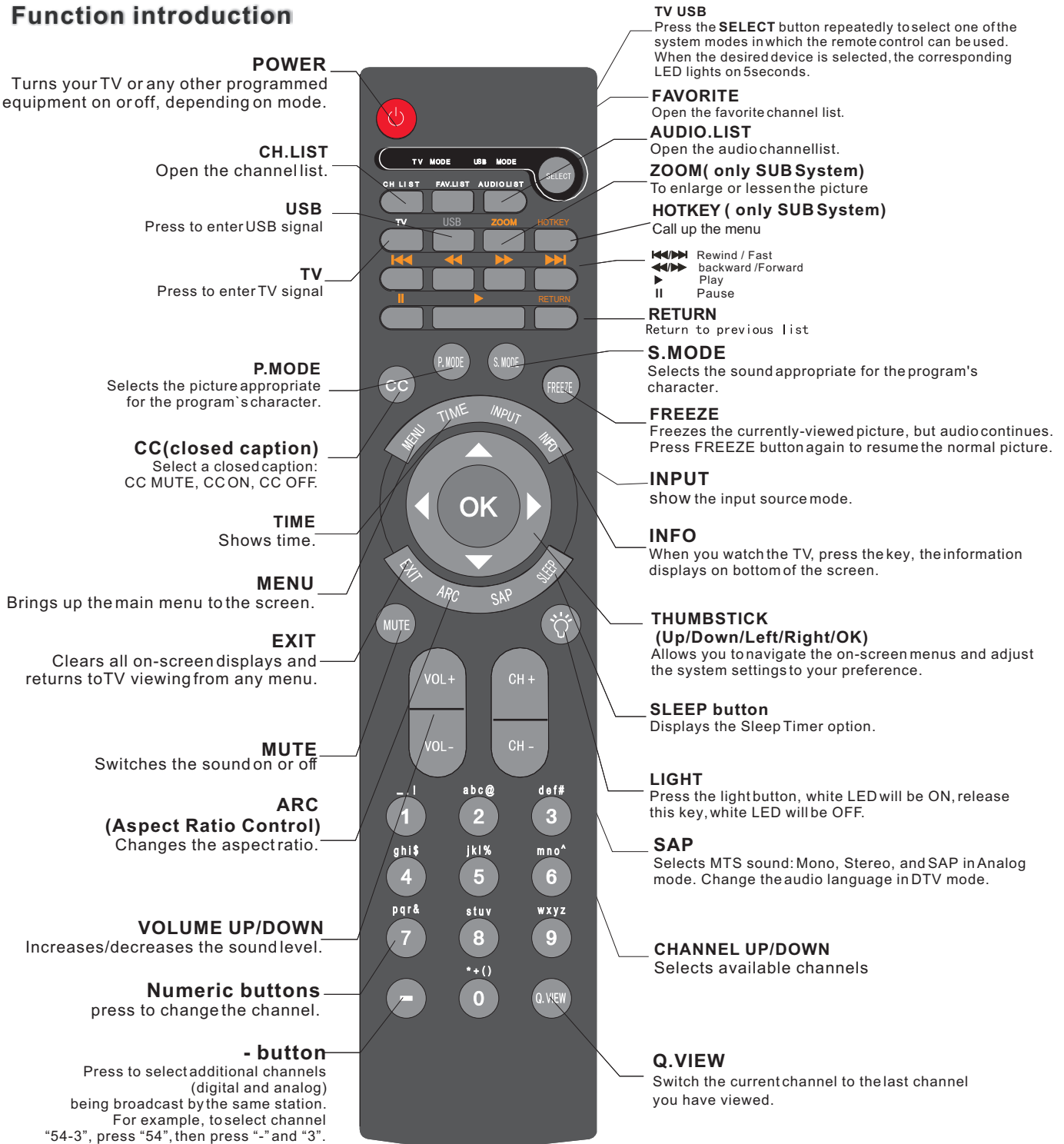

Note: For DVD function see page 35.

External Equipment Connections

Accessories



Remote controller

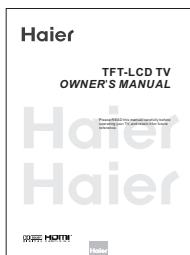

Owner`s manual

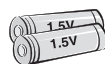

Alkaline battery(AAA)×2



Power cable

Antenna Connection

Generally speaking, to enjoy a clearer picture, we recommend that you use a CATV system or an outdoor antenna .In different places, the suitable antenna type and position are different.

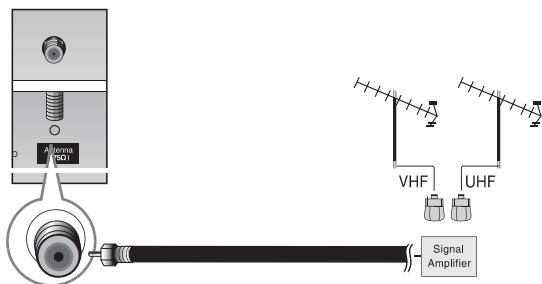
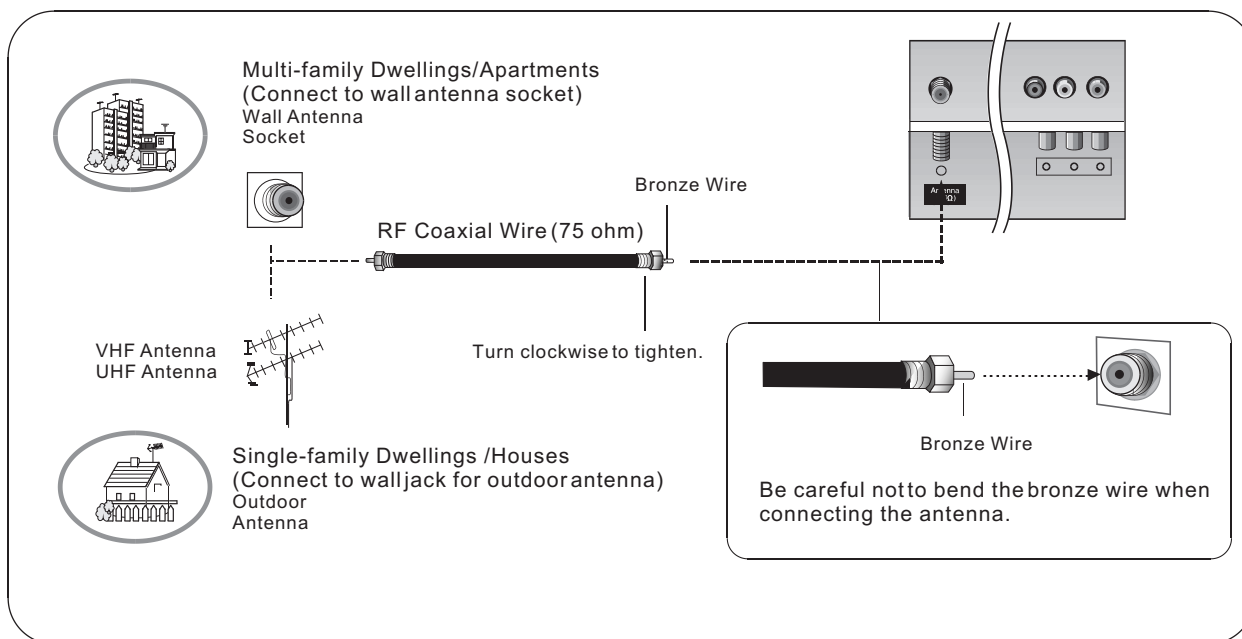

- To improve the picture quality in a poor signal area, please purchase a signal amplifier and install properly.
- If the antenna needs to be split for two TV`s, install a "2-Way Signal Splitter" in the connections.
- If the antenna is not installed properly, contact your dealer for assistance.

External Equipment Connections

NOTE: All cables shown are not included with the TV.

Choose Your Connection

There are several ways to connect your television, depending on the components you want to connect and the quality of the signal you want to achieve. The following are examples of some ways to connect your TV. Choose the connection which is best for you.

VCR connection

- To avoid picture noise (interference), leave an adequate distance between the VCR and TV.

Connection Option 1

Set VCR output switch to channel 3 or 4 and then tune the TV to the same channel number.

Connection Option 2

1. Connect the audio and video cables from the VCR's output jacks to the TV input jacks, as shown in the figure.

When connecting the TV to VCR, match the jack colors (Video = yellow, Audio Left = white, and Audio Right = red).

If you connect an S-VIDEO output from VCR to the S-VIDEO input, the picture quality is improved; compared to connecting a regular VCR to the Video input.

2. Insert a video tape into the VCR and press PLAY on the VCR. (Refer to the VCR owner's manual.)

3. Select the input source with using the INPUT button on the remote control, and then press ▲/▼ button to select the source, press the OK button to confirm.

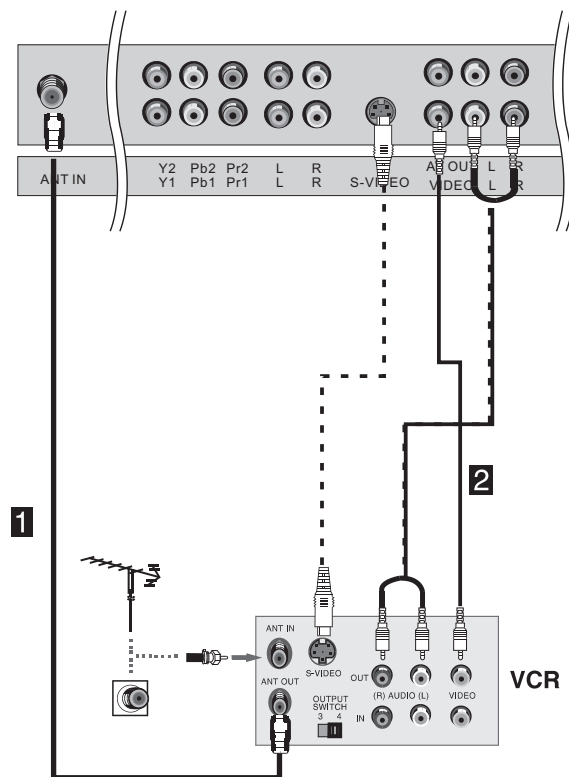

External Equipment Connections

External A/V Source Setup

How to connect

Connect the audio and video cables from the external equipment's output jacks to the TV input jacks, as shown in the figure. When connecting the TV to external equipment, match the jack colors (Video = yellow, Audio Left = white, and Audio Right = red).

How to use

1. Select the input source with using the INPUT button on the remote control.
2. Press the ▲/▼ button to select the desired source.
3. Press the ok button to confirm
4. Operate the corresponding external equipment.

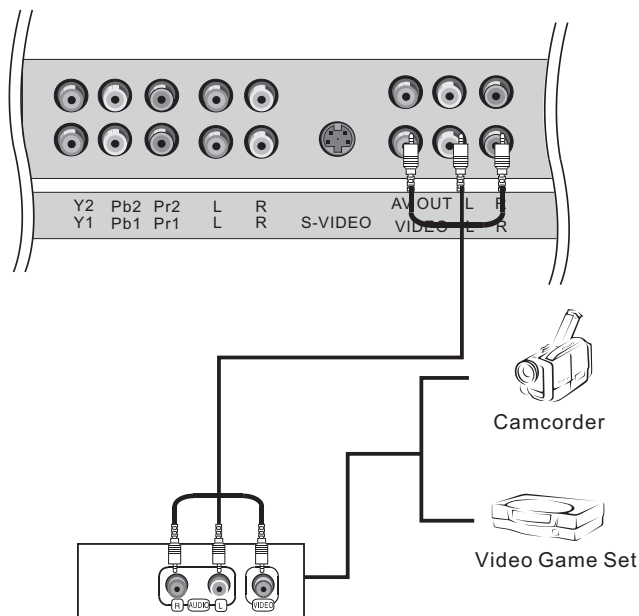

DVD connection

How to connect

1. Connect the DVD video outputs (Y, Pb/Cb, Pr/Cr) to the Y, Pb, Pr jacks on the TV and connect the DVD audio outputs to the YPbPr Audio IN jacks on the TV, as shown in the figure.
 2. If your DVD only has an S-VIDEO output jack, connect this to the S-VIDEO input on the TV, as shown in the figure.

NOTE: If your DVD player does not have component video output, use S-Video.

How to use

1. Turn on the DVD player, insert a DVD.
2. Use the INPUT button on the remote control to select YPbPr mode.
3. Press Play button on external equipment for program play.
4. Refer to the DVD player's manual for operating instructions.

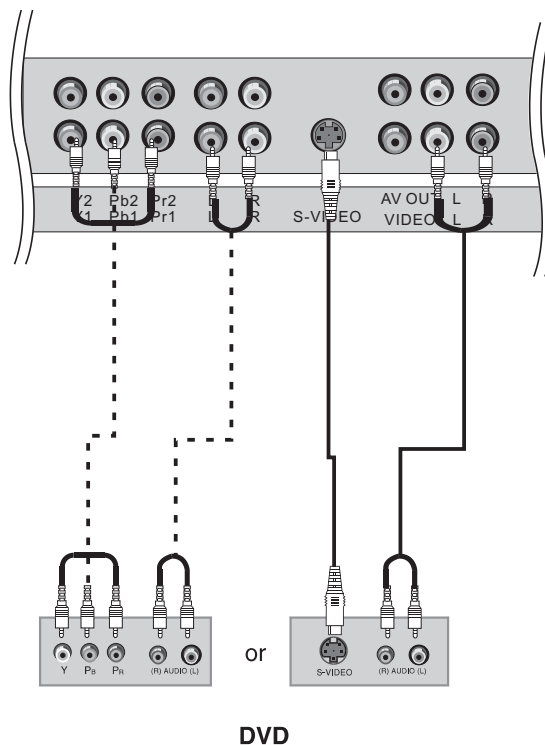

■ Component Input ports

To get better picture quality, connect a DVD player to the component input ports as shown below.

Component ports on the TV	Y	Pb	Pr
Video output ports on DVD player	Y	Pb	Pr
	Y	B-Y	R-Y
	Y	Cb P _B	Cr P _R

External Equipment Connections

DTV connection

- This TV can receive Digital Over-the-air/Cable signals without an external digital set-top box. However, if you do receive Digital signals from a digital set-top box or other digital external device, refer to the figure as shown below.
- This TV supports HDCP (High-bandwidth Digital Contents Protection) protocol for Digital Contents (480p, 720p, 1080i).

How to connect

Use the TV's (Y, Pb, Pr), PC or HDMI jack for video connections, depending on your set-top box connector. Then, make the corresponding audio connections.

How to use

1. Turn on the digital set-top box. (Refer to the owner's manual for the digital set-top box.)
2. Use INPUT on the remote control to select YPbPr, PC, or HDMI source.

Signal	YPbPr	HDMI/DVI
480i	Yes	Yes
480p	Yes	Yes
720p	Yes	Yes
1080i	Yes	Yes

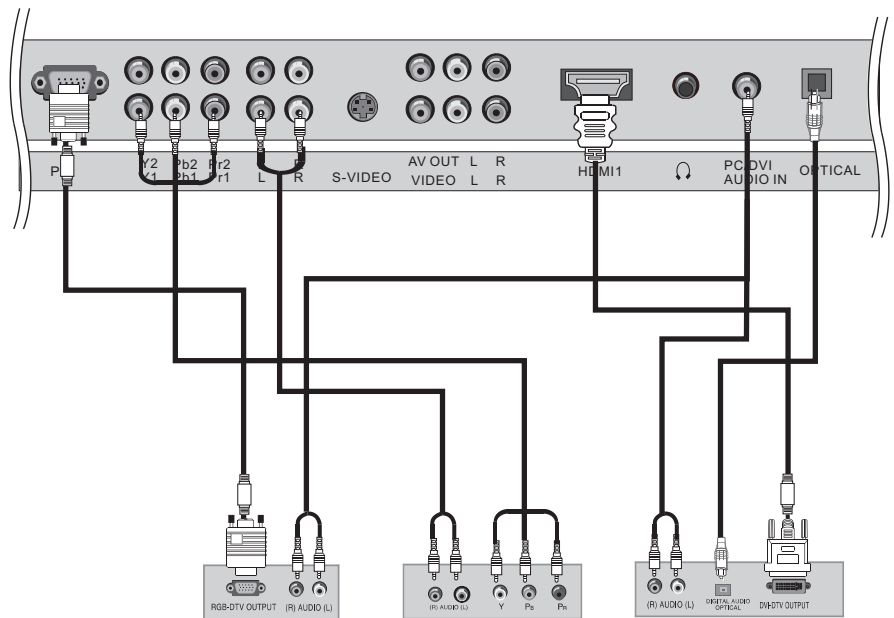

Digital Set-top Box

Audio Output

Send the TV's audio to external audio equipment (stereo system) via the Audio Output (Optical) port.

How to connect

1. Connect one end of an optical cable to the TV Audio (Optical) Output port.
 2. Connect the other end of the optical cable to the digital audio (optical) input on the audio equipment.
- See the external audio equipment instruction manual for operation.

Note: When connecting with external audio equipments, such as amplifiers or speakers, please turn the TV speakers off.

Caution: Do not look into the optical output port. Looking at the laser beam may damage your vision.

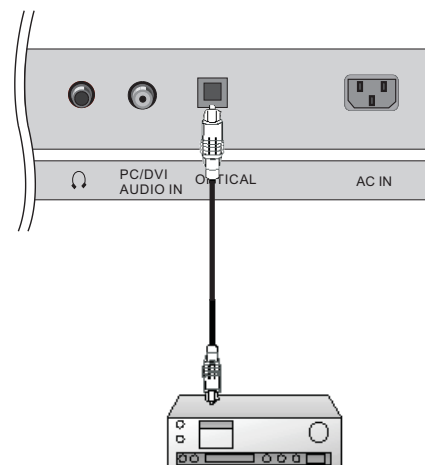

External Equipment Connections

PC connection

How to connect

1. To get the best picture quality, adjust the PC graphics card to 1024x768 .
2. Use the TV's PC or DVI (Digital Visual Interface) Audio IN port for video connections, depending on your PC connector.
 - If the graphic card on the PC does not output analog and digital RGB simultaneously, connect only one of either PC IN or DVI IN to display the PC on the TV.
 - If the graphic card on the PC does output analog and digital RGB simultaneously, set the TV to either PC or DVI; (the other mode is set to Plug and Play automatically by the TV.)
3. Then, make the corresponding audio connection. If using a soundcard, adjust the PC sound as required.

How to use

1. Turn on the PC and the TV.
2. Turn on the display by pressing the POWER button on the TV's remote control.
3. Use INPUT on the remote control to select PC or HDMI source.
4. Check the image on your TV. There may be noise associated with the resolution, vertical pattern, contrast or brightness in PC mode. If noise is present, change the PC mode to another resolution, change the refresh rate to another rate or adjust the brightness and contrast on the menu until the picture is clear. If the refresh rate of the PC graphic card cannot be changed, change the PC graphic card or consult the manufacturer of the PC graphic card.

NOTES:

- 1 Use a DVI cable.
- 2 Avoid keeping a fixed image on the TV's screen for a long period of time. The fixed image may become permanently imprinted on the screen.
- 3 The synchronization input form for Horizontal and Vertical frequencies is separate.

Resolution

Mode	Resolution	Frame frequency (Hz)
PC	640*480	60Hz
SPC	800*600	60Hz/75Hz
XGA	1024*768	60Hz
		75Hz

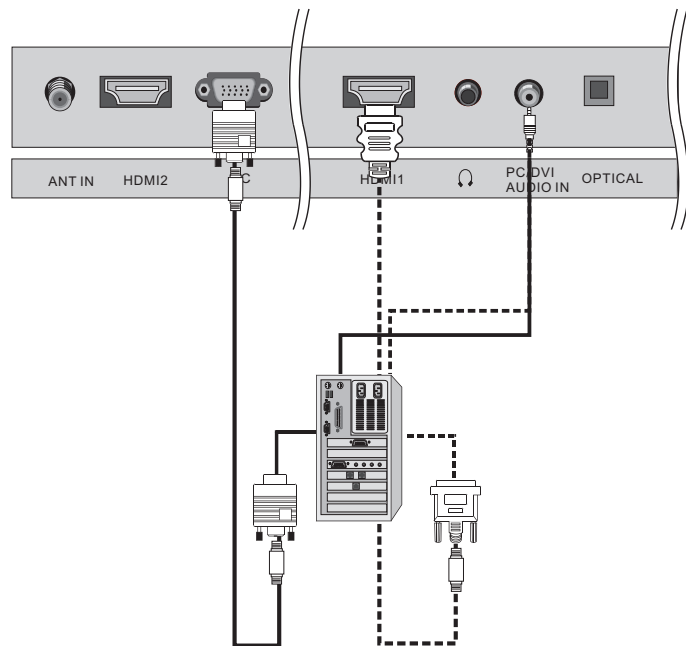

External Equipment Connections

Monitor Out Setup

The TV has a special signal output capability which allows you to hook up a second TV or monitor.

Connect the second TV or monitor to the TV's AV OUT. See the Operating Manual of the second TV or monitor for further details regarding that device's input settings.

Notes:

YPbPr, PC, HDMI, DTV input sources cannot be used for Monitor out.

When connecting with external audio equipments, such as amplifiers or speakers, please turn the TV speakers off.

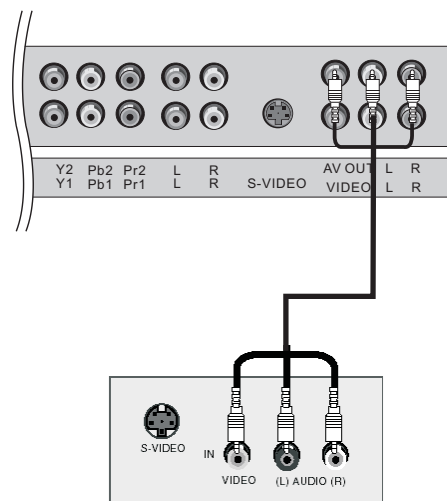

HDMI

<When the source device(DVD player or Set Top Box) supports HDMI>

How To Connect

1. Connect the source device to HDMI port of this TV with an HDMI cable(not supplied with this product).
2. No separated audio connection is necessary.

How To Use

- If the source device supports Auto HDMI function, the output resolution of the source device will be automatically set to 1280x720p.
 - If the source device does not support Auto HDMI, you need to set the output resolution appropriately.
- To get the best picture quality, adjust the output resolution of the source device to 1280x720p.
- Select HDMI input source in input source option of Select Main source menu.

<When the source device(DVD player or Set Top Box) supports DVI>

How To Connect

1. Connect the source device to HDMI port of this TV with a HDMI-to-DVI cable(not supplied with this product).
2. A separated audio connection is necessary.
3. If the source device has an analog audio output connector, connect the source device audio output to DVI Audio In port located on the left side of HDMI port.

How To Use

- If the source device supports Auto DVI function, the output resolution of the source device will be automatically set to 1280x720p.
 - If the source device does not support Auto DVI, you need to set the output resolution appropriately.
- To get the best picture quality, adjust the output resolution of the source device to 1280x720p.
- Press the INPUT button to select HDMI input source in input source option of Select Main source menu.

Cable sample



HDMI Cable
(not supplied with the product)

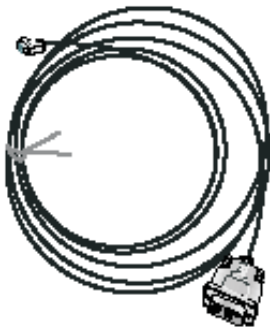

HDMI to DVI Cable
(not supplied with the product)



Analog Audio Cable
(Stereo to RCA type)
(not supplied with the product)

External Equipment Connections

Connecting Headphones

You can connect a set of headphones to your set if you wish to watch a TV programme without disturbing the other people in the room.

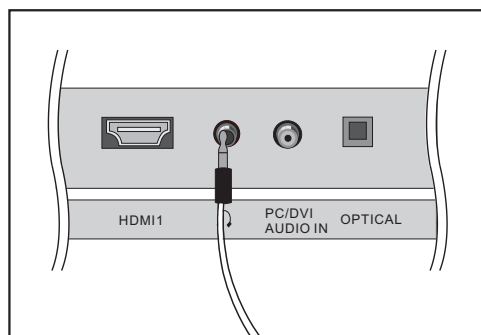

Plug a set of headphones into the 3.5mm mini-jack socket on the rear panel of the set.

Note:

- Prolonged use of headphones at a high volume may damage your hearing.
- You will not receive sound from the speakers when you connect headphones to the system.

Power source

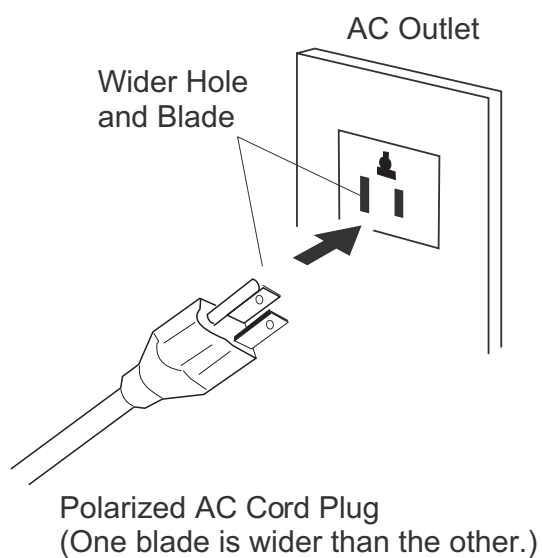

TO USE AC POWER SOURCE

Use the AC polarized line cord provided for operation on AC. Insert the AC cord plug into a standard polarized AC outlet.

NOTES:

- Never connect the AC line cord plug to other than the specified voltage. Use the attached power cord only.
- If the polarized AC cord does not fit into a non-polarized AC outlet, do not attempt to file or cut the blade. It is the user's responsibility to have an electrician replace the obsolete outlet.
- If you cause a static discharge when touching the unit and the unit fails to function, simply unplug the unit from the AC outlet and plug it back in. The unit should return to normal operation.

Operation

- In the manual, the OSD (on screen display) may be different from your TV's, because it is just an example to help you with the TV operation.
- There are several options you might need to set up in order for your TV to work properly. Read the instructions that follow.

Switching On/Off the TV set

1. First, connect power cord correctly, and then press **POWER** button on the remote control to turn on the TV.
2. Select the viewing source by using **INPUT** button on the remote control.
3. When finished using the TV, press the **POWER** button on the remote control. The TV reverts to standby mode.
4. If you intend to be away on vacation, disconnect the power plug from the wall power outlet.

Note:

If the TV in power on, the screen show information according the type of input signal. the information will disappear. If there is no signal and blue screen in ON the screen enter in bluescreen and display "No signal" on top and center of the screen.

Choose the Menu Language

When you start using your set for the first time, you must select the language which will be used for displaying menus and indications.

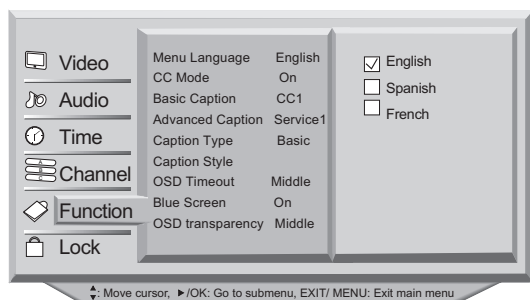

- 1 Press the **MENU** button and then use **▲/▼** button to select the **Function** menu.
- 2 Press the **▶** button and then use **▲/▼** button to select **Menu Language**.
- 3 Press the **▶** button and then use **▲/▼** button to enter the list of available language. (**English, Spanish or French**)
- 4 Select your language with the **▲/▼** button and press the **OK** button to confirm you selection.
- 5 When you are satisfied with your choice, press the **EXIT** button to return to normal viewing or press **MENU** button to return to the previous menu.

Choose the Input source

- Change the picture source so you can watch your TV, cable TV, VCR, DVD, or any other devices that are connected to your TV.

1. Press the **INPUT** button to enter the Select Main picture Source menu and then use **▲/▼** button to select the desired **items**. (Cable/Air TV, VIDEO1, VIDEO2, SVIDEO, COMPONENT1, COMPONENT2, PC, HDMI1, HDMI2, INNER DVD.)
2. Press the **OK** button to confirm.
3. Press **INPUT** button to return to TV viewing or press **EXIT** button to return to the previous menu.

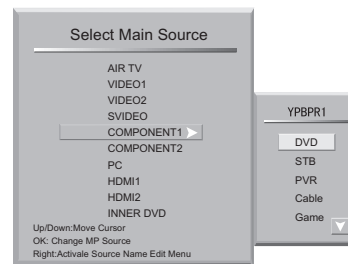

Note:

1. According to your connection device, you can change the name of every source.
2. In channel menu, if the Tuner item is setting as Air or Cable, the source menu will display Air TV or Cable TV;

Channel menu

- This TV set has three methods to set channels, which are respectively Auto Scan, manual Scan, fine tune.
- In this section, how to use the remote control to set channel is explained. You can also use buttons on the TV set to set channel.
- A password is required to gain access to Channel menu if the Lock of Edit program menu is turned on.

Automatic Scan

- Automatically finds all channels available through antenna or cable inputs, and stores them in memory on the All Channel List.

Note : Channel menu only available after selecting “Air TV or Cable TV” in the input menu.

- 1 Press the **MENU** button and then use **▲/▼** button to select the **Channel** menu.
- 2 Press the **▶** button and then use **▲/▼** button to select **Tuner**.
- 3 Press the **▶** button and then use **▲/▼** button to Select **Cable** or **Air** mode.
- 4 Press the **OK** button
- 5 When you are satisfied with your choice, press **MENU** button to return to the previous menu.
- 6 Press the **▲/▼** button to select **Auto Scan**.
- 7 Press the **▶** button and press the **OK** button to start searching.
- 8 To cancel searching, press the **OK** button.

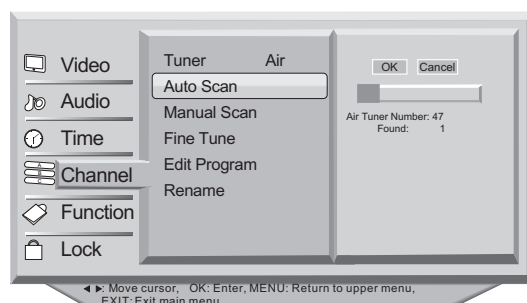
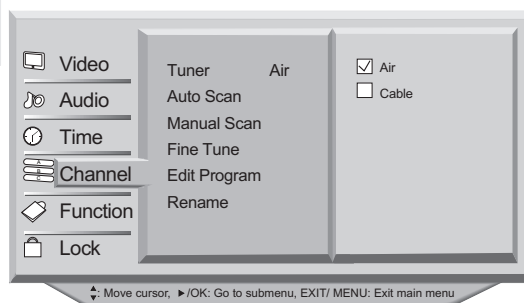

When **Air** is selected, the TV will detect antenna signals and will search for antenna TV (NTSC and ATSC) channels available in your local area.

When **Cable** is selected, the TV will detect cable company supplied signals and will search for cable TV (NTSC, ATSC, QAM modulated) channels available in your area.

Channel menu

Manual Scan

If excessive channel signals of unwanted programs are received in local area, manual search function is recommended.

- 1 Press the **MENU** button and then use **▲/▼** button to select the **Channel** menu.
- 2 Press the **▶** button and then use **▲/▼** button to select **Tuner**.
- 3 Press the **▶** button and then use **▲/▼** button to Select **Cable** or **Air** mode.
- 4 Press the **OK** button.
- 5 When you are satisfied with your choice, press **MENU** button to return to the previous menu.
- 6 Press the **▲/▼** button to select **Manual Scan**.
- 7 Press the **▶** button and then use digital buttons to select channel number you want to add or delete.
- 8 Press the **▼** button to select OK item and press **OK** button to add for the channel number.
- 9 Press **EXIT** button to return to TV viewing or press **MENU** button to return to the previous menu.

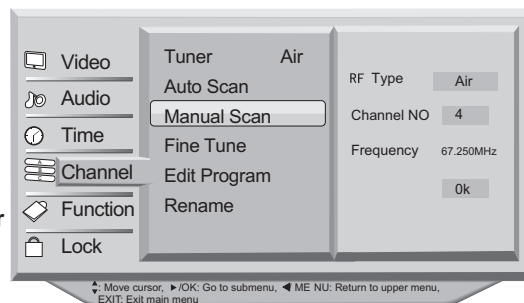

Fine Tune (only in analog signal)

- 1 Press the **MENU** button and then use **▲/▼** button to select the **Channel** menu.
- 2 Press the **▲/▼** button to select **Fine Tune**.
- 3 Press the **▶** or **OK** button
- 4 Press the **◀/▶** button to tune.
- 5 Press **EXIT** button to return to TV viewing or press **MENU** button to return to the previous menu.

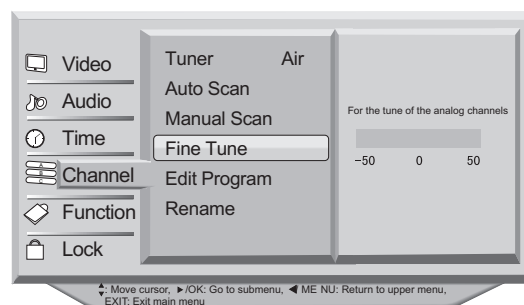

Channel menu

Edit Program

- You can create your own Favorite List. Use the “FAV.LiST” button on the remote control when a channel is highlighted and then you can add or delete the channel to/from the Favorite List.
- You can skip some channel;
- You can lock some channel;

1 Press the **MENU** button and then use ▲/▼ button to select the **Channel** menu.

2 Press the ► button and then use ▲/▼ button to select **Edit Program**.

3 Press the ► button. You will now see a screen filled with channel numbers.

4 Use ▲/▼/◀/▶ button to select FAV., Lock or Skip item, and then use the **OK** button to confirm.

5 When you are satisfied with your choice, press **MENU** button to return to the previous menu or Press **EXIT** button to return to TV viewing.

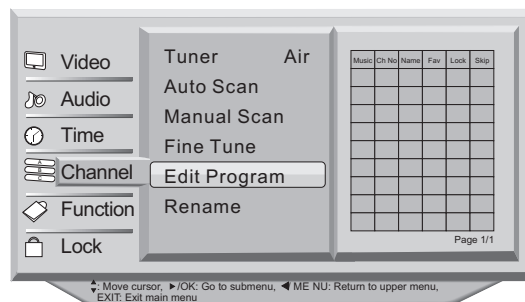

Skip

After the programs are presetting, you can skip some programs so that to select your favorite channels only.

Lock

After the programs are presetting, you can lock some programs so that to select your favorite channels only.

Fav (Favorite)

Press the “FAV.LiST” button open the favorite channel list, press ▲/▼ button to select the channel and press OK button to confirm.

Rename (only in analog signal)

1 Press the **MENU** button and then use ▲/▼ button to select the **Channel** menu.

2 Press the ► button and then use ▲/▼ button to select **Rename**.

3 Press the ► or **OK** button to enter the Submenu.

4 The cursor flashes, Use the digital button to select the letter, and press ◀/▶ button to move the cursor and **MENU** button to confirm. (Press the Q.VIEW button to delete the letter.)

5 When you are satisfied with your choice, press **MENU** button to return to the previous menu or Press **EXIT** button to return to TV viewing.

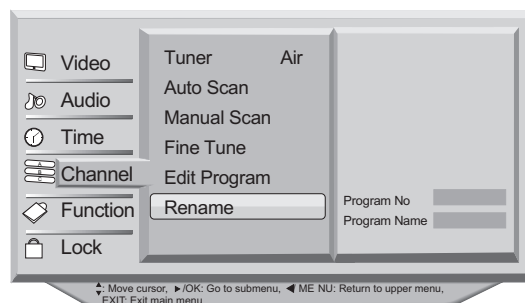

Select the desired program

1 Using the CH+/- buttons.

- Press the CH+ button to select a channel number in number increasing direction.
- Press the CH- button to select a channel number in number decreasing direction.

(Note: If Skip is ON on one channel, press CH+/- button, the channel will not appear.)

Select the desired sound

Press the VOL-/+ or ◀/▶ buttons on the remote or the front of the TV set to adjust the volume level. The range is 0~100. When the volume buttons are pressed the volume level is displayed automatically on the TV screen.

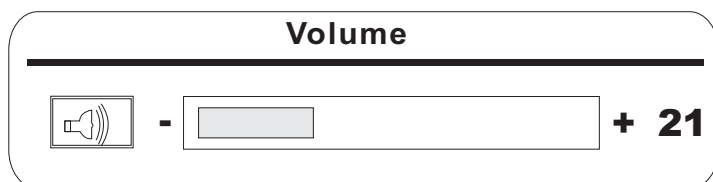

Mute

When you need to pay attention to surrounded sounds, or there is a telephone calling you or there are some guests visiting you, the sound elimination (mute) function is very convenient.

1 Press the MUTE button on the remote control and "MUTE" type face will display on the screen. At this time, the sound of the TV set is turned off.

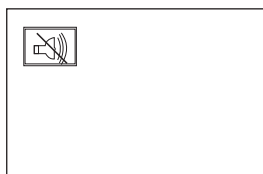

2 If you want to recover the sound, press the MUTE button again or directly press VOL+ button.

Video menu

The TV menu gives you an overview of the menus you can select.

Note: Depending on the input signal, one or more menu items may not be selectable.

How to select picture modes

The picture mode provides the pre-defined images settings. There are four settings: standard/vivid /mild/custom. Press P.MODE button repeatedly on the remote control to select the desired option(Standard/Vivid/Mild/Custom).

- **Standard:** normal mode.
- **Vivid:** mode of watching the movement of picture.
- **Mild:** the effect of the picture is soft.
- **Custom:** picture effect which you favorite.

How to customize your own picture status

- 1 Press the **MENU** button and then use **▲/▼** button to select the **Video** menu.
- 2 Press the **▶** button and then use **▲/▼** button to select the desired items.
- 3 Press the **▶** button and then use **▲/▼** button to adjust the setting.
- 4 When you are satisfied with your choice, press **MENU** button to return to the previous menu or press the **EXIT** button to return to TV viewing.

■ Contrast

This will adjust the intensity of bright parts in the picture but keep the dark parts unchanged.

■ Brightness

This will adjust the light output of the complete picture, which will mainly affect the darker areas of the picture.

■ Tint

Allows you to select the color mix (Tint) of the picture.

■ Color

This will adjust the saturation level of the colors to suit your personal preference.

■ Sharpness

This will adjust the sharpness of fine details in the picture.

■ DNR (Digital Noise Reduction)

Automatically filters out and reduces the image noise and improves picture quality when receiving weak video signals.

Select **Off/Weak/Medium/Strong** according to the image noise.

■ Color temperature

This will increase or decrease **Warm** (red) and **Cold** (blue) colors to suit personal preferences.

Select **Cold** to give the white colors a blue tint, **Standard** to give the white colors a neutral tint, **Warm** to give the white colors a red tint.

■ Black Stretch

This will increase automatically the contrast range.

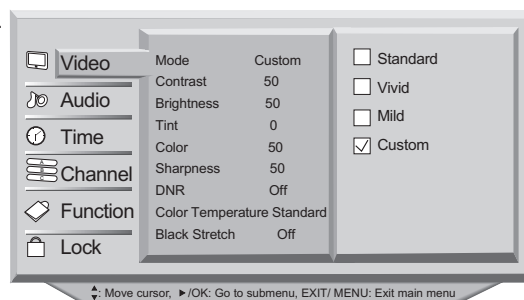

Note:

Only when the item of mode is custom, the Contrast, Brightness, Tint, color, Sharpness can be set by user. In other mode the value of them are preset by program.

Aspect Ratio Control

- Lets you choose the way an analog picture with a 4:3 aspect ratio is displayed on your TV with a 16:9 ratio picture format.

- **Note:** If a fixed image is displayed on the screen for a long time, it image may become imprinted on the screen and remain visible.

1 Press the **ARC** button the Aspect Ratio menu appearance on the screen.

2 Press the **▲/▼** button to select the desired picture format.

3 Press the **OK** button to confirm.

■ 4:3 mode

Choose **4:3** when you want to view a picture with an original 4:3 aspect ratio, with gray bars appearing at both the left and right sides.

■ 16:9 mode

Choose **16:9** when you want to adjust the picture horizontally, in a linear proportion to fill the entire screen.

■ Zoom 1

Choose **Zoom 1** when you want to view the picture without any alteration. However, the top and bottom portions of the picture will be cropped.

■ Zoom 2

Choose **Zoom 2** when you want the picture to be altered, both vertically extended and cropped. The picture taking a halfway trade off between alteration and screen coverage.

■ Subtitle

Choose **Subtitle** when you want to adjust the picture in a non-linear proportion, that is, more enlarged at top sides and no alteration, at bottom side.

■ PANORAMA

Choose **PANORAMA** when you want to enlarge the picture in correct proportion.

Note: When enlarging or reducing the picture size, the image may become distorted.

Notes

■ In TV, VIDEO1, VIDEO2, SVIDEO modes, all screen modes can be selected. (16:9 Mode . Panorama . Zoom1 . Zoom2 . 4:3 Mode. Subtitle).

■ In YPbPr, HDMI modes, only 16:9 Mode, 4:3 modes, Zoom1 or Zoom2 can be selected.

■ In PC mode, only 16:9 Mode, 4:3 mode, dot by dot can be selected.

■ In DTV mode, only 16:9 Mode, 4:3 mode can be selected.

Audio menu

How to Select Audio modes

Press S.MODE button repeatedly on the remote control to select the desired option (Live/POP/Rock/Custom).

- **Custom** A spare setting that can be adjusted to personal tastes.
- **Live** Normal sound with moderate bass and treble setting.
- **POP** Designed to reduce the bass and treble which enhances the voice for news programs.
- **Rock** Enables extra bass and treble to enhance the movie experience.

How to Customize your own audio status

- 1 Press the **MENU** button and then use **▲/▼** button to select the **Audio** menu.
- 2 Press the **▶** button and then use **▲/▼** button to select the desired items.
- 3 Press the **▶** button and then use **▲/▼** button to adjust the setting.
- 4 When you are satisfied with your choice, press **MENU** button to return to the previous menu or press the **EXIT** button to return to TV viewing.

■ Headphone volume

This controls the level of sound through the headphones.

■ Volume

This will adjust the sound output level.

■ Balance

This will adjust the output of the right and left speakers to obtain the best stereo reproduction for your listening position.

■ Equalizer Mode

This sound setting can be adjusted to suit your personal preference.

■ Digital Audio (only selectable with digital broadcast signals)

Make your selection of the source to which the device with digital audio input has been connected.

In addition to accepting audio input via Digital Audio In, the TV can output Digital audio via the **Optical** connector to an external amplifier or receiver. If your amplifier or receiver has a matching connector for Digital Audio In, you can connect it with a single cable to the TV's **Optical**.

■ AVL (Automatic volume control)

This will reduce the differences in volume level among broadcasters.

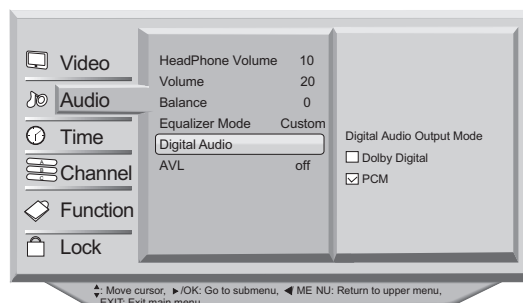
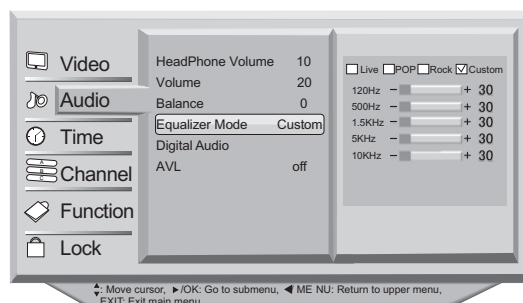
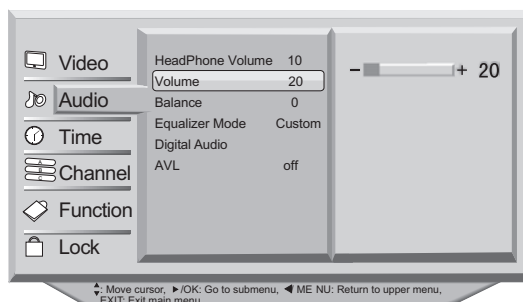

Audio menu

SAP Broadcasts Setup

- This TV can receive MTS stereo programs and SAP (Secondary Audio Program) that accompanies the stereo program; if the station transmits an additional sound signal as well as the original one.
- When having selected SAP button on the remote control, this TV can only receive the signal when the TV station transmits the proper signals.
- Mono sound is automatically received if the broadcast is only in Mono; even though Stereo or SAP has been selected.
- Select Mono if you want to listen to mono sound during stereo/SAP broadcasting.
- Stereo or SAP can be received in a Analog channel.

1. Use the **SAP** button to select your desired MTS mode in a analog signal. Each time you press the **SAP** button, **Mono**, **Stereo**, or **SAP** appear.

If other languages are available on the digital signal, select them with the **SAP** button.

2. Press **EXIT** button to save and return to TV viewing.

Time menu

Date /Time setting

Setting the clock is necessary in order to use the various timer features of the TV. Also, you can check the time while watching the TV.

- 1 Press the **MENU** button and then use **▲/▼** button to select the **Time** menu.
- 2 Press the **▶** button and then use **▲/▼** button to select the **Date/Time**.
- 3 Press the **▶** button and then use **◀/▶** button to select the Mode: **Manual** or **Auto**.
- 4 When you are satisfied with your choice, press **MENU** button to return to the previous menu or press the **EXIT** button to return to TV viewing.

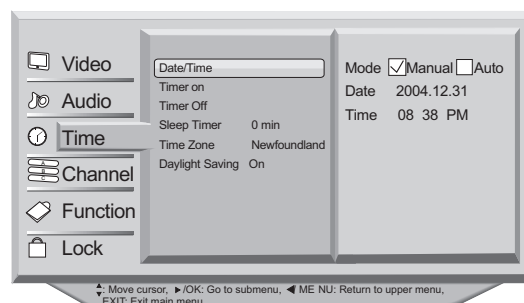

Timer on setting

Switch on automatically at the time you presetting.

- 1 Press the **MENU** button and then use **▲/▼** button to select the **Time** menu.
- 2 Press the **▶** button and then use **▲/▼** button to select the **Timer On**.
- 3 Press the **▶** button and then use **◀/▶** button to select the Mode: **Off**, **Once** or **Daily**.
- 4 Press the **OK** button to confirm.
When selecting **Once** or **Daily** item, **On time** item will be active, press **▲/▼** button to set the desired level, press **◀/▶** button to button move cursor.
- 5 When you are satisfied with your choice, press **MENU** button to return to the previous menu or press the **EXIT** button to return to TV viewing.

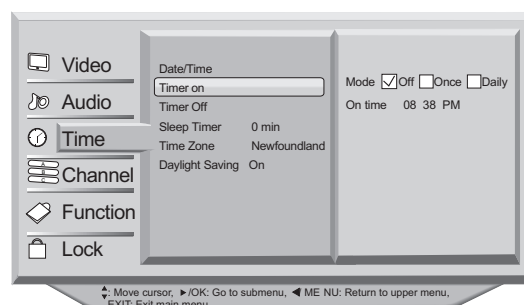

Timer off setting

Switch off automatically at the time you presetting.

- 1 Press the **MENU** button and then use **▲/▼** button to select the **Time** menu.
- 2 Press the **▶** button and then use **▲/▼** button to select the **Timer Off**.
- 3 Press the **▶** button and then use **◀/▶** button to select the Mode: **Off**, **Once** or **Daily**.
- 4 Press the **OK** button to confirm.
When selecting **Once** or **Daily** item, **On time** item will be active, press **▲/▼** button to set the desired level, press **◀/▶** button to button move cursor.
- 5 When you are satisfied with your choice, press **MENU** button to return to the previous menu or press the **EXIT** button to return to TV viewing.

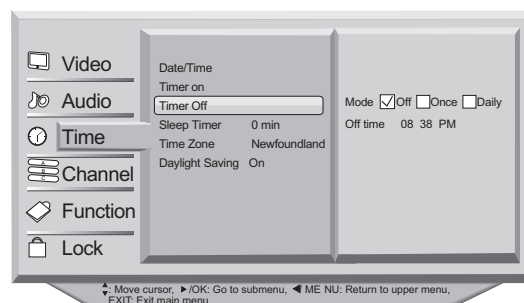

Time menu

Sleep Timer setting

The sleep timer automatically shuts off the TV after a preset time (from 15 to 120 minutes).

- 1 Press the **MENU** button and then use **▲/▼** button to select the **Time** menu.
- 2 Press the **▶** button and then use **▲/▼** button to select the **Sleep Timer**.
- 3 Press the **▶** button and then use **▲/▼** button to select the number of minutes. Select **0Min, 15Min, 30Min, 60Min, 90Min, 120Min**.

When the number of minutes you want is displayed on the screen, press the **OK** button. The time begins to count down from the number of minutes selected.

- 4 When you are satisfied with your choice, press **MENU** button to return to the previous menu or press the **EXIT** button to return to TV viewing.

- 5 To cancel the set sleep timer:

Press the **▲/▼** button to select **0min**.

You can use the **SLEEP** button also to select quickly the sleep timer.

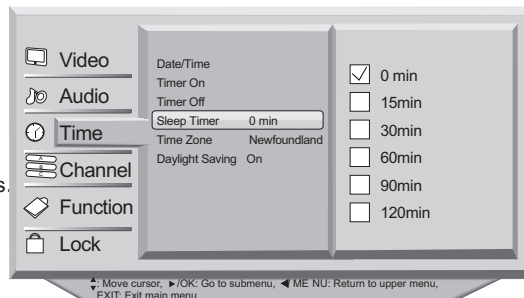

Time zone setting

*(only available when date/time mode is set to Automatic)
This function allows you to select your local time zone.
Broadcasted time information will correct the clock display for your local time.*

- 1 Press the **MENU** button and then use **▲/▼** button to select the **Time** menu.
- 2 Press the **▶** button and then use **▲/▼** button to select the **Time Zone** items.
- 3 Press the **▶** button and then use **▲/▼** button to adjust the setting.
- 4 When you are satisfied with your choice, press **MENU** button to return to the previous menu or press the **EXIT** button to return to TV viewing.

Press the **▶** button and then use **▲/▼** button to select your viewing area time zone: **Newfoundland, Atlantic, Eastern, Central, Mountain, Pacific, Alaska, Hawaii** or **Samoa**.

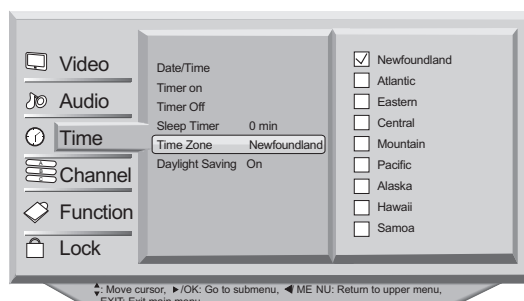

Daylight Saving setting

*(only available when date/time mode is set to Automatic)
Daylight saving time is automatically set by specially broadcasted signals.
This menu item allows you to disable the automatic setting of daylight saving time. This is useful if you live in an area or state where daylight saving is not applied, but you receive channels from other areas where daylight saving signals are broadcasted.*

- 1, Press **▲/▼** button to select **Daylight Saving** item.
2. Press the **▶** button to select **On** for automatic clock correction for daylight saving time, based on specially broadcasted signals. Select **Off** to disable automatic clock correction based on the specially broadcasted signals.

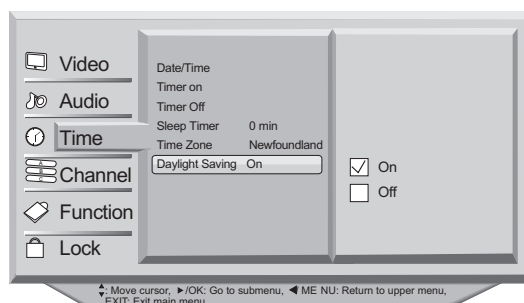

Function menu

Closed Captions

Closed captioning is a process which converts the audio portion of a television program into written words which then appear as subtitles on the television screen. Closed captions allow viewers to read the dialogue and narration of television programs.

Using Closed Captions

Captions are the subtitles of the dialogue and narration of television programs. For prerecorded programs, program dialogue can be arranged into captions in advance. It's possible to caption a live program by using a process called real-time captioning, which creates captions instantly. Real-time captioning is normally done by professional reporters using a machine shorthand system and computer for translation into English. Captioning is an effective system for the hearing-impaired, and it can also aid in teaching language skills.

CC mode

1. Press the **MENU** button and then use **▲/▼** button to select the **Function** menu.
2. Press the **▲/▼** button to select the **CC mode**.
3. Press the **▶** button and then use **▲/▼** button to select the items: (**On**, **Off** or **On When mute**.)
4. When you are satisfied with your choice, press **MENU** button to return to the previous menu or press the **EXIT** button to return to TV viewing.

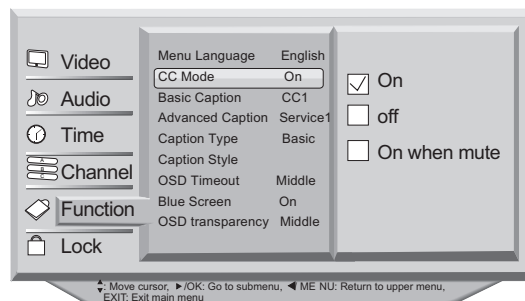

Note: The captions do not always use correct spelling and grammar. Not all TV programs and product commercials are made for broadcast with Closed Caption information included. Refer to your area's TV program listings for the TV channels and times of Closed Caption shows. The captioned programs are usually noted in the TV listings with service marks such as "CC".

Basic Caption

This allows you to configure the way you choose to view the digital captioning.

1. Press the **MENU** button and then use **▲/▼** button to select the **Function** menu.
2. Press the **▶** button and then use **▲/▼** button to select Basic Caption.
3. Press the **▶** button and then use **▲/▼** button to select caption: **CC1**, **CC2**, **CC3**, **CC4**, **Text1**, **Text2**, **Text3**, or **Text4**.
4. When you are satisfied with your choice, press **MENU** button to return to the previous menu or press the **EXIT** button to return to TV viewing.

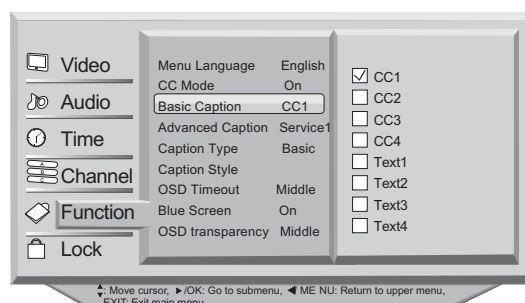

■ CAPTION

The term for the words that scroll across the bottom of the TV screen; usually the audio portion of the program provided for the hearing impaired.

■ TEXT

The term for the words that appear in a large black frame and almost cover the entire screen; usually messages provided by the broadcaster.

Advanced Caption (In DTV mode)

This allows you to configure the way you choose to view the digital captioning.

Select one of the digital service channels made available by the caption provider.

There are 6 standard services. Service 1 is designated as the Primary Caption Service. This service contains the verbatim, or near-verbatim captions for the primary language being spoken in the accompanying program audio.

Service 2 is designated as the Secondary Language Service. This service contains captions in a secondary language which are translations of the captions in the primary Caption Service. The other service subchannels are not pre-assigned. It is up to the discretion of the individual caption provider to utilize the remaining service channels.

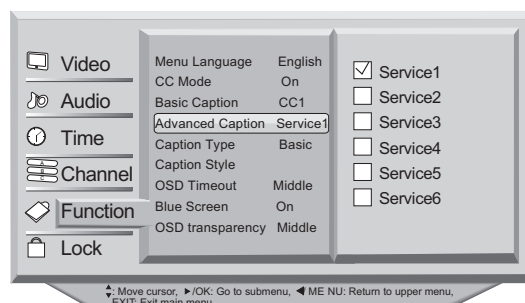

Caption Style (In DTV mode)

This allows you to modify how digital captions are displayed on your TV. Select from the following options to change the visual characteristics of your TV's digital captioning.

1. Press the **MENU** button and then use **▲/▼** button to select the **Function** menu.
2. Press the **▶** button and then use **▲/▼** button to select **Caption Style**.
3. Press the **▶** button and then use **◀/▶** button to set style as **Custom**.
4. Use **▲/▼** button to customize the Style, Font, etc., to your preference.
5. When you are satisfied with your choice, press **MENU** button to return to the previous menu or press the **EXIT** button to return to TV viewing.

■ Style

Select this option to select the font style of caption display according to your own preference.

Press the **▲/▼** button to select **Default, Custom, Style1, Style2, Style3, Style4, Style5, Style6, Style7, Style8**.

Press the **OK** button to confirm.

■ Size

Select this option to select the size of caption display according to your own preference.

Press the **▲/▼** button to select **Default, Small, Normal** or **Large**,

Press the **OK** button to confirm.

■ Font

Select this option to select the font of caption display according to your own preference.

Press the **▲/▼** button to select **Default, Font1, Font2, Font3, Font4, Font5, Font6, Font7**.

Press the **OK** button to confirm.

■ Text color

Select this option to select the text color or the opacity of the text box of caption display according to your own preference.

Select a color and one of the opacity options.

■ **Text Opacity**: Specify the opacity for the text color.

■ **BG (Background) Color**: Select a background color.

■ **BG (Background) Opacity**: Select the opacity for the background color.

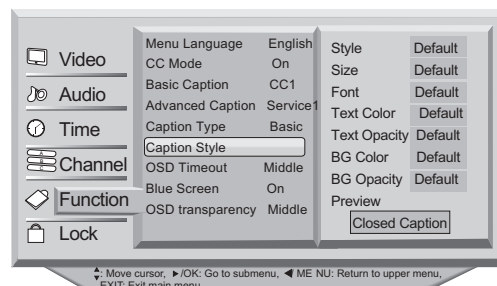

OSD Timeout

1. Press the **MENU** button and then use **▲/▼** button to select the **Function** menu.
2. Press the **▶** button and then use **▲/▼** button to select **OSD Timeout**.
3. Press the **▶** button and then use **▲/▼** button to select **short, middle** or **Long**.
4. Press the **OK** button to confirm.

Blue screen

Select this option to select the character background color.

1. Press the **MENU** button and then use **▲/▼** button to select the **Function** menu.
2. Press the **▶** button and then use **▲/▼** button to select **Blue screen**.
3. Press the **▶** button and then use **▲/▼** button to select **on** or **off**.
4. Press the **OK** button to confirm.

OSD transparency

1. Press the **MENU** button and then use **▲/▼** button to select the **Function** menu.
2. Press the **▶** button and then use **▲/▼** button to select **OSD transparency**.
3. Press the **▶** button and then use **▲/▼** button to select **Low**, **middle** or **High**.
4. Press the **OK** button to confirm.

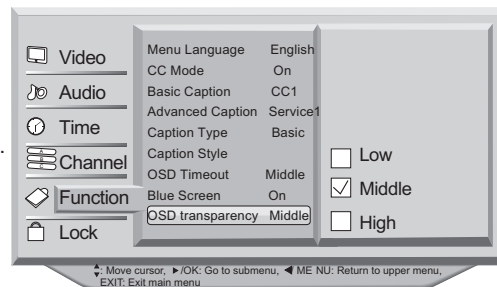
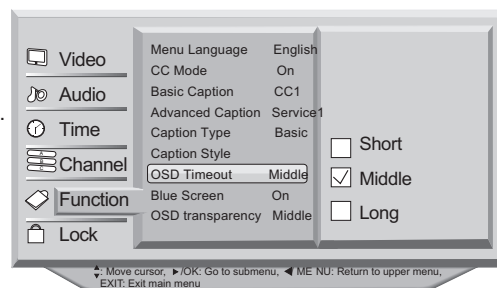

Adjust menu

Screen Setup for PC mode

- When RGB connect to PC input and select the PC, this function is used.

Adjustment for screen Position, Size, Phase, Reset

- Display PC Adjust Menu by pressing **INPUT** button then use **▲/▼** button to select the PC item.

- Position : Adjust the screen position.
- Size : Adjust the screen size.
- Phase : Adjust the phase of Pixel clock.
- Mode : there are two modes: Auto Sync and default

- 1 Press the **MENU** button and then use **▲/▼** button to select the **Adjust** menu.
- 2 Press the **▶** button and then use **▲/▼** button to select the desired items.
- 3 Press the **▶** button and then use **◀/▶** button to adjust the setting.
- 4 When you are satisfied with your choice, press **MENU** button to return to the previous menu or press the **EXIT** button to return to TV viewing.

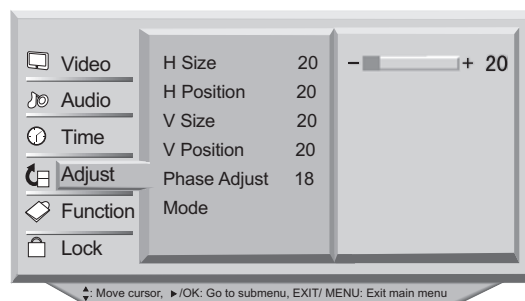

Lock Menu

Parental Control can be used to block specific channels, ratings and other viewing sources.

The Parental Control Function is used to block program viewing based on the ratings sent by the broadcasting station.

The default setting is to allow all programs to be viewed. Viewing can be blocked by choosing the type of the program and the categories.

It is also possible to block all program viewing for a time period. To use this function, the following must be done :

1. Set ratings and categories to be blocked.
2. Specify a password
3. Enable the lock

Parental Control rating and categories

Rating guidelines are provided by broadcasting stations. Most television programs and television movies can be blocked by TV Rating and/or Individual Categories. Movies that have been shown at the theaters or direct-to-video movies use the Movie Rating System (MPAA) only.

Ratings for Movies previously shown in theaters:

Movie Ratings :

- NR (Permits all programs)
- G (General audience)
- PG (Parental guidance suggested)
- PG-13 (Parents strongly cautioned)
- R (Restricted)
- NC-17 (No one 17 and under admitted)
- X (Adult only)

If you set PG-13 : G and PG movies will be available , PG-13, R, NC-17 and X will be blocked.

Ratings for Television programs including made-for-TV movies :

- TV-Y (All children)
- TV-Y7 (Children 7 years older)
- TV-G (General audience)
- TV-PG (Parental guidance suggested)
- TV-14 (Parents strongly cautioned)
- TV-MA (Mature audience only)

TV Rating Children:

- ALL (Age) (applies to TV-Y, TV-Y7)
- FV (Fantasy Violence) (applies to TV-Y7)

TV Rating General:

- ALL (Age) (applies to TV-G, TV-PG, TV-14, TV-MA)
- D (Dialogue - sexual dialogue) (applies to TV-PG, TV-14)
- L (Language - adult language) (applies to TV-PG, TV-14, TV-MA)
- S (Sex - sexual situations) (applies to TV-PG, TV-14, TV-MA)
- V (Violence) (applies to TV-PG, TV-14, TV-MA)

Lock setup

- Set up blocking schemes to block specific channels, ratings, and external viewing sources.
- A password is required to gain access to this menu.

1. Press the **MENU** button and then use **▲/▼** button to select the **LOCK** menu. Then, press the **▶** button.

■ The TV is set up with the initial password “0-0-0-0” and security default password is 9-4-4-3.

2. Use the **▲/▼** button to choose from the right Lock Menu options. Once the option is selected, change the settings to your preference.

■ **Password:** Change the password by inputting a new password twice.

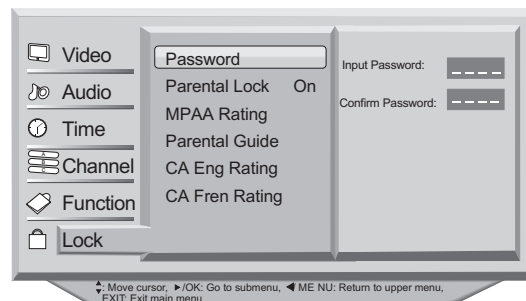

■ Parental Lock:

1. Press **▲/▼** button to select **Parental Lock** item.
2. Press the **▶** button to select **On** or **Off**.
3. Press the **OK** button to confirm.

Note:

if the Parental Lock is setting as Off, the change of the MPAA Rating, Parental Guide, CA Eng Rating and CA Fren Rating will be no useful.

■ **Movie Rating (MPAA):** Blocks movies according to the movie ratings limits specified, so children cannot view certain movies. You can set the ratings limit by blocking out all the movies with the ratings above a specified level. Keep in mind that the movie ratings limit only applies to movies shown on TV, not TV programs, such as soap operas.

- 1 Press **▲/▼** button to select **MPAA Rating** item.
- 2 Press the **▶** button and then use **▲/▼** button to select the rating.
- 3 Press the **OK** button to set block or unblock.
- 4 When you are satisfied with your choice, press **MENU** button to return to the previous menu or press the **EXIT** button to return to TV viewing.

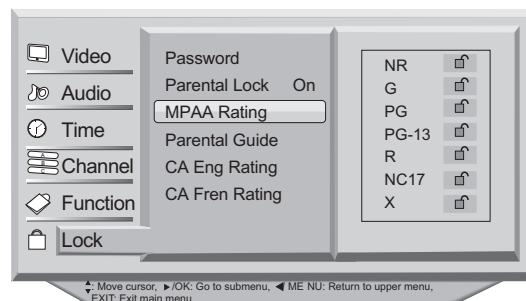

Lock setup

Parental Guide

■ **Parental Guide:** Blocks any channels that you do not want to watch or that you do not want your children to watch.

Note : The Parental control will automatically block certain categories that are “more restrictive” . For example, if you block “TV-Y” category, then TV-Y7 will automatically be blocked. Similarly, if you block the TV-G category, then all the categories in the “young adult” group will be blocked (TV-Y, TV-Y7, TV-G, TV-PG, TV-14, and TV-MA). The sub-ratings (D, L, S, V) work together similarly.

How to set the FV, D, L, S and V sub-ratings.

First, the ▲/▼ button select one of these Ratings: TV-Y, TV-Y7, TV-G, TV-PG, TV-14, or TV-MA, and press the ◀/▶ button. A symbol “🔒” will be displayed for each sub-rating.

While “🔒” is selected, press the **OK** button to go to a subrating.

To select a different Rating, press the ▲/▼ buttons and then repeat the process.

Note: The V-chip will automatically block certain categories that are “More restrictive” .For example, if you block “🔒” sub-rating in TV-PG, then the “🔒” sub-ratings in TV-14 and TV-MA will automatically be blocked.

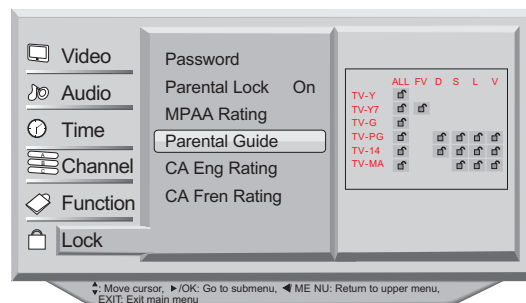

CA Eng Rating

Canadian English Language Rating

- 1 Press ▲/▼ button to select **CA Eng Rating** item.
- 2 Press the ▶ button and then use ▲/▼ button to select the rating.
- 3 Press the ok button to confirm.
- 4 When you are satisfied with your choice, press **MENU** button to return to the previous menu or press the **EXIT** button to return to TV viewing.

■ C	Children
■ C8+	Children eight years and older
■ G	General Programming, suitable for all audiences
■ PG	Parental Guidance
■ 14+	Viewers 14 years and older
■ 18+	Adult Programming

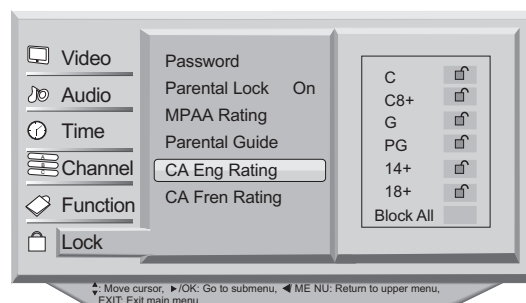

CA Fren Rating

Canadian French Language Rating

- 1 Press ▲/▼ button to select **CA Fren Rating** item.
- 2 Press the ▶ button and then use ▲/▼ button to select the rating.
- 3 Press the ok button to confirm.
- 4 When you are satisfied with your choice, press **MENU** button to return to the previous menu or press the **EXIT** button to return to TV viewing.

■ G	General
■ 8 ans+	8+ General - Not recommended for young children
■ 13 ans+	Programming may not be suitable for children under the age of 13
■ 16 ans+	Programming is not suitable for children under the age of 16
■ 18 ans+	Programming restricted to adults

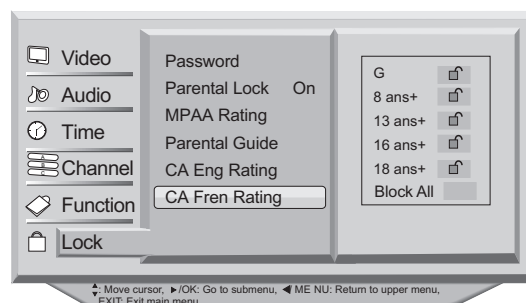

Brief Info.

- Brief Info shows the presentscreen information.
- Press the **INFO** button to show the Brief Info on the screen.
- Press the **INFO** button or **EXIT** button to exit.

Function:

- Show the presentscreen information.
- Press the **INFO** button or **EXIT** button to exit.

- A: Program title
- B: Program rating categories
- C: Video resolution
- D: Program name
- E: Additional information.
- F: Program signal intensity
- G: Present time, Day of week, Month



Quick program view

This function enables quick swap to the last watched program.

1 Suppose the channel number you used just now is 8 and the channel number you are using is 18 (as shown in the figure).

2 If you want to return to the last watched program channel 8, you can simply press the Q.View button.

3 If you want to return to channel 18, press the button again. Use this function, you can easily change between the channel you are using and the channel you used last time.

18

8

18

USB System

USB and Card Reader play prepare

1. Supporting equipment

1. Equipment supporting Mass and Storage agreements include USB, mobile hard disk, card reader, some MP3 and digital camera.

2. Equipment supporting PTP agreement includes some digital camera.

2.1 Supporting media:

picture, music, MPEG4, MPEG2 and MPEG1;

Supporting file format:

*.Avi, *.DIVX, *.MPEG, *.DAT, *.MP3, *.WMA, *.JPG and *.JPEG. Due to particularity of file code and file mode, It is possible that some files cannot be read.

2 If Pic & Music mode is activated, relative media file format will include JPEG and MP3 files. After Picture is selected, MP3 files set for play will open both music and picture files for sync play performance. As some files must be read while music is being played, the speed of picture operation response might be affected.

3. Before starting operation, verify USB storage device is of FAT32 and FAT file system format. At present, this television does not support NTFS and the file systems of other format.

4. Many movie files use suffix of AVI and MPG. However, many kinds of format

are used for internal files. This television can only play some AVI and MPG files of this format. Those files with suffix of data are not movie files, but data files used by computers, and cannot be played for movies.

5. External card reader supports most digital cards available in the market. Readable digital cards are classified according to the property of card readers and can be connected to mobile hard disks (working voltage 5.0V, working current not over 500mA).

6. Some Time the television operation may be halted due to excessive rate of information code errors. In such case, restart the system. As there are many nonstandard USB mobile devices in the market. If this kind of USB mobile devices are used in the stream media play system, the problem of identification failure might occur. The same problem may also happen with computers, not televisions.

7. It is suggested that the external devices with USB2.0 interface be used to improve velocity of information reading and continuity of information play.

USB System

USB and Card Reader setup

Note: Memory cards or USB devices are not supplied with this TV.

USB setup

- 1 Insert USB in the card slots at the right side of TV.
- 2 Insert it to be clicked in.
- 3 Press USB button on the remote controller to enter the stream media system.

CARD setup

This TV is Compatible with the card of SD/MMC/CF/MS format.

How to use

1、 Jack of card Instructions:

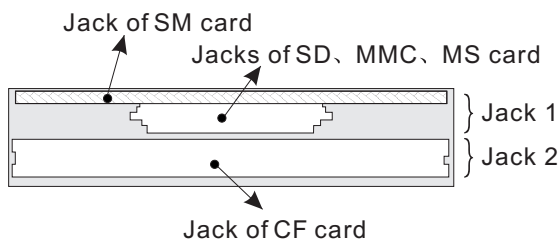

Note

1. Please note chooses uses the digital memory card with you corresponds the receptacle
2. Card reader in 1 cannot simultaneously insert two kind of cards in the graphical representation position

2、 Insert the card as right direction. As following Card in common use

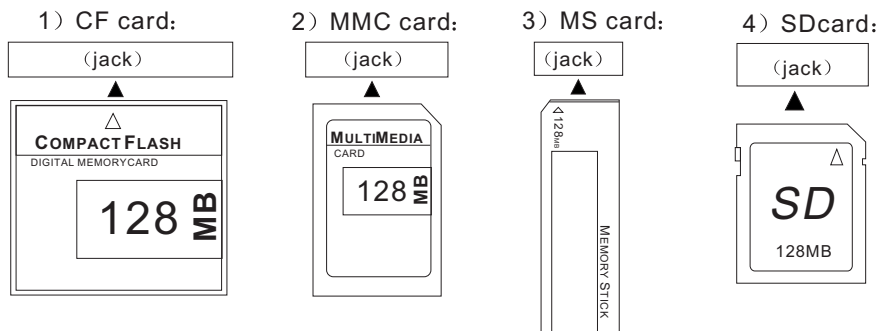

Note:

1. the card insertion time, after the flows media system starts 2s , insert the card to numerical code card reader , do not bring card to start flow media system.
2. After card insertion, indicator light will shines, and enters glitters condition, after period of time , indicator light enters constant bright condition, indicates already distinguishes finished, this time carries on play operation and so on .
3. In the market ,the digital card type are very many, please uses standard product of the standard factory , meets reads takes difficult or reads speed limits, please replaces the digital card.

USB System

Card data protection

- Do not remove the card/USB device when the content is being read or when browsing. Such action may damage the memory card/USB device.
- Do not touch the terminals on the back of the card.
- Always insert a card in the correct direction. Failure to do so may result in damage to the card and the unit.
- Do not subject the card to excessive pressure or strong impacts.
- Malfunctions of the unit or card may result in data loss or damage to the card.
- Haier shall not accept any liability for damage or loss of stored data.



Warning:

Memory cards can be swallowed by young children. Do not allow children to handle memory cards. Please remove the memory card immediately after use.

USB System



To start the media play

- 1 Press the USB button on the remote to enter USB system.
- 2 The system start up about 2 seconds, and then insert USB in the card slots
- 3 Press ▲/▼ to select the desired item, and press OK button to ensure it.
- 4 If to cancel the USB system, press EXIT button to return to the main menu, and then press TV button to select TV source.

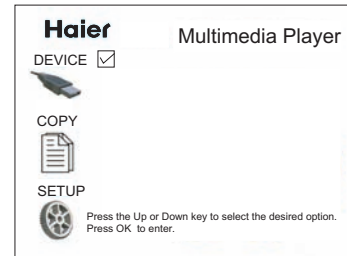

Note: If there are no operation two minute later, the TV will enter the saver automatically, at the time, press any button of USB system(with the exception of USB button) to exit the saver menu.

To operate the menu

1. Press ▲/▼ to select the item with up or down.
2. Press ◀/▶ to select the desired item of submenu with left or right.
3. Press OK button to ensure the desired option, to enter the submenu, to resume the speed of standard.
4. Press ▶▶ or ◀◀ button to operate play quickly or slowly.
5. Press || button to make the program stop, and press again to resume it.
6. Press ZOOM button to make zoom, and press ▲/▼ button to enjoy the detail.
7. Press HOTKEY button to call up or exit the OSD information. And press HOTKEY button to call up or exit the OSD during operating file copy.
8. Press RETURN button to return to previous menu and stop play, press RETURN button repeatedly to return to main menu.

USB System



Note:

1. the play file menu are different with your USB devices.
2. May carry on the programming playing: repeated step 2 to choose many documents, (right key choice or cancellation picture choice), press OK to play, at this time, the picture of play will be the picture be choosed.

To select broadcast system

1. Press ▲/▼ button to select DEVICE item.
(The device be inserted and identified).
2. Press OK button to enter adjusted option.

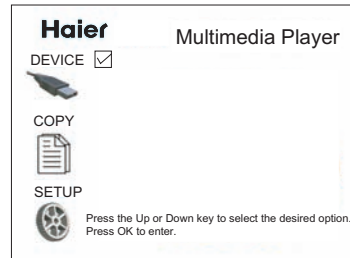

To play picture

- 1 Press ▲/▼ button to select Picture item.
- 2 Press OK button to enter the menu of play.
- 3 Press ▲/▼ button to select desired enjoy picture, and then press OK button to enter the play interface.

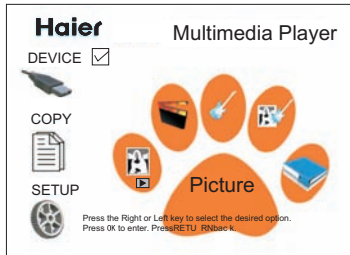

Note: you may play the pictures among selected.

- 4 During playing picture, Press HOTKEY button to call up picture menu, at this time, you can operate the picture of playing.

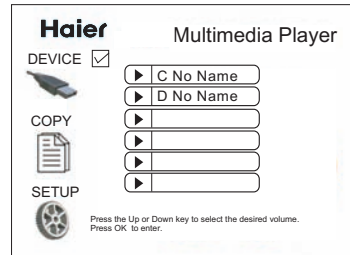

- 5 Press ◀/▶ button to select the adjusted item, Press OK button to confirm.

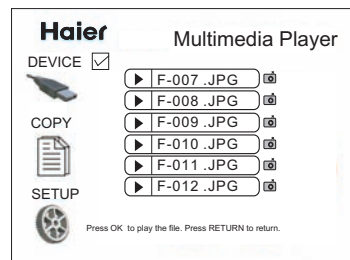

- ▶||: play or pause;
- : stop;
- : overturn;press ○ button to right turns over 90 not available;
- ⊞: 12 pictures scan; not available;
- ⏮: play previous picture;
- ⏭: play next picture;

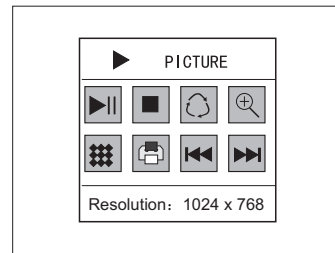

- 6 Press RETURN button to exit.

Note: The analysis rate basis picture itself clarity different and is different.

USBSystem



To play Movie

1 Press ◀/▶ button to select **Movie** option.

2 Press OK to enter playing menu.

3 Press ▲/▼ button to select desired movie, and press again OK to enter the playing movie interface.

4 During playing movie, Press HOTKEY button to call up picture menu, at this time, you can operate the movie of playing.

5 Press ◀/▶ button to select the adjusted item, Press Ok button to confirm.

- ▶||: play or pause;
- : stop;
- 🔊: not available;
- 🔍: zoom
- ▶▶: quickly
- ◀◀: slowly
- ◀◀◀: play previous movie;
- ▶▶▶: play next movie;

Captions: According to movie document itself whether has the captions to decide
 Audio channel: Mono, Stereo, Left, Right
 Play Mode: Standard, Repeat All, Repeat File

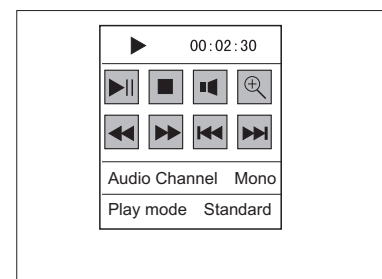
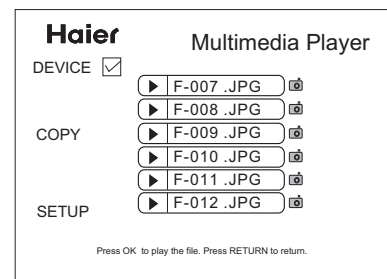
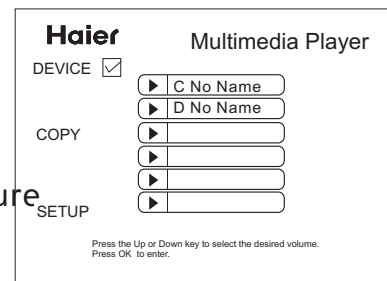
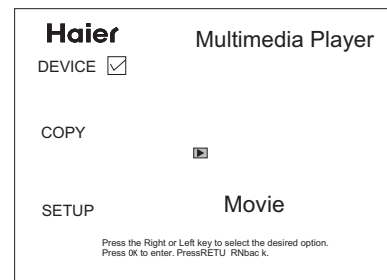

6 Press RETURN button to exit.

USB System



To enjoy music

- 1 Press ◀/▶ button to select **Music** option.
- 2 Press OK button to enter play menu.
- 3 Press ▲/▼ button to select the desired music, and then press OK button to the playing music interface.

Note: the play file menu are different with your USB device.

- 4 When playing music, Press ◀/▶ button to select the adjusted item, Press OK button to confirm.

- ▶||: play or pause;
- : stop;
- 🔊: Not available
- ▼: Not available
- ▶▶: Quickly
- ◀◀: Slowly
- ◀◀: play previous music;
- ▶▶: play next music;

Play Mode: Standard, Repeat File, Repeat All

- 5 Press RETURN button to exit the playing.

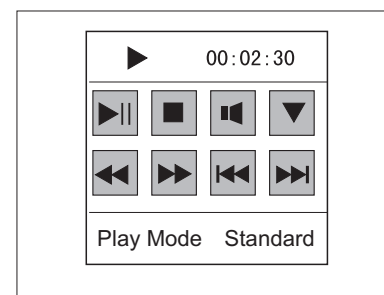
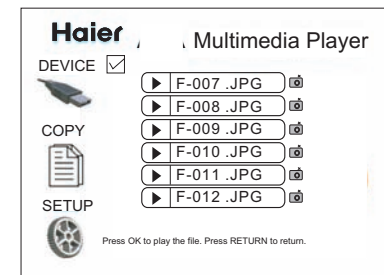
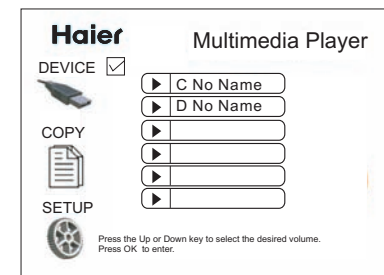
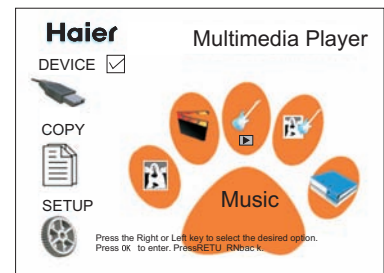

USBSystem



To select the Music and PIC combo

1 Press ◀/▶ button to select **Music and Pic** option, and press ENTER button to enter play menu.

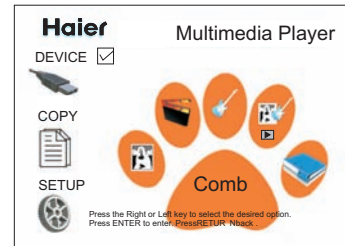

2 Press ▲/▼ to select desired file (picture and music), and press ENTER button to enter play menu.

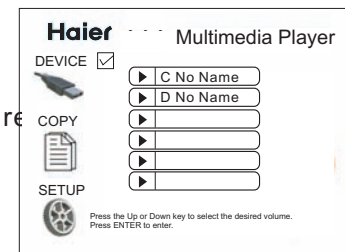

3 During playing music, Press **HOTKEY** button to call up picture menu, at this time, you can operate the movie of playing.

4 Press ◀/▶ button to select the adjusted item, Press OK button to confirm.

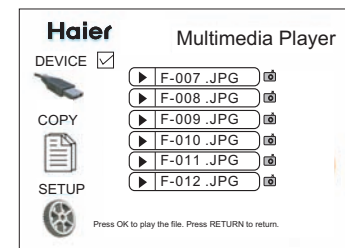

- ▶||: play or pause;
- : stop;
- 🔊: Not available
- 🔊: Not available
- ▶▶: Not available
- ◀◀: Not available
- ◀◀: play previous music;
- ▶▶: play next music;

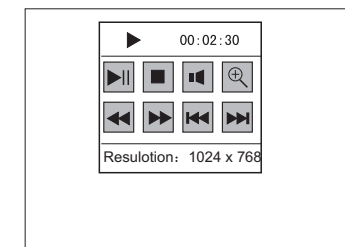

5 Press repeatedly RETURN button to return.

Note: Under music and picture condition, because the system reads the time of picture more longer than reads the time of music, therefore in the broadcast process, the picture appears the time lag to the music, this belongs to the normal phenomenon.

USB System



To select text

1 Press ◀/▶ button to select **text** option, and press OK button to enter text menu.

2 Press ▲/▼ to select desired text, and press OK button to confirm.

3 Press ▲/▼ button to watch the text.

4 Press repeatedly RETURN button to return.

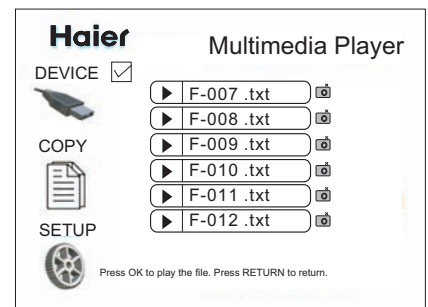
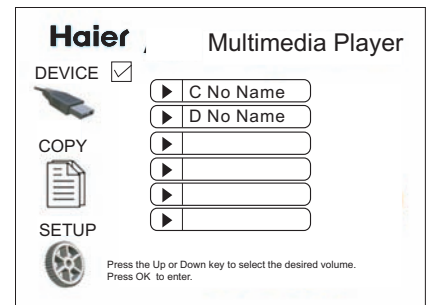

USB System



Copy file function

- 1 Press ◀/▶ to select **Copy** item.
- 2 Press OK button to enter the copy menu.
- 3 Press ▲/▼ button to select the desired item of copy.
- 4 Press HOTKEY button to call up Copy, Paste and delete, and then press ▲/▼ button to select Copy, and press OK button to confirm.
- 5 To select a folder, then Press OK button to enter, and then press HOTKEY button to call up Paste item, Press OK button to confirm.
- 6 If there are the same texts between the texts of paste, the “File already exist! Do you want Overwrite it?” will display on the screen, at this time, press ▲/▼ button to select the desired item, Press OK button to confirm.
7. Press OK to cancel.

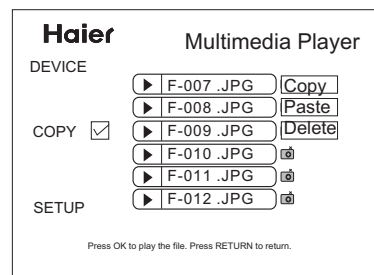
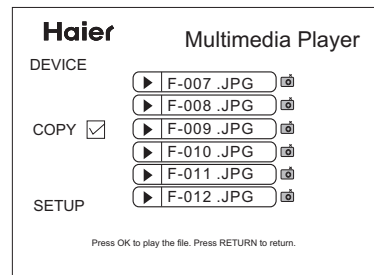
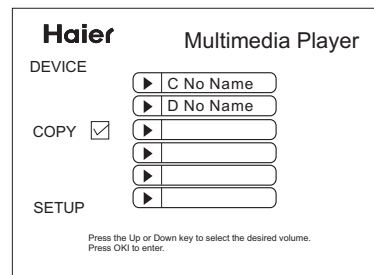
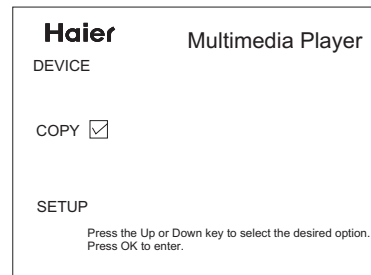

USBSystem



To select language

1 Press ▲/▼ to select SETUP item.

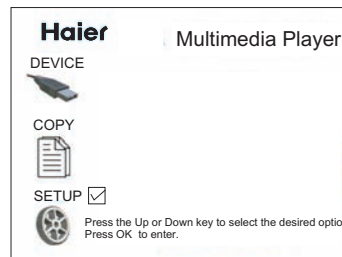

2 Press OK button to enter SETUP menu.

3 Press ▲/▼ to select **language** option, and then press OK button to enter the submenu.

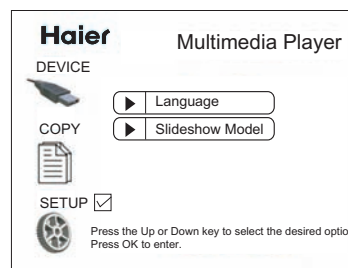

4 Press ▲/▼ to select desired language, and press OK to ensure it.

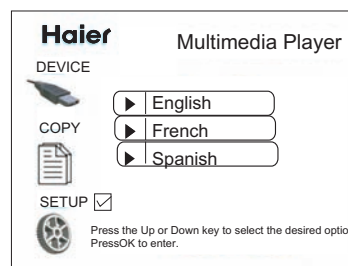

5 Press RETURN button to return.

Slideshow Model

1 After entering the SETUP menu.

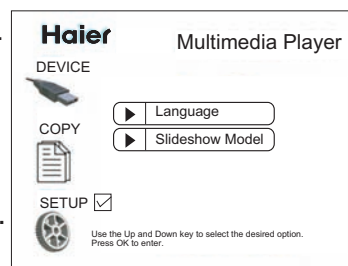

2 Press ▲/▼ to select **Slideshow Model** option, and then press OK button to enter the submenu.

3 Press ▲/▼ to select desired mode, and press OK to ensure it.

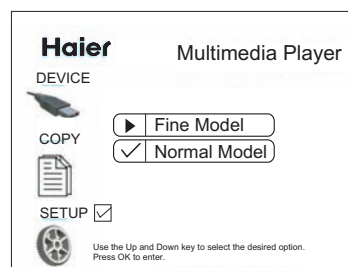

4 Press RETURN button to return.

■ Fine Model

Picture clarity high, the browsing speed is slow

■ Normal Model

Picture clarity normal, the browsing speed is quick

Maintenance

- Early malfunctions can be prevented. Careful and regular cleaning can extend the amount of time you will have your new TV. Be sure to turn the power off and unplug the power cord before you begin any cleaning.

Cleaning the Screen

1. Here's a great way to keep the dust off your screen for a while. Wet a soft cloth in a mixture of lukewarm water and a little fabric softener or dish washing detergent. Wring the cloth until it's almost dry, and then use it to wipe the screen.

2. Make sure the excess water is off the screen, and then let it air-dry before you turn on your TV.

Cleaning the Cabinet

To remove dirt or dust, wipe the cabinet with a soft, dry, lint-free cloth. Please be sure not to use a wet cloth.

Extended Absence

If you expect to leave your TV dormant for a long time (such as a vacation), it's a good idea to unplug the power cord to protect against possible damage from lightning or power surges.

Product Specifications

Resolution	1920*1080(Dot)
Power requirement	120V~ , 60Hz
Color System	NTSC, ATSC, Clear QAM
External Antenna Impedance	75 ohm
Color	16,770,000 (256 steps of each R, G and B)
Operating Temperature Range	32 ~ 104°F (0 ~ 40°C)
Operating Humidity Range	Less than 80%
Maximum Elevation	6561 feet (2000m)

MODEL	Dimensen(WXDXH) Unit::inches/mm (Including stand)	Weight (pounds / kg)
HL52E	57.5*13.6*40.7inches 1460*345*1034mm	125.5/56.9
HL47E	51.6*13*38.2 inches 1310*330*970mm	86.5/39.2
HL42E	48.1*12.5*34.7 inches 1207*317*881mm	80.5/43.4
HL37E	40.1*14*32.1 inches 1018*355*815 mm	77.25/35

■ The specifications shown above may be changed without prior notice for quality improvement.

Troubleshooting

For the sake of time and cost, it is strongly recommended that you check out the problem by yourself according to the instructions listed hereunder before contacting the after-sales service for technical assistance.

No picture, no sound	Verify if the television is properly plugged. Verify if the television is properly supplied power. Verify if electricity is available.
Blank screen	Verify if correct signals are input. Press INPUT button to change signal input to TV input. Restart the television if power supply is interrupted.
No sound	Press Mute button and verify if Mute mode is set. Switch to other channel and verify if the same problem happens. Press VOL+ button to see if the problem can be solved.
Poor sound	Verify if sound system is correct. Refer to some chapter for adjust.
No picture in some channel	Verify if correct channel is selected. Adjust the antenna. Make adjustments by Fine Tune and Manual Scan.
No color for some channel program (black and white)	Verify if the same problem exists in other channels. Check out of picture and sound systems. Refer to relative instructions in the Manual for color adjust.
Spots with some or all pictures	Verify if the antenna is correctly connected. Verify if the antenna is in good condition. Make fine adjustment of channel.
Horizontal/vertical bars or picture shaking	Check for local interference such as an electrical appliance or power tool.
Television out of control	Disconnect the television from power supply and, 10 seconds later, connect the television to the power supply. If the problem still exists, contact authorized after-sales service for technical assistance.

Note: Do not leave the television with static picture in an extended period as it may result in residual image on your television screen.

Note: Production of the plasma screen requires high and precision technologies. However, there might be some dark or bright (red, blue or green) spots, or some anomalous stripes or spots. This is not defect. If the TV set is used in an area 2,400 meters above the sea level where the air pressure is below 750hpa, the picture on the plasma screen may be affected and a muffled sound might be produced. These phenomena might happen in the area 1,500 meters above the sea level. This is resulted from difference between air pressures inside and outside the display. This is not a defect covered by the limited warranty.

Warranty

This Haier brand product, when shipped in its original container, will be free from defective workmanship and materials, and agrees that it will, at its option, either repair the defect or replace the defective product with a new or re-manufactured equivalent at no charge to the purchaser, for parts or labor for the periods set forth below:

This warranty does not apply to the appearance of the product or the exterior of the product, which has been damaged or defaced, altered or modified in design or construction. It does not apply to the additional excluded items set forth below:

The warranty commences on the date the item was purchased and the original purchase receipt must be presented to the authorized service center before warranty repairs are rendered.

The limited warranty described herein is in addition to whatever implied warranties may be granted to purchasers by law. **ALL IMPLIED WARRANTIES INCLUDING THE WARRANTIES OF MERCHANTABILITY AND FITNESS FOR USE ARE LIMITED TO THE PERIOD(S) FROM THE DATE OF PURCHASE SET FORTH BELOW.** Some states do not allow limitations on how long an implied warranty lasts, so the above limitation may not apply to you.

Neither the sales personnel of the seller nor any other person is authorized to make any warranties other than those described herein, or to extend the duration of any warranties beyond the time period described herein on behalf of Haier.

The warranties described herein shall be the sole and exclusive warranties granted by Haier and shall be the sole and exclusive remedy available to the purchaser. Correction of defects in the manner and for the period of time described herein, shall constitute complete fulfillment of all abilities and

Responsibility of Haier to the purchaser with respect to the product, and shall

constitute full satisfaction of all claims, whether based on contract, negligence, strict liability or otherwise. In no event shall Haier be liable, or in any way responsible for any damages or defects in the product which were caused by repairs or attempted repairs performed by anyone other than an authorized service center or dealer; nor shall Haier be liable, or in any way responsible for incidental or consequential economic or property damage. Some states do not allow the exclusion of incidental or consequential damages, so that above exclusion may not apply to you.

THIS WARRANTY GIVES YOU SPECIFIC LEGAL RIGHTS. YOU MAY ALSO HAVE OTHER RIGHTS WHICH VARY FROM STATE TO STATE.

Warranty period for this product: **one year parts and labor.**

Additional items excluded from warranty coverage: non-rechargeable batteries.

Where to obtain service: For the location of the nearest Haier authorized service center or to obtain product literature, accessories, supplies or customer assistance, please call 1-877-337-3639.

What to do to obtain service: ship or carry in your product to an authorized service dealer or center. Be sure to have proof of purchase. If you ship the product, be sure it is packaged carefully.

Haier America
New York, NY 10018

Haier

0090506979B (01)

Free Manuals Download Website

<http://myh66.com>

<http://usermanuals.us>

<http://www.somanuals.com>

<http://www.4manuals.cc>

<http://www.manual-lib.com>

<http://www.404manual.com>

<http://www.luxmanual.com>

<http://aubethermostatmanual.com>

Golf course search by state

<http://golfingnear.com>

Email search by domain

<http://emailbydomain.com>

Auto manuals search

<http://auto.somanuals.com>

TV manuals search

<http://tv.somanuals.com>