

Haier

TFT-LCD TV OWNER'S MANUAL

Please READ this manual carefully before operating your TV, and retain it for future reference.

Haier

Haier

MODELS:

HL37S ®

HL37B ®

HL42B ®

HL37BG ®

HL40BG ®

HL42BG ®

Haier

	WARNING RISK ELECTRIC SHOCK DO NOT OPEN	
<p>WARNING : To reduce the risk of electric shock do not remove cover or back. No user-serviceable parts inside refer service to qualified service personnel.</p>		

Operator Safety has been taken into consideration at the design and manufacture phase, but inappropriate operation may cause electric shock or fire. To prevent the product from being damaged, the following rules should be observed for the installation, use and maintenance of the product. Read the following safety instruction before starting the operation. The User Manual uses the following symbols to ensure a safe operation and prevent any damage to operators or properties:

	THIS SYMBOL INDICATES THAT HIGH VOLTAGE IS PRESENT INSIDE. IT IS DANGEROUS TO MAKE ANY KIND OF CONTACT WITH ANY INSIDE PART OF THIS PRODUCT.
---	---

	THIS SYMBOL INDICATES THAT THERE ARE IMPORTANT OPERATING AND MAINTENANCE INSTRUCTIONS IN THE LITERATURE ACCOMPANYING THE APPLIANCE.
--	--

FCC STATEMENT

This equipment has been tested and found to comply with the limits for a Class B digital device, pursuant to Part 15 of the FCC Rule. These limits are designed to provide reasonable protection against harmful interference in a residential installation. This equipment generates, use and can radiate radio frequency energy and, if not installed and used in accordance with the instructions, may cause harmful interference to radio communications. However there is no guarantee that interference will not occur in particular installation. If this equipment does cause harmful interference to radio or television reception, which can be determined by turning the equipment off and on, the user is encouraged to try to correct the interference by one or more of the following measures:

- *Reorient or relocate the receiving antenna.
- *Increase the separation between the equipment and receiver.
- *Connect the equipment into an outlet on a circuit different from that to which the receiver is connected.
- *Consult the dealer or an experienced radio/TV technician for help.

This device complies with Part 15 of the FCC Rules. Operation is subject to the following two conditions:

- (1) This device may not cause harmful interference, and
- (2) this device must accept any interference received, including interference that may cause undesired operation.

FCC CAUTION:

To assure continued compliance and possible undesirable interference, the provided ferrite cores must be used when connecting this plasma display to video equipment; and maintain at least 40cm spacing to other peripheral device.

CANADIAN NOTICE:

This Class B digital apparatus complies with Canadian ICES-003.

IMPORTANT SAFETY INSTRUCTIONS

Read all of the instructions before using this appliance. When using this appliance, always exercise basic safety precautions, including the following:

- 1) Read these instructions.
- 2) Keep these instructions.
- 3) Heed all warnings.
- 4) Follow all instructions.
- 5) Do not use this apparatus near water.
- 6) Clean only with dry cloth.
- 7) Do not block any ventilation openings. Install in accordance with the manufacturer's instructions.
- 8) Do not install near any heat sources such as radiators, heat registers, stoves, or other apparatus (including amplifiers) that produce heat.
- 9) Do not defeat the safety purpose of the polarized or grounding-type plug. A polarized plug has two blades with one wider than the other. A grounding type plug has two blades and a third grounding prong. The wide blade or the third prong are provided for your safety. If the provided plug does not fit into your outlet, consult an electrician for replacement of the obsolete outlet.
- 10) Protect the power cord from being walked on or pinched particularly at plugs, convenience receptacles, and the point where they exit from the apparatus.
- 11) Only use attachments/accessories specified by the manufacturer.
- 12) Use only with the cart, stand, tripod, bracket, or table specified by the manufacturer, or sold with the apparatus. When a cart is used, use caution when moving the cart/apparatus combination to avoid injury from tip-over.
- 13) Unplug this apparatus during lightning storms or when unused for long periods of time.
- 14) Refer all servicing to qualified service personnel. Servicing is required when the apparatus has been damaged in any way, such as power-supply cord or plug is damaged, liquid has been spilled or objects have fallen into the apparatus, the apparatus has been exposed to rain or moisture, does not operate normally, or has been dropped.
- 15) **WARNING-To Reduce The Risk Of Fire Or Electric Shock, Do Not Expose This Apparatus To Rain Or Moisture.** Apparatus shall not be exposed to dripping or splashing and no objects filled with liquids, such as vases, shall be placed on the apparatus.

PORTABLE CART WARNING
(symbol provided by RETAC)



S3126A

The apparatus shall not be exposed to dripping or splashing and that no objects filled with liquids, such as vases, shall be placed on the apparatus.

The mains plug is used as the disconnect device, remain it readily operable during the apparatus normal use.

SAVE THESE INSTRUCTIONS

Thank you for purchasing the Haier product. This easy-to-use manual will guide you in getting the best use of your product. Remember to record the model and serial number. They are on label in back of the unit.

Model number

serial number

Date of purchase

Staple your receipt to your manual. **You will need it to obtain warranty service.**

Contents

Warning	2	Time Menu	
Safety Instructions	3	Time zone setting.....	23
Introduction		Date /Time setting.....	24
Controls	6	Sleep Timer setting.....	24
Connection Options	7	Function Menu	
Universal Remote control	8	Menu Language.....	24
Installation		OSD Timeout.....	25
Accessories	9	OSD Transparency.....	25
Antenna Connection	9	Blue Screen.....	25
VCR Connection	9	DPMS.....	25
External A/V Source Setup	11	DTV Caption Style.....	25
DVD Connection	12	Adjust Menu	
DTV Connection.....	12	Screen Setup for PC mode	26
Digital Audio Output	12	Lock Menu	
PC Connection.	13	Parental Control rating and categories.....	27
HDMI	14	Lock setup.....	28
Cable sample.....	15	Others Functions	
Connecting Headphones	16	Brief Info.	30
Power source.....	16	Quick program view.....	30
Take the table stand off	17	Aspect Ratio Control	31
Operation		CC (Closed Caption Display)	31
Switching On/Off the TV set	18	Remote Control	
Choose the Menu Language	18	Setting up your remote control	32
Choose the input source.....	18	Remote Control Codes	34
Channel Menu		Maintenance	38
Channel Scan.....	19	Product Specifications	39
Channel Skip.....	19	Troubleshooting	40
Select the desired program.	20	Warranty	41
Select the desired sound.	20		
Mute.	20		
Video Menu			
How to select picture mode.....	21		
How to customize your own picture status	21		
Audio Menu			
How to select audio mode.....	22		
How to customize your own audio status	22		
SAP Broadcasts Setup.....	23		

Controls

This is a simplified representation of front panel.
Here shown may be somewhat different from your TV.

Front panel controls

HL37B® HL42B® HL37BG® HL40BG® HL42BG®

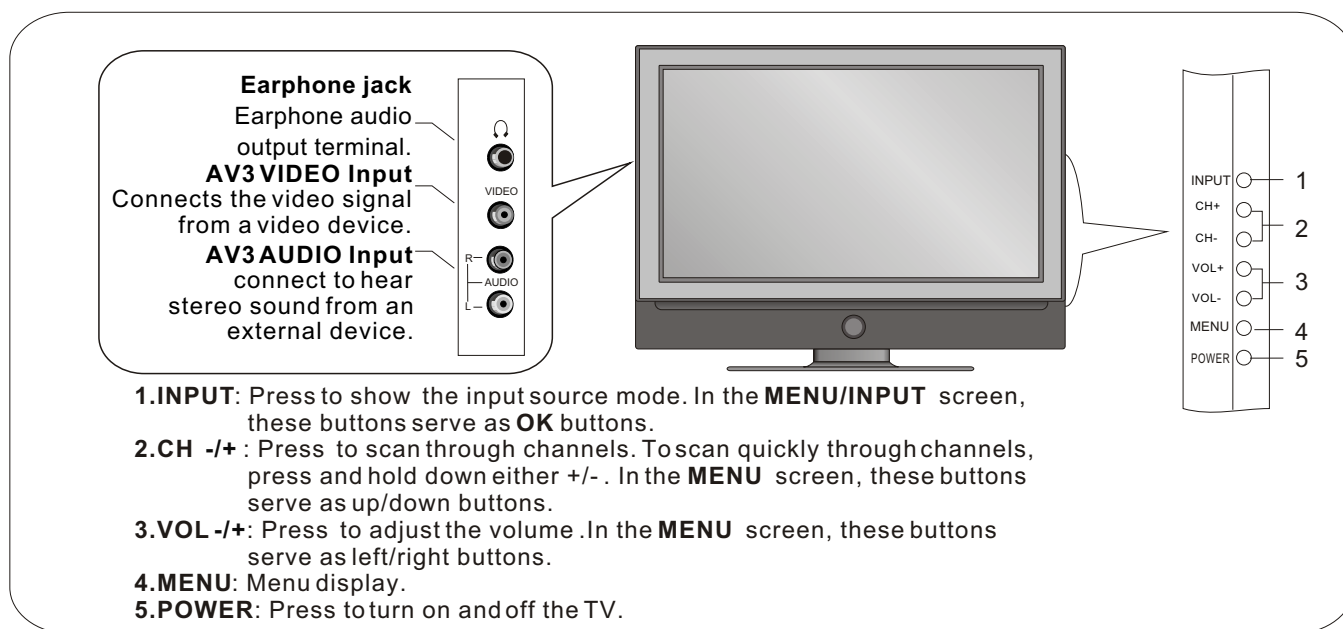

HL37S®

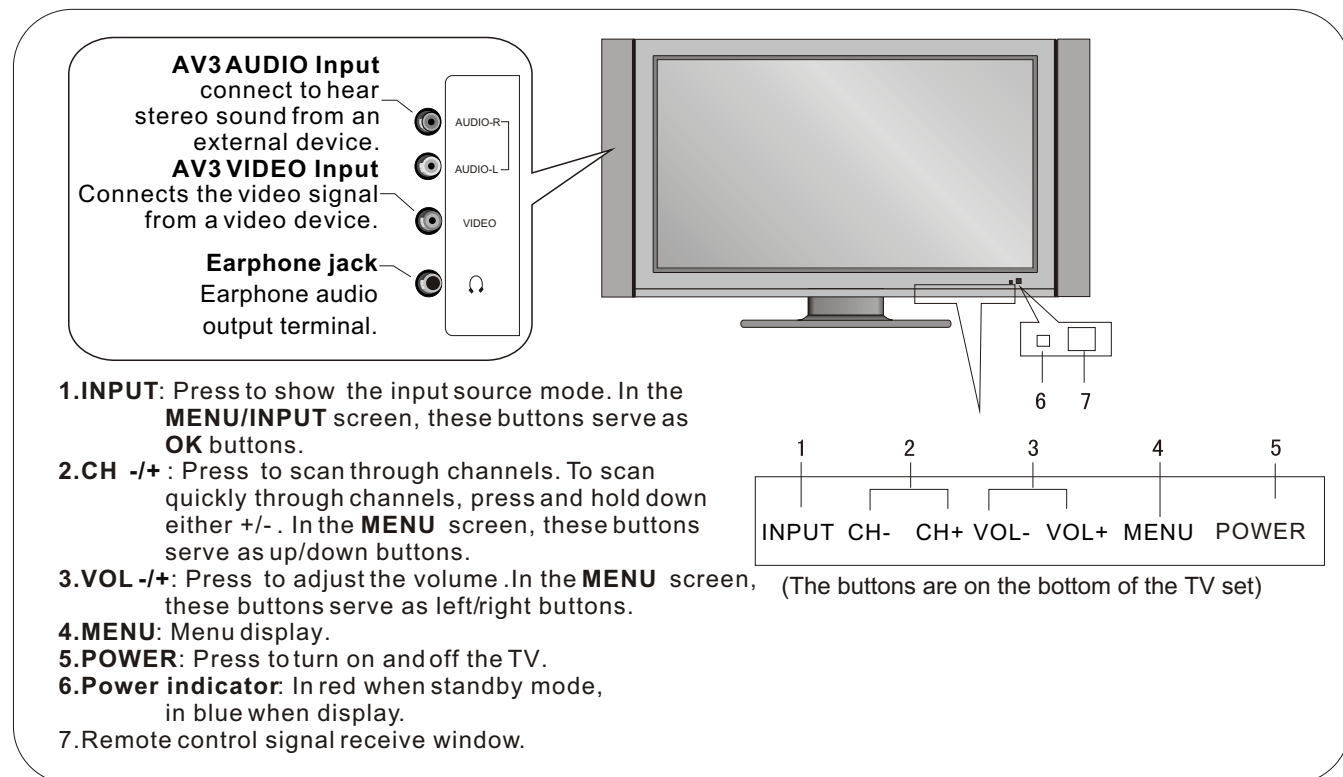

Connection Options

Back panel controls

HL37S® HL37B® HL42B® HL37BG® HL40BG® HL42BG®

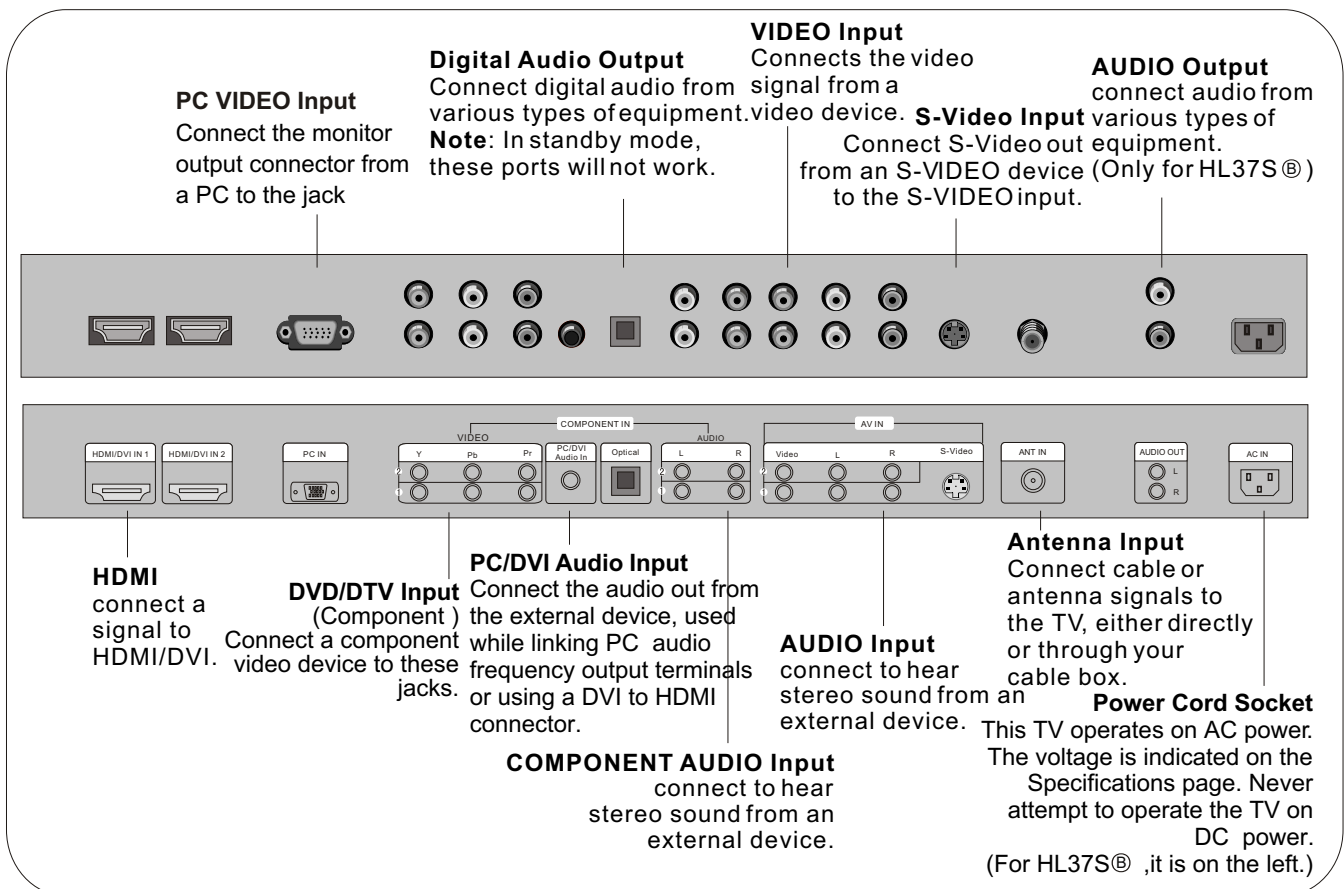

Universal Remote control

The remote control cannot be operated unless the batteries are properly loaded. When using the remote control, aim it at the remote control sensor on the TV.

Function introduction

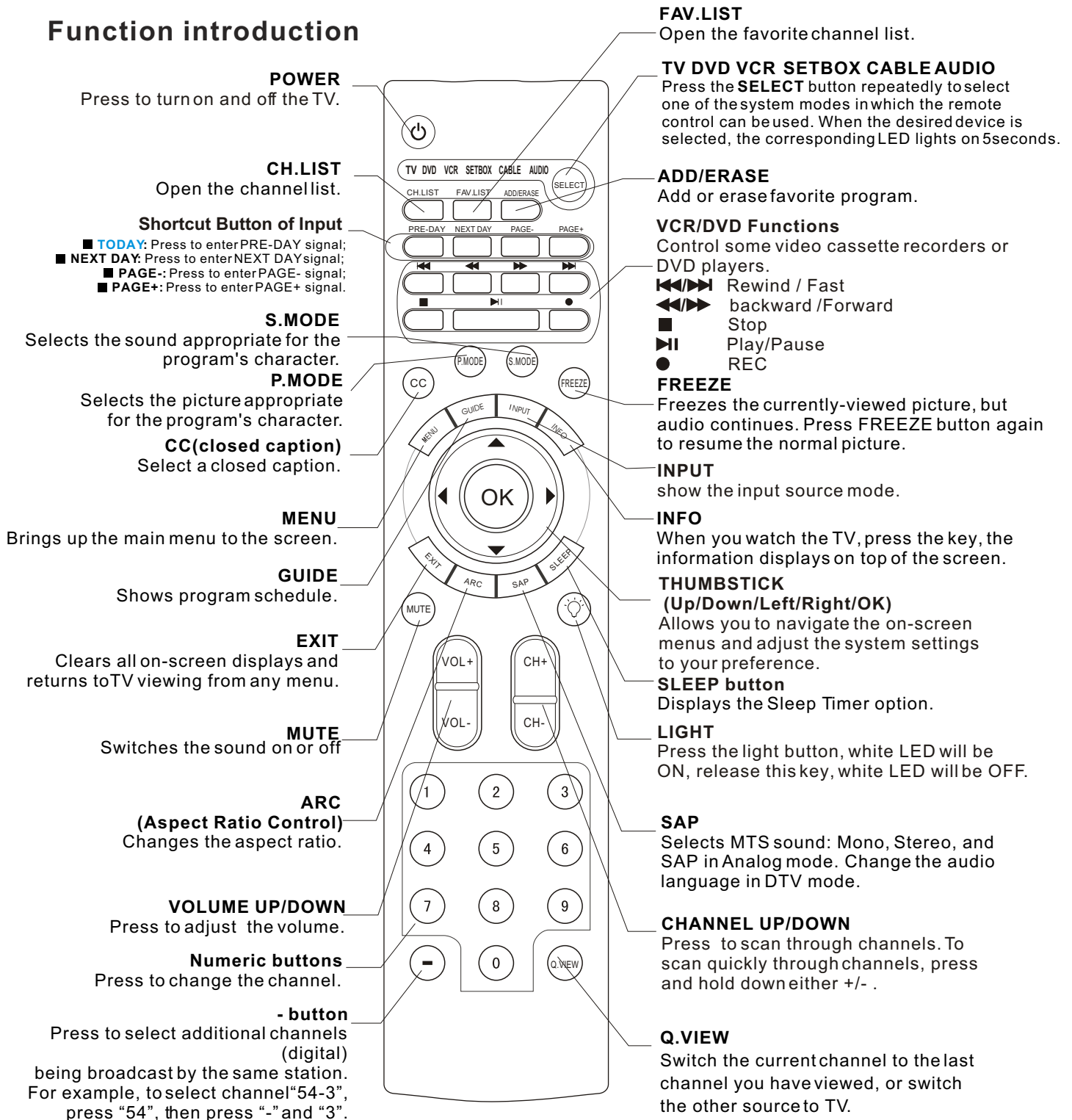

External Equipment Connections

Accessories



Remote control

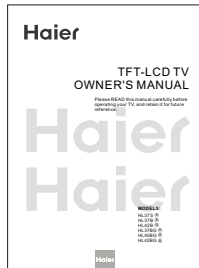

Owner's manual

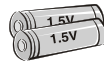

Alkaline battery(AAA)×2

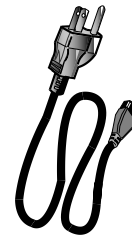

Power cable

Antenna Connection

Generally speaking, to enjoy a clearer picture, we recommend that you use a CATV system or an outdoor antenna. Over-the-air TV reception quality will depend on your antenna type, antenna location and antenna positioning.

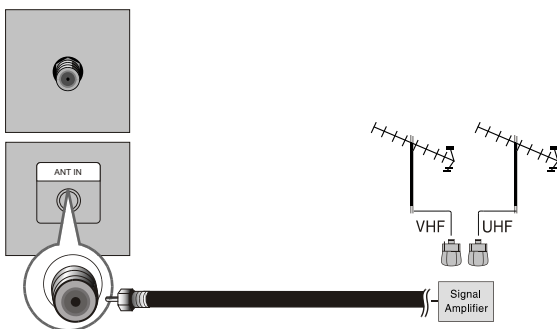
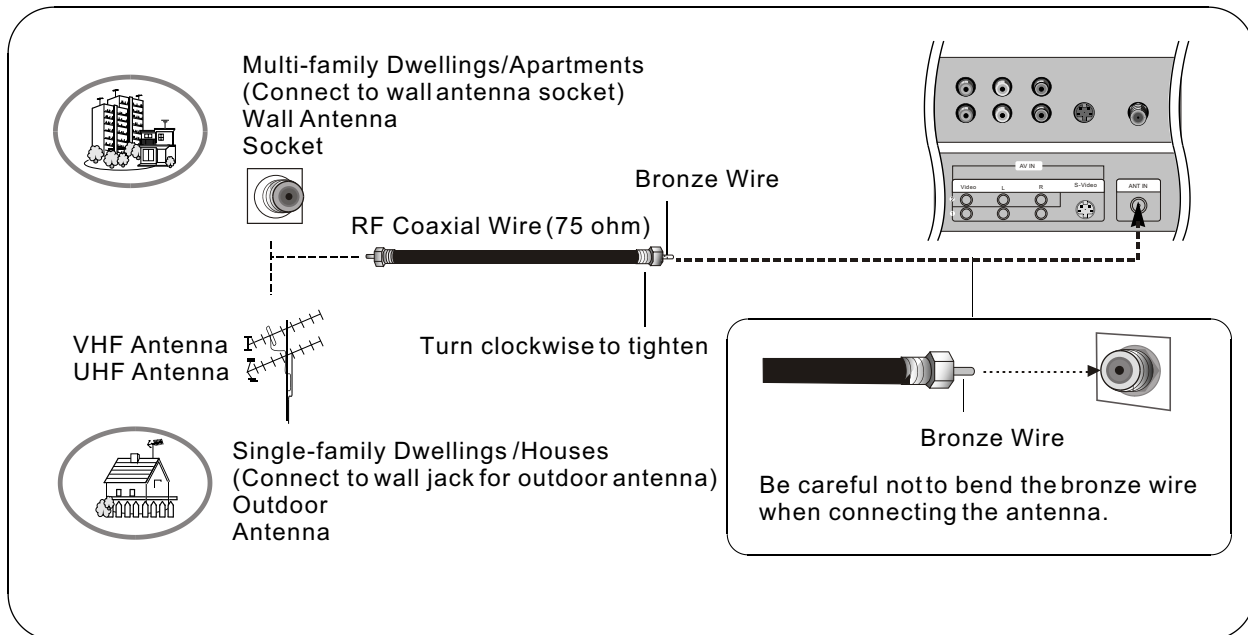

- To improve the picture quality in a poor signal area, please purchase a signal amplifier and install properly.
- If the antenna needs to be split for two TV's, install a "2-Way Signal Splitter" in the connections.
- To install the antenna properly please contact a professional in your area.

External Equipment Connections

NOTE: All cables shown are not included with the TV.

Choose Your Connection

There are several ways to connect your television, depending on the components you want to connect and the quality of the signal you want to achieve. The following are examples of some different ways to connect your TV with different input sources.

VCR connection

To avoid picture noise (interference), leave an adequate distance between the VCR and TV.

Connection Option 1

Set VCR output switch to channel 3 or 4 and then tune the TV to the same channel number.

Connection Option 2

1. Connect the audio and video cables from the VCR's output jacks to the TV input jacks, as shown in the figure.

When connecting the TV to VCR, match the jack colors (Video = yellow, Audio Left = white, and Audio Right = red).

If you connect an S-VIDEO output from VCR to the S-VIDEO input, the picture quality is improved; compared to connecting a regular VCR to the Video input.

2. Insert a video tape into the VCR and press PLAY on the VCR. (Refer to the VCR owner's manual.)

3. Select the input source with using the INPUT button on the remote control, and then press ▲/▼ button to select the source, press the OK button to confirm.

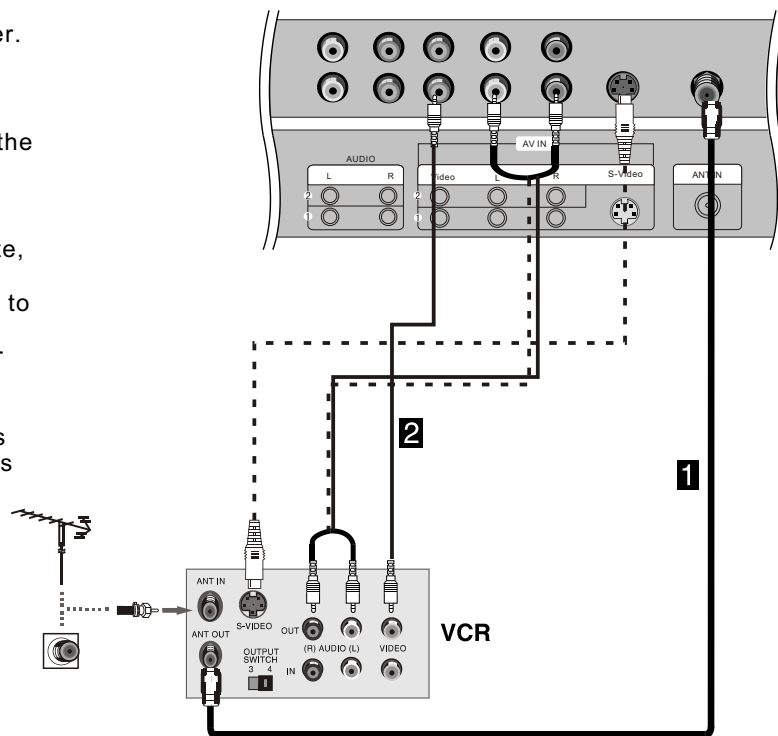

External Equipment Connections

External A/V Source Setup

How to connect

Connect the audio and video cables from the external equipment's output jacks to the TV input jacks, as shown in the figure.

When connecting the TV to external equipment, match the jack colors (Video = yellow, Audio Left = white, and Audio Right = red).

How to use

1. Select the input source with using the INPUT button on the remote control.
2. Press the ▲ / ▼ button to select the desired source.
3. Press the OK button to confirm.
2. Operate the corresponding external equipment.

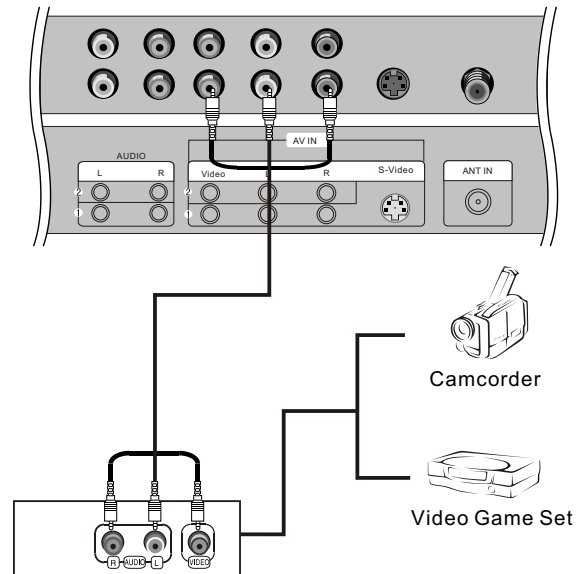

DVD connection

How to connect

1. Connect the DVD video outputs (COMPONENT) to the Y Pb Pr jacks on the TV and connect the DVD audio outputs to the YPbPr Audio IN jacks on the TV, as shown in the figure.
2. If your DVD only has an S-VIDEO output jack, connect this to the S-VIDEO input on the TV. as shown in the figure.

Note

If your DVD player does not have component video output, use S-Video.

How to use

1. Turn on the DVD player, insert a DVD.
2. Use the INPUT button on the remote control to select Y Pb Pr mode.
3. Press Play button on external equipment for program play.
4. Refer to the DVD player's manual for operating instructions.

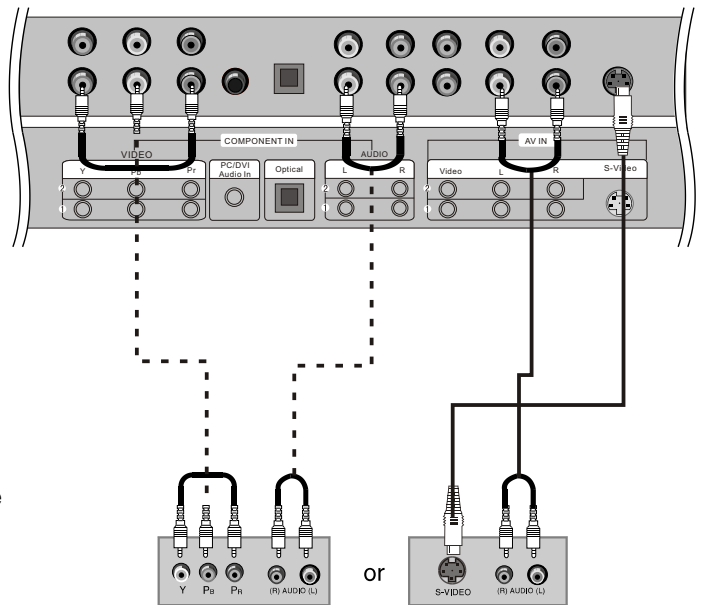

■ Component Input ports

To get better picture quality, connect a DVD player to the component input ports as shown below.

Component ports on the TV	Y	Pb	Pr
Video output ports on DVD player	Y	Pb	Pr
	Y	B-Y	R-Y
	Y	Cb	Cr
	Y	P _B	P _R

Note

The audio input terminal of AV IN 1 is compared with S-VIDEO.

External Equipment Connections

DTV connection

This TV can receive Digital Over-the-air/Cable signals without an external digital set-top box. However, if you do receive Digital signals from a digital set-top box or other digital external device, refer to the figure as shown below. This TV supports HDCP (High-bandwidth Digital Contents Protection) protocol for Digital Contents (480p, 720p, 1080i).

How to connect

Use the TV's **COMPONENT**, **PC** or **HDMI/DVI** jack for video connections, depending on your set-top box connector. Then, make the corresponding audio connections.

How to use

1. Turn on the digital set-top box. (Refer to the owner's manual for the digital set-top box.)
2. Use INPUT on the remote control to select **COMPONENT**, **PC** or **HDMI/DVI** source.

Signal	COMPONENT	HDMI/DVI
480i	Yes	Yes
480p	Yes	Yes
720p	Yes	Yes
1080i	Yes	Yes

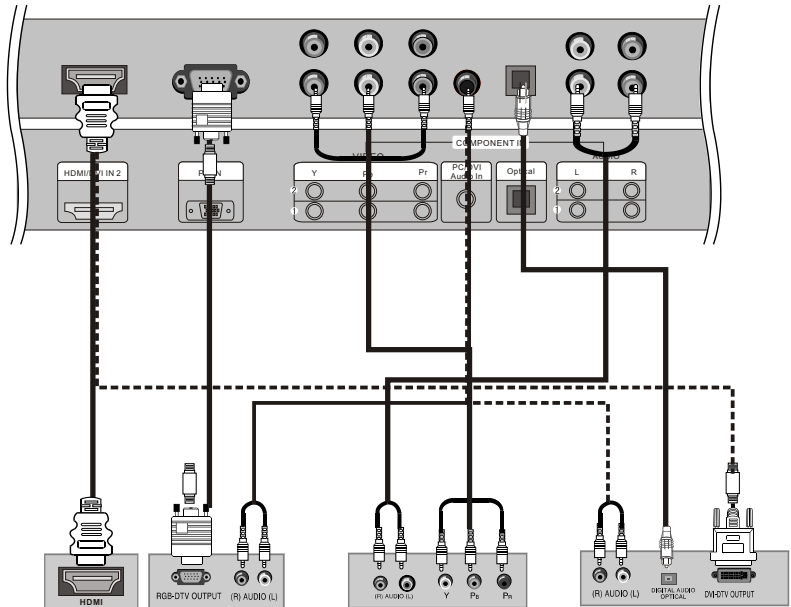

Digital Set-top Box

Digital Audio Output

Send the TV's audio to external audio equipment (stereo system) via the Digital Audio Output (Optical) port.

How to connect

1. Connect one end of an optical cable to the TV Digital Audio (Optical) Output port.
2. Connect the other end of the optical cable to the digital audio (optical) input on the audio equipment. See the external audio equipment instruction manual for operation.

Note

When connecting with external audio equipments, such as amplifiers or speakers, please turn the TV speakers off.

Caution: Do not look into the optical output port. Looking at the laser beam may damage your vision.

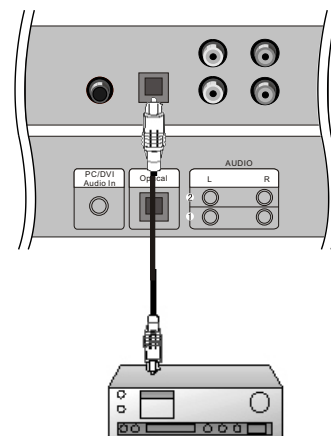

External Equipment Connections

PC connection

How to connect

1. To get the best picture quality, adjust the PC graphics card to 1024x768.
2. Use the TV's PC or DVI (Digital Visual Interface) Audio IN port for video connections, depending on your PC connector.
 - If the graphic card on the PC does not output analog and digital RGB simultaneously, connect only one of either PC IN or HDMI/DVI IN to display the PC on the TV.
 - If the graphic card on the PC does output analog and digital RGB simultaneously, set the TV to either PC or HDMI/DVI; (the other mode is set to Plug and Play automatically by the TV.)
3. Then, make the corresponding audio connection. If using a sound card, adjust the PC sound as required.

How to use

1. Turn on the PC and the TV.
2. Turn on the display by pressing the POWER button on the TV's remote control.
3. Use INPUT on the remote control to select PC or HDMI/DVI source.
4. Check the image on your TV. There may be noise associated with the resolution, vertical pattern, contrast or brightness in PC mode. If noise is present, change the PC mode to another resolution, change the refresh rate to another rate or adjust the brightness and contrast on the menu until the picture is clear. If the refresh rate of the PC graphic card can not be changed, change the PC graphic card or consult the manufacturer of the PC graphic card.

Note

1. Use a DVI cable.
2. Avoid keeping a fixed image on the TV's screen for a long period of time. The fixed image may become permanently imprinted on the screen.
3. The synchronization input form for Horizontal and Vertical frequencies is separate.

Resolution

Mode	Resolution	Frame frequency (Hz)
VGA	640*480	60Hz
SVGA	800*600	60Hz/75Hz
XGA	1024*768	60Hz
		75Hz

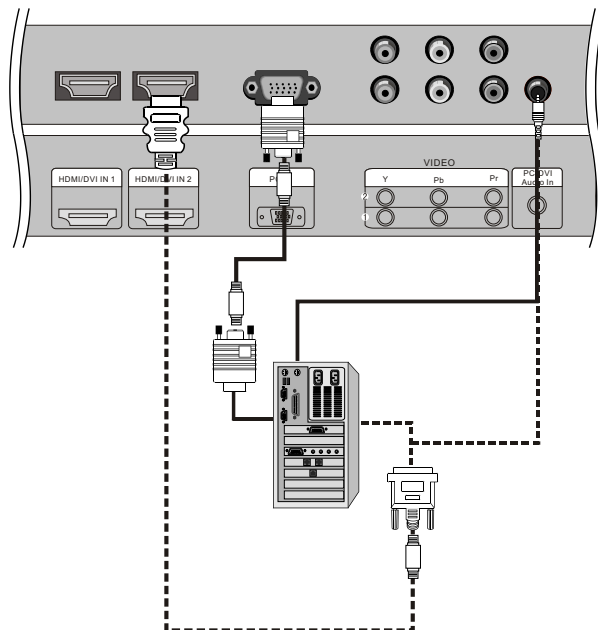

HDMI

When the source device(DVD player or Set Top Box) supports HDM

How To Connect

1. Connect the source device to HDMI port of this TV with an HDMI cable(not supplied with this product).
2. No separated audio connection is necessary.

How To Use

If the source device supports Auto HDMI function, the output resolution of the source device will be automatically set to 1280x720p.

If the source device does not support Auto HDMI, you need to set the output resolution appropriately.

To get the best picture quality, adjust the output resolution of the source device to 1280x720p.

Select HDMI input source in input source option of Select Main source menu.

When the source device(DVD player or Set Top Box) supports DVI

How To Connect

1. Connect the source device to HDMI port of this TV with a HDMI-to-DVI cable(not supplied with this product).
2. A separated audio connection is necessary.
3. If the source device has an analog audio output connector, connect the source device audio output to DVI Audio In port located on the left side of HDMI port.

How To Use

If the source device supports Auto DVI function, the output resolution of the source device will be automatically set to 1280x720p.

If the source device does not support Auto DVI, you need to set the output resolution appropriately.

To get the best picture quality, adjust the output resolution of the source device to 1280x720p.

Press the INPUT button to select HDMI input source in input source option of Select Main source menu.

Cable sample

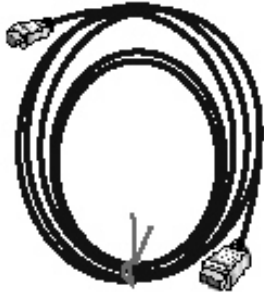

HDMI Cable
(not supplied with the product)

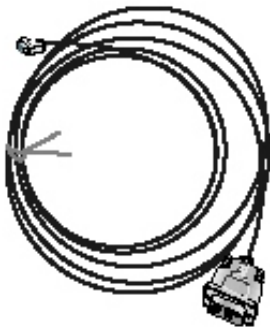

HDMI to DVI Cable
(not supplied with the product)

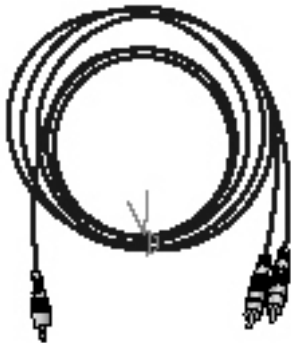

Analog Audio Cable
(Stereo to RCA type)
(not supplied with the product)

External Equipment Connections

Connecting Headphones

You can connect a set of headphones to your set if you wish to watch a TV programme without disturbing the other people in the room.

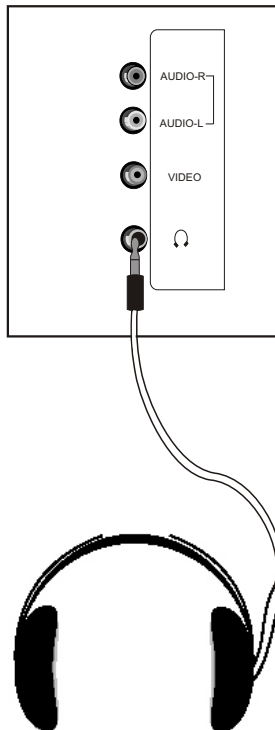

Plug a set of headphones into the 3.5mm mini-jack socket on the side panel of the set.

Note

- Prolonged use of headphones at a high volume may damage your hearing.
- You will not receive sound from the speakers when you connect headphones to the system.

Power source

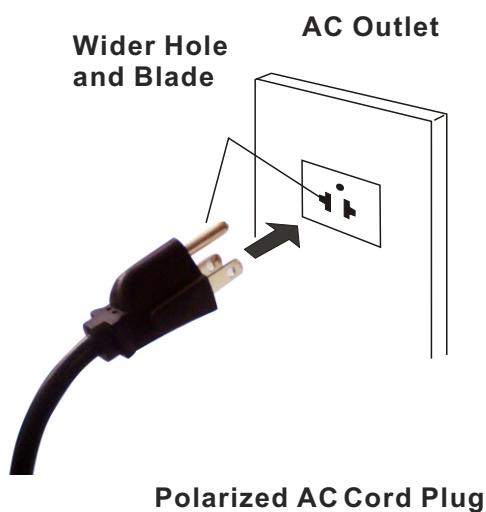

TO USE AC POWER SOURCE

Use the AC polarized line cord provided for operation on AC. Insert the AC cord plug into a standard polarized AC outlet.

Note

- Never connect the AC line cord plug to other than the specified voltage. Use the attached power cord only.
- If the polarized AC cord does not fit into a non-polarized AC outlet, do not attempt to file or cut the blade. It is the user's responsibility to have an electrician replace the obsolete outlet.
- If you cause a static discharge when touching the unit and the unit fails to function, simply unplug the unit from the AC outlet and plug it back in. The unit should return to normal operation.

Take the table stand off

You can take off the table stand if you don't want to use the table stand.

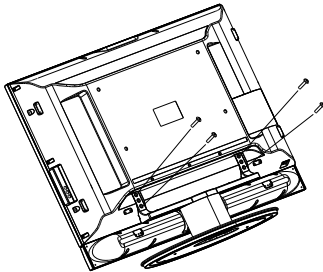

HL37B® HL42B® HL37BG® HL40BG® HL42BG®
Please release the screws 4XM4,
see the picture.

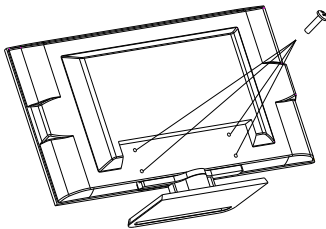

HL37S®
Please release the screws 6XM5,
see the picture.

Operation

In the manual, the OSD (on screen display) may be different from your TV's, because it is just an example to help you with the TV operation.

There are several options you might need to set up in order for your TV to work properly. Read the instructions that follow.

Switching On/Off the TV set

1. First, connect power cord correctly.
2. Select the viewing source by using **INPUT** button on the remote control.
3. When finished using the TV, press the **POWER** button on the remote control. The TV reverts to standby mode.
4. If you intend to be away on vacation, disconnect the power plug from the wall power outlet.

Note

If the TV is in power on, the screen shows information according to the type of input signal. The information will disappear. If there is no signal, "No Signal" will display on the screen.

Choose the Menu Language

When you start using your set for the first time, you must select the language which will be used for displaying menus and indications.

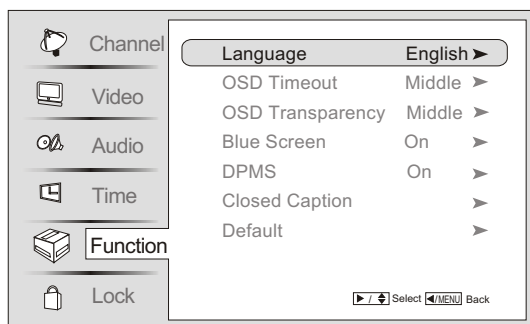

- 1 Choose the **TV** Input and then press the **MENU** button.
- 2 use **▲/▼** button to select the **Function** menu.
- 3 Press the **▶** or **OK** button and then use **▲/▼** button to select **Language**.
- 4 Press the **▶** button to select language.
(**English, Spanish or French**)
- 5 When you are satisfied with your choice, press the **EXIT** button to return to normal viewing or press **MENU** button to return to the previous menu.

Choose the Input source

Change the picture source so you can watch your TV, cable TV, VCR, DVD, or any other devices that are connected to your TV.

1. Press the **INPUT** button to enter the Select Main picture Source menu and then use **▲/▼** button to select the desired items (TV, Video1, Video2, Video3, S-Video, Component1, Component2, PC, HDMI1, HDMI2) .
2. Press the **OK** button to confirm .

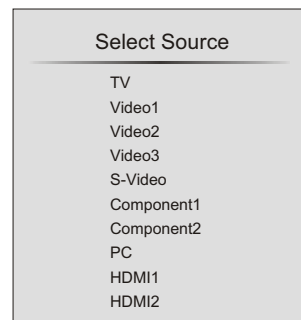

Channel menu

■ This TV set has two methods to set channels, which are respectively Auto Scan, Add Channel Scan.
 ■ In this section, how to use the remote control to set channel is explained. You can also use buttons on the TV set to set channel.

Note

The Channel menu will be only operated in normal TV mode.

Channel Scan

- 1 Press the **MENU** button and then use ▲/▼ button to select the **Channel** menu.
- 2 Press the ► or **OK** button and then use ▲/▼ button to select **Tuner**.
- 3 Press the ► button. Select **Cable** or **Antenna** mode.
- 4 Press the ▲/▼ button to select **Channel Scan**.
- 5 Press the ► or **OK** button to start searching.
- 6 To cancel searching, press the **EXIT** button.

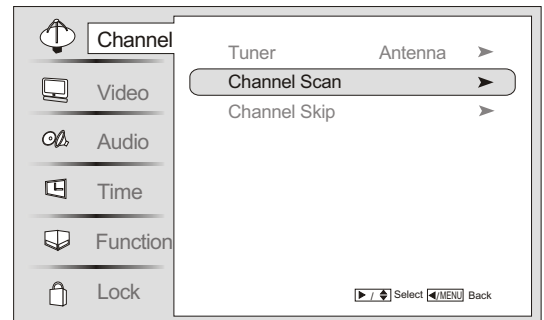

Note

When **Antenna** is selected, the TV will detect antenna signals and will search for antenna TV (NTSC and ATSC) channels available in your local area.

When **Cable** is selected, the TV will detect cable company supplied signals and will search for cable TV (NTSC, QAM modulated) channels available in your area.

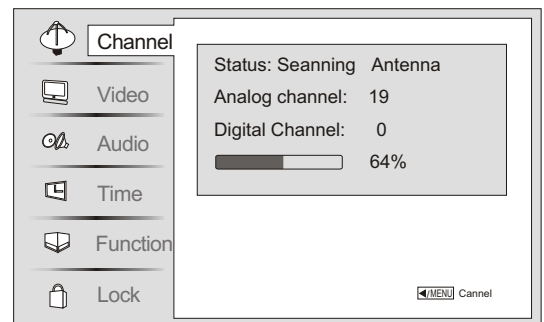

Channel Skip

A skip channel is skipped when using CH+ and CH- button to browse the channels. A skip channel can be watch by key-in the channel number or select by list.
 Default un-scanned analog channels are skip.
 Channel with a check icon is ✓ a skipped channel.

- 1 Press the **MENU** button and then use ▲/▼ button to select the **Channel** menu.
- 2 Press the ► button and then use ▲/▼ button to select **Channel Skip**.
- 3 Press the ► button. Select .

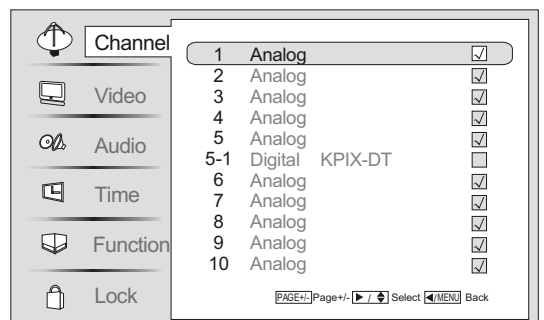
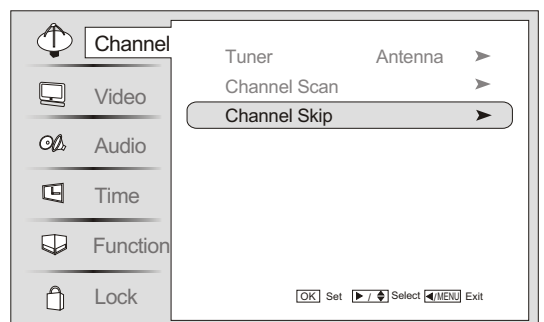

Select the desired program

1 Using the CH+/- buttons.

- Press the CH+ button to select a channel number in number increasing direction.
- Press the CH- button to select a channel number in number decreasing direction.

Note

If Skip is ON on one channel, press CH+/- button, the channel will not appear.

2 Also can enter channel number directly, eg:2-0.

Select the desired sound

Press the VOL-/+ buttons on the remote or the front of the TV set to adjust the volume level. The range is 0~100. When the volume buttons are pressed the volume level is displayed automatically on the TV screen.

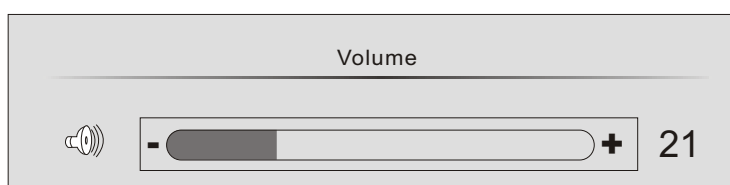

Mute

When you need to pay attention to a conversation, or there is a telephone calling you or there are some guests visiting you, the sound elimination (mute) function is very convenient.

1 Press the **MUTE** button on the remote control and “” type face will display on the screen. At this time, the sound of the TV set is turned off.

2 If you want to recover the sound, press the **MUTE** button again or directly press **VOL+** buttons.



Video menu

The TV menu gives you an overview of the menus you can select.

Note

Depending on the input signal, one or more menu items may not be selectable.

How to select picture mode

The picture mode provides the pre-defined images settings. There are four settings: Standard, Vivid, Custom and Mild.

Press **P.MODE** button on the remote control to select the option (Standard/ Vivid/ Custom/ Mild)

How to customize your own picture status

- 1 Press the **MENU** button and then use **▲ / ▼** button to select the **Video** menu.
- 2 Press the **▶** button and then use **▲ / ▼** button to select the desired items.
- 3 Press the **▶** or **OK** button and then use **◀ / ▶** button to adjust the setting.
- 4 When you are satisfied with your choice, press **MENU** button to return to the previous menu or press the **EXIT** button to return to TV viewing.

■ Mode

Select the mode of picture (**Custom, Cinema, Sport, vivid and Hi-Bright**).

■ Brightness

This will adjust the light output of the complete picture, which will mainly affect the darker areas of the picture.

■ Contrast

This will adjust the intensity of bright parts in the picture but keep the dark parts unchanged.

■ Color

This will adjust the saturation level of the colors to suit your personal preference.

■ Tint

Allows you to select the color mix (Tint) of the picture.

■ Sharpness

This will adjust the sharpness of fine details in the picture.

■ Color temperature

This will increase or decrease **Warm** (red) and **Cold** (blue) colors to suit personal preferences. Select **Cold** to give the white colors a blue tint, **Standard** to give the white colors a neutral tint, **Warm** to give the white colors a red tint.

■ Advanced Video

To adjust the picture in advanced: DNR, Black Level Extender, White Peak Limiter, CTI, Flech Tone, Adaptive Luma Control.

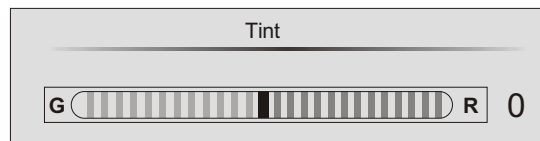
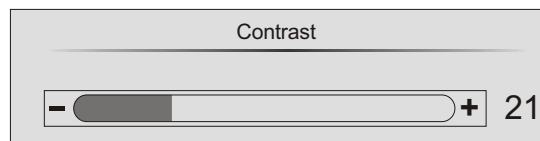
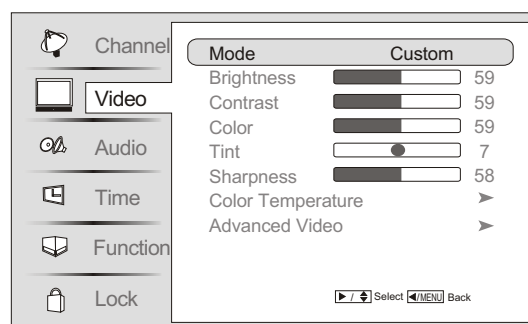

Note

Only when the item of mode is custom, the Contrast, Brightness, Tint, color, Sharpness and Color Temperature can be set by user. In other mode the value of them are preset by program.

Video menu

■ DNR

To adjust reduce the appearance of digitizing error by the compression: Off, Weak, Medium and Strong.

■ Black Level Extender

To adjust the ability in the black areas detail of the picture: On and Off.

■ White Peak Limiter

To adjust the ability in the white areas detail of the picture: On and Off.

■ CTI

To adjust the picture for color errors: Off, Weak, Medium and Strong.

■ Flech Tone

To adjust the flesh color: On and Off.

■ Adaptive Luma Control

To adjust changes in the luminance of the picture: On and Off.

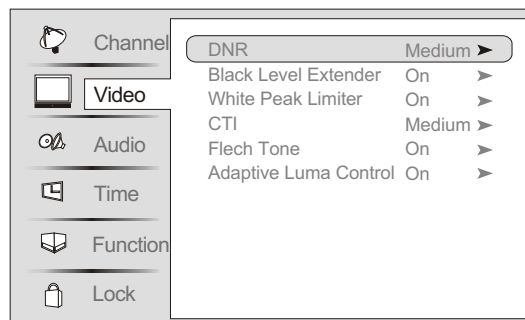

Audio menu

How to Select Audio mode

Press **S.MODE** button on the remote control to select the Audio Mode (Off, Concert, Living Room, Hall, Bathroom, Cave, Arena and Church).

How to Customize your own audio status

- 1 Press the **MENU** button and then use **▲ / ▼** button to select the **Audio** menu.
- 2 Press the **▶** button and then use **▲ / ▼** button to select the desired items.
- 3 Press the **▶** or **OK** button and then use **◀ / ▶** button to adjust the setting.
- 4 When you are satisfied with your choice, press **MENU** button to return to the previous menu or press the **EXIT** button to return to TV viewing.

■ Balance

Adjust to emphasize left or right speaker balance.

■ Bass

Adjust to increase or decrease lower-pitched sounds.

■ Treble

Adjust to increase or decrease higher-pitched sounds.

■ Sound Surround

To turn the simulated surround sound on and off.

■ Audio Mode

To adjust the audio mode: Off, Concert, Living Room, Hall, Bathroom, Cave, Arena and Church

■ Equalizer

To adjust the equalizer: Off, Rock, Pop, Live, Dance, Techno, Classic and Soft.

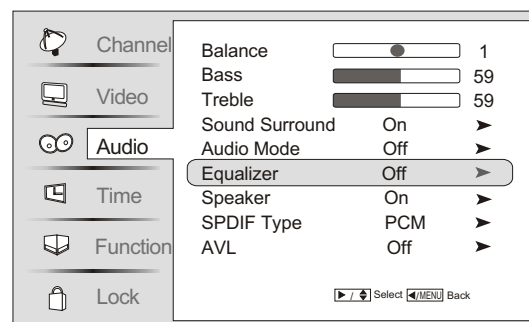

Audio menu

■ Speaker

Press the ► or **OK** button to switch **ON** or **OFF** of the loudspeaker
When the digital audio function(optical) is used.

■ SPDIF Type

To Adjust the SPDIF output: Off, Dolby Digital and PCM.

■ AVL(Automatic Volume Control)

This will reduces the differences in volume level among
broadcasters.

SAP Broadcasts Setup

This TV can receive MTS stereo programs and SAP
(Secondary Audio Program) that accompanies the stereo program;
if the station transmits an additional sound signal as well as the original one.
When having selected SAP button on the remote control, this TV can only
receive the signal when the TV station transmits the proper signals.
Mono sound is automatically received if the broadcast is only in Mono; even
though Stereo or SAP has been selected.
Select Mono if you want to listen to mono sound during stereo/SAP
broadcasting.
Stereo or SAP can be received in a Analog channel.

1. Use the **SAP** button to select your desired MTS mode in a analog signal.
Each time you press the **SAP** button, **Mono**, **Stereo** or **SAP** appear.
If other languages are available on the digital signal, select them with the
SAP button.
2. Press **EXIT** button to save and return to TV viewing.

Time menu

Time zone setting

This function allows you to select your local time zone.
Broadcasted time information will correct the clock display
for your local time.

- 1 Press the **MENU** button and then use ▲ / ▼ button to
select the **Time** menu.
- 2 Press the ► button and then use ▲ / ▼ button to select
the **Time Zone** items.
- 3 Press the ► button to select your viewing area time
zone: **Eastern, Indiana, Central, Mountain, Arizona,**
Pacific, Alaska or **Hawaii** .
- 4 When you are satisfied with your choice, press **MENU**
button to return to the previous menu or press the **EXIT**
button to return to TV viewing.

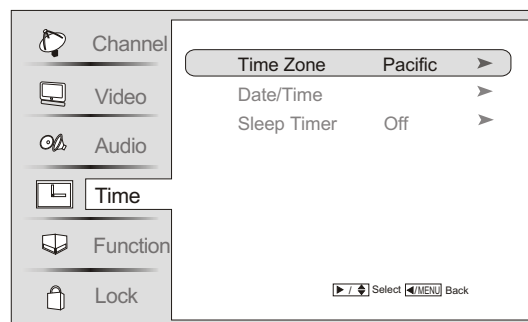

Time menu

Date /Time setting

Setting the clock is necessary in order to use the various timer features of the TV. Also, you can check the time while watching the TV.

- 1 Press the **MENU** button and then use **▲/▼** button to select the **Time** menu.
- 2 Press the **▶** button and then use **▲/▼** button to select the **Date/Time**.
- 3 Press the **▶** or **OK** button and then use **◀/▶** button to select the Mode: **Manual** or **Auto**.
- 4 When you are satisfied with your choice, press **MENU** button to return to the previous menu or press the **EXIT** button to return to TV viewing.

Sleep Timer setting

The sleep timer automatically shuts off the TV after a preset time (from 5 to 240 minutes).

- 1 Press the **MENU** button and then use **▲/▼** button to select the **Time** menu.
 - 2 Press the **▶** button and then use **▲/▼** button to select the **Sleep Timer**.
 - 3 Press the **▶** button to select the number of minutes.
Select **Off, 5Min, 10Min, 15Min, 30Min, 45Min, 60Min, 90Min, 120Min, 180Min** or **240Min**.
The time begins to count down from the number of minutes selected.
 - 4 When you are satisfied with your choice, press **MENU** button to return to the previous menu or press the **EXIT** button to return to TV viewing.
 - 5 To cancel the set sleep timer: Press the **▶** button to select **Off**.
- You can use the **SLEEP** button also to select quickly the sleep timer.

Function menu

Menu Language

When you start using your set for the first time, you must select the language which will be used for displaying menus and indications.

- 1 Press the **MENU** button and then use **▲/▼** button to select the **Function** menu.
- 2 Press the **▶** button and then use **▲/▼** button to select **Language**.
- 3 Press the **▶** button to select language.
(**English, Spanish or French**)
- 4 When you are satisfied with your choice, press the **EXIT** button to return to normal viewing or press **MENU** button to return to the previous menu.

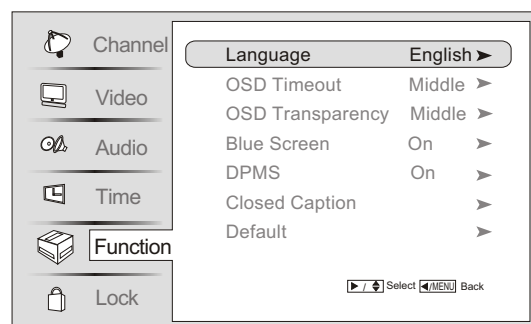
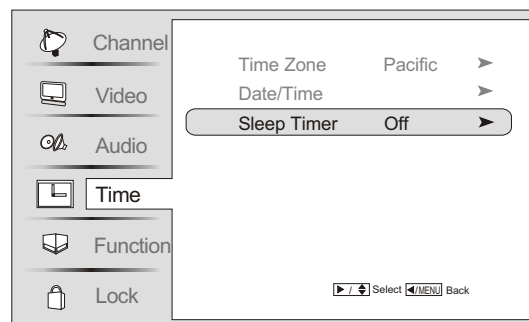
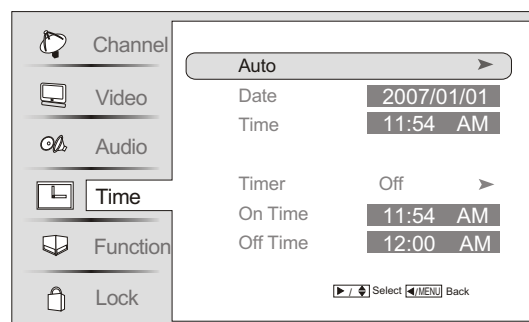
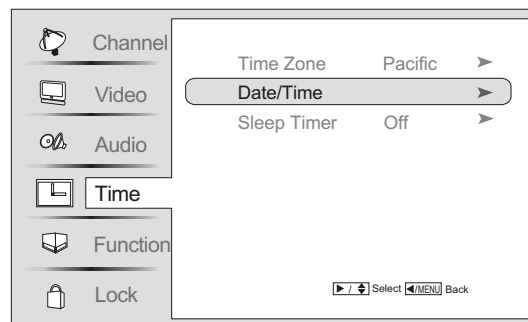

Function menu

OSD Timeout

1. Press the **MENU** button and then use **▲/▼** button to select the **Function** menu.
2. Press the **▶** button and then use **▲/▼** button to select **OSD Timeout**.
3. Press the **▶** button to select **short, middle or Long**. (Short is for 5 seconds; middle is for 10 seconds; Long is for 15seconds)

OSD Transparency

1. Press the **MENU** button and then use **▲/▼** button to select the **Function** menu.
2. Press the **▶** button and then use **▲/▼** button to select **OSD transparency**.
3. Press the **▶** button to select **Low ,middle or High**.

Blue Screen

1. Press the **MENU** button and then use **▲/▼** button to select the **Function** menu.
2. Press the **▶** button and then use **▲/▼** button to select **Blue Screen**.
3. Press the **▶** button to select **On** or **Off**.

DPMS

PC Power Management. when this function is open, if no PC signal, automatic being dormant for three minutes, if having PC signal, automatic power.

DTV Caption Style (In DTV mode)

This allows you to modify how digital captions are displayed on your TV. Select from the following options to change the visual characteristics of your TV's digital captioning.

Customize the DTV/CADTV captions that appear on your screen.

1. Press the **MENU** button and then use **▲/▼** button to select the **Function** menu.
2. Press the **▶** button and then use **▲/▼** button to select **Closed Caption**.
3. Press the **▶** button and then use **◀/▶** button to select **DTV Caption Style**.
4. Press the **▶** button and then Use **▲/▼** button to select the Style, Size, etc., press **◀/▶** button to customize to your preference.
5. When you are satisfied with your choice, press **MENU** button to return to the previous menu or press the **EXIT** button to return to TV viewing.

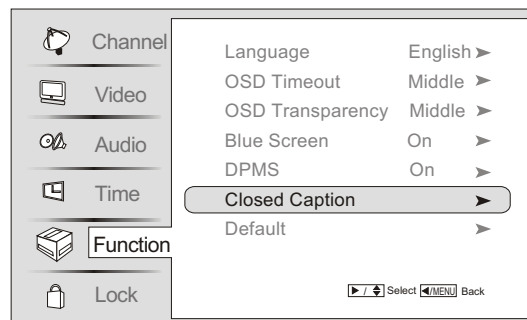
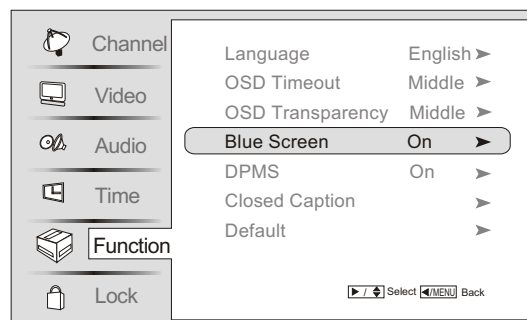
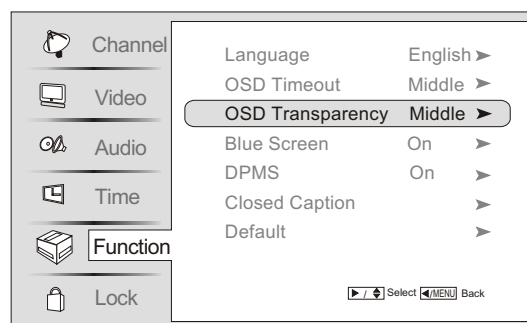
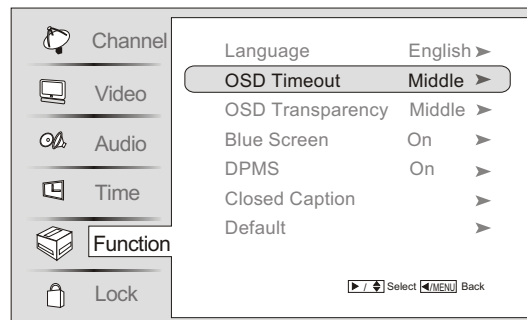

Function menu

■ Style

Select this option to select the font style of caption display according to your own preference.

Press the ◀/▶ button to select **Default** or **Custom**.

■ Size

Select this option to select the size of caption display according to your own preference.

Press the ◀/▶ button to select **Small**, **Normal** or **Large**.

■ Text color

Select this option to select the text color or the opacity of the text box of caption display according to your own preference. Select a color and one of the opacity options.

■ Text Opacity

Specify the opacity for the text color.

■ BG Color

Select a background color.

■ BG Opacity

Select the opacity for the background color.

■ Window Color

Select a window color.

■ Window Opacity

Select the opacity for the window color.

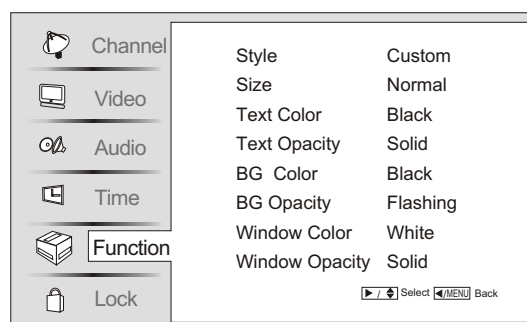
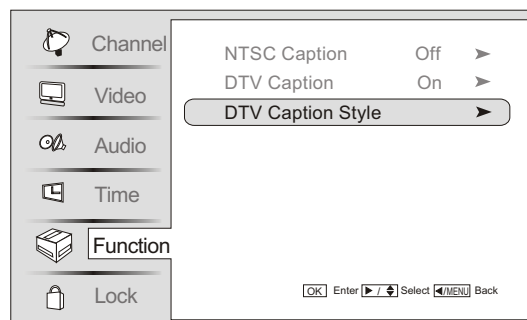

Adjust menu

Screen Setup for PC mode

When you select the PC input, this function is used.

Adjustment for screen Position, Clock, Phase, Setting

Display Adjust menu by pressing **INPUT** button then use ▲/▼

button to select the the source of PC item.

■ Auto sync: Automatically adjust display of the picture(

Only available in PC source).

■ Position : Adjust the screen position.

■ Phase : Adjust the phase of Pixel clock.

■ Clock : Adjust the clock of input signal.

1 Press the **MENU** button and then use ▲/▼ button to select the **Adjust** menu.

2 Press the ▶ or **OK** button and then use ▲/▼ button to select the desired items.

3 Press the ▶ button to adjust the setting.

4 When you are satisfied with your choice, press **MENU** button to return to the previous menu or press the **EXIT** button to return to TV viewing.

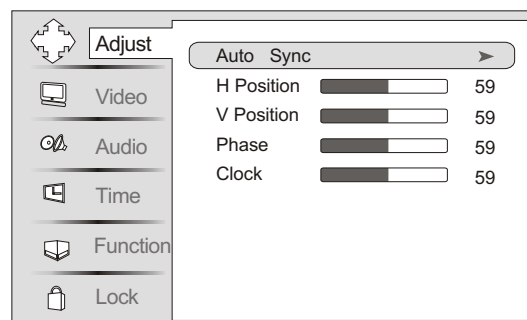

Lock Menu

Parental Control can be used to block specific channels, ratings and other viewing sources.

The Parental Control Function is used to block program viewing based on the ratings sent by the broadcasting station.

The default setting is to allow all programs to be viewed. Viewing can be blocked by choosing the type of the program and the categories.

To use this function, the following must be done :

1. Set ratings and categories to be blocked.
2. Specify a password
3. Enable the lock

Parental Control rating and categories

Rating guidelines are provided by broadcasting stations. Most television programs and television movies can be blocked by TV Rating and/or Individual Categories. Movies that have been shown at the theaters or direct-to-video movies use the Movie Rating System (MPAA) only.

Ratings for Movies previously shown in theaters:

Movie Ratings :

- G (General audience)
- PG (Parental guidance suggested)
- PG-13 (Parents strongly cautioned)
- R (Restricted)
- NC-17 (No one 17 and under admitted)
- X (Adult only)

If you set PG-13 : G and PG movies will be available , PG-13, R, NC-17 and X will be blocked.

Ratings for Television programs including made-for-TV movies :

- TV-Y (All children)
- TV-Y7 (Children 7 years older)
- TV-G (General audience)
- TV-PG (Parental guidance suggested)
- TV-14 (Parents strongly cautioned)
- TV-MA (Mature audience only)

TV Rating Children:

- ALL (Age) (applies to TV-Y, TV-Y7)
- FV (Fantasy Violence) (applies to TV-Y7)

TV Rating General:

- ALL (Age) (applies to TV-G, TV-PG, TV-14, TV-MA)
- D (Dialogue - sexual dialogue) (applies to TV-PG, TV-14)
- L (Language - adult language) (applies to TV-PG, TV-14, TV-MA)
- S (Sex - sexual situations) (applies to TV-PG, TV-14, TV-MA)
- V (Violence) (applies to TV-PG, TV-14, TV-MA)

Lock Menu

Lock setup

Set up blocking schemes to block specific channels, ratings, and external viewing sources.

A password is required to gain access to this menu.

1. Press the **MENU** button and then use **▲/▼** button to select the **LOCK** menu. Then, press the **▶** button.

The TV is set up with the initial password “0-0-0-0” and security default password is 9-4-4-3.

2. Use the **▲/▼** button to select the desired items, and press the **▶** button to enter the next menu. Once the option is selected, change the settings to your preference.

Password

Change the password by inputting a new password twice.

Parental Lock

1. Press **▲/▼** button to select **Parental Lock** item.
2. Press the **▶** button to select **On** or **Off**.

Note

If the Parental Lock is setting as Off, the change of the Parental Guide, MPAA Rating, CA Eng Rating and CA Fren Rating will be no useful.



Parental Guide

Note

The Parental control will automatically block certain categories that are “more restrictive”. For example, if you block “TV-Y” category, then TV-Y7 will automatically be blocked. Similarly, if you block the TV-G category, then all the categories in the “young adult” group will be blocked (TV-Y, TV-Y7, TV-G, TV-PG, TV-14, and TV-MA). The sub-ratings (D, L, S, V, TV) work together similarly.



How to set the D, L, S, V and TV sub-ratings.

First, the **▲/▼** button select one of these Ratings: TV-Y, TV-Y7, TV-G, TV-PG, TV-14, or TV-MA, and press the **◀/▶** button.

A symbol “” will be displayed for each sub-rating. While “” is selected, press the **OK** button to go to a sub rating.

To select a different Rating, press the **▲/▼** buttons and then repeat the process.

Note

The V-chip will automatically block certain categories that are “More restrictive”. For example, if you block “” sub-rating in TV-PG, then the “” sub-ratings in TV-14 and TV-MA will automatically be blocked.

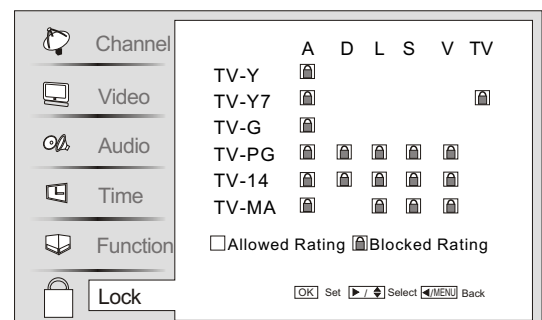
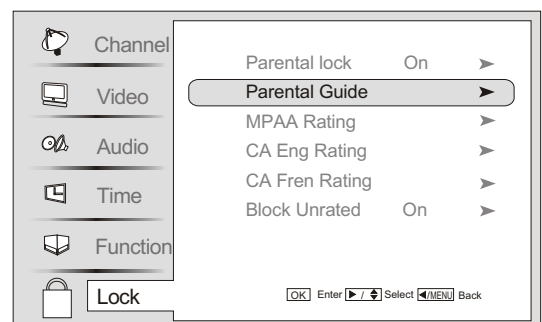
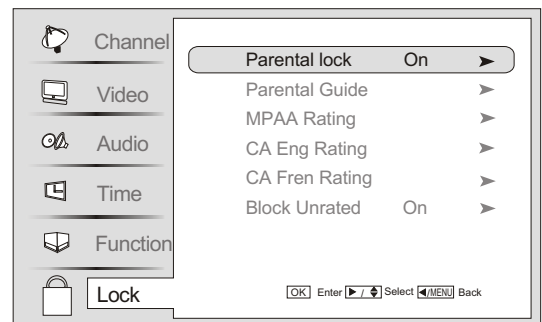
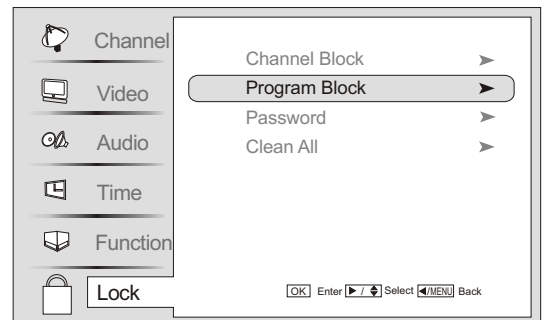
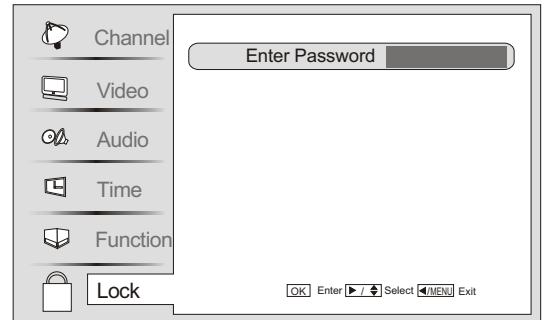

Lock Menu

MPAA Rating

Blocks movies according to the movie ratings limits specified, so children cannot view certain movies. You can set the ratings limit by blocking out all the movies with the ratings above a specified level. Keep in mind that the movie ratings limit only applies to movies shown on TV, not TV programs, such as soap operas.

- 1 Press **▲/▼** button to select **MPAA Rating** item.
- 2 Press the **▶** button and then use **▲/▼** button to select the rating.
- 3 Press the **OK** button to set block or unblock.
- 4 When you are satisfied with your choice, press **MENU** button to return to the previous menu or press the **EXIT** button to return to TV viewing.

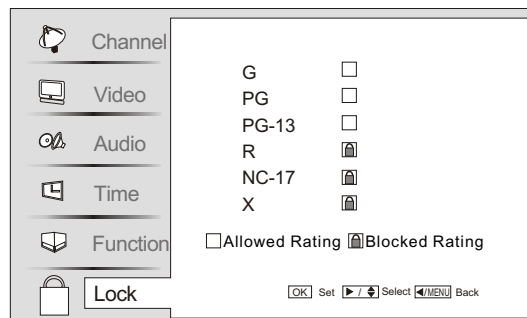

CA Eng Rating

Canadian English Language Rating

- 1 Press **▲/▼** button to select **CA Eng Rating** item.
- 2 Press the **▶** button and then use **▲/▼** button to select the rating.
- 3 Press the **OK** button to confirm.
- 4 When you are satisfied with your choice, press **MENU** button to return to the previous menu or press the **EXIT** button to return to TV viewing.

- C Children
- C8+ Children eight years and older
- G General Programming, suitable for all audiences
- PG Parental Guidance
- 14+ Viewers 14 years and older
- 18+ Adult Programming

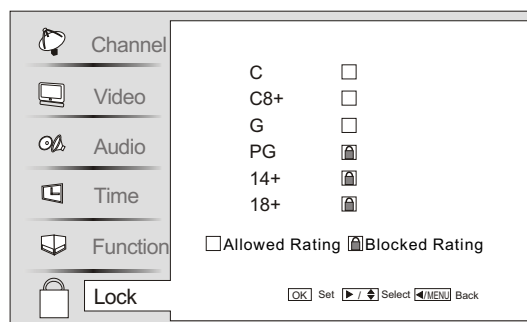

CA Fren Rating

Canadian French Language Rating

- 1 Press **▲/▼** button to select **CA Fren Rating** item.
- 2 Press the **▶** button and then use **▲/▼** button to select the rating.
- 3 Press the **OK** button to confirm.
- 4 When you are satisfied with your choice, press **MENU** button to return to the previous menu or press the **EXIT** button to return to TV viewing.

- G General
- 8 ans+ 8+ General - Not recommended for young children
- 13 ans+ Programming may not be suitable for children under the age of 13
- 16 ans+ Programming is not suitable for children under the age of 16
- 18 ans+ Programming restricted to adults

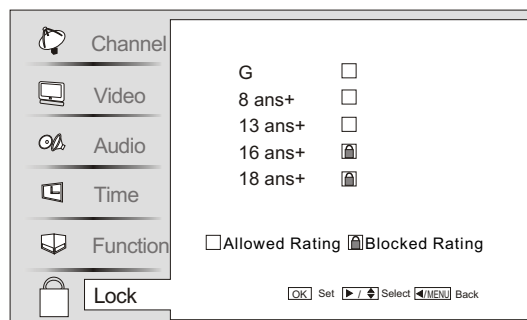

Other Functions

Brief Info

Brief Info shows the present screen information.
 Press the **INFO** button to show the Brief Info on the screen.
 Press the **INFO** button or **EXIT** button to exit.

Function:

- Show the present screen information.
- Press the **INFO** button or **EXIT** button to exit.

- A: Video resolution
- B: Program name
- C: Program rating categories
- D: program showtime
- E: Program title
- F: Channel name
- G: Tuner mode
- H: Program details

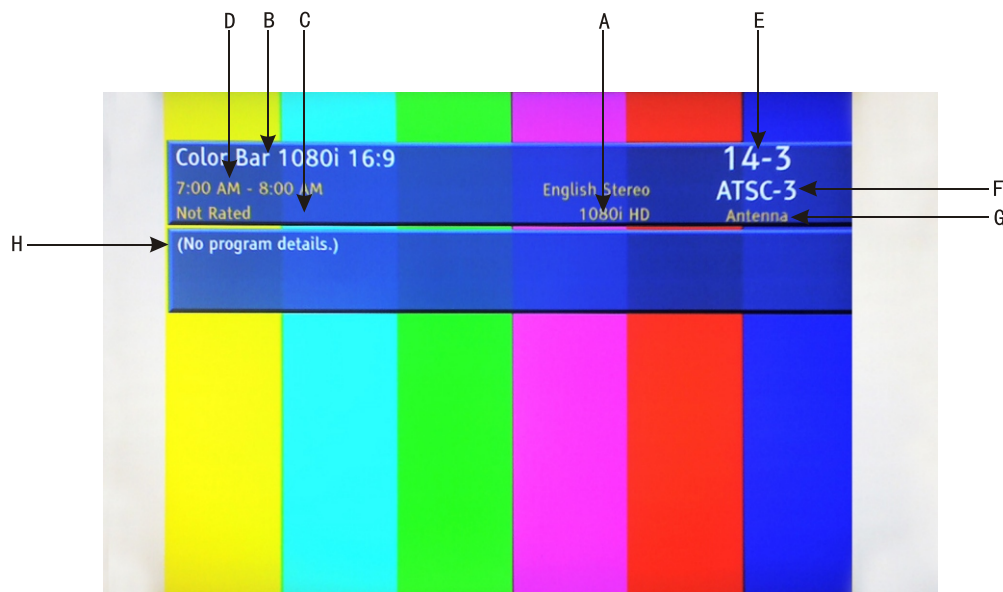

Quick program view

This function enables quick swap to the last watched program.

1 Suppose the channel number you used just now is 8 and the channel number you are using is 18 (as shown in the figure).

2 If you want to return to the last watched program channel 8, you can simply press the Q.VIEW button.

3 If you want to return to channel 18, press the button again. Use this function, you can easily change between the channel you are using and the channel you used last time.

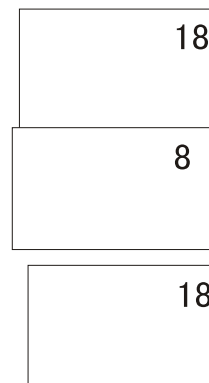

Other Functions

Aspect Ratio Control

Lets you choose the way an analog picture with a 4:3 aspect ratio is displayed on your TV with a 16:9 ratio picture format.

Note

If a fixed image is displayed on the screen for a long time, the image may become permanently burned on the screen and remain visible.

Press the **ARC** button to select the desired picture format (**Normal, Letterbox, Zoom, Dot by Dot, Auto**).

■ Normal

Choose normal when you want to view the picture with original aspect ratio of the input signal.

■ Letterbox

Choose Letterbox when you want to view the picture with an original aspect ratio, with gray bars appearing at both the left and right sides.

■ Zoom

Choose Zoom when you want to view the picture without any alteration. However, the top and bottom portions of the picture will be cropped.

■ Dot by Dot

choose **Dot by Dot** when you want to view the picture by the signal averaging.

■ Auto

Choose **Auto** when you want to the picture view by signal picture's averaging

CC (Closed Caption Display)

Closed Captions

Closed captioning is a process which converts the audio portion of a television program into written words which then appear as subtitles on the television screen. Closed captions allow viewers to read the dialogue and narration of television programs.

Using Closed Captions

Captions are the subtitles of the dialogue and narration of television programs. For prerecorded programs, program dialogue can be arranged into captions in advance. Its possible to caption a live program by using a process called real-time captioning, which creates captions instantly. Real-time captioning is normally done by professional reporters using a machine shorthand system and computer for translation into English. Captioning is an effective system for the hearing-impaired, and it can also aid in teaching language skills.

In ATV mode CCD function allows you to configure the way you choose to view the digital captioning (CC1, CC2, CC3, CC4, Text1, Text2, Text3 or Text4).

■ CAPTION

The term for the words that scroll across the bottom of the TV screen; usually the audio portion of the program provided for the hearing impaired.

■ TEXT

The term for the words that appear in a large black frame and almost cover the entire screen; usually messages provided by the broadcaster.

In DTV mode allows you to configure the way you choose to view the digital captioning (Off, service1, service2, service3, service4, service5 or service6).

Select one of the digital service channels made available by the caption provider.

There are 6 standard services. Service 1 is designated as the Primary Caption Service. This service contains the verbatim, or near-verbatim captions for the primary language being spoken in the accompanying program audio. Service 2 is designated as the Secondary Language Service. This service contains captions in a secondary language which are translations of the captions in the primary Caption Service. The other service subchannels are not pre-assigned. It is up to the discretion of the individual caption provider to utilize the remaining service channels.

Note

The captions do not always use correct spelling and grammar. Not all TV programs and product commercials are made for broadcast with Closed Caption information included. Refer to your area's TV program listings for the TV channels and times of Closed Caption shows. The captioned programs are usually noted in the TV listings with service marks such as "CC".

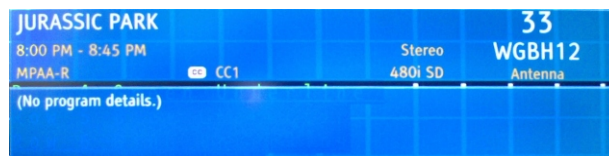

Remote Control

Setting Up Your Remote Control

After it has been setup properly, your remote control can operate in six different modes: TV, DVD, VCR, SETBOX, CABLE or AUDIO. Pressing the corresponding button on the remote control allows you to switch between these modes, and control whichever piece of equipment you choose.

Note

The remote control might not be compatible with all DVD Players, VCRs and Cable boxes.

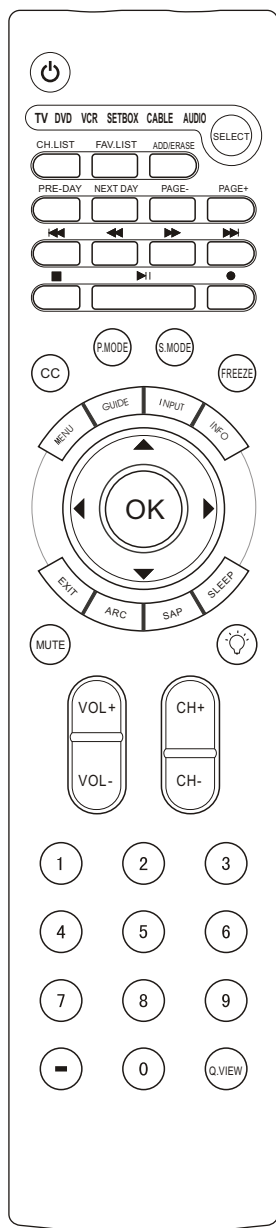

Control Operation

To control a device using the Control

1. Program the Control to work with your device.
2. Changing device mode by pressing the **SELECT** key. Default device is TV. When press **SELECT** key, current device led will be on. Keep pressing **SELECT** key to choose a device, the loop is: TV DVD VCR STB Cable Audio - TV. When device is set, related device LED will be on for 5 seconds and then be off.
3. Aim the remote at the device.
4. Press the **POWER** button to turn the device on.
5. Use the other Control buttons to operate the device. Device LED will blink if user presses any key (if the key has data in current mode.). If the key has no data, then LED will not blink.
6. Default init status: TV/Haier 001 code.
7. Bulb key to control the flash light.

Programming the Control

The Control is factory-programmed to support up to 600 code sets.

There are two ways to program the Control:

- ◆ Selecting a brand code for the device you wish to operate, and then entering that code manually into the Control.
- ◆ Using the PowerScan feature to find device codes automatically.

The two programming methods are described in the following sections.

Manually Programming the Control

1. Using **SELECT** key to choose the device you want to program.
2. While Press and holding **OK** key, press **SELECT** key, and device LED will be ON. Keep the status for about 5 seconds, release both keys and then LED will blink twice per second, indicating that the control is ready for programming.
3. Led will blink once when you enter a digit key, indicating the digit key is programmed. If 3 digits are programmed successfully, device LED will be ON for about 3 seconds and then blink twice per second. Then User now can:
 - a) Try to operate the device by using **POWER** or **PLAY** keys. If operation can be done, press **OK** to save current 3-digits code and exiting manually programming mode.
 - b) Return to beginning of step 3. Reprogram the control.
5. If user's input is incorrect, LED will blink 12 times in 3 seconds. And then kept twice per second blink, user now can return to step 3 and re-program the device.
6. Within 10 seconds, user should enter the 3-digit brand code corresponding to your device. If time out or any key other than **POWER**, **PLAY** and digits is pressed, LED will be off and manually programming process is exit.
7. Fast Programming Haier default TV code set. Press and holding the **EXIT** key and then press **SELECT** key for 5 seconds, default Haier code set (001) will be programmed to the control.

Manually scan mode

With manually scan programming, the control tests all the codes available in the code set data base and assign the correct one for the selected device.

To manually-scan program the control:

1. Manually turn OFF the device for manually scan mode. (TV, DVD, VCR, STB, cable box or audio equipment).
2. Press **SELECT** key to choose the device you wish to program. While Press and holding **OK** key, press the **SELECT** key and device LED will be ON. Keep the status for about 5 seconds, release both keys and then LED will blink twice per second, indicating that the control is ready for programming.
3. Press and release the **CH+/CH-** key. The LED blinks 10 times per seconds, indicating that the Remote is in manually scan mode.
4. Press **CH+/CH-** key repeatedly until the device switches ON (**CH+** key conducts a upward search while the **CH-** key conducts a downward search in the code set database).

Remote Control

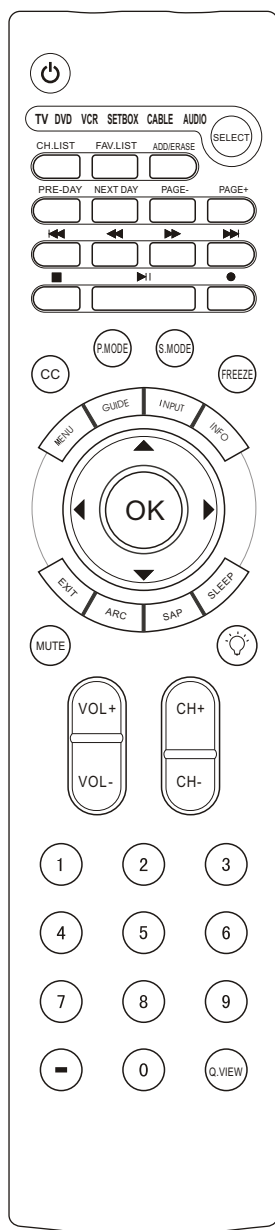

- When the device turns ON, press and release the **OK** key to program the control with the new code, saving the code and exit. To exit without programming, press any key other except **CH+/CH-** and **OK**. LED will be off after manually scan mode is exit.
- If the device responds, no further programming is required. If the device does not respond, repeat step 1 through 5. And searching will start from current code set. If no key was pressed in 30 seconds, manually scan mode will be automatically exit.
- After searching the entire data base, this mode will be automatically exited and led will blink for 3 times.

Automatic Scan Programming the Control

To automatic scan program the Control:

- Manually turn OFF the device you wish to power scan. (TV, DVD, VCR, STB, cable box or audio equipment).
- Press **SELECT** key to choose the device you wish to program.
While Press and holding **OK** key, press the **SELECT** key and device LED will be ON. Keep the status for about 5 seconds, release both keys and then LED will blink twice per second, indicating that the Control is ready for programming.
- Press and release the **Mute** key to enter automatic scan mode. And the remote will automatically sending power codes to the device.
- When the device turns ON, press **OK** key to program the control with the new code, saving it and exit. To exit without programming, press any key other except **OK** key.
- If the device responds, no further programming is required. If the device does not respond, repeat steps 1 through 4. And search will start from current code set.
- After searching the entire data base, this mode will be automatically exited and led will blink for 3 times.

Punch-Through Features

The Control provides two punch-through features that allow users to control TV volume and DVD or VCR operation while the control is in another device mode control certain features of another device.

Volume Punch-Through:

The TV Volume/Mute punch-through feature allows you to control the volume and mute function of your TV while the control is in another device mode. The feature is applicable for all devices and brands that do not use the volume control buttons for other purposes.

Transport Key Punch-Through:

The DVD or VCR transport key punch through feature lets you control the PLAY, STOP, PAUSE, REWIND, FF and RECORD functions of your DVD or VCR while the control operates in other modes. The feature is applicable for all devices and brands that do not use the transport keys for other purposes.

Protection mode

- While press and holding **OK**, press **AUTO** key for 5 seconds to enter protection mode. In this mode, all the above programming methods will be invalid.
- To exit protection: While press and holding **OK**, press **AUTO** key. Current device related LED remains ON and then release **OK** and **AUTO**. Input three digit password **888**, LED turns off and protection mode is ended. If error password is input or no password input in 10 seconds, LED blinks three times and then turns off. Protection mode will remain.

Display mode

- To enter display mode, while press and holding **OK** key, press the **SELECT** key and device LED will be ON, keep the status for about 5 seconds. Release both keys and then LED will blink 2 times per second, indicating control is ready for programming.
- Sequence press **9, 8, 0** to enter display mode. And LED is off now.
- Press digit **1** key to get the first digit of current code set. For example, if the first digit of code set is 1, so then led will blink once and remains OFF. Digit 0 in code set will not be displayed. Blink twice per second.
- Press digit **2** key to get the second digit of current code set. For example, if the second digit of code set is 3, so then led will blink three times and remains OFF. Blink twice per second.
- Press digit **3** key to get the third digit of current code set. Blink twice per second.
- Only digit **1, 2, 3** are valid in this mode. And the sequence is not fixed. You can repeat, if you don't remember clearly.
- Control will not send out data in this mode if user presses any keys other than digit **1, 2, 3**. And this can be regarded as no key pressed.
- If no key was pressed in 10 seconds or any key other than digit **1, 2, 3** is pressed, display mode is ended.

Remote Control

Remote Control Codes

TV

NO.	Brand	Code
1	Haier	001 002 003 004 005 006 007 008 009 010 011 085
2	A Mark	134
3	Action	108
4	Admiral	071 093 099 118 127 130 131
5	Advent	147
6	Aiko	079
7	Aiwa	047
8	Akai	104 105 123
9	Amtron	082
10	Anam	106
11	Anam National	072 082 110
12	AOC	073 074 075 104 112 117 134 140
13	Apex	000 157 015 016
14	Audiovox	082 108 140 144
15	Bell & Howell	071 084 118 131
16	Benq	051
17	Broksonic	037 038 104 106 118 138 146
18	Carver	153
19	CCE	118
20	Centurion	077
21	Citek	143
22	Citizen	073 075 079 082 089 092 138
23	Classic	104 123
24	Colortyme	073 075 105 116 118 125 127 139
25	Contec Cony	106 108
26	Contec/Cony	078 082
27	Craig	082 106 108 114 119 125 138
28	Crosley	118 153
29	Crown	082 087 119 134
30	CTX	056
31	Curtis	104
32	Curtis Mathes	070 073 075 084 089 092 102 105 112 117 118 125 127 134 135 148 153 155
33	Daewoo	073 074 075 079 092 104 110 112 117 134 135 140 144
34	Daytron	073 075 092 114 117 134 140
35	Denon	145
36	Dimensia	070 155
37	Dumont	073 091
38	Electrohome	072 073 075 080 104 105 117 134
39	Emerson	073 075 078 081 082 083 084 092 096 103 104 105 106 108 114 117 119 125 129 130 131 134 139 144 146
40	Envision	073 075 105 112
41	Fisher	052 084 115 123 124 133
42	Fujitsu	083
43	Funai	082 083 106 108
44	GE	165 066 067 070 072 073 075 168 086 104 106 110 113 116 117 125 126 127 128 134 144 149 154 155
45	Goldstar	073 074 075 078 080 092 104 105 109 112 117 134 135 137
46	Gradiente	105 122 123
47	Granada	134
48	Grundig	126 134
49	Hallmark	073 075 104
50	Harman Kardon	104
51	Hisense	151
52	Hitachi	041 042 058 059 068 073 075 078 101 117 126 127 131 134 140 145
53	Infinity	087 153
54	Janeil	094
55	JBL	087 153
56	JC Penney	070 073 074 075 168 086 089 092 104 112 113 125 126 127 134 149 155
57	Jensen	073 075 105 129
58	JVC	163 166 012 031 036 078 086 103 122 125 126
59	Kawasho	073 075 112 123
60	Kenwood	073 075 080 104 105 112 116 139
61	Kloss Novabeam	082 094 110
62	KTV	082 092 106 108 112 117 134
63	LG	074
64	Lloyds	137 139
65	Loewe	087
66	Logik	071 142
67	Luxman	073 075
68	LXI	070 075 084 087 104 118 127 149 153 155
69	Magnasonic	104 105 131 140
70	Magnavox	017 073 075 080 087 104 105 112 114 117 118 119 126 131 153
71	Majestic	071
72	Marantz	073 075 087 105 112 116 117 118 153
73	Megatron	075

NO.	Brand	Code
74	Memorex	071 074 075 084 104
75	MGA	073 074 075 080 105
76	Mitsubishi	049 073 074 075 080 104 105 112 117 134
77	Montgomery Ward	071
78	Motorola	072 093
79	MTC	073 074 075 089 104 112 118 125 140
80	Multitech	082
81	Multivision	088
82	NAD	075 101
83	NEC	072 073 074 075 105 112 116 117 139
84	Nikko	075 079 140
85	Noblex	137
86	Onwa	082 106
87	Optimus	101
88	Optonica	093
89	Orion	096 130 146
90	Panasonic	159 167 023 032 033 034 072 086 087 108 110 113 126 127 128 140
91	Philco	072 073 074 075 078 080 087 104 105 112 114 117 118 119 131 140 145 153
92	Philips	160 161 029 030 072 073 078 080 087 118 153
93	Pioneer	045 073 075 101 110 111 116 117
94	Portland	073 074 075 079 092 104 112 117 134 135
95	Price Club	089
96	Prima	135 142 152
97	Prism	086
98	Proscan	070 127 149 154 155
99	Proton	073 075 078 104 105 117 119 127 134 138
100	Quasar	053 063 064 072 086 110 114 126 128
101	Radio Shack	084 106 108 110 118 120 124 127 132 134 155
102	Radio Shack/Realistic	070 073 075 078 082 084 092
103	RCA	164 060 065 070 072 073 074 075 080 102 106 110 111 113 116 117 125 127 128 134 148 149 154 155
104	Realistic	084 155
105	Runco	091
106	Sampo	039 073 075 092 110 112 117
107	Samsung	043 048 054 057 062 073 074 075 078 080 089 092 097 104 112 117 118 125 131 134 139
108	Sansui	022 096 120
109	Sanyo	073 084 115 124
110	Scott	073 075 078 082 083 106 108 117 130 134
111	Sears	070 073 075 080 083 084 095 104 106 115 118 124 127 133 134 149 153 155
112	Sharp	013 028 035 073 075 078 092 093 120 131 132 134 139 141
113	Signature	071
114	Signature 2000	115 132
115	Sony	158 018 026 098 100 121 123 134
116	Soundesign	073 075 082 083 104 106 117 119 129
117	Starlite	082
118	Supre-Macy	094
119	Sylvania	044 046 069 073 075 080 087 104 105 112 114 117 118 119 140 153
120	Symphonic	081 082 095 108
121	Tandy	093 118
122	Tatung	072 110 138
123	Technics	086 126 128
124	Techwood	073 075 086 105 118
125	Teknika	071 073 074 075 078 079 082 083 089 092 106 108 112 116 117 119 134 137 140 143 153
126	Telecaption	090
127	Telefunken	139
128	Toshiba	162 019 021 024 025 027 084 089 090 115 125 133 150
129	Totevision	092 127
130	Ultra	140
131	Uniden	121
132	Universal	168
133	Video Concepts	106
134	Vidikron	118 153
135	Wards	070 071 073 074 075 080 081 083 168 087 104 112 113 117 118 119 120 125 127 131 153 155
136	Wallmart	055 051 107
137	White Westinghouse	104 112 134 135 140 144
138	Yamaha	073 074 075 080 112 119 139 140
139	Zenith	050 055 061 071 073 091 109 121 140
140	RePlay	156

Remote Control

Remote Control Codes

DVD

NO.	Brand	Code
1	Aiwa	073 044
2	Apex	000 001 003 004 016 028 029 030
3	Audiovox	074
4	Blaupunkt	078
5	BOSE	062 071
6	Broksonic	045
7	Clarion	046
8	Classic	047
9	Daewoo	079 080
10	Denon	075 095 096
11	Emerson	048 049
12	Fisher	050 076
13	Funai	049 064
14	GE	005 051 102
15	Go Video	068 070
16	GPX	052
17	Harman Kardon	066
18	Hitachi	065 067
19	Irradio	092
20	JVC	007 010 011 012 013
21	Kenwood	097 100
22	Koss	093
23	Magnavox	020 035
24	Marantz	085
25	Memorex	087
26	Mintek	053
27	Mitsubishi	088 089 090 091
28	NAD	048 081
29	Nakamichi	054
30	Norcent	055 056
31	Onkyo	082 086
32	Oritron	057
33	Panasonic	008 036 037
34	Philips	002 009 021 022 023 043
35	Pioneer	027 032
36	Proscan	005 099
37	Qwestar	057
38	RCA	005 024 038
39	Sampo	058
40	Samsung	006 017 033 041
41	Sansui	060
42	Sanyo	059 063
43	Sharp	014 031
44	Sherwood	061
45	Sony	015 018 034 039
46	Sylvania	049 072 077
47	Techwood	083
48	Toshiba	019 026 040 042
49	Yamaha	084 098
50	Zenith	069 094

VCR

NO.	Brand	Code	1	2	3	4	5	6	7	8	9	10	11	12
1	Admiral	073 074	101											
2	Aiko	056												
3	Aiwa	055												
4	Akai	044 045 068 069 080 093												
5	Audiovox	051												
6	Bell & Howell	048												
7	Broksonic	023 049 106												
8	Calix	051												
9	Canon	053 054												
10	Capehart	067 083												
11	Carver	060 110												
12	CCE	056 059												
13	Citizen	050 051 052 056 095												
14	Colorlyme	046 096												
15	Craig	050 051 059 085 090 105												
16	Curtis Mathes	043 046 050 053 054 077 079 112												
17	Daewoo	014 052 055 056 067 083 102												
18	Daytron	067 083 102												
19	Denon	088												
20	Dimensia	043 112												
21	Electrohome	051 090												
22	Emerson	044 049 051 052 053 055 061 069 087 090 106												
23	Fisher	048 089 105												
24	Fuji	045 053												
25	Funai	055 095												
26	Garrard	055												
27	GE	040 043 050 053 054 070 079 081 087 112												
28	Go Video	021 024 026 028 034 079 081 085 086												
29	Goldstar	046 051 079 090 092												
30	Gradiente	055 090												
31	Harman Kardon	046 110												
32	Harwood	059												
33	Hitachi	025 036 037 057 058 065 068 070 088												
34	JBL	098												
35	JC Penney	046 047 048 049 050 051 053 054 057 058 059 060 065 079												
		085 088 090												
36	Jensen	057 058 068												
37	JVC	000 019 046 047 048 068 071 087 088												
38	Kenwood	046 047 048 068 071 077												
39	KLH	059												
40	Kodak	051 053												
41	LG	051												
42	Lloyds	077 095 105												
43	Logik	059 085												
44	LXI	051												
45	Magnasonic	085 090 102												
46	Magnavox	008 053 054 060 064 085 110												
47	Marantz	046 047 048 053 060 077 092 110												
48	Matsushita	053												
49	Memorex	033 048 050 051 053 055 064 073 074 088 090 091 097105												
50	MGA	061 069												
51	MGN	079												
52	Minolta	057 058 065 088												
53	Mitsubishi	003 005 006 057 058 061 069 071 090												
54	Montgomery Ward	073 074												
55	Motorola	053 073 074												
56	MTC	050 085												
57	Multitech	050 055 059												
58	NEC	046 047 048 068 071 077 092												
59	Nikko	051												
60	Noblex	050												
61	Olympus	053												
62	Optimus	051 073 074 090 094												
63	Optonica	062												
64	Orion	087 090 106												
65	Panasonic	002 004 009 020 053 054 066 085 090 105												
66	Pentax	057 058 065 070 077 088												
67	Philco	053 054 060 088 106												
68	Philips	017 018 053 042 060 062 110												
69	Pioneer	047 057 071 075 078 104												
70	Portland	067 083												
71	Proscan	043 112												
72	Precision	102												
73	Proton	085												
74	Quasar	053 054 090												
75	Radio Shack	051 062 074 090												

Remote Control

Remote Control Codes

NO.	Brand	Code
76	Radio Shack/Realistic	048 050 051 053 054 055 062 073
77	Radix	051
78	RCA	012 016 043 044 050 053 057 058 065 070 078 079 088 107 108 112
79	Realistic	048 050 051 052 053 054 055 062 073 074 079 090 094 097 105
80	Ricoh	072 076
81	Runco	064
82	Samsung	029 031 035 039 050 052 079 095
83	Sansui	047 068 071 085
84	Sanyo	022 048 050 089 097 105
85	Scott	049 052 061 090
86	Sears	048 051 053 057 058 065 077 088 089 090 097 105
87	Sharp	015 062 073 074 091 094 101
88	Shintom	045 058 059 085
89	Signature	073 074
90	Signature 2000	097 101
91	Singer	053 059 072 076 085
92	Sony	007 041 045 063 080 082 084 098 099
93	STS	053 065
94	Sylvania	030 032 053 054 055 060 061 110
95	Symphonic	055 077 095 105
96	Tandy	048
97	Tashiko	051
98	Tatung	068
99	Teac	055 068 107
100	Technics	053 066
101	Teknika	051 053 055 090
102	Toshiba	010 011 052 057 061 069 100 102 105 109
103	Totevision	050 051 090
104	Tivo	111
105	Unitec	095
106	Unitech	050
107	Vector Research	046 047 052 077
108	Video Concepts	046 047 052 069 077
109	Wards	050 051 052 053 055 057 058 059 062 065 073 074 079 090 091 094 105 108 110
110	White Westinghouse	095
111	XR-1000	053 055 059
112	Yamaha	046 047 048 068 077
113	Zenith	027 038 045 064 072 076 090 093
114	Action	102

SETBOX

NO.	Brand	Code
1	Alphastar	028
2	Chaparral	024
3	DIRECTV	001 039
4	DISH NETWORK	001 026 030
5	Drake	027
6	Echostar	026
7	Express Vu	030
8	Fujitsu	022
9	GE	004 032 033
10	General Instruments	018 019
11	Hitachi	023
12	Hughes	023 036
13	Janeil	022
14	JVC	015
15	Mitsubishi	002 040
16	Panasonic	005 011
17	Philips	000 012
18	Proscan	032 033
19	Radio Shack	018 019
20	RCA	010 032 033
21	Realistic	014
22	Samsung	006 028
23	Sony	007 034 035 037 038
24	Star Choice	031
25	Star Trak	021
26	STS	020
27	Toshiba	008 029
28	Uniden	016 017
29	Zenith	009 013 022

CABLE

NO.	Brand	Code
1	ABC	000 001 002 030
2	Archer	006 007
3	Cableview	003
4	Contec	034
5	Eastern	035
6	GE	000
7	Gemini	012 013
8	General Instruments	000 032
9	Hamlin	036 037 038 040 044
10	Hitachi	000
11	Jerrold	000 012 015 016 026 030 032
12	Magnavox	017
13	Motorola	031
14	Movie Time	039
15	NEC	033
16	NSC	039
17	Oak	034 041
18	Panasonic	027 029
19	Philips	008 009 010 011 013 017 018 019 020
20	Pioneer	021 022
21	Proscan	000
22	RCA	003 029 032
23	Realistic	006
24	Samsung	022
25	Scientific Atlanta	002 023 024 025
26	Signature	000
27	Sprucer	029
28	Standard Component	042 043
29	Starcom	012 030
30	Stargate	012
31	Tocom	001 015
32	United Cable	030
33	Universal	004 006 007
34	View Star	017 034 039
35	Zenith	028

Remote Control

Remote Control Codes

AUDIO

Receiver/Tuner

NO.	Brand	Code
1	Aiwa	017 036 039
2	BOSE	010
3	Carver	051
4	Curtis Mathes	041
5	Denon	006 026 027 052
6	Fisher	042 044 049
7	Gradiente	062
8	Harman Kardon	008 038 046
9	Hitachi	059
10	JBL	038
11	Jensen	061
12	JVC	007 030
13	Kenwood	005 028 048 056
14	Luxman	064
15	Marantz	019
16	McIntosh	058
17	NAD	040
18	Nakamichi	054
19	NEC	040
20	Nikko	063
21	Onkyo	003 021 055
22	Optimus	041 047
23	Panasonic	009 012 016 029 050
24	Philips	014
25	Pioneer	004 023 041 045
26	Quasar	050
27	Radio Shack	047
28	RCA	071 072
29	Sansui	057
30	Sanyo	042 044
31	Sharp	060
32	Sherwood	047
33	Sony	000 024 043
34	Technics	002 020 050
35	Toshiba	025
36	Yamaha	048 053
37	Zenith	065

Audio Cassette

NO.	Brand	Code
1	Aiwa	039
2	Curtis Mathes	041
3	Denon	052
4	Fisher	042 049
5	GE	070
6	Kenwood	048 056
7	NAD	040
8	Nakamichi	054
9	Onkyo	055
10	Optimus	041 047
11	Panasonic	015 050
12	Philips	013
13	Pioneer	018 041 045
14	Proscan	070
15	Quasar	050
16	Radio Shack	047
17	RCA	070
18	Sansui	057
19	Sanyo	044
20	Sherwood	047
21	Sony	043
22	Technics	050
23	Yamaha	053

Audio System

NO.	Brand	Code
1	Aiwa	039
2	Carver	051
3	Curtis Mathes	041
4	Denon	052
5	Harman Kardon	046
6	Jerrold	066 068
7	Kenwood	048 056
8	Nakamichi	054
9	Panasonic	015 016
10	Philips	013 014
11	Pioneer	018 041
12	RCA & Dimensia	031 032 033 034 035
13	Sansui	057
14	Sanyo	044
15	Scientific Atlanta	067
16	Sony	043
17	Starcom	066
18	Technics	050
19	Yamaha	053

Amplifier

NO.	Brand	Code
1	Kenwood	048
2	Pioneer	041
3	RCA	069
4	Yamaha	001 053

Phono

NO.	Brand	Code
1	Kenwood	048
2	Pioneer	041
3	Sony	043
4	Yamaha	053

HTIB

NO.	Brand	Code
1	BOSE	010
2	Philips	022
3	Toshiba	025

Maintenance

Early malfunctions can be prevented. Careful and regular cleaning can extend the amount of time you will have your new TV. Be sure to turn the power off and unplug the power cord before you begin any cleaning.

Cleaning the Screen

1. Here's a great way to keep the dust off your screen for a while. Wet a soft cloth in a mixture of lukewarm water and a little fabric softener or dish washing detergent. Wring the cloth until it's almost dry, and then use it to wipe the screen.
2. Make sure the excess water is off the screen, and then let it air-dry before you turn on your TV.

Cleaning the Cabinet

To remove dirt or dust, wipe the cabinet with a soft, dry, lint-free cloth. Please be sure not to use a wet cloth.

Extended Absence

If you expect to leave your TV dormant for a long time (such as a vacation), it's a good idea to unplug the power cord to protect against possible damage from lightning or power surges.

Product Specification

Resolution	1366X768(Dot)
Power requirement	120V~ , 60Hz
Color system	NTSC, ATSC, Clear QAM
External Antenna Impedance	75 ohm
Color	16,770,000(256 steps of each R, G and B)
Operating Temperature Range	32~104°F(0~40°C)
Operating Humidity Range	Less than 80%
Maximum Elevation	6561 feet (2000m)

MODEL	Dimensen(WXDXH) Unit::inches/mm (Including stand)	Weight(pounds/kg)
HL37S®	43.1X11.2X27.0inches 1096X285X685 mm	55.1/25
HL37B®	37.2X12.2X28 inches 946X310X708 mm	50/22.5
HL42B®	42.0X12.2X31.5 inches 1068X310X800mm	66.6/30.2
HL37BG®	37.2X12.2X28 inches 946X310X708 mm	50/22.5
HL40BG®	39.9X12.2X29.1 inches 1014X310X740 mm	55/25.1
HL42BG®	42.0X12.2X31.5 inches 1068X310X800 mm	66.6/30.2

■ The specifications shown above may be changed without prior notice for quality improvement.

Troubleshooting

For the sake of time and cost, it is strongly recommended that you check out the problem by yourself according to the instructions listed hereunder before contacting the after-sales service for technical assistance.

No picture, no sound	Verify if the television is properly plugged. Verify if the television is properly supplied power. Verify if electricity is available.
Blank screen	Verify if correct signals are input. Press INPUT button to change signal input to TV input. Restart the television if power supply is interrupted.
No sound	Press Mute button and verify if Mute mode is set. Switch to other channel and verify if the same problem happens. Press VOL+ button to see if the problem can be solved.
Poor sound	Verify if sound system is correct. Refer to Page 22 for adjustments.
No picture in some channel	Verify if correct channel is selected. Adjust the antenna. Make adjustments by Fine Tune and Manual Scan.
No color for some channel program (black and white)	Verify if the same problem exists in other channels. Check out of picture and sound systems. Refer to relative instructions in the Manual for color adjust.
Spots with some or all pictures	Verify if the antenna is correctly connected. Verify if the antenna is in good condition. Make fine adjustment of channel.
Horizontal/vertical bars or picture shaking	Check for local interference such as an electrical appliance or power tool.
Television out of control	Disconnect the television from power supply and, 10 seconds later, connect the television to the power supply. If the problem still exists, contact authorized after-sales service for technical assistance.

Note: Do not leave the television with static picture in an extended period as the image may become permanently burned.

Note: Production of the LCD screen requires high and precision technologies. However, there might be some dark or bright (red, blue or green) spots, or some anomalistic stripes or spots. This is not defect. If the TV set is used in an area 2,400 meters above the sea level where the air pressure is below 750hpa, the picture on the LCD screen may be affected and a muffled sound might be produced. These phenomena might happen in the area 1,500 meters above the sea level. This is resulted from difference between air pressures inside and outside the display. This is not a defect covered by the limited warranty.

Warranty

This Haier brand product, when shipped in its original container, will be free from defective workmanship and materials, and agrees that it will, at its option, either repair the defect or replace the defective product with a new or re-manufactured equivalent at no charge to the purchaser, for parts or labor for the periods set forth below:

This warranty does not apply to the appearance of the product or the exterior of the product, which has been damaged or defaced, altered or modified in design or construction. It does not apply to the additional excluded items set forth below:

The warranty commences on the date the item was purchased and the original purchase receipt must be presented to the authorized service center before warranty repairs are rendered.

The limited warranty described herein is in addition to whatever implied warranties may be granted to purchasers by law. ALL IMPLIED WARRANTIES INCLUDING THE WARRANTIES OF MERCHANTABILITY AND FITNESS FOR USE ARE LIMITED TO THE PERIOD(S) FROM THE DATE OF PURCHASE SET FORTH BELOW. Some states do not allow limitations on how long an implied warranty lasts, so the above limitation may not apply to you.

Neither the sales personnel of the seller nor any other person is authorized to make any warranties other than those described herein, or to extend the duration of any warranties beyond the time period described herein on behalf of Haier.

The warranties described herein shall be the sole and exclusive warranties granted by Haier and shall be the sole and exclusive remedy available to the purchaser. Correction of defects in the manner and for the period of time described herein, shall constitute complete fulfillment of all abilities and

Responsibility of Haier to the purchaser with respect to the product, and shall

constitute full satisfaction of all claims, whether based on contract, negligence, strict liability or otherwise. In no event shall Haier be liable, or in any way responsible for any damages or defects in the product which were caused by repairs or attempted repairs performed by anyone other than an authorized service center or dealer; nor shall Haier be liable, or in any way responsible for incidental or consequential economic or property damage. Some states do not allow the exclusion of incidental or consequential damages, so that above exclusion may not apply to you.

THIS WARRANTY GIVES YOU SPECIFIC LEGAL RIGHTS. YOU MAY ALSO HAVE OTHER RIGHTS WHICH VARY FROM STATE TO STATE.

Warranty period for this product: one year parts and labor.

Additional items excluded from warranty coverage: non-rechargeable batteries.

Where to obtain service: For the location of the nearest Haier authorized service center or to obtain product literature, accessories, supplies or customer assistance, please call 1-877-337-3639.

What to do to obtain service: ship or carry in your product to an authorized service dealer or center. Be sure to have proof of purchase. If you ship the product, be sure it is packaged carefully.

Haier America
New York, NY 10018

Haier

01
0090501976

Free Manuals Download Website

<http://myh66.com>

<http://usermanuals.us>

<http://www.somanuals.com>

<http://www.4manuals.cc>

<http://www.manual-lib.com>

<http://www.404manual.com>

<http://www.luxmanual.com>

<http://aubethermostatmanual.com>

Golf course search by state

<http://golfingnear.com>

Email search by domain

<http://emailbydomain.com>

Auto manuals search

<http://auto.somanuals.com>

TV manuals search

<http://tv.somanuals.com>