

Haier®

HLA15/HLA19



LCD TV

USER MANUAL

Please read this manual carefully
before using this TV set and keep it
for future reference.

WARNING AND CAUTION



CAUTION

**RISK OF ELECTRIC SHOCK
DO NOT OPEN**



CAUTION:

TO REDUCE THE RISK OF ELECTRIC SHOCK, DO NOT REMOVE COVER (OR BACK). NO USER SERVICEABLE PARTS INSIDE. FOR ANY PROBLEM, REFER SERVICING TO QUALIFIED SERVICE PERSONNEL.

THERE IS A LIGHTNING ARROW SYMBOL IN THE TRIANGLE: THIS SYMBOL INDICATES HIGH VOLTAGE IS PRESENT INSIDE. IT IS DANGEROUS TO MAKE ANY KIND OF CONTACT WITH ANY INSIDE PART OF THIS PRODUCT.

THERE IS A EXCLAMATION MARK IN THE TRIANGLE: THIS SYMBOL ALERTS YOU THAT IMPORTANT LITERATURE CONCERNING. OPERATION AND MAINTENANCE HAS BEEN INCLUDED WITH THIS PRODUCT.



CAUTION:

TO REDUCE THE RISK OF ELECTRIC SHOCK AND FIRE, DO NOT PUT THE TV SET NEAR SOURCES OF HUMIDITY. DO NOT USE ANY ABRASIVE CLEANSERS WHICH MAY SCRATCH OR DAMAGE THE LCD SCREEN. AVOID CONTACT WITH OBJECTS THAT MAY SCRATCH THE LCD SCREEN.



NOTE: SERVICING THE UNIT YOURSELF IS UNAUTHORIZED AND COULD LEAD TO INJURY OR PRODUCT DAMAGE.

To users:

Thank you for purchasing our LCD-TV.

Before connecting the LCD-TV and turning on the power, please read this book carefully. Please keep this book for later use. If the unit is disabled by an electrostatic discharge, please turn off the power to the unit and turn it back on to reset.

CONTENT

Safety Notice Items.....	1
Front Panel Controls.....	2
Connection Options.....	3
Remote Control Key Functions.....	4
Remote Control	5
Installing Batteries.....	5
Connection Instructions.....	6
Grounding.....	6
External equipment Connections.....	6
Antenna Connection.....	6
PC Setup.....	7
VCR Setup.....	8
Cable TV Setup.....	9
External AV Source Setup.....	9
Basic Operating Instructions.....	10
Turn on the LCD-TV.....	10
Audio Control.....	10
Mute.....	10
Select the TV Channel You Want.....	11
Picture Mode.....	11
Program Scan.....	11
Sleep.....	11
Menu Operations.....	12
Picture Menu Options.....	12
Picture Menu Options Continued.....	13
Sound Menu Options.....	13
Sound Menu Options Continued.....	14
Function Menu Options.....	15
Function Menu Options Continued.....	16
Adjust Menu Options.....	16
Tuning Menu Options.....	17
Tuning Menu Options Continued.....	18
Parental Menu Options.....	18
Parental Menu Options Continued.....	19-21
Troubleshooting Guide.....	22
Specifications.....	23

Safety Notice Items

Incorrect usage may cause fire or electric shock. To prevent this, please do as required when you are installing, using and cleaning this machine. To ensure your safety and extend the life-span of LCD-TV, please read the following items carefully before using:

- Please read and understand all the instructions before operation;
- Please keep this manual for later use;
- Please comply strictly with the warning instructions on the machine and in this book;
- Please comply with the instructions provided;
- Please do not use additional devices that are not recommended by manufacturer:
- Before operation, please make sure that the operating voltage of your unit is correct;
- Do not place the unit on unstable, dusty and humid places;
- Never put the unit in direct sunlight or near heat sources;
- Allow enough space for proper ventilation;
- Please keep water away from the LCD-TV . If water comes in contact with the LCD-TV, disconnect the power cord from the power source, then wipe the set with a dry soft cloth;
- Do not remove the back cover. If service is needed, please contact an Authorized service technician.

Front Panel Controls

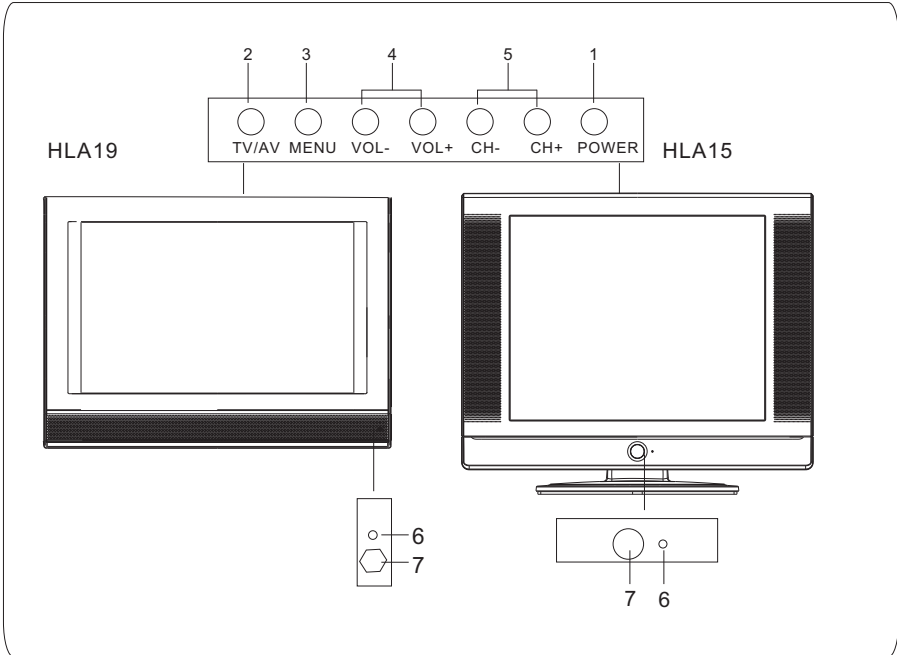

Control Panel Function

1. Power supply switch
2. TV/AV Selects the input signals: TV/AV/S-VIDEO/PC/COMPONENT
3. MENU Press to select the main menu
4. VOL- Volume down / Left orientation to adjust the item in the OSD
VOL+ Volume up / Right orientation to adjust the item/Press to enter
5. CH- TV channel down / to select the item in the menu
CH+ TV channel up / to select the item in the menu
6. Power indicator
Illuminates red in standby mode, illuminates green when the display is turned on
7. Remote Sensor Receives the signals from the remote control

Connection Options

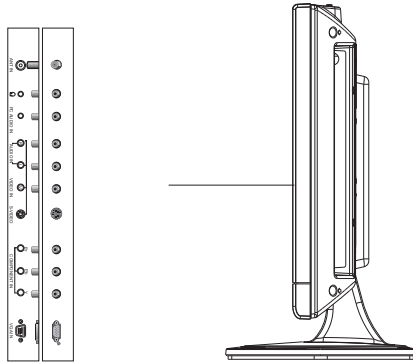

(The above figure is for reference only, connections may differ depending upon the models)

Antenna Input

Connect cable or antenna signals to the TV, either directly or through your cable box.

PC Audio Input

Connect the audio output from the pc to the audio input port

Video Input

Connect video output from an external device to this jack

VGA Input

Connect to the VGA 15PIN analog output connector of a PC display card to use set as a PC display

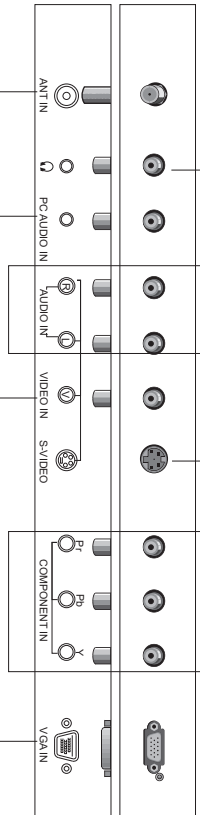

Earphone port

AV/S-VIDEO/ COMPONENT Audio Input

Connect audio output from an external device to these jacks

S-Video Input

Connect S-Video out from an S-Video device to the jacks.

DVD/DTV Input

Connect a component video/audiodevice to these jacks

Remote Control Key Functions

When using the remote control, aim it towards the remote sensor on the TV

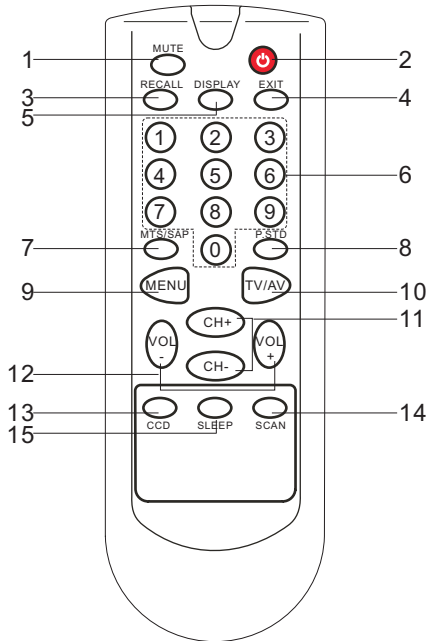



Illustration of the keys on the remote control:

1. MUTE	Press to mute the sound
2. 	Press to turn the TV on and off
3. RECALL	While in TV mode, press to return to the previous channel
4. EXIT	Press to turn off the on screen display
5. DISPLAY	Display current input signal information
6. 0-9	TV channel number select
7. MTS/SAP	Select MONO, STEREO, SAP in NTSC system
8. P.STD	Select picture mode: PERSONAL/STANDARD/MILD/FRESH
9. MENU	To display/exit the main menu
10. TV/AV	Select TV/AV/S-VIDEO/PC/ COMPONENT
11. CH+/CH-	TV channel up/down or select the item of the menu
12. VOL+	Volume up/ to select the main menu/to adjust the item/ to enter the submenu.
VOL-	Volume down/ to select the main menu/to adjust the item
13. CCD	Closed caption on/off
14. SCAN	Press to scan through memorized TV channels
15. SLEEP	Press to set the sleep timer

Remote Control

Installing Batteries

Remove the battery cover.

Insert two size AA batteries matching the +/- polarities of the battery to the +/- marks inside the battery compartment.

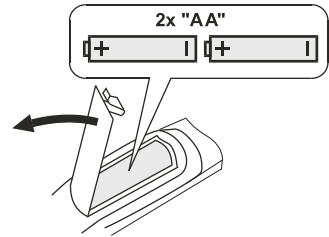

Precautions

Make sure that there is no obstacle between the remote controller and television set.

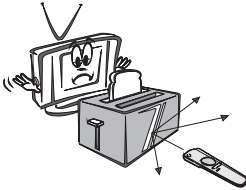

Keep the remote control away from heat sources or humid areas to ensure effective performance of the remote.

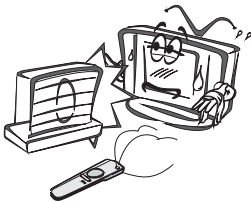

As strong light may interfere with the signals, change your position to operate the remote control if the television cannot be turned on or off as expected.



Make sure that two AA 1.5V alkaline batteries are loaded. The batteries must be of the same type, must be inserted properly, and must not be rechargeable.

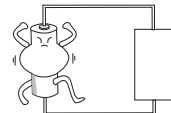

Connection Instructions

Grounding

Ensure that you connect the grounding / earth wire to prevent possible electric shock. If grounding methods are not possible, have a qualified electrician install a separate circuit breaker. Do not try to ground the unit by connecting it to telephone wires, lightning rods, or gas pipes.

External Equipment Connections

Antenna Connection

- Antenna or Cable Service with a Cable Box Connections
- For optimum picture quality, adjust antenna direction if needed.

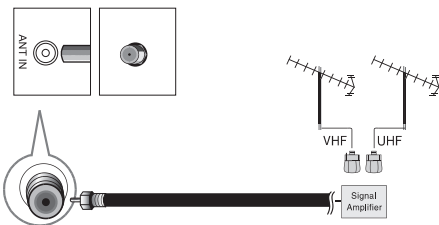
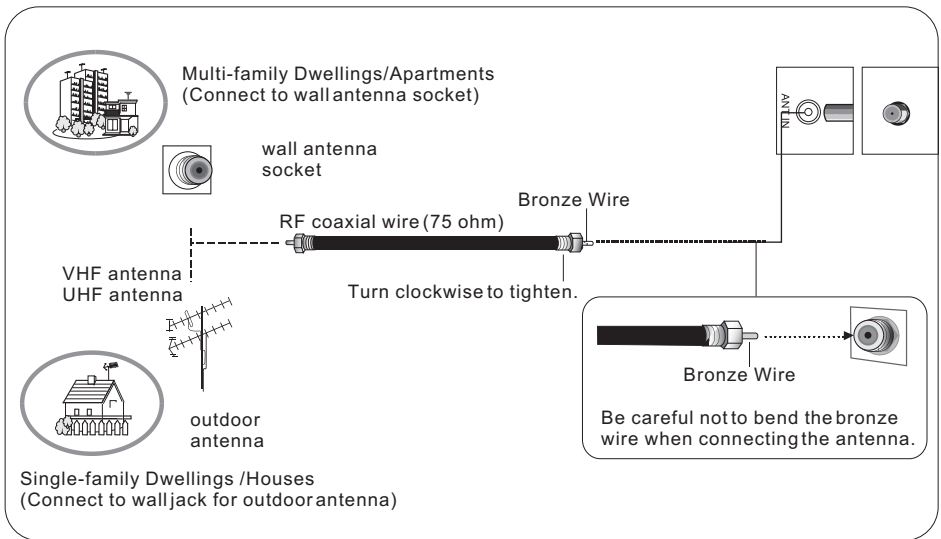

- To improve picture quality in a poor signal area, purchase and install a signal amplifier.
- If the antenna needs to be split for two TVs, install a "2-Way Signal Splitter" in the connections.
- If the antenna is not installed properly, contact your dealer for assistance.

NOTE: Cables shown are not included with the TV

Connection Instructions

PC Setup

You can use your LCD-TV as a monitor for your personal computer using a VGA cable (not supplied).

Connection and use steps:

1. Read the user guide supplied with your computer and ensure that it has a VGA connector;
2. Make sure that the power of the LCD-TV and the PC are off;
3. Connect a D type 15-pin VGA interface cable (not supplied) to the VGA video interface connector on the PC. Then connect the other end to the VGA video interface connector on the back of the LCD-TV. Tighten the screws on the VGA connectors once they are firmly connected;
4. Turn on the power of the LCD-TV first, and then turn on the power of the PC;
5. Press the INPUT button to set the video input mode of the LCD-TV to PC-RGB;
6. Check the image on your TV. There may be noise associated with the resolution, vertical pattern, contrast or brightness in PC mode. If noise is present, change the PC mode to another resolution, change the refresh rate to another rate or adjust the brightness and contrast on the menu until the picture is clear. If the refresh rate of the PC graphic card can not be changed, change the PC graphic card or consult the manufacturer of the PC graphic card.

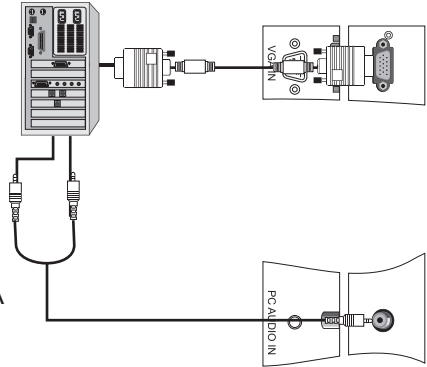

Connection Instructions

VCR Setup

- To avoid picture noise (interference), leave an adequate distance between the VCR and TV

Connection and use steps:

1. Read the user guide supplied with your AV devices and ensure that it has Composite or S-Video connectors;
2. Make sure that the power of the LCD-TV and the AV device are off;

Connection Option 1

Set VCR output switch to 3 or 4 and then tune TV to the same channel number.

Connection Option 2

1. Connect the audio and video cables from the VCR's output jacks to the TV input jacks, as shown in the figure.
When connecting the TV to VCR, match the jack colors (Video = yellow, Audio Left = white, and Audio Right = red).
If you connect an S-VIDEO output from VCR to the S-VIDEO input, the picture quality is improved; compared to connecting a regular VCR to the Video input.
2. Insert a video tape into the VCR and press PLAY on the VCR. (Refer to the VCR owner's manual.)
3. Turn on the power of the LCD-TV first; and then turn on the power of the AV device;
4. Press the TV/AV button to set the video input mode of the LCD-TV to S-VIDEO mode or AV mode.

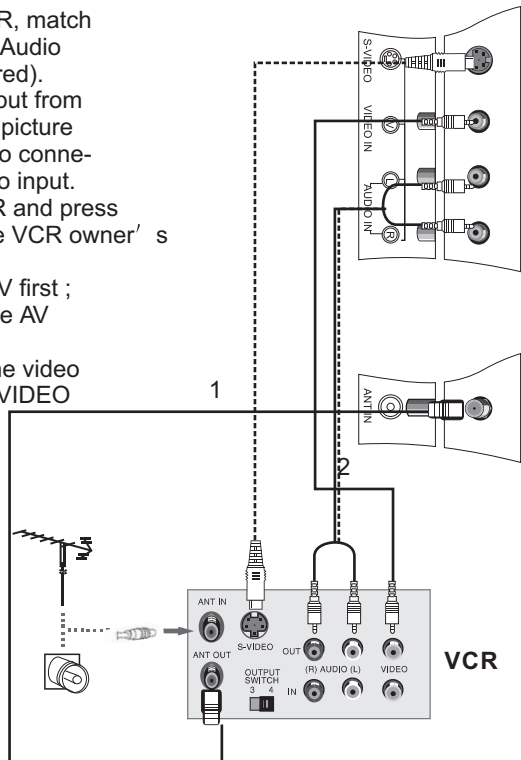

Connection Instructions

Cable TV Setup

- After subscribing to a cable TV service from a local provider you can watch cable TV programming. The TV cannot display TV programming unless a TV tuner device or cable TV converter box is connected to the TV.
- For further information regarding cable TV service, contact your local cable TV service provider(s).

Connection Option 1

1. Select 3 or 4 with channel switch on cable box.
2. Tune the TV channel to the same selected output channel on cable box.
3. Select channels at the cable box or with the cable box remote control.

Connection Option 2

1. Connect the audio and video cables from the Cable Box's output jacks to the TV input jacks, as shown in the figure. When connecting the TV to a Cable Box, match the jack colors (Video = yellow, Audio Left = white, and Audio Right = red).
2. Select the input source by using the TV/AV button on the remote control.
3. Select your desired channel with the remote control for cable box.

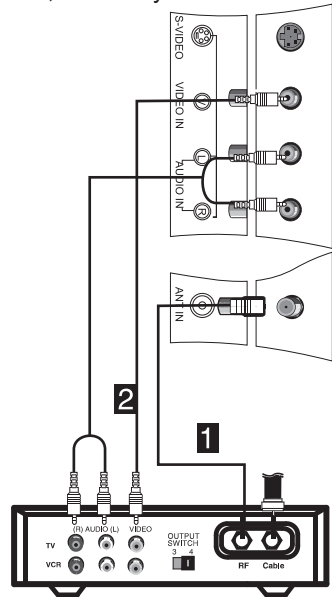

Cable Box

External AV Source Setup

How to connect

Connect the audio and video cables from the external equipment's output jacks to the TV input jacks, as shown in the figure. When connecting the TV to external equipment, match the jack colors (Video = yellow, Audio Left = white, and Audio Right = red).

How to use

1. Select the input source by using the TV/AV button on the remote control.
2. Operate the corresponding external equipment. Refer to external equipment operating guide.

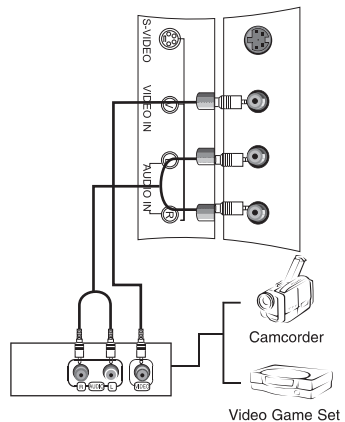

Basic Operating Instructions

Turn on the LCD-TV

When the **POWER** (⏻) button is pressed and the LCD-TV is turned on, the indicator light on the front of the LCD-TV changes from red to green. When the LCD-TV is turned off using the power button, the LCD-TV will go into standby mode and the indicator light turns red.

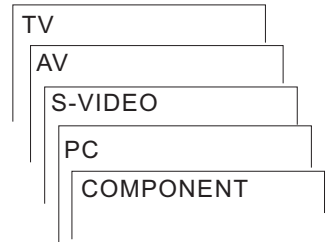

Each time you press the TV/AV button, TV, AV, S-VIDEO, PC, COMPONENT will appear on the screen in order.

Audio Control

1. Press the **VOL+** button to increase the volume. A number will appear on screen indicating the volume level.
2. Press the **VOL-** button to decrease the volume. A number will appear on screen indicating the volume level.

Mute

1. Press the **MUTE** button to mute the sound temporarily. A mute icon appears on the screen.
2. Press the **MUTE** button or **VOL+/VOL-** again to restore the sound. The mute icon disappears.

Basic Operating Instructions

Select the TV Channel You Want

You can use the number keys on the remote control to directly select TV channels.

The LCD-TV can store up to 181 channels , and you can press the keys on the remote control or on the panel to make a selection.

Picture Mode

Press **P.STD** button on the remote control for menu display . For desired mode as follows:

PERSONAL→ STANDARD→ MILD→FRESH

Program Scan

Press **SCAN** button to scan through all the memorized TV channels. The scan will pause for about 2 seconds on each channel .

If you want to stop the function during auto scanning, simply press the **SCAN** button again .

Sleep

Press **SLEEP** button to set the time : SLEEP 240 MIN-SLEEP 180 MIN-SLEEP 120 MIN -SLEEP 90 MIN-SLEEP 60 MIN-SLEEP 45 MIN-SLEEP 30 MIN-SLEEP 15 MIN-SLEEP 10 MIN-SLEEP 5 MIN-SLEEP 0 MIN

This feature allows you to turn off the television after a pre-selected number of minutes.

Menu Operations

* In this manual, the OSD (OnScreen Display) may differ from your TV
These are examples to illustrate the TV's operation.
Press TV/AV to select the input source. The menu for each source may be different .

1. Press **MENU** button to display the main menu, and **VOL+/VOL-** to select the main menu .
2. Press **CH+/CH-** to scroll through the parameters
3. Press **VOL+/VOL-** buttons to make changes to the parameters
4. Press the **EXIT** button to exit the menu

Picture Menu Options

Picture quality can be adjusted for any input separately .

The picture quality on the screen can be adjusted as follows:

1. Press **MENU** button and **VOL+/VOL-** until the following menu appears on the screen.
2. Press **CH+/CH-** button to enter the picture menu and to go up and down to select the desired option .

PC MENU

PICTURE	
BRIGHTNESS	30
CONTRAST	30
SHARPNESS	2
COLOR TEMP	COOL
 > 30	

COMPONENT MENU

PICTURE	
BRIGHTNESS	30
CONTRAST	30
SHARPNESS	2
COLOR	30
NOISE REDUCTION	MID
H POSITION	0
V POSITION	0
COLOR TEMP	NEUTRAL

TV/AV/S-VIDEO MENU

PICTURE	
BRIGHTNESS	50
CONTRAST	50
SHARPNESS	2
COLOR	50
NOISE REDUCTION	MID
COLOR TEMP	NEUTRAL
HUE	50

Only available in NTSC system

Note: Symbols on top of the menu in this manual may differ from the actual set display

Menu Operations

Picture Menu Options continued

3. Press **VOL+/VOL-** button to increase and decrease the level to adjust the selected option to your preference .
4. Repeat step 2 and step 3 until desired picture quality has been achieved .

Function:

BRIGHTNESS :Adjust the brightness of the picture . By increasing the level, it will lighten the dark parts of the picture and by decreasing the level it will darken the lighter parts of the picture.

CONTRAST :Adjust the contrast of the picture . The contrast becomes higher as the number increases.

SHARPNESS :Adjust the amount of the detail enhancement , the image sharpness rises as the number increases (By increasing the level, it will show cleaner and clearer images and by decreasing the level, it will make the picture smoother).

COLOR : Press **VOL+/VOL-** to adjust the color

HUE : Adjust the tone of the picture . This will appear and can be adjusted only in NTSC mode

COLOR TEMP: Press to select the color temperature from NEUTRAL/WARM/COOL

NOISE REDUCTION:Adjust the quality of the picture by selecting OFF,LOW,MID, HIGH.

H POSITION : Picture horizontal adjust

V POSITION : Picture vertical position adjust .

Sound Menu Options

Sound can be adjusted for any input as follows:

1. Press **MENU** and **VOL+/VOL-** button until the following menu appears on the screen

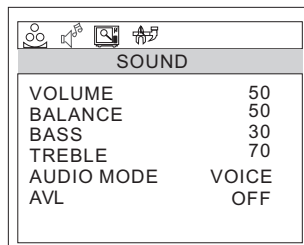

SOUND	
VOLUME	50
BALANCE	50
BASS	30
TREBLE	70
AUDIO MODE	VOICE
AVL	OFF

Menu Operations

Sound Menu Options continued

You can adjust sound options to the levels you prefer.

2. Press **CH+/CH-** button to enter the audio menu and to go up and down to select the desired option .
3. Press **VOL+/VOL-** button to increase and decrease the level to adjust the selected option to your preference .
4. Repeat step 2 and step 3 until desired sound quality has been achieved .

Function :

VOLUME : Adjust the volume of your TV

BALANCE : Adjust the balance of the audio output from left to right . When indication value of balance increases toward 100 , sound from the left speaker becomes weaker . When indication value of balance decreases toward 0 , sound from the right speaker become weaker .

BASS : Adjust the bass of the sound . Can only be adjusted under PERSONAL mode .

TREBLE : Adjust the treble of the sound . Can only be adjusted under PERSONAL mode .

AUDIO MODE : Press **VOL+/VOL-** to select among PERSONAL, VOICE, MUSIC and THEATRE .

AVL: Automatic Volume Limit Control reduces the effect of high volumes by limiting the same volume peaks across all channels .

Menu Operations

Function Menu Options

Menu Language Selection:

The OSD menus can be shown onscreen in the various languages. First select the system language.

1. Press **MENU** button and **VOL+/VOL-** until the following menu appears on the screen.

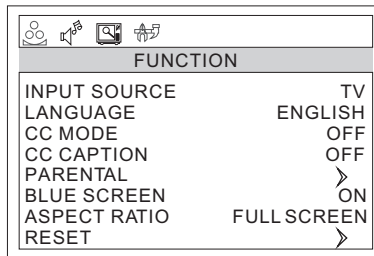

2. Press **CH+/CH-** button to enter the function menu and to go up and down to select the desired option .
3. Press **VOL+/VOL-** button to increase and decrease the level to adjust the selected option to your preference .
4. Repeat step 2 and step 3 until desired settings have been achieved .

Functions:

1. **INPUT SOURCE** : Display current mode . There are TV , AV ,S-VIDEO, PC, COMPONENT to display .
2. **LANGUAGE** : Press **VOL+/VOL-** to select the OSD language.
3. **CC MODE**: Press **VOL+/VOL-** to select among OFF, ON WHEN MUTE, ON.
OFF: Means the CC MODE is turned off.
ON WHEN MUTE: Means there will be CC CAPTION when the sound is mute.
ON: Means the CC MODE is turned on.
4. **CC CAPTION** : Press **VOL+/VOL-** buttons to select the Closed Caption options. Closed Captioning helps the hearing impaired with the broadcast program, as well as helping children learn how to read. A built in decoder displays the audio portion of a program as text on the screen when this option is selected.
OFF: When OFF is displayed on TV, it means CC CAPTION is turned off.
CC1: When CC1 is displayed on TV means CC CAPTION is turned on.
CC2 to CC4: For other modes of video related broadcast information.
TT1: For program guide and other information displayed by broadcasters.
(This blocks a large portion of the picture on your screen).

Menu Operations

Function Menu Options Continued

TT2 to TT4 :For other modes of information displayed by broadcasters.
(This blocks a large portion of the picture on your screen).

IMPORTANT: Closed captioning availability entirely depends on broadcasters supplying the signal. Therefore, closed captioning might not always be available and language availability will differ by broadcast.

Note: Select **CC1** for full translation of the primary language such as English in your area. Select **CC2** for secondary language translation such as French or any other language that may be broadcast in your area.

5. **BLUE SCREEN:** Press **VOL+/VOL-** to select ON or OFF. To set ON, the screen will turn blue after 3 seconds if there is no signal.

6. **ASPECT RATIO:** Press to select display mode. (FULL SCREEN and ZOOM for model HLA15; FULL SCREEN ,4:3,16:9,CINEMA and ZOOM for model HLA19)

7. **RESET:** Press **VOL+** to reset some settings to the factory default .

Adjust Menu Options

1. Press **MENU** and **VOL+/VOL-** button until the following menu appears on the screen

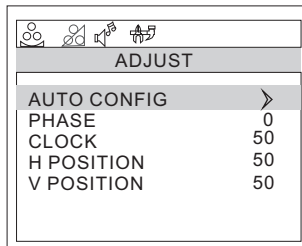

Note: This menu appears only in PC mode .

2. Press **CH+/CH-** button to enter the adjust menu and to go up and down to select the desired option .

3. Press **VOL+/VOL-** button to increase and decrease the level to adjust the selected option to your preference .

4. Repeat step 2 and step 3 until desired quality has been achieved .

Functions:

AUTO CONFIG: Automatically adjusts picture location frequency and phase parameters .

PHASE : Removes any horizontal distortion and clears or sharpens the displayed characters .

CLOCK : Adjust the TFT-LCD to match the PC input source clock frequency

Menu Operations

H POSITION : Picture horizontal position adjust

V POSITION : Picture vertical position adjust .

Tuning Menu Options

1. Press **MENU** and **VOL+/VOL-** button until the following menu appears on the screen

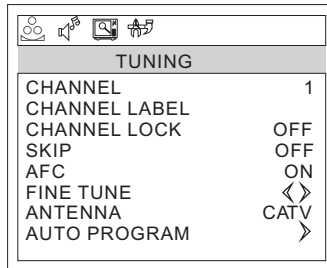

Note: This menu appears only in TV mode .

2. Press **CH+/CH-** button to enter the tuning menu and to go up and down to select the desired option .
3. Press **VOL+/VOL-** button to increase and decrease the level to adjust the selected option to your preference .
4. Repeat step 2 and step 3 until desired settings have been achieved .

Functions:

1. CHANNEL : Press **VOL+/VOL-** to go up and down to set the channel position. The display will show the current playing channel.

Channel Coverage by Antenna:	
Antenna Type	Channel Range
VHF	2-13
UHF	14-69
CATV	1-125

2. CHANNEL LABEL: Press **VOL+** to enter it, then press **VOL+/VOL-** to select the position you want to edit and press **CH+/CH-** to input the emblem such as character and so on. (There are 8 position for you to edit totally)
3. CHANNEL LOCK: Allows you to lock the channel inputs if ON is selected.

Menu Operations

Tuning Menu Options Continued

4. **SKIP** : If you want skip a channel , press **VOL+/VOL-** to select ON , and this channel will be skipped next time when you press **CH+/CH-** . You can press the digit buttons to select the channel . If you want to restore the channel , select OFF.
5. **AFC** : Auto frequency control. Select ON to improve image quality .
6. **FINE TUNE** : If the image and / or sound received is not very good , you can press **CH+/CH-** to select FINE TUNE in the menu . Then , press **VOL+/VOL-** button to adjust and improve the image quality. Do not use this feature unless reception is poor.
7. **ANTENNA**: Press **VOL+/VOL-** button to select AIR (VHF and UHF) and CATV reception preference.
8. **AUTO PROGRAM** : Auto search and program channels . Press the **VOL+** button to start to search the channel and the following menu will appear on the screen:



Press **VOL+/VOL-** or **CH+/CH-** to select YES or NO, and MENU to confirm. You could press **MENU** or **EXIT** to stop the search.

Note: The AUTO PROGRAM function will scan the channels on the selected antenna input. If the TV is connected to cable, please select CATV under 'ANTENNA' sub menu.

Parental Menu Options

1. Press the **MENU** and **VOL+/VOL-** button until FUNCTION menu appears on the screen .
2. Press **CH+/CH-** button to select PARENTAL and **VOL+** to enter.



3. Then input the password 0000. It will bring parental menu display on the screen. You will see the following menu on your screen:

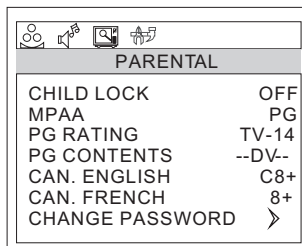

Menu Operations

Parental Menu Options Continued

This function enables you to block certain TV channels in accordance to the requirements established by the FCC.

2. Press **CH+/CH-** button to enter the PARENTAL menu and to go up and down to select the desired option .
3. Press **VOL+/VOL-** button to go into PG RATING and MPAA
Press **VOL+/VOL-** button to set the CHILD LOCK ON and PARENTAL LOCK OFF.
4. Repeat step 2 and step 3 until desired quality has been achieved .

CHILD LOCK: Child Lock off means the lock function is turned off . If the Child Lock is in "off" mode then function will not be active to accept the Parental Guidance signal. Child Lock on means the lock function is turned on. If the lock is in the "on" mode then it actively accepts the Parental Guidance signal.

MPAA: When MPAA rating is selected, you can select OFF/G/PG/PG 13 R/NC17/X .

PG RATING: Select the TV Rating option. You can select from OFF/TV-Y/TV-Y7/TV-G/TV-PG/TV-14/TV-MA.

PG CONTENTS: Press to set the grade of the program . When there is this grade of program , this program will not be display .

CAN. ENGLISH: Select this option. You could select from OFF/E/C/8+/G/PG/14+/18+ .

CAN. FRENCH: Select this option. You could select from OFF/E/G/8+/13+/16+/18+ .

CHANGE PASSWORD: The "Default Password" preset by the manufacturer is "0000" . If you want to change the preset password to your own password, just choose any four digits that can be easily remembered and set. Once you set password for a particular channel, that channel will be blocked.

Menu Operations

Parental Menu Options Continued

PARENTAL LOCK TECHNOLOGY:

The "P.L. Technology" allows you to use U.S. and Canadian Movies and TV PROGRAMS Guide ratings to block certain types of TV programs and movies.

To clearly understand TV program rating codes, read the following information:

U.S. TV Program Ratings

NR: Not Rated-this means that programs are not rated or rating does not apply.

TV-Y: For all children - these types of rated programs are designed for a very young audience, including children from ages 2-6.

TV-Y7: Directed towards older children - this type of rated programs may include comedic violence of mild physical, or may frighten children under the age of 7.

TV-G: General audience - these types of rated programs contains little or no violence, no strong language, and little or no sexual dialogue and situations.

TV-PG: Parental Guidance Suggested-this type of rated programs may contain limited violence, some suggestive sexual dialogue and situations, and rare language.

TV-14: Parents strongly cautioned-these types of rated programs may contain sexual content, strong language and more intense violence.

TV-MA: Mature audience only these types of rated programs may contain sexual violence, explicit sexual content and profane language.

FANTASY VIOLENCE: This type of rated programs contains Fantasy and cartoon violence.

VIOLENCE: This type of rated programs contains violence.

SEX: This type of rated programs contains sex.

LANGUAGE: This type of rated programs contains offensive language.

DIALOGUE: This type of rated programs contains dialogue with sexual content.

Menu Operations

Parental Menu Options Continued

To understand clearly about movie rating codes, read the following list:

U.S. Movie Rating Chart

- NR: This means movie is not rated yet. It is pending government rating approval.
- G: General Audience-this type of movie rating means all ages admitted to see the movie.
- PG 13:Parents Strongly Cautioned - this type of movie rating means some material may not be appropriate for children under13.
- R: Restricted- This type of movie rating means children under 17 of age require to be with parent or guardian.
- NC 17:This type of movie rating means no one 17 and under admitted.
- X: This type of movie rating means adults only.

To clearly understand Canadian program rating codes, read the following list:

Canadian English Rating Chart

- E: These types of programs are exempt from the rating system. Exempt programming includes: news, sports, documentaries, talk shows, music videos, and variety of other programs.
- C: This type of programming is intended for children under age 8. There is no offensive language, nudity or sexual content.
- C8+:These types of rated programs are generally considered acceptable for children 8 years and over. There is no profanity, nudity or sexual content.
- G: These types of rated programs are generally suitable for all audiences.
- PG: Parental Guidance Suggested -in these types of rated programs, some material may not be suitable for children.
- 14+: In these types of rated programs, some content may not be suitable for viewers under the age of 14.Parents are strongly cautioned not to have their children view 14+ rated programs by pre-teens and early teens.
- 18+: Adults Only-these types of rated programs are only for adult viewers only.

Troubleshooting Guide

- To assist in location possible faults use help guide below.

Troubleshooting

No picture, no sound	Verify that the television is properly plugged in. Verify that the television is properly supplied with power. Verify that electricity is available.
Blank screen	Verify that correct signals are input. Press TV/AV button to change signal input to TV input. Restart the television if power supply is interrupted.
No sound	Press MUTE button and verify if Mute mode is on. Switch to another channel and verify if the same problem happens. Press VOL+ button to see if the problem can be solved.
Poor sound	Verify that sound system is functional. Refer to chapter on adjusting.
No picture in some channel	Verify that correct channel is selected. Adjust the antenna. Make adjustments by FINE TUNE
No color for some channel program (black and white)	Verify that the same problem exists in other channels. Check picture and sound systems. Refer to relative instructions in the Manual for color adjust.
Spots with some or all pictures	Verify that the antenna is correctly connected. Verify that the antenna is in good condition. Make fine adjustment of channel.
Abnormal functioning	Disconnect the television from power supply and, 10 seconds later, reconnect to the power supply. If the problem still exists, contact an authorized service depot for technical assistance.

Note:

1. If the fault can not be repaired using the above guide consult with your local authorized service center.
2. The TV set must only be repaired by a qualified registered service person. Never attempt to remove the back cover as the TV set has dangerous voltage levels inside that may be fatal or cause fire.

Specifications

Specifications of the television that you have just purchased may vary from the information in this table due to technical innovations.

Model	HLA15	HLA19
Picture, sound system	NTSC-M, PAL/N, PAL/M	
Audio output	$\geq 1.5W+1.5W$	
External input port	AV input PC input S-VIDEO input PC audio input Headphone output YPbPr input Antenna input	
Power requirements	~100-240V 50/60Hz	
Power consumption	$\leq 50W$	$\leq 60W$
Temperature	Working: $+5^{\circ}C \sim +35^{\circ}C$ Storage: $-15^{\circ}C \sim +45^{\circ}C$	
Humidity	Working: 20%~80% Storage: 5%~90%	
Accessories	Remote control Batteries User manual	

NOTE

Design and specifications are subject to change without notice.
Dimensions quoted in this manual are approximate.

Haier®

V0.1
0090508051E

Free Manuals Download Website

<http://myh66.com>

<http://usermanuals.us>

<http://www.somanuals.com>

<http://www.4manuals.cc>

<http://www.manual-lib.com>

<http://www.404manual.com>

<http://www.luxmanual.com>

<http://aubethermostatmanual.com>

Golf course search by state

<http://golfingnear.com>

Email search by domain

<http://emailbydomain.com>

Auto manuals search

<http://auto.somanuals.com>

TV manuals search

<http://tv.somanuals.com>