

# Haier

## LCD TV RECEIVER

---

## USER'S MANUAL

Please read this manual carefully before using your television and keep this manual in a good place for future reference.

MODEL:  
L1509-A, L1510A-A, L1510B-A,  
L1709-A, L1910A-A, L1910B-A,  
L2009-A, L1911W-A, L2011W-A

**To users:**

Thank you for using our LCD-TV.

Before connecting the LCD-TV and turning the power on, please read this book carefully. Please keep this book for later use. When it was loss of function by electrostatic shock, please switch the on/off button for restoring the function.

## CONTENT

Safety Notice Items.....	1
Front Panel Controls.....	2
Connection Options.....	3
Remote Control Key Functions.....	4
Remote Control .....	5
Installing Batteries.....	5
Connection Instructions.....	6
Grounding.....	6
External equipment Connections.....	6
Antenna Connection.....	6
PC Setup.....	7
DVD Setup.....	7
VCR Setup.....	8
Cable TV Setup.....	9
External AV Source Setup.....	9
Basic Operating Instructions.....	10
Turn on the LCD-TV.....	10
Audio Control.....	10
Mute.....	10
Select the TV Channel You Want.....	11
Picture Mode.....	11
Menu Operations.....	12
Picture Menu Options.....	12
Picture Menu Options Continued.....	13
Audio Menu Options.....	13
Audio Menu Options Continued.....	14
Function Menu Options.....	15
Function Menu Options Continued.....	16
Adjust Menu Options.....	16
Tuning Menu Options.....	17
Tuning Menu Options Continued.....	18
TELETEXT.....	19
Troubleshooting Guide.....	21
Specifications.....	22

# Safety Notice Items

Incorrect usage will cause fire or electric shock. To prevent this, please do as required when you are installing, using and cleaning this machine. To insure your safety and extend the life-span of LCD-TV, please read the following items carefully before using:

- Please read and understand all the instructions before operation;
- Please keep the book for later use;
- Please comply with the warning instructions on the machine and in this book strictly;
- Please comply with the instructions provided;
- Please do not use additional devices that are not recommended by manufacturer:
- Before operation, please make sure that the operating voltage of your unit is normal;
- Do not place the unit on unstable, dusty and humid places;
- Never put the unit in direct sunlight or near heat sources;
- Allow enough space for proper ventilation;
- Please keep water away from the LCD-TV . If water comes in contact with the LCD-TV, disconnect the power cord from the power source, then wipe the set with a dry soft cloth;
- Do not remove the back cover. If services were need, please refer to qualified Personnel

# Front Panel Controls

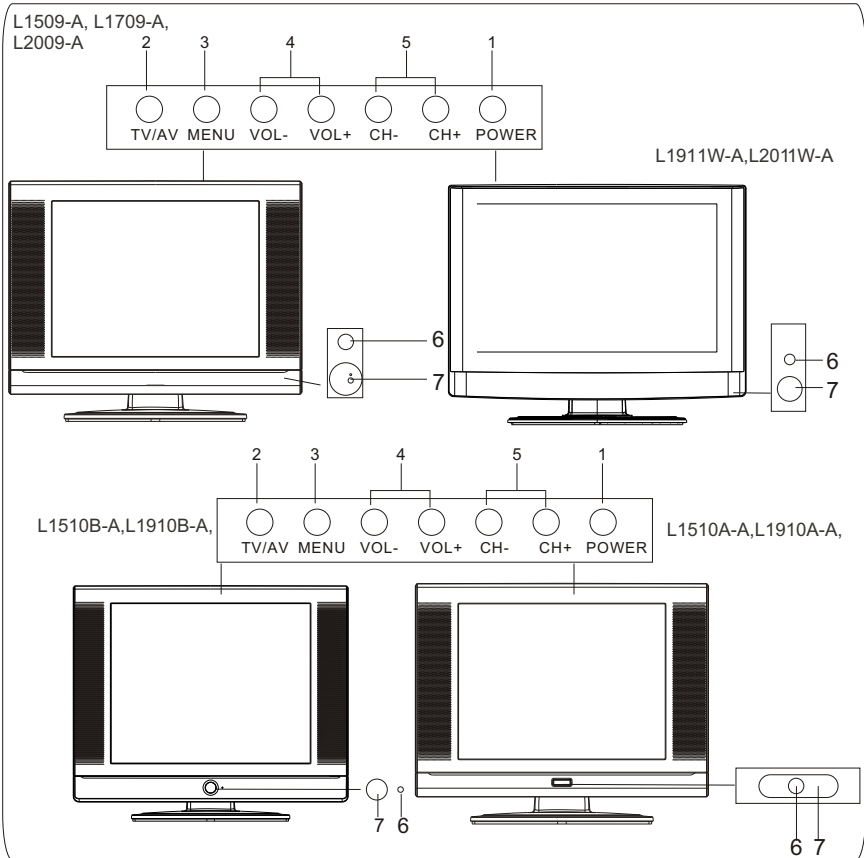

## Control Panel Function

1. Power supply switch
2. TV/AV Select the input signals: COMPONENT/PC/AV/SV/TV
3. MENU Press to select the main menu
4. VOL- Volume down / Left orientation to adjust the item in the OSD  
VOL+ Volume up / Right orientation to adjust the item/Press to enter
5. CH- TV channel down / to select the item in the menu  
CH+ TV channel up / to select the item in the menu
6. Power indicator  
Illuminates red in standby mode, illuminates green when the display is turned on (the 09 series is blue)
7. Remote Sensor Receiving remote control sends the infrared remote signal.

# Connection Options

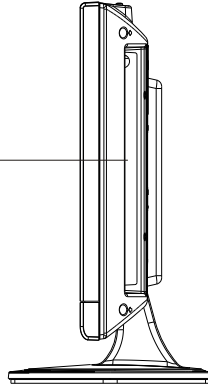
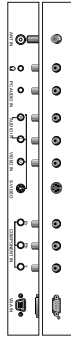

(The figure is just for reference, please see the real.  
The terminals of 09 series are opposite to the above.  
And the AC power supply switch is on the back of the set)

## AV/S-VIDEO/COMPONENT Audio Input

Connect audio output from an external device to this jack

## COMPONENT Input

Connect a component video/audio device to these jacks

## Earphone port

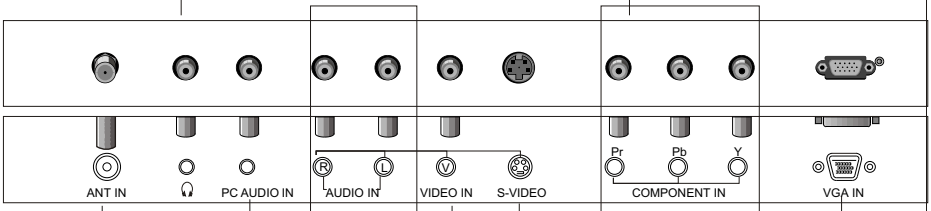

## PC Audio Input

Connect the PC output connector from a PC to the audio input port

## S-Video Input

Connect S-Video out from an S-Video device to the jacks.

## Antenna Input

Connect cable or antenna signals to the TV, either directly or through your cable box.

## Video Input

Connect video output from an external device to this jack

## VGA Input

Connect to the VGA 15PIN analog output connector of the PC display card for PC display purpose

# Remote Control Key Functions

When using the remote control, aim it towards the remote sensor on the TV

## Buttons on the remote control

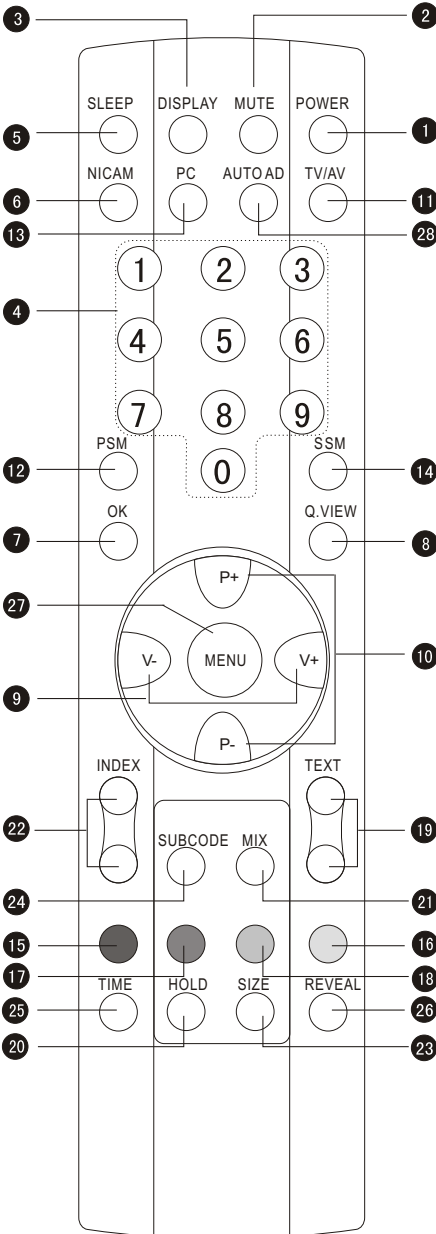

- 1 Stand By
- 2 MUTE
- 3 Display current input signal information
- 4 TV channel number select
- 5 Set time to change the TV into the standby status after a period of preset time.(time is 240/180/120/90/60/45/30/15/OFF)
- 6 NICAM/A2 Stereo select
- 7 EXIT
- 8 Quick TV channel switch(return to the last channel)
- 9 Volume down/up Left/right orientation to adjust the item in the OSD
- 10 TV channel up/down or select the item of the menu
- 11 Select COMPONENT/PC/AV/SV/TV
- 12 Select picture mode
- 13 PC system select
- 14 Select sound mode
- 15-18 Correspond to the differently colored subjects
- 19 Switch to the Teletext with text mode/turn off Teletext and switch to TV mode
- 20 Hold on or off for current page display
- 21 Switch to the Teletext with mix mode
- 22 Request index page
- 23 Change display size
- 24 Sub coded page access
- 25 While in normal TV mode only, pressing the button **TIME** will display the teletext time in the top right corner for a few seconds.
- 26 Reveal or hidden the hidden words
- 27 Press to select the main menu
- 28 Auto adjust (PC mode)

# Remote Control

## Installing Batteries

1. Slide open the cover of the battery compartment on the back of the remote control.
2. Load two 5# alkaline batteries in the compartment. (plus and minus poles to respective mark)
3. Replace the cover of the battery compartment.

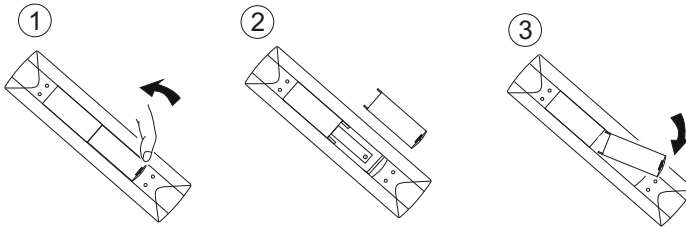

## Precautions

Make sure that there is no obstacle between the remote controller and television set.

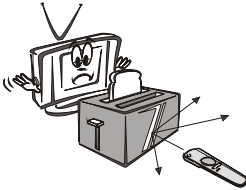

Keep the remote controller away from heat source or humid area to ensure effective performance of the remote controller.

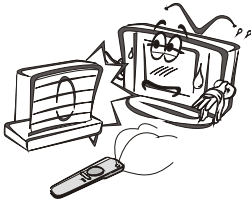

As strong light may interfere the signals, change your position to operate the remote controller if the television cannot be turned on or off as you expect.



Make sure that two 5# 1.5V alkaline batteries are loaded. The batteries must be of the same type. The batteries must be located properly. The batteries are not rechargeable.

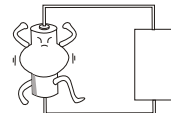

# Connection Instructions

## Grounding

Ensure that you connect the grounding / earth wire to prevent possible electric shock. If grounding methods are not possible, have a qualified electrician install a separate circuit breaker. Do not try to ground the unit by connecting it to telephone wires, lightening rods, or gas pipes.

## External Equipment Connections

### Antenna Connection

- Antenna or Cable Service with a Cable Box Connections
- For optimum picture quality, adjust antenna direction if needed.

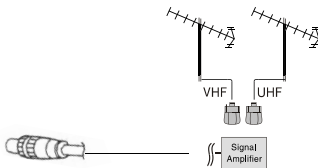
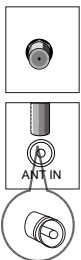
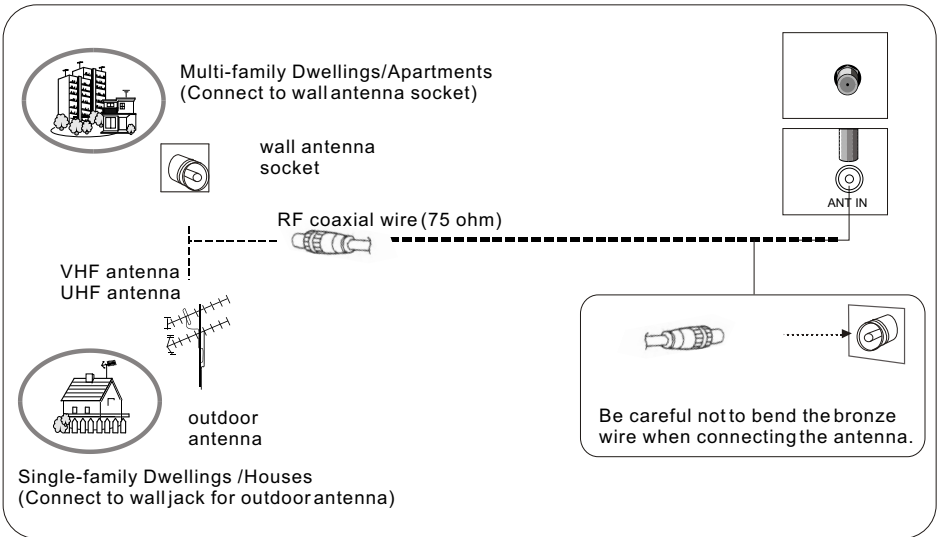

- To improve picture quality in a poor signal area, purchase and install a signal amplifier.
- If the antenna needs to be split for two TV' s, install a "2-Way Signal Splitter" in the connections.
- If the antenna is not installed properly, contact your dealer for assistance.

**NOTE: All cables shown are not included with the TV**



# Connection Instructions

## PC Setup

You can use your LCD-TV as a monitor for your personal computer using a VGA cable (not supplied).

### Connection and use steps:

1. Read the userguide supplied with your computer and ensure that it has a VGA connector;
2. Make sure that the power of the LCD -TV and the PC are off;
3. Connect a Dtype 15-pin VGA interface cable ( not supplied ) to the VGA video interface connector on the PC. Then connect the other end to the VGA video interface connector on the back of the LCD-TV. Tighten the screws on the VGA connectors once they are firmly connected;
4. Turn on the power of the LCD-TV first , and then turn on the power of the PC;
5. Press the TV/AV button to set the video input mode of the LCD-TV to PC-RGB;
6. Check the image on your TV. There may be noise associated with the resolution, vertical pattern, contrast or brightness in PC mode. If noise is present, change the PC mode to another resolution, change the refresh rate to another rate or adjust the brightness and contrast on the menu until the picture is clear. If the refresh rate of the PC graphic card can not be changed, change the PC graphic card or consult the manufacturer of the PC graphic card.

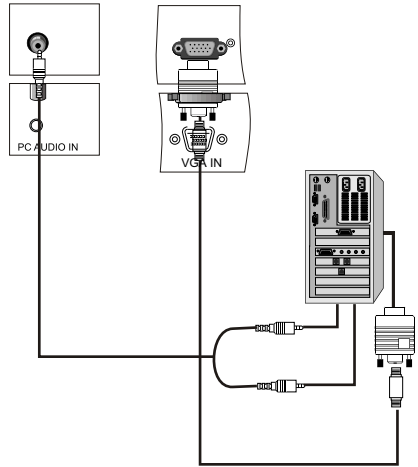

PC input:

Mode	Resolution	Line frequency (KHz)	Frame frequency (KHz)
VGA	640×480	31.5KHz	60Hz
SVGA	800×600	37.9KHz	60Hz
XGA	1024×768	48.4KHz	60Hz

Note: All above listed are subject to VESA Criteria.

## DVD Setup

### How to connect

Connect the DVD video outputs (Y, PB, PR) to the COMPONENT (Y, Pb, Pr) IN jacks on the TV and connect the DVD audio outputs to the AUDIO IN jacks on the TV, as shown in the figure.

**NOTE:** If your DVD player does not have component video output, use S-Video.

### How to use

1. Turn on the DVD player, insert a DVD.
2. Use the **TV/AV** button on the remote control to select

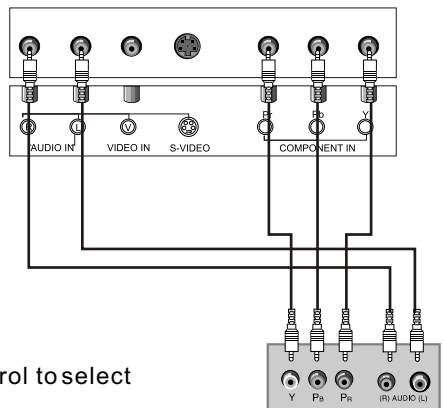

# Connection Instructions

COMPONENT (If connected to SVIDEO, select the SV external input source.)

3. Refer to the DVD player's manual for operating instructions.

## Component Input ports

To get better picture quality, connect a DVD player to the component input ports as shown below.

Component ports on the TV	Y	P <sub>B</sub>	P <sub>R</sub>
---------------------------	---	----------------	----------------

Video output ports on DVD player	Y	P <sub>b</sub>	P <sub>r</sub>
	Y	B-Y	R-Y
	Y	Cb	Cr
	Y	P <sub>B</sub>	P <sub>R</sub>

## VCR Setup

- To avoid picture noise (interference), leave an adequate distance between the VCR and TV

### Connection and use steps:

1. Read the user guide supplied with your AV devices and ensure that it has Composite or S-Video connectors;
2. Make sure that the power of the LCD-TV and the AV device are off;

### Connection Option 1

Set VCR output switch to 3 or 4 and then tune TV to the same channel number.

### Connection Option 2

1. Connect the audio and video cables from the VCR's output jacks to the TV input jacks, as shown in the figure.

When connecting the TV to VCR, match the jack colors (Video = yellow, Audio Left = white, and Audio Right = red).

If you connect an S-VIDEO output from VCR to the S-VIDEO input, the picture quality is improved; compared to connecting a regular VCR to the Video input.

2. Insert a video tape into the VCR and press PLAY on the VCR. (Refer to the VCR owner's manual.)
3. Turn on the power of the LCD-TV first; and then turn on the power of the AV device;
4. Press the TV/AV button to set the video input mode of the LCD-TV to S-VIDEO mode or AV mode.

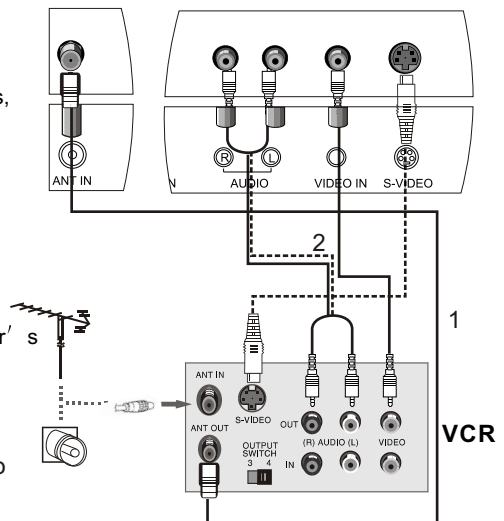

# Connection Instructions

## Cable TV Setup

- After subscribing to a cable TV service from a local provider you can watch cable TV programming. The TV cannot display TV programming unless a TV tuner device or cable TV converter box is connected to the TV.
- For further information regarding cable TV service, contact your local cable TV service provider(s).

### Connection Option 1

1. Select 3 or 4 with channel switch on cable box.
2. Tune the TV channel to the same selected output channel on cable box.
3. Select channels at the cable box or with the cable box remote control.

### Connection Option 2

1. Connect the audio and video cables from the Cable Box's output jacks to the TV input jacks, as shown in the figure. When connecting the TV to a Cable Box, match the jack colors (Video = yellow, Audio Left = white, and Audio Right = red).
2. Select the input source by using the **TV/AV** button on the remote control.
3. Select your desired channel with the remote control for cable box.

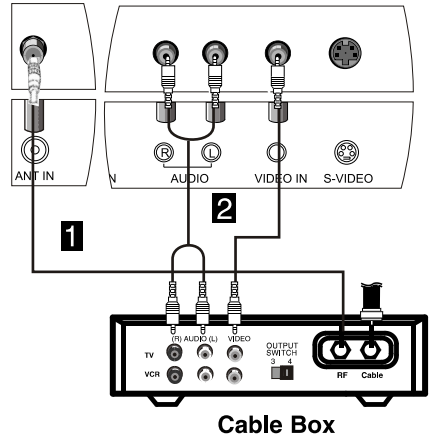

## External AV Source Setup

### How to connect

Connect the audio and video cables from the external equipment's output jacks to the TV input jacks, as shown in the figure. When connecting the TV to external equipment, match the jack colors (Video = yellow, Audio Left = white, and Audio Right = red).

### How to use

1. Select the input source by using the **TV/AV** button on the remote control.
2. Operate the corresponding external equipment. Refer to external equipment operating guide.

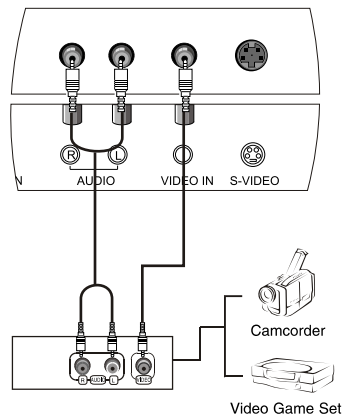

# Basic Operating Instructions

## Turn on the LCD-TV

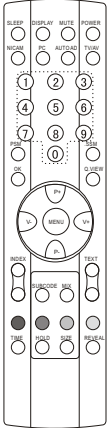

Switch on the power button on the back of the set and the TV will in standby mode. When the **POWER** button on the remote control is pressed and the LCD-TV is turned on, the indicator light on the front of the LCD-TV changes from red to green. When the LCD-TV is turned off using the **POWER** button, the LCD-TV will go into standby mode and the indicator light turns red.

**Note:**  
The display of the input mode will disappear in 3 seconds.

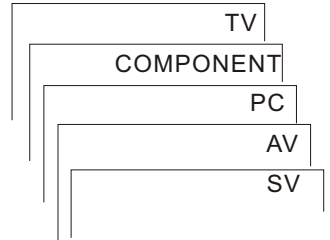

Switch Among Different Inputs: TV / COMPONENT / PC / AV / SV

Each time you press the TV/AV button, TV, COMPONENT, PC, AV, SV, will appear on the screen in the order.

**Note:**

The display of the input mode will disappear in 3 seconds.

## Audio Control

1. Press the **V+** button to increase the volume. A number will appear on screen indicating the volume level.
2. Press the **V-** button to decrease the volume. A number will appear on screen indicating the volume level.

## Mute

1. Press the **MUTE** button to mute the sound temporarily. A mute icon appears on the screen.
2. Press the **MUTE** button or **V+/V-** again to restore the sound. The mute icon disappears.

# Basic Operating Instructions

## Select the TV Channel You Want

You can use the number keys on the remote control to directly select TV channels.

The LCD-TV can store up to 100 channels, and you can press the keys on the remote control or on the panel to make a selection.

1. Press the relevant key on the remote control if you want to choose any channel from 0 to 9. (for example: if you want to choose channel 8, just press the key number 0 and 8.)

**Note: You must press 0 first and then the other numbers from 0 to 9 if you want to choose channels from 0 to 9)**

2. If you want to choose a channel bigger than 9, please enter the two digits of the channel number you want to watch within 3 seconds. (for example: select channel 16)

## Picture Mode

Press PSM button on the remote control for menu display. For desired mode as follows:

PERSONAL → STANDARD → MILD → FRESH

# Menu Operations

\* In this manual, the OSD (On Screen Display) may be different from your TV's because it is just an example to help you with the TV operation. Press TV/AV to select the input source, and the menu in the different source is different .

1. Press **MENU** button to display the main menu, and **V+/V-** to select the main menu .
2. Press **P+/P-** to scroll through the parameters
3. Press **V+/V-** buttons to make changes to the parameters
4. Press the **OK** button to exit the menu

## Picture Menu Options

Picture quality can be adjusted for any input separately .

The picture quality on the screen can be adjusted as follows:

1. Press **MENU** button and **V+/V-** until the following menu appears on the screen.

### PC/COMPONENT MENU

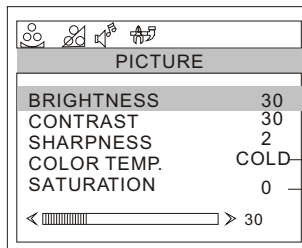

Only available in PC mode

Only available in COMPONENT mode

### TV/AV/SV MENU

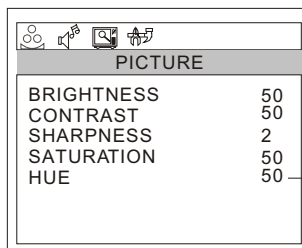

Only available in NTSC system

Note: Sign on top of the menu in this manual may be different from the real

# Menu Operations

## Picture Menu Options Continued

2. Press **P+/P-** button to enter the picture menu and to go up and down to select the desired option .
3. Press **V+/V-** button to increase and decrease the level to adjust the selected option to your preference .
4. Repeat step 2 and step 3 until desired picture quality has been achieved .

### **Function:**

**BRIGHTNESS** :Adjust the brightness of the picture . By increasing the level, it will add more light to dark parts of the picture and by decreasing the level ,it will add more dark to light parts of the picture.

**CONTRAST** : Adjust the contrast of the picture . The image becomes higher as the number increase.

**SHARPNESS** : Adjust the amount of the detail enhancement , the image sharpness rises as the number increases (By increasing the level, it will show cleaner and clearer images and by decreasing the level, it will make picture smoother).

**SATURATION** : Press **V+/V-** to adjust the color

**HUE** : Adjust the tone of the picture . Appear and be adjusted only under NTSC mode

**COLOR TEMP.** : Press to select the color temperature from WARM/NORMAL/ COLD .

## Audio Menu Options

Sound can be adjusted for any input as follows:

1. Press **MENU** and **V+/V-** button until the following menu appears on the screen

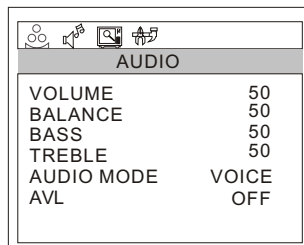

# Menu Operations

## Audio Menu Options Continued

You can adjust sound options to the levels you prefer.

2. Press **P+/P-** button to enter the audio menu and to go up and down to select the desired option .
3. Press **V+/V-** button to increase and decrease the level to adjust the selected option to your preference .
4. Repeat step 2 and step 3 until desired sound quality has been achieved ..

### **Function :**

**VOLUME :** Adjust the volume of your TV

**BALANCE :** Adjust the balance of the audio output from left to right . When indication value of balance increases toward +50 , sound of the left speaker becomes weaker . When indication value of balance decreases toward -50 , sound of the right speaker become weaker .

**BASS :** Adjust the bass of the sound . Can only be adjust under PERSONAL mode .

**TREBLE :** Adjust the treble of the sound . Can only be adjust under PERSONAL mode .

**AUDIO MODE :** Press **V+/V-** to select among PERSONAL, VOICE, MUSIC and THEATRE .

**AVL:** Automatic Volume Limit Control reduces the effect of the large volume by the same volume of all the channels .



# Menu Operations

## Function Menu Options

### Menu Language Selection:

The menus can be shown on the screen in the selected language. First select your language.

1. Press **MENU** and **V+/V-** button until the following menu appears on the screen
2. Press **P+/P-** button to select LANGUAGE.
3. Press **V+/V-** button to select your desired language.

From this point on, the on-screen menus will be shown in the language of your choice.

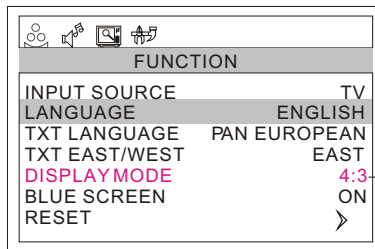

1. Press **MENU** button and **V+/V-** until the following menu appears on the screen.

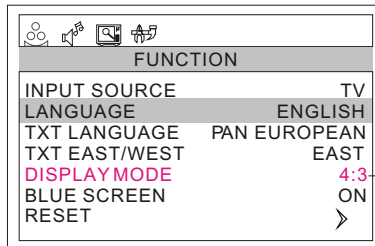

2. Press **P+/P-** button to enter the function menu and to go up and down to select the desired option .
3. Press **V+/V-** button to increase and decrease the level to adjust the selected option to your preference .
4. Repeat step 2 and step 3 until desired picture quality has been achieved .

Functions:

1. INPUT SOURCE : Display current mode . There are PC , AV , SV , TV , COMPONENT to display .

# Menu Operations

## Function Menu Options Continued

2. **TXTLANGUAGE**: To switch the teletext languages.
3. **TXTEAST/WEST**: To select EAST or WEST
4. **DISPLAY MODE**: To select the display mode between 4:3 and FULL SCREEN..
5. **BLUE SCREEN**: To set On, the screen will be in blue screen after 3 seconds if there is no signal.
6. **RESET** : Press **V+** to reset some settings to the factory default .

**Note:** The **TXT LANGUAGE** and **TXT EAST/WEST** have relation to the inputs.

## Adjust Menu Options

1. Press **MENU** and **V+/V-** button until the following menu appears on the screen

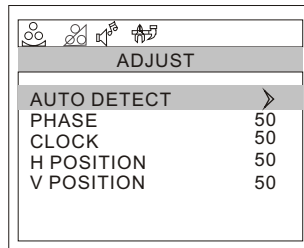

**Note: This menu is only appears in PC mode.**

2. Press **P+/P-** button to enter the adjust menu and to goup and down to select the desired option .
3. Press **V+/V-** button to increase and decrease the level to adjust the selected option to your preference .
4. Repeat step 2 and step 3 until desired quality has been achieved ..

Functions:

**AUTO SYNC** : Is opted for adjustment of picture location frequency and phase parameters .

**PHASE** : Removes any horizontal distortion and clears or sharpness the displayed characters .

**CLOCK** : Adjust the TFT-LCD to match the PC input source

**H-POSITION** : Picture horizontal adjust

**V-POSITION** : Picture vertical position adjust.

# Menu Operations

## Tuning Menu Options

1. Press **MENU** and **V+/V-** button until the following menu appears on the screen

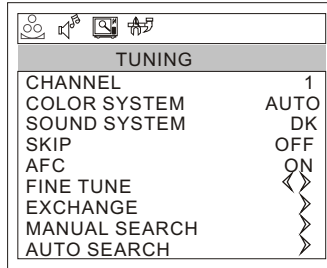

**Note: This menu is only appears in TV mode.**

2. Press **P+/P-** button to enter the tuning menu and to go up and down to select the desired option .
3. Press **V+/V-** button to increase and decrease the level to adjust the selected option to your preference .
4. Repeat step 2 and step 3 until desired quality has been achieved ..

Functions:

1. CHANNEL : Press **V+/V-** to change the TV channel .
2. COLOR SYSTEM : Select the TV color system from AUTO, PAL, SECAM.
3. SOUND SYSTEM : Select the TV standard system from DK, I, BG
4. SKIP : If you want skip a channel , press **V+/V-** to select ON , and this channel will be skip next time when you press **P+/P-** . But you can press digits button to select the channel . If you want to restore the channel , select OFF.
5. AFC: Auto frequency control . Select ON to improve the image quality .
6. FINE TUNE : If the image received is not very good , you can press **P+/P-** to select FINE TUNE item in menu . Then , press **V+/V-** button to adjust and improve the image quality .

# Menu Operations

## Tuning Menu Options Continued

7. EXCHANGE : Press **V+** to display the menu as follows:

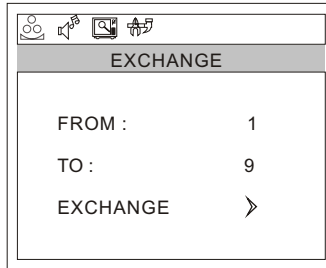

Press **P+/-** to select the item and then **V+/-** to adjust the channel and **V+** to confirm. (For example: press **P+/-** to select FROM item, and then press **V+/-** to adjust the channel number to 1 and the current channel will change with the channel number changed; then Press **P+/-** to select TO item, and **V+/-** to adjust the channel number to 9 and the current channel will not change; press **P+/-** to select EXCHANGE item, and then **V+** to confirm. The two channels will be exchanged)

8. MANUAL SEARCH : Press **V+** to start to search the channel . The following menu will display on the screen:

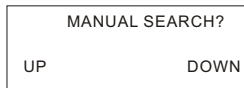

Press **V+/-** to select UP or DOWN, and then press MENU to confirm. (If you select DOWN, the search will search the lower frequency channel and UP will search the higher frequency channel)

9. AUTO SEARCH : Auto search and save the channel . Press the **V+** button to start to search the channel and the following menu will appears on the screen: All channels now playing program will be automatically preset in order . After the search has finished, the first program number will display on the screen.

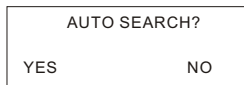

Press **V+/-** to select YES or NO, and menu to confirm. You could press MENU to stop the search.

**NOTE:** If you want to search the channels in L or L' system, you need to set the sound system to L in OSD

# TELETEXT

Some menu related function are not available in TELETEXT mode. MENU and AUTOAD control functions are not available in TELETEXT mode. If the TV is switched on by POWER after off in TELETEXT mode, or press TV/AV or PC button, the TELETEXT mode will disappear automatically.

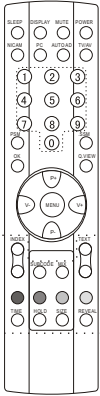

Teletext features may vary depending on the Broadcasting Companies and is only available if the channel selected is transmitting Teletext. Pressing the TEXT button whilst in Teletext operation will switch the current status to TV. When in Teletext mode, the volume may still be altered to the desired listening level.

## Page Selection

Pages can be selected in two ways:

- Press **P+** or **P-** button to increase or decrease the page number by one.
- By entering the page number, using the number keys on the remote control.

## SIZE Button

Press SIZE button to change display size : normal→large top→large bottom→normal

## REVEAL Button

Press REVEAL to reveal hidden words e.g. Quiz page answers . Press again to hide.

## Red/Green/ Yellow/Cyan Buttons

These four buttons correspond to the differently colored subjects .

## HOLD Button

Press HOLD button to remain the Teletext page when viewing multi-page information .

## INDEX Button

Press INDEX button to return to the main index page . Depending on the way information is transmitted , this may have to be pressed more than once to return to the main index page .

# TELETEXT

## **SUBCODE Button**

When Teletext information exceeds more than one page , it may take some time for the automatic changing of the sub pages to reach the sub page you require . It is possible to enter your required sub page and continue watching the normal programme until the correct sub page is found .

Select the required page number using buttons 0-9 .

If the top of the page indicates that sub pages are being transmitted yet the page does not change . Then the number at the top of the page is there to indicate that the broadcaster has updated the page' s contents , there are no sub pages . Press SUBCODE button , page numberS--- will be displayed at the bottom right of the screen.

Enter desired sub page number before the page number/--- disappears . To select page 6 enter 0,0,0 and 6 .

## **TEXT Button**

Press TEXT to enter Teletext mode and only the text page can be visible .

## **MIX Button**

Press MIX button to enter Teletext mode and both the TV picture and text page can be visible.

## **TIME**

While in normal TV mode only, pressing the button **TIME** will display the teletext time in the top right corner for a few seconds.

# Troubleshooting Guide

- To assist in location possible faults use help guide below.

## Troubleshooting

No picture, no sound	Verify if the television is properly plugged. Verify if the television is properly supplied power. Verify if electricity is available.
Blank screen	Verify if correct signals are input. Press TV/AV button to change signal input to TV input. Restart the television if power supply is interrupted.
No sound	Press MUTE button and verify if Mute mode is set. Switch to other channel and verify if the same problem happens. Press VOL+ button to see if the problem can be solved.
Poor sound	Verify if sound system is correct. Refer to some chapter for adjust.
No picture in some channel	Verify if correct channel is selected. Adjust the antenna. Make adjustments by FINE TUNE and MANUAL SEARCH.
No color for some channel program (black and white)	Verify if the same problem exists in other channels. Check out of picture and sound systems. Refer to relative instructions in the Manual for color adjust.
Spots with some or all pictures	Verify if the antenna is correctly connected. Verify if the antenna is in good condition. Make fine adjustment of channel.
Television out of control	Disconnect the television from power supply and, 10 seconds later, connect the television to the power supply. If the problem still exists, contact authorized after-sales service for technical assistance.

### Note:

1. If the fault can not be repaired using the above guide consult with your local authorized service center.
2. The TV set must only be repaired by a qualified registered service person. Never attempt to remove the back cover as the TV set has dangerous voltages inside that may cause a fatality or fire.

# Specifications

Specifications of the television that you have just purchased may vary from the information in this table due to technical innovations.

<b>Model</b>	L1509-A/L1510A-A/ L1510B-A/L1709-A	L1910A-A/L1910B-A/L2009-A/ L1911W-A/L2011W-A
<b>Picture, sound system</b>	PAL/SECAM-BG,I,DK	
<b>DTV YPbPr YCbCr</b>	480i/p, 576i/p, 720p. 1080i	
<b>Audio output</b>	≥1.5W+1.5W	
<b>External port</b>	AV input PC input S-VIDEO input PC audio input Headphone output COMPONENT input Antenna input	
<b>Power requirements</b>	~150-240V 50/60Hz	
<b>Power consumption</b>	≤50W	≤60W
<b>Temperature</b>	Working:5°C~35°C Storage:-10°C~45°C	
<b>Humidity</b>	Working:20%~80% Storage:5%~90%	
<b>Accessories</b>	Remote control Batteries Owner's manual Warranty card	

Note: Warranty card is only for the special countries and areas

● **Note:**

**All specifications are subject to change without notice.  
All quality are approximate value.**



# Haier

V0.1  
0090508262

## Free Manuals Download Website

<http://myh66.com>

<http://usermanuals.us>

<http://www.somanuals.com>

<http://www.4manuals.cc>

<http://www.manual-lib.com>

<http://www.404manual.com>

<http://www.luxmanual.com>

<http://aubethermostatmanual.com>

Golf course search by state

<http://golfingnear.com>

Email search by domain

<http://emailbydomain.com>

Auto manuals search

<http://auto.somanuals.com>

TV manuals search

<http://tv.somanuals.com>