



15"17"20"LCD TV

USER'S MANUAL

Please read this manual carefully before using your television and keep this manual in a good place for future reference.

MODEL:
L15SV6-A0, L17LV6-A1, L20AV6-A0
L17L6A-G1, L20L6A, L15G1-A0,
L17G1-A0, L20G1-A0, L15D2-A0,
L17D2-A0

To users:

Thank you for using our LCD-TV. After unpacking, please check that you have the following items: Operating instructions, Remote control, AC-DC adapter, AC wire, and Batteries.

Before connecting the LCD-TV and turning the power on, please read this book carefully. Please keep this book for later use. When it was loss of function by electrostatic shock, please switch the on/off button for restoring the function.

CONTENT

Safety Notice Items.....	1
Main Functions.....	1
Front Panel Controls.....	2
Connection Options.....	3
Remote Control Key Functions.....	4
Installing Batteries.....	5
Connection Instructions.....	6
Grounding.....	6
External equipment Connections.....	6
Antenna Connection.....	6
PC Setup.....	7
VCR Setup.....	8
Cable TV Setup.....	9
External AV Source Setup.....	9
Basic Operating Instructions.....	10
Turn on the LCD-TV.....	10
Audio Control.....	10
Mute.....	10
Select the TV Channel You Want.....	11
Picture Mode.....	11
TELETEXT.....	12
Menu Operations.....	14
Picture Menu Options.....	14
Picture Menu Options Continued.....	15
Picture Menu Options Continued.....	16
Sound Menu Options.....	16
Sound Menu Options Continued.....	17
General Menu Options.....	17
General Menu Options Continued.....	18
TV Menu Options.....	19
TV Menu Options Continued.....	20
Specifications.....	21

Safety Notice Items

Incorrect usage will cause fire or electric shock. To prevent this, please do as required when you are installing, using and cleaning this machine. To insure your safety and extend the life-span of LCD-TV, please read the following items carefully before using:

- Please read and understand all the instructions before operation;
- Please keep the book for later use;
- Please comply with the warning instructions on the machine and in this book strictly;
- Please comply with the instructions provided;
- Please do not use additional devices that are not recommended by manufacturer:
- Before operation, please make sure that the operating voltage of your unit is normal;
- Do not place the unit on unstable, dusty and humid places;
- Never put the unit in direct sunlight or near heat sources;
- Allow enough space for proper ventilation;
- Please keep water away from the LCD-TV . If water comes in contact with the LCD-TV, disconnect the power cord from the power source, then wipe the set with a dry soft cloth;
- Do not remove the back cover. If services were need, please refer to qualified Personnel

Main Functions

- 1-Can be connected with analog RGB input
- 2-Can be connected with CVBS,S-VIDEO, , and SCART (CVBS/RGB) input
- 3-Can receive TV signal

Front Panel Controls

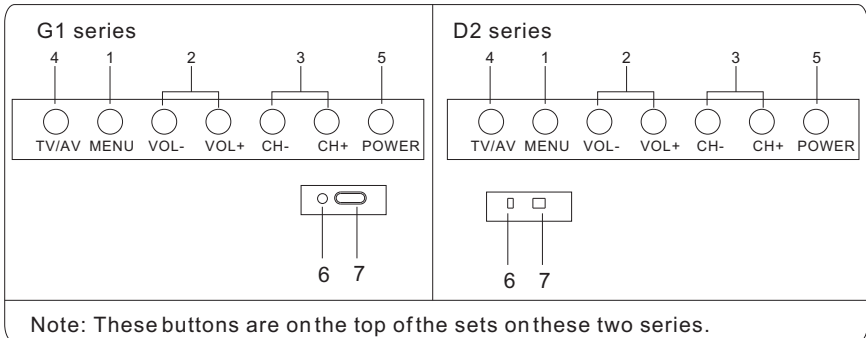
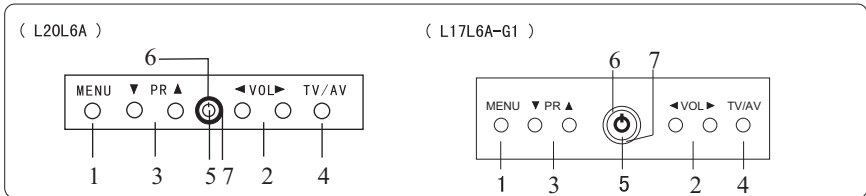
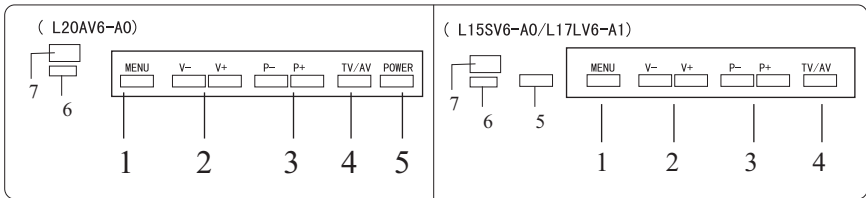

Note: These buttons are on the top of the sets on these two series.

Control Panel Function

1. MENU Press to select the main menu
2. ◀ VOL (V-/VOL-) Volume down / Left orientation to adjust the item in the OSD
VOL▶ (V+/VOL+) Volume up / Right orientation to adjust the item / Press to enter the submenu.
3. ▼ PR (P-/CH-) TV channel down / to select the item in the menu
PR ▲ (P+/CH+) TV channel up / to select the item in the menu
4. TV/AV Select the input signals: SCART/PC-RGB/AV/S-VIDEO/TV
5. Power supply switch
6. Power indicator
Illuminates red in standby mode, illuminates green when the display is turned on
7. Remote Sensor Receiving remote control sends the infrared remote signal.

Connection Options

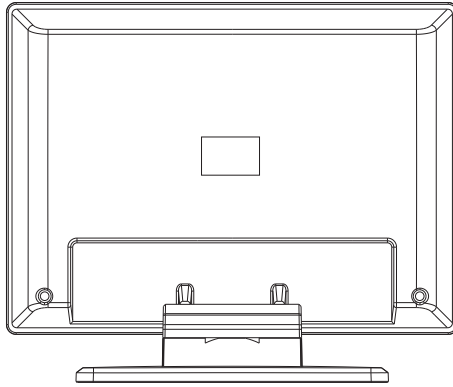

(The figure is just for reference, please see the real.)

D-SUB Input

Connect to the D-SUB 15PIN analog output connector of the PC display card for PC display purpose

SCART Input

Connect to the DVD/VCR/broadcasting receiver or other equipment

AV Audio Input

Connect audio/video output from an external device to these jacks

Earphone port

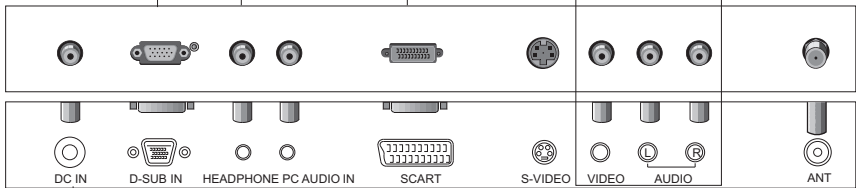

PC Audio Input

Connect the PC output connector from a PC to the audio input port

S-Video Input

Connect S-Video out from an S-Video device to the jacks.

DC Power Cord Socket

This TV operates on DC power. The voltage is indicated on the Specifications page. Never attempt to operate the TV on AC power.

Antenna Input

Connect cable or antenna signals to the TV, either directly or through your cable box.

Remote Control Key Functions

When using the remote control, aim it towards the remote sensor on the TV

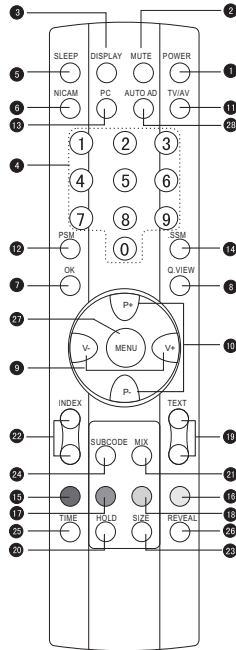

Illustration of the keys on the remote control:

1. POWER	Power supply switch
2. MUTE	MUTE
3. DISPLAY	Display current input signal information
4. 0-9	TV channel number select
5. SLEEP	Set time to change the TV into the standby status after a period of preset time.(time is 240/180/120/90/60/45/30/15/0)
6. NICAM	NICAM/A2 Stereo select
7. OK	EXIT
8.Q.VIEW	Quick TV channel switch(return to the last channel)
9. V-	Volume down/ Left orientation to adjust the item in the OSD
V+	Volume up/ Right orientation to adjust the item/Press to enter the submenu.
10. P+/P-	TV channel up/down or select the item of the menu
11. TV/AV	Select SCART/PC-RGB/AV/S-VIDEO/TV
12. PSM	Select picture mode: PERSONAL/STANDARD/MILD/FRESH

Remote Control Key Functions

13. PC	PC-RGB system select	
14. SSM	Select sound mode:VOICE/MUSIC/THEATRE/PERSONAL	
28. AUTO AD	Auto adjust (PC mode)	
T E L E T E X T	15. RED	Correspond to the differently colored subjects
	16. CYAN	
	17. GREEN	
	18. YELLOW	
	19. TEXT	Switch to the Teletext with text mode/turn off Teletext and switch to TV mode
	20. HOLD	Hold on or off for current page display
	21. MIX	Switch to the Teletext with mix mode
	22. INDEX	Request index page
	23. SIZE	Change display size
	24. SUBCODE	Sub coded page access
25. TIME	While in normal TV mode only, pressing the button TIME will display the teletext time in the top right corner for a few seconds.	
26. REVEAL	Reveal or hidden the hidden words	
27. MENU	Press to select the main menu	

Note:

The buttons instruction for the operation just take remote controller for example in this manual . Buttons (MENU , V+/- or ◀VOL▶ or VOL+/-, P+/- or ▼PR▲ or CH+/-, TV/AV, POWER or ⏻) on the TV panel is corresponding with buttons (MENU, V+/-, P+/- , TV/AV , POWER) on the remote controller.

Installing Batteries

1. Slide open the cover of the battery compartment on the back of the remote control.
2. Load two 5#alkaline batteries in the compartment. (plus and minus poles to respective mark)
3. Replace the cover of the battery compartment.

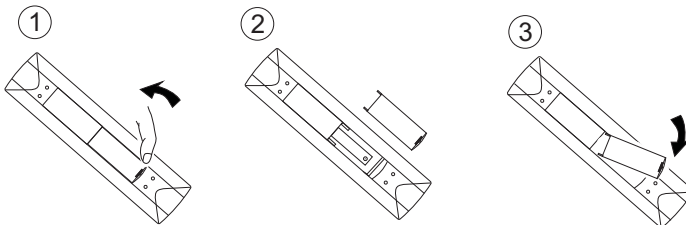

Connection Instructions

Grounding

Ensure that you connect the grounding / earth wire to prevent possible electric shock. If grounding methods are not possible, have a qualified electrician install a separate circuit breaker. Do not try to ground the unit by connecting it to telephone wires, lightening rods, or gas pipes.

External Equipment Connections

Antenna Connection

- Antenna or Cable Service with a Cable Box Connections
- For optimum picture quality, adjust antenna direction if needed.

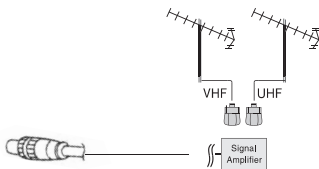
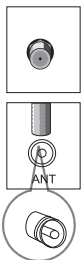
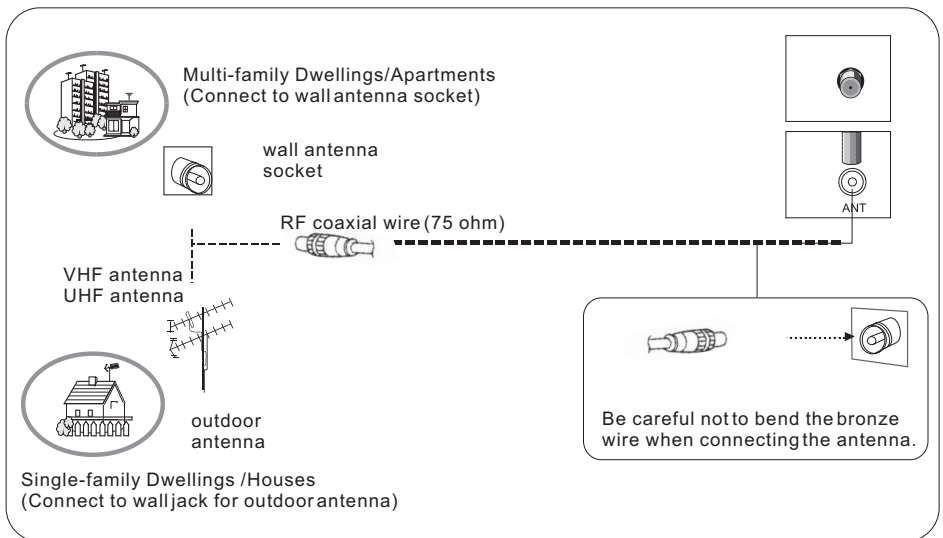

- To improve picture quality in a poor signal area, purchase and install a signal amplifier.
- If the antenna needs to be split for two TV' s, install a "2-Way Signal Splitter" in the connections.
- If the antenna is not installed properly, contact your dealer for assistance.

NOTE: All cables shown are not included with the TV

Connection Instructions

PC Setup

You can use your LCD-TV as a monitor for your personal computer using a VGA cable (not supplied).

Connection and use steps:

1. Read the user guide supplied with your computer and ensure that it has a VGA connector;
2. Make sure that the power of the LCD-TV and the PC are off;
3. Connect a D type 15-pin VGA interface cable (not supplied) to the VGA video interface connector on the PC. Then connect the other end to the VGA video interface connector on the back of the LCD-TV. Tighten the screws on the VGA connectors once they are firmly connected;
4. Turn on the power of the LCD-TV first, and then turn on the power of the PC;
5. Press the TV/AV button to set the video input mode of the LCD-TV to PC-RGB;
6. Check the image on your TV. There may be noise associated with the resolution, vertical pattern, contrast or brightness in PC mode. If noise is present, change the PC mode to another resolution, change the refresh rate to another rate or adjust the brightness and contrast on the menu until the picture is clear. If the refresh rate of the PC graphic card can not be changed, change the PC graphic card or consult the manufacturer of the PC graphic card.

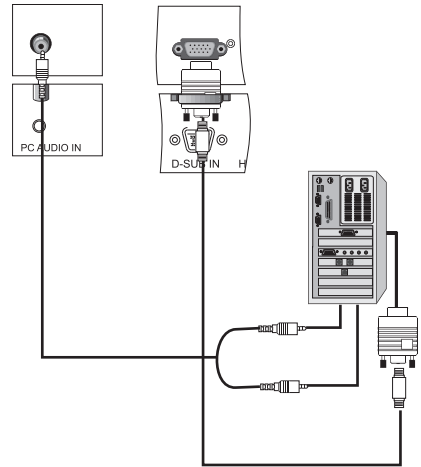

Connection Instructions

VCR Setup

- To avoid picture noise (interference), leave an adequate distance between the VCR and TV

Connection and use steps:

1. Read the user guide supplied with your AV devices and ensure that it has Composite or S-Video connectors;
2. Make sure that the power of the LCD-TV and the AV device are off;

Connection Option 1

Set VCR output switch to 3 or 4 and then tune TV to the same channel number.

Connection Option 2

1. Connect the audio and video cables from the VCR's output jacks to the TV input jacks, as shown in the figure.

When connecting the TV to VCR, match the jack colors (Video = yellow, Audio Left = white, and Audio Right = red). If you connect an S-VIDEO output from VCR to the S-VIDEO input, the picture quality is improved; compared to connecting a regular VCR to the Video input.

2. Insert a video tape into the VCR and press PLAY on the VCR. (Refer to the VCR owner's manual.)
3. Turn on the power of the LCD-TV first; and then turn on the power of the AV device;
4. Press the TV/AV button to set the video input mode of the LCD-TV to S-VIDEO mode or AV mode.

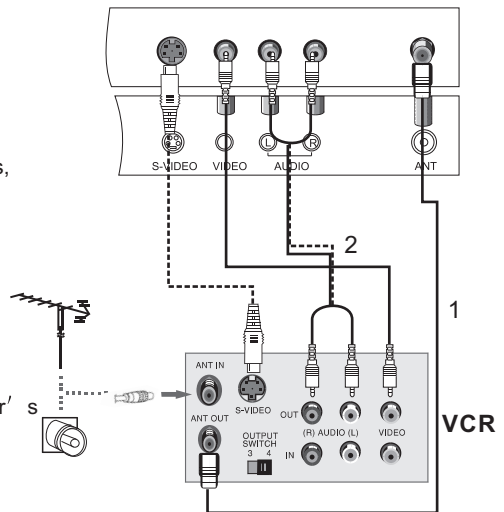

Connection Instructions

Cable TV Setup

- After subscribing to a cable TV service from a local provider you can watch cable TV programming. The TV cannot display TV programming unless a TV tuner device or cable TV converter box is connected to the TV.
- For further information regarding cable TV service, contact your local cable TV service provider(s).

Connection Option 1

1. Select 3 or 4 with channel switch on cable box.
2. Tune the TV channel to the same selected output channel on cable box.
3. Select channels at the cable box or with the cable box remote control.

Connection Option 2

1. Connect the audio and video cables from the Cable Box's output jacks to the TV input jacks, as shown in the figure. When connecting the TV to a Cable Box, match the jack colors (Video = yellow, Audio Left = white, and Audio Right = red).
2. Select the input source by using the **TV/AV** button on the remote control.
3. Select your desired channel with the remote control for cable box.

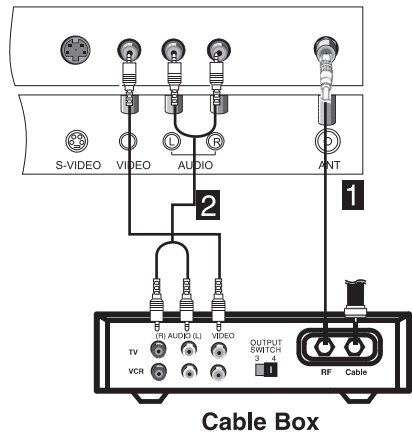

External AV Source Setup

How to connect

Connect the audio and video cables from the external equipment's output jacks to the TV input jacks, as shown in the figure.

When connecting the TV to external equipment, match the jack colors (Video = yellow, Audio Left = white, and Audio Right = red).

How to use

1. Select the input source by using the **TV/AV** button on the remote control.
2. Operate the corresponding external equipment. Refer to external equipment operating guide.

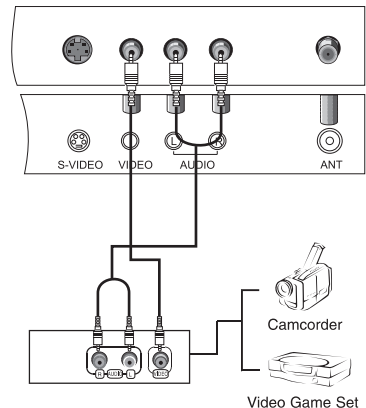

Basic Operating Instructions

Turn on the LCD-TV

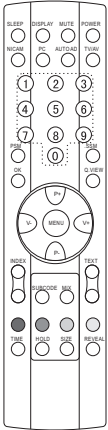

When the **POWER** button is pressed and the LCD-TV is turned on, the indicator light on the front of the LCD-TV changes from red to green. When the LCD-TV is turned on, the input mode is displayed on the screen. When the LCD-TV is turned off using the power button, the LCD-TV will go into standby mode and the indicator light turns red.

Note:
The display of the input mode will disappear in 3 seconds.

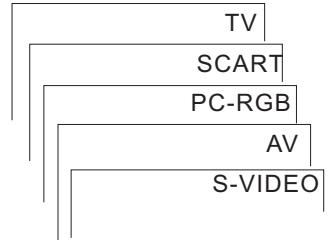

Switch Among Different Inputs: TV / SCART / PC-RGB / AV / S-VIDEO

Press the TV/AV button to select the input mode you want. Each time you press the TV/AV button, TV, SCART, PC-RGB, AV, S-VIDEO, will appear on the screen in the order.

Note:
The display of the input mode will disappear in 3 seconds.

Audio Control

1. Press the **V+** button to increase the volume. A number will appear on screen indicating the volume level.
2. Press the **V-** button to decrease the volume. A number will appear on screen indicating the volume level.

Mute

1. Press the **MUTE** button to mute the sound temporarily. A mute icon appears on the screen.
2. Press the **MUTE** button or **V+** again to restore the sound. The mute icon disappears.

Note: when you cut off the power supply completely, the mute function is cancelled automatically. But if the TV is switched to standby mode, the mute function cannot be cancelled. When you press **MUTE** to cancel the sound, if you press **V-** button, the level of the sound will be decreased, but the sound is still mute. In this condition, when you press **MUTE** again, the sound will restore the level you have decrease just.

Basic Operating Instructions

Select the TV Channel You Want

You can use the number keys on the remote control to directly select TV channels.

The LCD-TV can store up to 100 channels , and you can press the keys on the remote control or on the panel to make a selection.

1.Press the relevant key on the remote control if you want to choose any channel from 0 to 9. (for example: if you want to choose channel 8, just press the key number 0 and 8.)

Note: You must press 0 first and then the other numbers from 0 to 9 if you want To choose channels from 0 to 9)

2.If you want to choose a channel bigger than 9, please enter the two digits of the channel number you want to watch within 3 seconds. (for example: select channel 16)

Picture Mode

Press PSM button on the remote control for menu display . For desired mode as follows:

PERSONAL→ STANDARD→ MILD→ FRESH

TELETEXT

Some menu related function are not available in TELETEXT mode. MENU and AUTO AD control functions are not available in TELETEXT mode. If the TV is switched on by POWER after off in TELETEXT mode, or press TV/AV or PC button, the TELETEXT mode will disappear automatically.

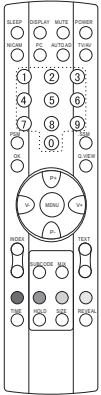

Teletext features may vary depending on the Broadcasting Companies and is only available if the channel selected is transmitting Teletext. Pressing the TEXT button whilst in Teletext operation will switch the current status to TV. When in Teletext mode, the volume may still be altered to the desired listening level.

Page Selection

Pages can be selected in two ways:

- Press **P+** or **P-** button to increase or decrease the page number by one.
- By entering the page number, using the number keys on the remote control.

SIZE Button

Press SIZE button to change display size : normal→large top→large bottom→normal

REVEAL Button

Press REVEAL to reveal hidden words e.g. Quiz page answers . Press again to hide.

Red/Green/ Yellow/Cyan Buttons

These four buttons correspond to the differently colored subjects .

HOLD Button

Press HOLD button to remain the Teletext page when viewing multi-page information .

INDEX Button

Press INDEX button to return to the main index page .

Depending on the way information is transmitted , this may have to be pressed more than once to return to the main index page .

TELETEXT

SUBCODE Button

When Teletext information exceeds more than one page , it may take some time for the automatic changing of the sub pages to reach the sub page you require . It is possible to enter your required sub page and continue watching the normal programme until the correct sub page is found .

Select the required page number using buttons 0-9 .

If the top of the page indicates that sub pages are being transmitted yet the page does not change . Then the number at the top of the page is there to indicate that the broadcaster has updated the page' s contents , there are no sub pages . Press SUBCODE button , page number/--- will be displayed at the bottom right of the screen.

Enter desired sub page number before the page number/--- disappears . To select page 6 enter 0,0,0 and 6 .

TEXT Button

Press TEXT to enter Teletext mode and only the text page can be visible .

MIX Button

Press MIX button to enter Teletext mode and both the TV picture and text page can be visible.

TIME

While in normal TV mode only, pressing the button **TIME** will display the teletext time in the top right corner for a few seconds.

Menu Operations

* In this manual, the OSD(On Screen Display) may be different from your TV' s because it is just an example to help you with the TV operation.

1. Press **MENU** button to either display the “PC MENU” or “TV MENU” or “VIDEO MENU” or “GENERAL MENU” or “AUDIO MENU” in different source inputs.
2. Press **P+/P-** to scroll through the parameters
3. Press **V+/V-** buttons to make changes to the parameters
4. Press the **OK** button to exit the menu

Picture Menu Options

Picture quality can be adjusted for any input separately .

The picture quality on the screen can be adjusted as follows:

1. Press **MENU** button until the following menu appears on the screen.

PC MENU

PC MENU	
BRIGHTNESS	50
CONTRAST	50
COLOR SETTING	9300K
AUTO CONFIG	→
H-POSITION	50
V-POSITION	50
PHASE	50
CLOCK	50



AV/S-VIDEO MENU

VIDEO MENU	
BRIGHTNESS	50
CONTRAST	50
COLOR	50
HUE	50
SHARPNESS	50



Menu Operations

Picture Menu Options Continued

TV MENU

VIDEO MENU	
BRIGHTNESS	50
CONTRAST	50
COLOR	50
HUE	50
SHARPNESS	50



2. Press **P+/P-** button to enter the picture menu and to go up and down to select the desired option .
3. Press **V+/V-** button to increase and decrease the level to adjust the selected option to your preference .
4. Repeat step 2 and step 3 until desired picture quality has been achieved .

Function:

BRIGHTNESS :Adjust the brightness of the picture . By increasing the level, it will add more light to dark parts of the picture and by decreasing the level ,it will add more dark to light parts of the picture.

CONTRAST :Adjust the contrast of the picture . The image becomes higher as the number increase.

COLOR SETTING : Press **V+/V-** to select between 9300K/6500K/USER define . You could adjust the color values in USER mode . And the menu display as follows:

USER COLOR SETTING	
RED	100
GREEN	100
BLUE	100



AUTO CONFIG : Is opted for adjustment of picture location frequency and phase parameters .

H-POSITION : Picture horizontal adjust

V-POSITION : Picture vertical position adjust .

Menu Operations

Picture Menu Options Continued

PHASE : Removes any horizontal distortion and clears or sharpness the displayed characters .

CLOCK : Adjust the TFT-LCD to match the PC-RGB input source

COLOR : Press **V+/V-** to adjust the color

HUE : Adjust the tone of the picture . Appear and be adjusted only under NTSC mode

SHARPNESS : Adjust the amount of the detail enhancement , the image sharpness rises as the number increases (By increasing the level, it will show cleaner and clearer images and by decreasing the level, it will make picture smoother).

Sound Menu Options

Sound can be adjusted for any input as follows:

1. Press **MENU** button until the following menu appears on the screen

AUDIO MENU	
VOLUME	50
BALANCE	50
AUDIO PRESET	PERSONAL
TREBLE	50
BASS	50
AVL	ON



You can adjust sound options **BALANCE**, **TREBLE**, and **BASS** to the levels you prefer.

2. Press **P+/P-** button to enter the audio menu and to go up and down to select the desired option .

3. Press **V+/V-** button to increase and decrease the level to adjust the selected option to your preference .

4. Repeat step 2 and step 3 until desired audio quality has been achieved ..

Menu Operations

Sound Menu Options Continued

Function :

VOLUME : Adjust the volume of your TV

BALANCE : Adjust the balance of the audio output from left to right . When indication value of balance increases toward 100 , sound of the left speaker becomes weaker . When indication value of balance decreases toward 0 , sound of the right speaker become weaker .

AUDIO PRESET : Press **V+/V-** to select between PERSONAL, VOICE, MUSIC and THEATER .

TREBLE : Adjust the treble of the sound . Can only be adjust under PERSONAL mode .

BASS : Adjust the bass of the sound . Can only be adjust under PERSONAL mode .

AVL: Select ON to adjust the volume level automatically.

General Menu Options

Menu Language Selection:

The menus can be shown on the screen in the selected language. First select your language.

1. Press the **MENU** button until the GENERAL MENU appears on the screen .
2. Press **P+/P-** button to select LANGUAGE.
3. Press **V+/V-** button to select your desired language.

From this point on, the on-screen menus will be shown in the language of your choice.

GENERAL MENU	
LANGUAGE	ENGLISH
BLUE SCREEN	ON
NOISE REDUCE	OFF
INPUT SOURCE	TV
TXT LANGUAGE	PAN EUROPEAN
TXT EAST/WEST	EAST
RESET	→

Menu Operations

General Menu Options Continued

1. Press **MENU** button until the following menu appears on the screen

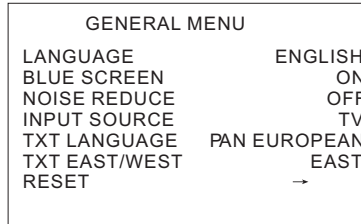

You can adjust sound options BLUE SCREEN , NOISE REDUCE, INPUT SOURCE and RESET to the levels you prefer.

2. Press **P+/P-** button to enter the general menu and to go up and down to select the desired option .
3. Press **V+/V-** button to adjust the selected option to your preference .
4. Repeat step 2 and step 3 until desired quality has been achieved ..

Functions:

1. BLUE SCREEN : You can set it ON or OFF . If select ON and there is no signal , the screen will display blue screen
2. NOISE REDUCE : select OFF/LOW/MID/HIGH to reduce the noise of the picture , provide clearer picture . (The effect is more and more distinctness if you select in sequence as follows: OFF, LOW, MID, HIGH.)
3. INPUT SOURCE : Display current mode . There are PC-RGB , AV , S-VIDEO , TV , SCART to display .
4. TXT LANGUAGE: To switch the teletext languages.
5. TXTEAST/WEST: To select EAST or WEST .
6. RESET : Press **V+** to reset some settings to the factory default .

Menu Operations

TV Menu Options

1. Press **MENU** button until the following menu appears on the screen

TV MENU	
CHANNEL	1
SYSTEM	DK
SKIP	OFF
AFC	ON
FINE TUNE	448.25MHz
SWAP	→
MANUAL SEARCH	→
AUTO SEARCH	→

Note: This menu is only appears in TV mode.

2. Press **P+/P-** button to enter the TV menu and to go up and down to select the desired option .
3. Press **V+/V-** button to adjust the selected option to your preference .
4. Repeat step 2 and step 3 until desired picture quality has been achieved ..

Functions:

1. CHANNEL : Press **V+/V-** to change the TV channel .
2. SYSTEM : Select the TV standard system from DK,I,L,BG
3. SKIP : If you want skip a channel , press **V+/V-** to select ON , and this channel will be skip next time when you press **P+/P-** . But you can press digits button to select the channel . If you want to restore the channel , select OFF .
4. AFC: Auto frequency control . Select ON to improve the image quality .
5. FINE TUNE : If the image received is not very good , you can press **P+/P-** to select FINE TURN item in menu . Then , press **V+/V-** button to adjust and improve the image quality .

Menu Operations

TV Menu Options Continued

6. SWAP : Press **V+** to display the menu as follows:

FROM :	1
TO :	9
SWAP	→

Press **P+/-** to select the item and then **V+/-** to adjust the channel and **V+** to confirm. (For example: press **P+/-** to select FROM item, and then press **V+/-** to adjust the channel number to 1; then Press **P+/-** to select TO item, and **V+/-** to adjust the channel number to 9; press **P+/-** to select SWAP item, and then **V+** to confirm. The two channels will be exchanged)

7. MANUAL SEARCH : Press **V+** to start to search the channel . The following menu will display on the screen:

DOWN	UP
543.25MHz	
	

Press **P+/-** or **V+/-** to select DOWN or UP , and then press **MENU** to confirm. (If you select DOWN, the search will search the lower frequency channel and UP will search the higher frequency channel)

7. AUTO SEARCH : Auto search and save the channel .press **V+** to start to search the channel and the following menu will appears on the screen :

AUTO SEARCH	
SECAM L	
NO	YES

Press **P+/-** to select SECAM L , and **V+/-** to adjust between SECAM L and BG/DK/I system.

Press **P+/-** to select NO or YES, and **MENU** to confirm. Then the TV will start to search as follows:

AUTO SEARCH	
PLEASE WAIT	
	
11	190.65MHz

You could press **MENU** to stop the search .

Specifications

Specifications of the television that you have just purchased may vary from the information in this table due to technical innovations.

Picture, sound system	PAL/SECAM-B/G,I,D/K,L,L'
Antenna input impedance	75Ω
Audio output	≥1.5W+1.5W
External input port	AV input PC input S-VIDEO input PC audio input SCART input 12V DC input Antenna input
AC-DC adapter	Input: ~100-240V 50/60Hz, Output: ≍ 12V
Temperature	Working:5°C~35°C Storage:-15°C~45°C

NOTE:Sound system L' certainly does not demonstrate in the TV's OSD, in menu L includes sound system L and sound system L'.

Accessories

- | | | |
|-----------------|------------------|-----------------|
| 1 AC-DC adapter | 3 Remote control | 5 Batteries |
| 2 AC cable | 4 Owner's Manual | 6 Warranty card |

Note: Warranty card is only for the special countries and areas

● Note:

All specifications are subject to change without notice.
All quality are approximate value.



V0.2
0090506259

Free Manuals Download Website

<http://myh66.com>

<http://usermanuals.us>

<http://www.somanuals.com>

<http://www.4manuals.cc>

<http://www.manual-lib.com>

<http://www.404manual.com>

<http://www.luxmanual.com>

<http://aubethermostatmanual.com>

Golf course search by state

<http://golfingnear.com>

Email search by domain

<http://emailbydomain.com>

Auto manuals search

<http://auto.somanuals.com>

TV manuals search

<http://tv.somanuals.com>