

Haier

*LCD TV
OWNER'S MANUAL*

*MODEL: L19M3
L22M3
L24M3*

Haier

Please READ this manual carefully
before operating your TV, and retain
it for future reference





Contents

1、	Safety and warnings.....	2-3
2、	Introduction.....	4
3、	Installation.....	5-11
4、	Remote Controller.....	12
5、	TV Operation.....	13-15
6、	Trouble shooting.....	16

IMPORTANT SAFETY INSTRUCTION

- 1) Read these instructions.
- 2) Keep these instructions.
- 3) Heed all warnings.
- 4) Follow all instructions.
- 5) Do not use this apparatus near water.
- 6) Clean only with dry cloth.
- 7) Do not block any ventilation openings, install in accordance with the instructions.
- 8) Do not install near any heat sources such as radiations, heat registers, stoves, or other apparatus (including amplifiers) that produce heat.
- 9) Do not defeat the safety purpose of the polarized plug. If the provided plug does not fit into your outlet, consult an electrician for replacement of the obsolete outlet.
- 10) Protected the power cord from being walked on or pinched particularly at plugs, convenience receptacles, and the point where they exit from the apparatus.
- 11) Only use attachments/accessories specified by the manufacturer.
- 12) Unplug this apparatus during lightning storms or when unused for long periods of time.
- 13) Refer all servicing to qualified service personnel. Servicing is required when the apparatus has been damaged in any way, such as power-supply cord or plug is damaged, liquid has been spilled or objects have fallen into the apparatus, the apparatus has been exposed to rain or moisture, does not operate normally, or has been dropped.
- 14) Mains plug is used as the disconnect device, the disconnect device shall remain readily operable.
- 15) The ventilation should not be impeded by covering the ventilation openings with items, such as newspapers, table-cloth, curtains, etc.
- 16) No naked flame sources, such as lighted candles, should be placed on the apparatus.
- 17) Attention should be drawn to the environmental aspects of battery disposal.
- 18) The use of apparatus in moderate climate.
- 19) The apparatus shall not be exposed to dripping or splashing and that no objects filled with liquids, such as vases, shall be placed on the apparatus.

 <div style="display: inline-block; border: 1px solid black; padding: 2px; text-align: center; font-size: 8px;"> CAUTION RISK OF ELECTRIC SHOCK DO NOT OPEN! </div> 
<p>CAUTION</p> <p>TO REDUCE THE RISK OF ELECTRIC SHOCK, DO NOT REMOVE COVER (OR BACK). NO USER SERVICEABLE PARTS INSIDE. REFER SERVICING TO QUALIFIED SERVICE PERSONNEL.</p>

 The symbol indicates that dangerous voltages constituting a risk of electric shock are present within this unit.

 The symbol indicates that there are important operating and maintenance instructions in the literature accompanying this unit.

WARNING:

To reduce the risk of fire or electric shock, do not expose this apparatus to rain or moisture.

WARNING:

The batteries shall not be exposed to excessive heat such as sunshine, fire or the like.



This symbol indicates that this product incorporates double insulation between hazardous mains voltage and user accessible parts. When servicing use only identical replacement parts.



This marking indicates that this product should not be disposed with other household wastes throughout the EU. To prevent possible harm to the environment or human health from uncontrolled waste disposal, recycle it responsibly to promote the sustainable reuse of material resources. To return your used device, please use the return and collection systems or contact the retailer where the product was purchased. They can take this product for environmental safe recycling.

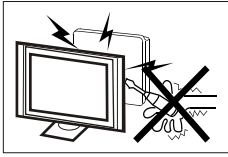

High voltages are used in the operation of this television receiver. Do not remove the cabinet back from your set. Refer servicing to qualified service personnel.

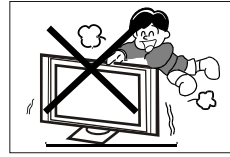

Never stand on, lean on, or suddenly push the television or its stand. You should pay special attention to children. Serious injury may result if it falls.

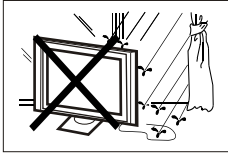

To prevent fire or electrical shock hazard, do not expose the television receiver to rain or moisture.

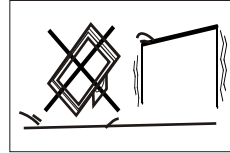

Do not place your television on an unstable cart, stand, shelf or table. Serious injury to an individual, and damage to the television, may result if it falls.



Do not drop or push objects into the television cabinet slots or openings. Never spill any kind of liquid on the television receiver.

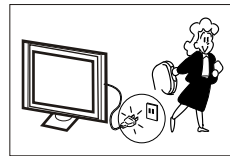

When the television receiver is not used for an extended period of time, it is advisable to disconnect the AC power cord from the AC outlet.

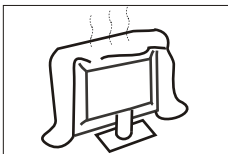

Do not block the ventilation holes in the back cover. Adequate ventilation is essential to prevent failure of electrical components.

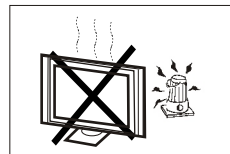

Avoid exposing the television receiver to direct sunlight and other sources of heat. Do not stand the television receiver directly on other products which give off heat, e.g. video cassette players and audio amplifiers. Do not place naked flame sources, such as lighted candles on the television.

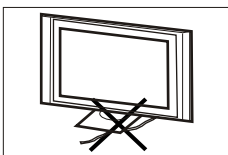

Do not trap the power supply cord under the television receiver.

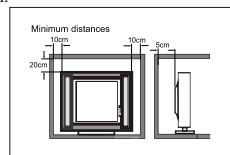

If the television is to be built into a compartment or similar enclosure, the minimum distances must be maintained. Heat build-up can reduce the service life of your television, and can also be dangerous.

Main features

- ① Used as Television, display terminal, PC display;
- ② High luminance, wide viewing angle;
- ③ Can store 100 TV programs;
- ④ HDMI interface;
- ⑤ Multi-Media player (USB);

Accessories

- Infrared Remote Controller..... 1
- Battery(AAA).....2
- User's Manual..... 1
- AV2IN/AVOUT cord.....1

Main parameter

Viewing Picture Size (Diagonal)	18.5 inch	21.6 inch	23.6 inch
Resolution	1366x768	1366x768	1920x1080
Aspect Ratio	16 : 9	16 : 9	16 : 9
TV System	PAL/BG	PAL/BG	PAL/BG
Video Signal System	PAL/NTSC/SECAM	PAL/NTSC/SECAM	PAL/NTSC/SECAM
Receiving Channel	1-100	1-100	1-100
Input Power Voltage	AC 100-240V~50/60Hz	AC 100-240V~50/60Hz	AC 100-240V~50/60Hz
Power consumption	30W	60W	60W
Audio Output Power (THD≤7%)	2 x 3W	2 x 3W	2 x 3W
Signal Input	Analog RGB(VGA) x 1 High-Definition Multimedia Interface (HDMI) x 2 Composite Video Input x 2 Composite Video output x 1 Audio Input x 3 YCb (Pb)Cr (Pr) x 1 USB x 1 RF x 1		
Horizontal definition (TV line)	Composite Video input ≥350 Y Cb(Pb) Cr(Pr) ≥400		

Front panel (L19M3)

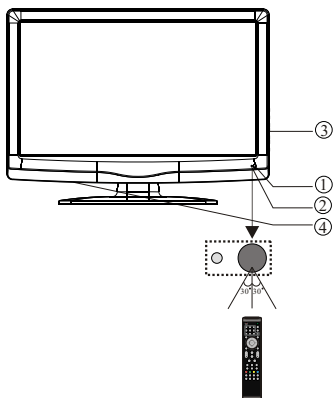

- 1: Remote control sensor.
- 2: Indicator LED: GREEN ● POWER ON.
RED ● STANDBY.
- 3: Side buttons
- 4: Power button: Press the Power Button to turn the unit on or off.

Front panel (L22M3/L24M3)

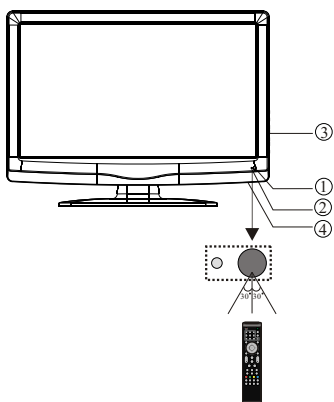

- 1: Remote control sensor.
- 2: Indicator LED: GREEN ● POWER ON.
RED ● STANDBY.
- 3: Side buttons
- 4: Power button: Press the Power Button to turn the unit on or off.

KEYBOARD (L19M3/L22M3/L24M3)

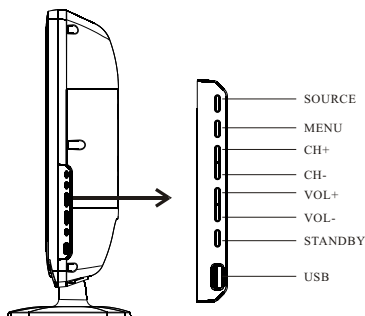

1. **SOURCE:**
Display the input source menu.
2. **MENU:**
Display main MENU.
3. **CH+/CH-**
In TV mode, press "CH+" or "CH-" to change the channel up and down.
In MENU mode, press "CH+" or "CH-" to select items.
In standby mode, press "CH+" or "CH-" to turn on the TV.
4. **VOL+/VOL-**
Adjust sound level.
In MENU mode, press "VOL+" or "VOL-" to adjust the item that you selected.
5. **STANDBY**
Press this button to turn the unit ON from STANDBY mode.
Press it again to turn the set back to STANDBY.
6. **USB**
The USB memory stick should be plug in the unit directly. USB extension cable should not be used to avoid failing of data transferring and interference caused.

REAR AV PASTER (L19M3)

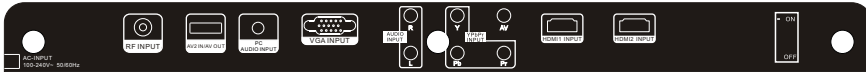

All the terminals are (from left to right):

AC POWER SOCKET, ANTENNA, AV2 IN/AV OUT, PC AUDIO INPUT, VGA, AUDIO INPUT, YPbPr, AV INPUT, HDMI 1, HDMI 2, POWER SWITCH.

Note: 1. AV and YPbPr share one audio channel.

2. When HDMI 1 port get DVI signal, the "PC Audio" channel is changed to receive the audio for HDMI 1 port.

REAR AV PASTER (L22M3)



All the terminals are (from left to right):

AC POWER SOCKET, HDMI 1, HDMI 2, AV, YPbPr, AUDIO INPUT, VGA, PC AUDIO INPUT, AV2 IN/AV OUT, ANTENNA.

Note: 1. AV and YPbPr share one audio channel.

2. When HDMI 1 port get DVI signal, the "PC Audio" channel is changed to receive the audio for HDMI 1 port.

REAR AV PASTER (L24M3)



All the terminals are (from left to right):

AC POWER SOCKET, HDMI 1, HDMI 2, AV, YPbPr, AUDIO INPUT, VGA, PC AUDIO INPUT, AV2 IN/AV OUT, ANTENNA.

Note: 1. AV and YPbPr share one audio channel.

2. When HDMI 1 port get DVI signal, the "PC Audio" channel is changed to receive the audio for HDMI 1 port.

ANTENNA

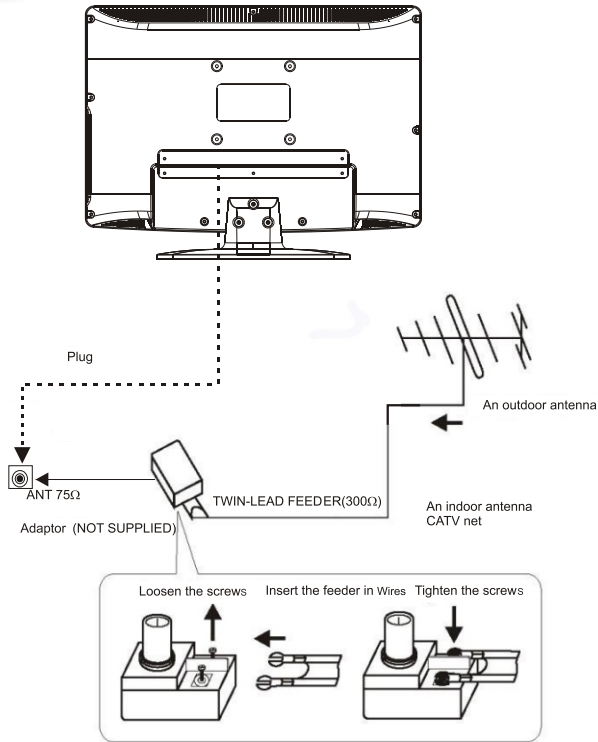

Note:
 Aerial connections: IEC (female).
 Input impedance: 75Ω unbalanced.

PC

STEPS:
 Be sure both the TV and computer are Power off.
 1. Connect VGA and audio cable
 2. Connect power cord
 3. Power on the TV, switch to PC mode
 4. Power on the PC
 This sequence is very important.

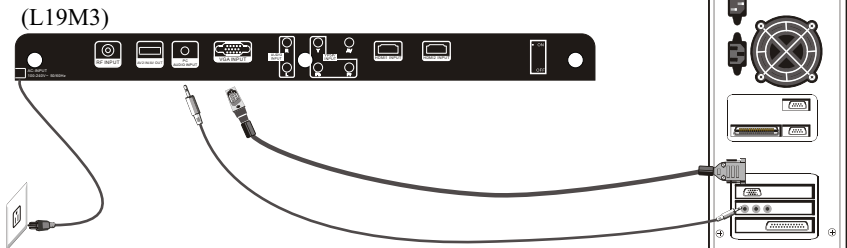

(L22M3)

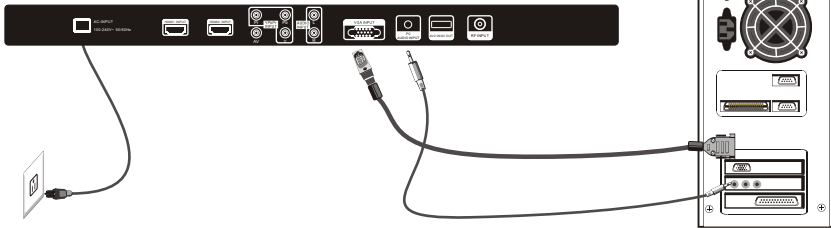

(L24M3)

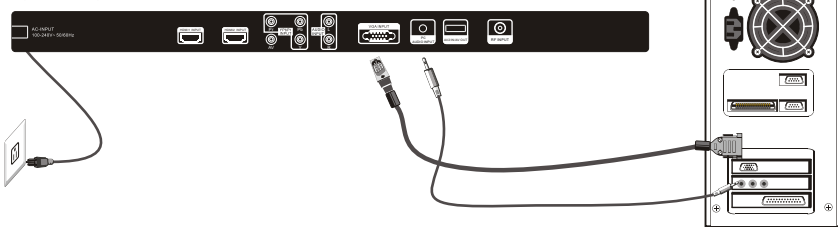

PRESET MODE (PC)

	RESOLUTION	V.Freq.(Hz)	H.Freq.(KHz)
1	800*600	60	37.88
2	1024*768	60	48.36
3	1360*768 (Only for 19", 22")	60	47.7
4	1280*768 (Only for 24")	60	47.3
5	1920*1080 (Only for 24")	60	67.5

NOTE: PC V.Freq.(Hz) not more than 60Hz.

PRESET MODE (HDMI)

	RESOLUTION	V.Freq.(Hz)	H.Freq.(KHz)
1	800*600	60	37.88
2	1024*768	60	48.36
3	1360*768	60	47.7
4	1280*768	60	47.3
5	1920*1080	60	67.5

AV EQUIPMENT (L19M3)

This TV provides two groups of AV, one group of YPbPr for convenient connection to VCR, DVD or other video equipment. Please refer to the owner's manual of the equipment to be connected as well.

You can use the input terminals on TV set rear as follows.

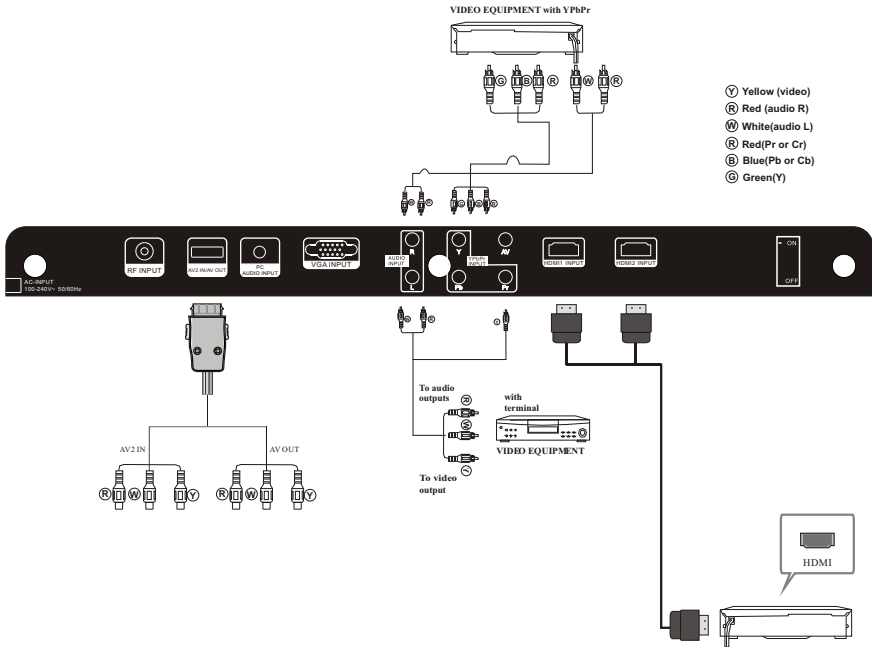

It can be connected to the following appliances: VCR, multi disc player, DVD, camcorder, video game or stereo system, etc.....

YPbPr can support these video fomats: 480i, 576i, 480p, 576p, 720p, 1080i, 1080p.

- Note:
1. AV and YPbPr share one audio channel.
 2. When HDMI 1 port get DVI signal, the "PC Audio" channel is changed to receive the audio for HDMI1 port.
 3. Sometimes it will not support in different device because the device supplys nonstandard signal.
 4. When current source is TV, AV OUT signal is TV; when current source is AV, AV OUT signal is AV; other sources have no AV OUT signal.

AV EQUIPMENT (L22M3)

This TV provides two groups of AV, one group of YPbPr for convenient connection to VCR, DVD or other video equipment. Please refer to the owner's manual of the equipment to be connected as well.

You can use the input terminals on TV set rear as follows.

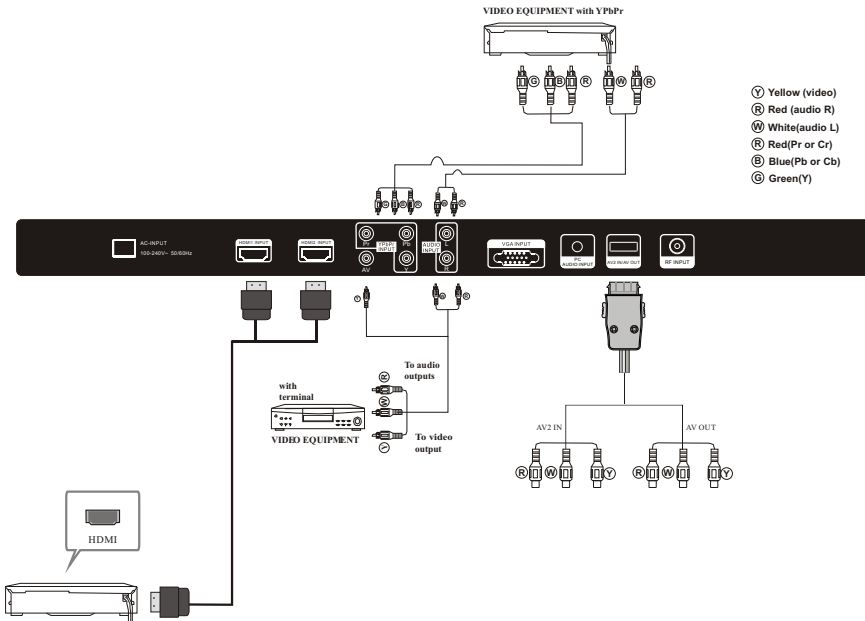

It can be connected to the following appliances: VCR, multi disc player, DVD, camcorder, video game or stereo system, etc.....

YPbPr can support these video fomats: 480i, 576i, 480p, 576p, 720p, 1080i, 1080p.

- Note:
1. AV and YPbPr share one audio channel.
 2. When HDMI 1 port get DVI signal, the "PC Audio" channel is changed to receive the audio for HDMI1 port.
 3. Sometimes it will not support in different device because the device supplys nonstandard signal.
 4. When current source is TV, AV OUT signal is TV; when current source is AV, AV OUT signal is AV; other sources have no AV OUT signal.

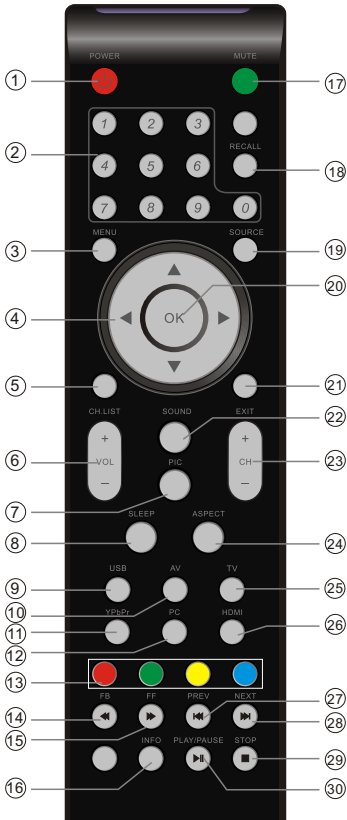

1:POWER

To set the TV to standby or power on.

2:NUMBER KEY

For direct access to channels.

3:MENU

To display the menu.

4:CURSOR

To move within the menu.

5:CH. LIST

To display the channel list.

6:VOL+/-

To adjust the sound level.

7:PIC

To switch the picture mode.

8:SLEEP

Set the time to turn off the TV.

9, 10, 11, 12, 25, 26:

SOURCE HOT KEYS

Switch to the source that you want directly.

13:Be used in programme edit:

Red: delete

Green: rename

Yellow: move

Blue: skip

14:FB

Fast backward key.

15:FF

Fast forward key.

16:Info

Displays or removes the signal information.

17:MUTE

To disable or enable the sound.

18:RECALL

To access the previously viewed programme.

19:SOURCE

To display source menu.

20:OK

In menu mode, use this key to confirm.

21:EXIT

Used to return to the previous menu or exit menu.

22:SOUND

To switch sound mode.

23:CH+/CH-

To access the next or previous TV Program.

24:ASPECT

To change the picture aspect ratio: 16:9 or 4:3.

27:PREV

Next key.

28:NEXT

Previous key.

29:STOP

Stop key.

30:PLAY/PAUSE

Play / Pause key.

Insert Batteries Into the Remote Control

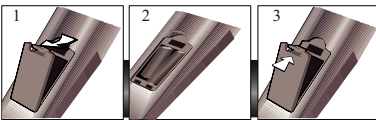

1. Remove the battery cover.
2. Inserting the 2 AAA 1.5V batteries making sure the polarity (+ or -) of the batteries matches the polarity marks inside the unit.
3. Mount the battery cover.
Replace with new batteries when the TV set begins to show the following symptoms:
Operation is unsteady or erratic. Sometimes the TV set does not function with Remote Control Unit.

Remark:

- 1) Alkaline Battery Recommended.
- 2) Remove batteries when they are exhausted or if the remote control is not to be used for long time.

1. CHANNEL MENU

The first item of the MENU is channel menu (for TV source only). You can search channels and edit programs here. Press ▼▲ to move, press OK button to confirm, and press ◀▶ to adjust.

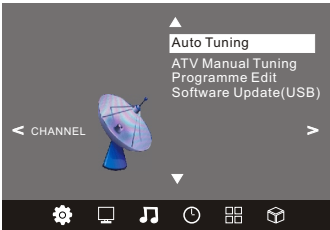

1).Auto tuning:

Search all the TV channels automatically.

2). Manual tuning:

You can change the sound system to search the TV channels and fine tune the channels, then storage the channels you selected.

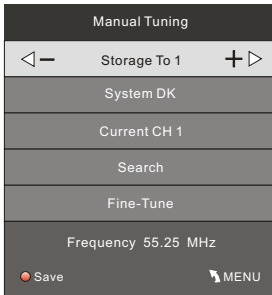

NOTE:

Press teletext red button to storage to channels after manual tuning.

3). Program Edit:

You can Delete, Rename, Move, or Skip any programs.

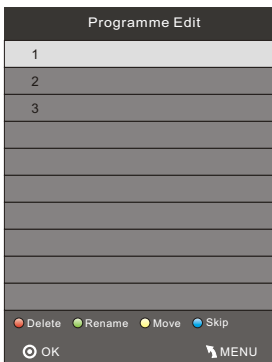

Delete

Press teletext red button, it will shows red delete cursor. Press ▼▲ to choose the program. Press red button again, the program will delete.

Rename

Move the cursor to the program, press teletext green button to rename the program. Press ▼▲ to choose the character. Press ◀▶ to move the cursor. Press MENU button to exit edit, Press EXIT to exit the menu. Note: The TV programs name only can be 5 characters.

Move

Move the cursor to the program, press teletext yellow button, it will show yellow cursor, Press ▼▲ to move the program.

Skip

Press ▼▲ to choose the program, press teletext blue button to skip this program, The icon Ⓢ will show on the right side of the program. Choose the skipped program, press the blue button again, you can cancel the skip, Then the icon Ⓢ will disappear.

4). Software update(USB):

Update the TV set' s software by USB.

2. PICTURE MENU

The second item of the MENU is PICTURE MENU. You can adjust picture effect here, such as contrast, brightness, etc. Press ▼▲ to move, press OK button to confirm, and press ◀▶ to adjust.

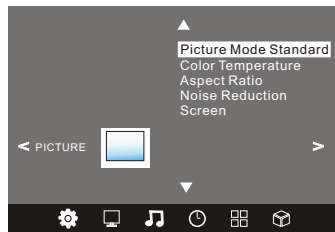

NOTE:

- 1).Tint is available in NTSC system only.
- 2).There are four color temperature modes can be selected, such as medium, warm, cool, and user.
- 3).Screen is available in PC mode only, which can adjust horizontal position, vertical position, size and phase.

3. SOUND MENU

The third item of the MENU is the SOUND MENU.

You can adjust the sound effect here such as treble, bass, balance etc. Press $\blacktriangledown/\blacktriangle$ to move, press OK button to confirm, and press $\blacktriangleleft/\blacktriangleright$ to adjust.

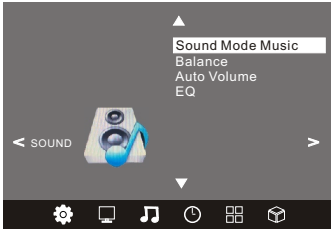

Note:

Auto volume: only available when the input signal volume is too large or distortion.
EQ: Amplify the selected sound frequency as you wish.

4. TIME MENU

The fourth item of the menu is the TIME MENU. You can adjust the clock, power on/off time, sleep time etc.

Press $\blacktriangledown/\blacktriangle$ to move, press OK button to confirm, and press $\blacktriangleleft/\blacktriangleright$ to adjust.

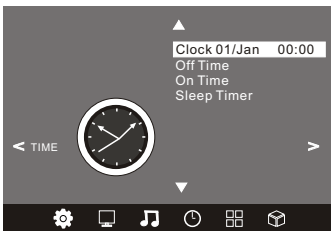

NOTE:

Within 15 minutes there is no signal, the TV will auto sleep.
Once you power off the TV set by AC, the clock time will be reset.

5. OPTION MENU

The fifth item of the MENU is the OPTION MENU. You can adjust the OSD language or Restore factory default.

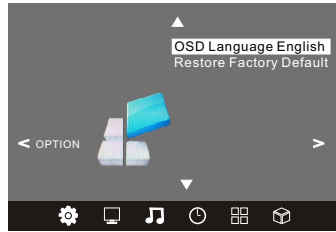

NOTE:

Restore factory default will clear all the programs and Reset all the settings to default value.

6. APPLICATION MENU

The sixth item of the MENU is the APPLICATION MENU.

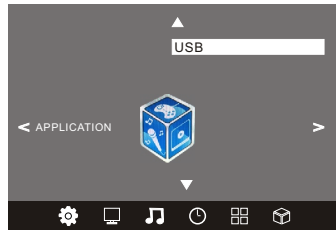

Press OK button to enter the USB menu.

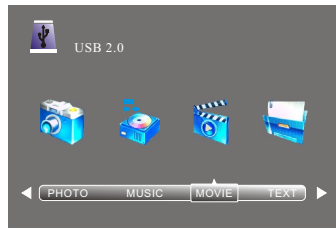

Please make sure that the USB device has been plugged into the slot. There are four type media items that can be selected, such as photo, music, Movie and text. Select the type media item by pressing $\blacktriangleleft/\blacktriangleright$, press OK button to enter the disk selection menu.

In the movie mode, when you use FB, FF function, the audio may be pause in several seconds to synchronize the audio signal and video signal.

In text mode, press $\blacktriangleleft/\blacktriangleright$ to make page up and page down.

NOTE:

When the USB device isn't supported, it may be that the power of the USB device isn't enough.

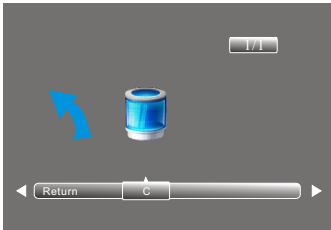

Press the ◀▶ to select the right disk and press OK to display media files and folder list or choose Return to back to the media type selection menu.

Press ◀▶ to select the function icon, press OK button to confirm the function.

Press ▼ or EXIT button to exit the control bar.

NOTE:

You can adjust the audio track, subtitle, or program in the Info menu while Playing the video file. Choose the Info icon and press OK can display the Info MENU.

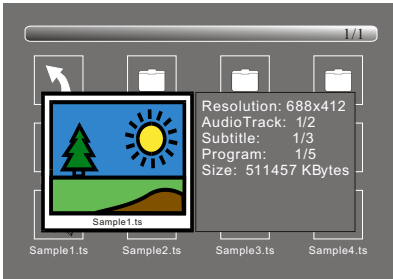















Select the media file by pressing ◀▶ or ▼▲, then the preview frame will pop up. Press the ▶ button to play the media file in full screen. When the media file (photo, music, Movie or text type) is playing, press the OK or Info button can display the control bar.

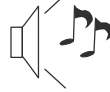
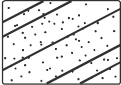

Music function need to put music and picture in the same folder.



Trouble phenomenon		Inspection
Picture	Audio	
 <p>Snow</p>	 <p>Noise</p>	antenna position, direction or connection
 <p>Ghost</p>	 <p>Normal audio</p>	antenna position, direction or connection
 <p>Interfere</p>	 <p>Noise</p>	electronic equipment, car/ motorcycle, fluorescent light
 <p>Normal Picture</p>	 <p>Mute</p>	Volume (inspect whether the mute function on the remote control are started, or audio system are correct or not)
 <p>No picture</p>	 <p>Mute</p>	Power cord is not inserted Power switch is not opened Contrast and brightness/volume setup Press standby key on the remote control for inspecting
 <p>No color</p>	 <p>Normal audio</p>	color control
 <p>Scramble</p>	 <p>Normal audio or weak</p>	retune channel
 <p>No color</p>	 <p>Noise</p>	Audio system

Special Explanation: The accessories such as remote control is not belongs to the guarantee.

Free Manuals Download Website

<http://myh66.com>

<http://usermanuals.us>

<http://www.somanuals.com>

<http://www.4manuals.cc>

<http://www.manual-lib.com>

<http://www.404manual.com>

<http://www.luxmanual.com>

<http://aubethermostatmanual.com>

Golf course search by state

<http://golfingnear.com>

Email search by domain

<http://emailbydomain.com>

Auto manuals search

<http://auto.somanuals.com>

TV manuals search

<http://tv.somanuals.com>