

LED Television

User Manual
MODELS:
LE46F2280

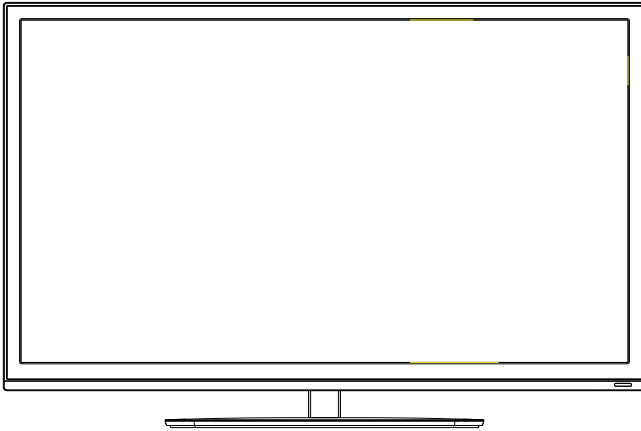

Haier[®]

SMARTER LIFE BETTER PLANET

Contents

Safety and warnings.....	2-3
Introduction.....	4
Base stand assembly.....	5
Installation.....	6-9
Remote Control.....	10
Operation.....	11-13
Troubleshooting.....	14
Warranty.....	15

IMPORTANT SAFETY INSTRUCTION

- 1) Read these instructions.
- 2) Keep these instructions.
- 3) Heed all warnings.
- 4) Follow all instructions.
- 5) Do not use this Television near water.
- 6) Clean only with dry cloth.
- 7) Do not block any ventilation openings, install in accordance with the instructions.
- 8) Do not install near any heat sources such as radiations, heat registers, stoves, or other Television (including amplifiers) that produce heat.
- 9) Do not defeat the safety purpose of the polarized plug. If the provided plug does not fit into your outlet, consult an electrician for replacement of the obsolete outlet.
- 10) Protected the power cord from being walked on or pinched particularly at plugs, convenience receptacles, and the point where they exit from the Television.
- 11) Only use attachments/accessories specified by the manufacturer.
- 12) Unplug this Television during lighting storms or when unused for long periods of time.
- 13) Refer all servicing to qualified service personnel. Servicing is required when the Television has been damaged in any way, such as; power-supply cord or plug is damaged, liquid has been spilled or objects have fallen into the Television, the Television has been exposed to rain or moisture, does not operate normally, or has been dropped.
- 14) Mains plug is used as the disconnect device, the disconnect device shall remain readily operable.
- 15) The ventilation should not be impeded by covering the ventilation openings with items, such as newspapers, table-cloth, curtains, etc.
- 16) No naked flame sources, such as lighted candles, should be placed on the Television.
- 17) Attention should be drawn to the environmental aspects of battery disposal.
- 18) The use of Television in moderate climate.
- 19) The Television shall not be exposed to dripping or splashing and that no objects filled with liquids, such as vases, shall be placed on the Television.



The symbol indicates that dangerous voltages constituting a risk of electric shock are present within this unit.



The symbol indicates that there are important operating and maintenance instructions in the literature accompanying this unit.

WARNING:

To reduce the risk of fire or electric shock, do not expose this Television to rain or moisture.

WARNING:

The batteries shall not be exposed to excessive heat such as sunshine, fire or the like.

WARNING:

The excessive sound pressure from earphones and headphones can cause hearing loss.



This symbol indicates that this product incorporates double insulation between hazardous mains voltage and user accessible parts. When servicing use only identical replacement parts.



This marking indicates that this product should not be disposed with other household wastes throughout the EU. To prevent possible harm to the environment or human health from uncontrolled waste disposal, recycle it responsibly to promote the sustainable reuse of material resources. To return your used device, please use the return and collection systems or contact the retailer where the product was purchased. They can take this product for environmental safe recycling.

Haier is committed to safely recycling electronic products and product materials. Please check for a local recycling location in the United States at: 1800RECYCLING.COM or call 1.800.RECYCLING.

	CAUTION RISK OF ELECTRIC SHOCK DO NOT OPEN!	
CAUTION		
TO REDUCE THE RISK OF ELECTRIC SHOCK, DO NOT REMOVE COVER (OR BACK). NO USER SERVICEABLE PARTS INSIDE. REFER SERVICING TO QUALIFIED SERVICE PERSONNEL.		

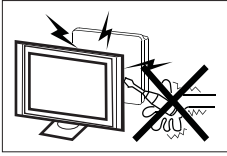

High voltages are used in the operation of this television receiver. Do not open the cabinet. Refer servicing to qualified service personnel.

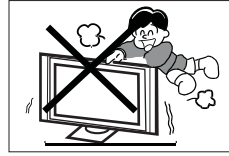

Never stand on, lean on, or suddenly push the television or its stand. You should pay special attention to children. Serious injury may result if it falls.

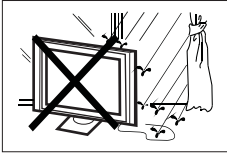

To prevent fire or electrical shock hazard, do not expose the television receiver to rain or moisture.

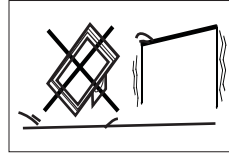

Do not place your television on an unstable cart, stand, shelf or table. Serious injury to an individual and/or damage to the television may result if it falls.



Do not drop or push objects into the television cabinet slots or openings. Never spill any kind of liquid on the television receiver.

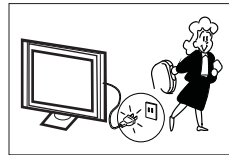

When the television receiver is not used for an extended period of time, it is advisable to disconnect the AC power cord from the AC outlet.

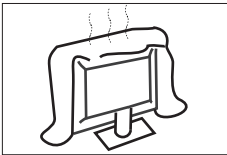

Do not block the ventilation holes on the back cover of the TV. Adequate ventilation is essential to prevent failure of electrical components.

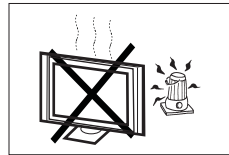

Avoid exposing the television receiver to direct sunlight and other sources of heat. Do not stand the television receiver directly on other products which give off heat, e.g. video cassette players and audio amplifiers. Do not place naked flame sources, such as lighted candles on or near the television.

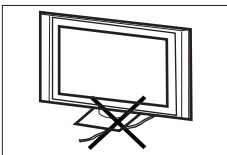

Do not trap the power supply cord under the television receiver's stand.

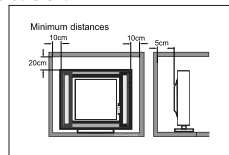

If the television is to be built into a compartment or similar enclosure, the minimum distances must be maintained. Heat build-up can reduce the life of your television, and can also be dangerous.

Main features

- Integrated ATSC TV tuner for HDTV broadcast reception
- High brightness provides a vivid and brilliant picture
- Deeper blacks and brighter whites with high contrast
- Wide Screen aspect ratio (16:9) for a complete home theater experience
- HDMI input for true digital connection
- VGA port for connection to PC
- Built-in stereo speaker system
- Full-function Remote Control

Accessories

Power cable.....	1
Infrared Remote Control.....	1
User's Manual	1
Battery(AAA).....	2

Main parameter

Viewing Picture Size (diagonal)	46 inches
Resolution:	1920 x 1080
Power supply	AC 100-240V 50/60Hz
Power consumption	98W
Audio Output Power (THD ≤ 7%):	2x8W
Aspect Ratio:	16:9
TV System:	ATSC Digital system and NTSC Analog system
Video Signal System:	NTSC
Receiving Channel:	Cable: 1-135 / Air: 2-69 (ATV&DTV)
High-Definition Multimedia Interface (HDMI) Input	x 2
Component (YPbPr) Input	x 1
Composite Video Input	x 1
Analog RGB (VGA) Input	x 1
Audio Input	x 2
Headphone Output	x 1
Coaxial Output	x 1
USB Input	x 1
Horizontal definition (TV line)	Composite Video Input ≥350 Video Input ≥400 Component (YPbPr) ≥400



HDMI, the HDMI logo and High-Definition Multimedia Interface are trademarks or registered trademarks of HDMI Licensing LLC.

Base Stand Assembly Instruction

1. Place the TV with the display side down on a flat surface. Use a cloth to protect the display. Position the base stand onto the bottom of the stand neck.

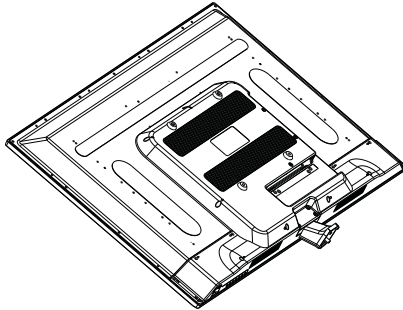

2. Attach the base stand to the stand neck firmly tightening the supplied screws.

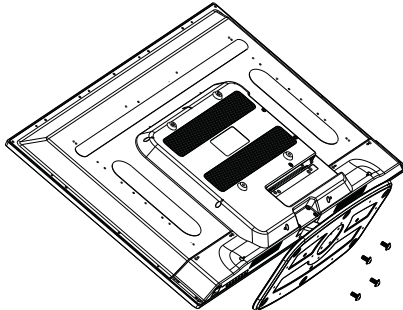

Note: This stand is not a swivel stand. Do not attempt to rotate the TV.

Front panel

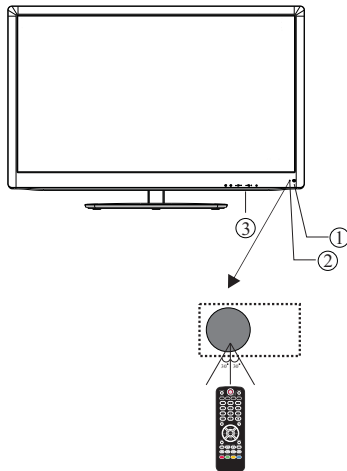

- 1: Remote control sensor.
- 2: Indicator LED: BLUE ● POWER ON.
RED ● STANDBY.
- 3: Panel keys

Side panel

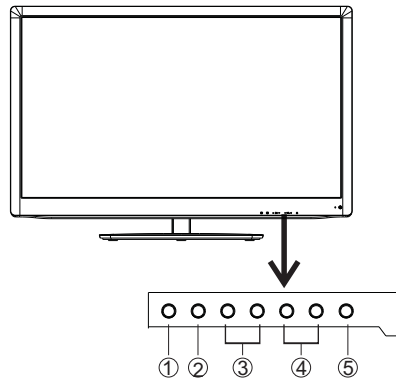

- 1. **SOURCE:** Display the input source menu.
- 2. **MENU:** Display main MENU.
- 3. **CH+/CH-:** In TV mode, press "CH+" or "CH-" to change the channel up and down. In MENU mode, press "CH+" or "CH-" to select items in standby mode, press "CH+" or "CH-" to turn on the TV.
- 4. **VOL+/VOL-:** Adjust sound level. In MENU mode, press "VOL+" or "VOL-" to adjust the item that you selected.
- 5. **STANDBY:** Press this button to turn the unit ON from STANDBY mode. Press it again to turn the set back to STANDBY.

REAR Connections



All the terminals are (from left to right):
 POWER SOCKET, VIDEO, AUDIO INPUT, YPbPr INPUT
 Note: AV and component (YPbPr) share the R and L audio inputs.

SIDE Connections



All the terminals are (from left to right):
 HDMI1, HDMI2, USB, VGA, PC AUDIO, HEADPHONE, COAXIAL, RF.
 Note: When HDMI has an input signal coming from a DVI source then the audio input signal must be connected to the PC audio input.

ANTENNA

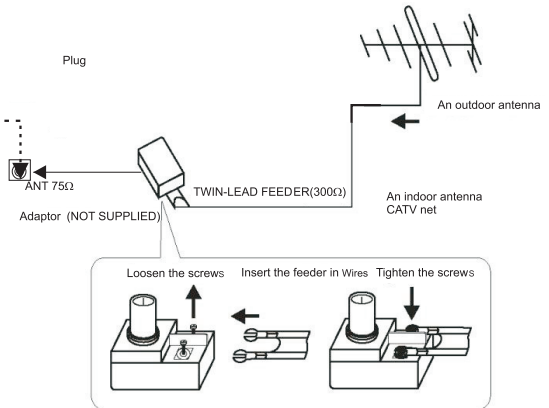
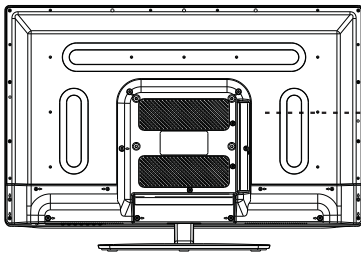

Note:
Aerial connections: IEC (female).
Input impedance: 75 Ω unbalanced.

PC

STEPS:

Be sure both the TV and computer are powered off.

1. Connect a VGA and audio cable.
2. Connect the power cord.
3. Turn on the TV, switch to PC mode.
4. Turn on the PC.

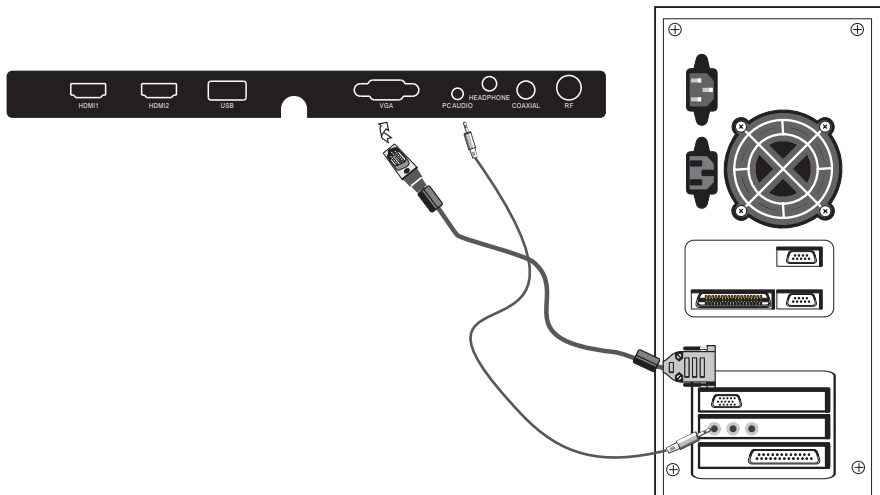

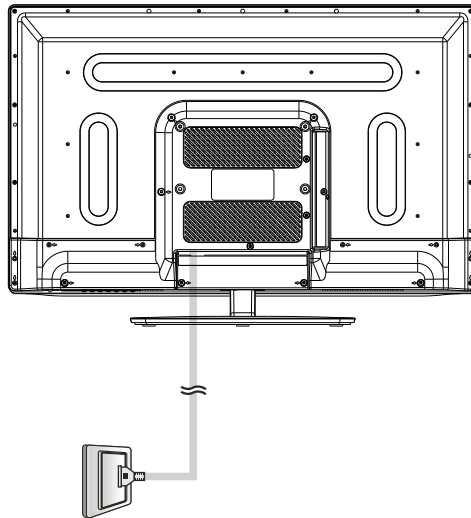

PC

PRESET MODE

	RESOLUTION	V.Freq.(Hz)	H.Freq.(KHz)
1	720*400	70	31.47
2	640*480	60	31.47
3	640*480	75	37.50
4	800*600	60	37.88
5	800*600	75	46.88
6	1024*768	60	48.36
7	1024*768	70	56.48
8	1024*768	75	60.02
9	1280*1024	60	63.98
10	1280*1024	75	80.00
11	1366*768	60	67.50
12	1920*1080	60	67.50

AV EQUIPMENT

There are two HDMI ports located on the back of your TV. You can connect a Blu-ray player, DVD player, or other video equipment through these ports. There is one composite (Y, Pb, Pr) and one composite (AV) video input located on the back of your TV. You can connect a VCR, cable box, or other video equipment to these jacks. Please see the diagram below. You may also need to refer to the owner's manual of the device that you are trying to connect.

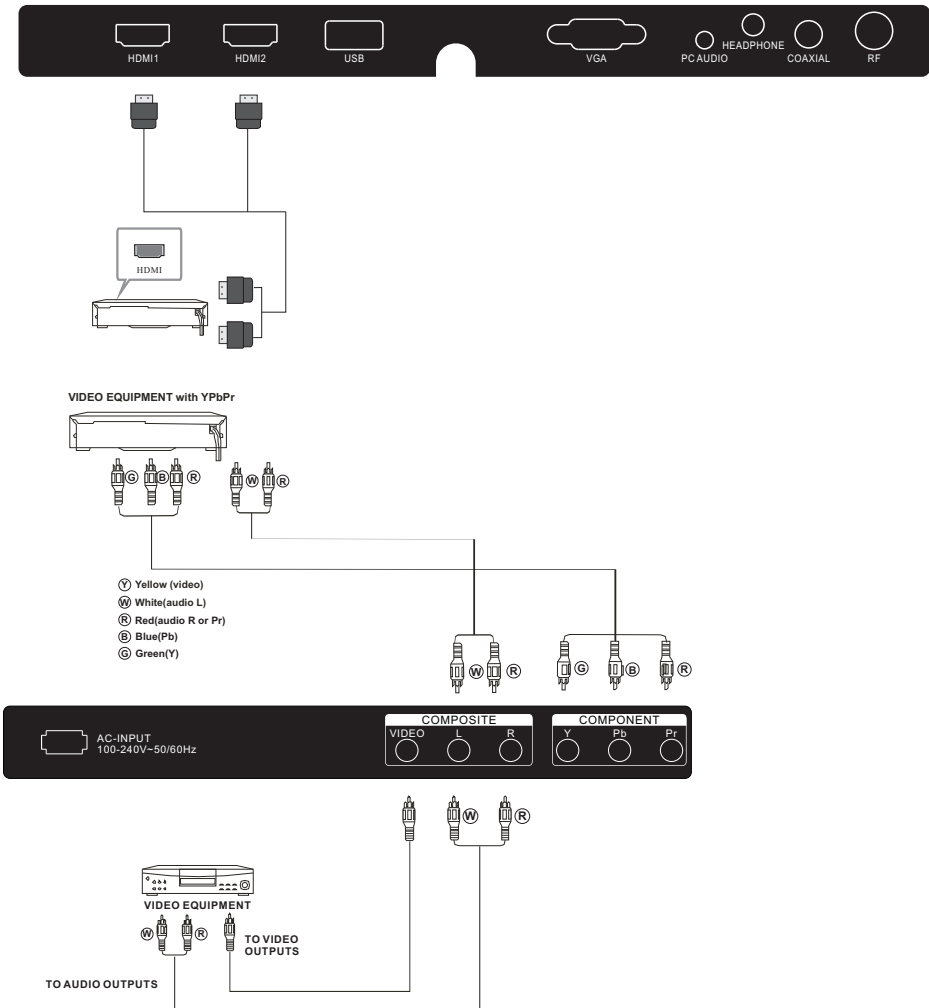

The television's inputs can be connected to the following types of equipment: VCR, multi disc player, DVD, camcorder, video game or stereo system, etc.....

YPbPr can support these video formats:480i,576i,480p,576p,720p,1080i.

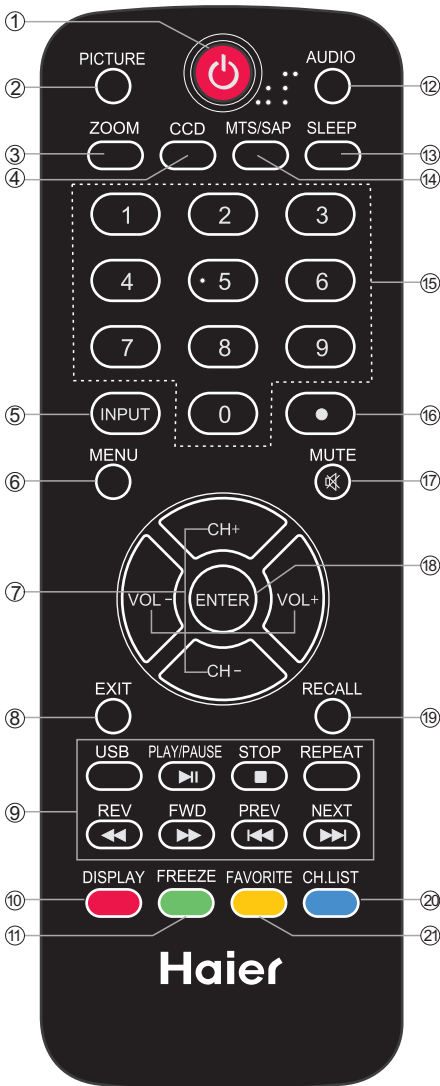

1. Press to turn on and off the TV.
2. Press repeatedly to cycle through the available picture modes.
3. Press to change the aspect ratio.
4. Select a closed caption option.
5. Show the input source menu.
6. Press to open the on-screen menu.
7. Press CHANNEL ^ or CHANNEL v to go to the next or previous channel in the channel list. Press VOLUME+ or VOLUME- to increase or decrease the volume.
8. Exit On Screen Display.
9. USB: Press to launch the USB multimedia mode ◀◀▶▶ Previous/Next ◀▶▶ No Function ■ Stop ▶▶ Play/Pause REPEAT.
10. Press to display the TV status information on the top of the TV screen.
11. Press to freeze the picture you are watching.
12. Press to cycle through the different sound settings.
13. Press to display the sleep timer option.
14. Select MONO, STEREO, SAP in NTSC (analog TV) system.
15. Press to input a channel.
16. Press to select the digital sub-channels. For example, to enter "54-3", press "54", "●", and then "3".
17. Switches the TV sound on or off.
18. Press to confirm selections in an on-screen menu or to open a submenu.
19. Press to go to the last viewed channel.
20. Open the channel list in TV mode.
21. Open the favorite channel list in TV mode.

1. PICTURE MENU

In this menu, you can adjust the picture options here, such as contrast, brightness, etc. Press ▼▲ to select, press ENTER to adjust.

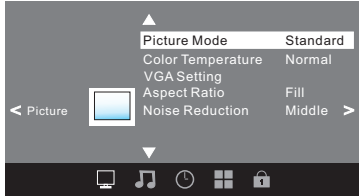

Note:

- 1) If you want to adjust contrast, brightness, color, and sharpness, the picture mode must be set to personal.
- 2) This will increase or decrease Warm (red) and Cool (blue) colors to suit your personal preference.

Select Cool to give the white colors a blue tint, Normal to give the white colors a neutral tint, Warm to give the white colors a red tint.

Standard mode is the default setting, if you select some other options, the power consumption may change.

1.1 Advanced

When a PC is connected, you can adjust the PC advanced settings.

- 1) H-Pos: Adjust the horizontal position of the screen.
- 2) V-Pos: Adjust the vertical position of the screen.
- 3) Clock: Fine tune the screen width.
- 4) Phase: Fine tune the phase of the screen. Usually you don't adjust this item.
- 5) Auto: Auto adjust to fit the screen.

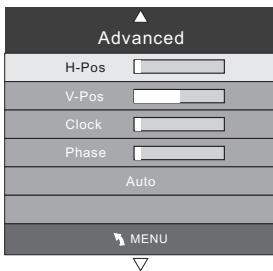

2. AUDIO menu

In this menu, you can adjust the sound options here. Press ▼▲ to select, press ENTER to adjust.

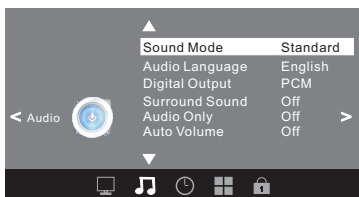

Note:

- 1) Audio language is available in ATSC/TVmode only.
- 2) Auto volume is available only when the input signal volume is too large or there is distortion.

3. TIMER MENU

In this menu, you can adjust the sleep timer, time zone, etc. Press ▼▲ to select, press ENTER to adjust.

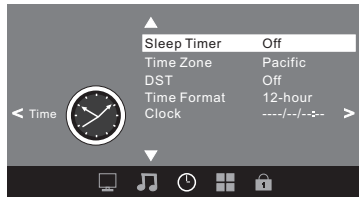

Note:

- 1) Time zone, DST (Daylight Saving Time) and the clock are available in ATSC mode only, and the Clock can't be adjusted.

4. OPTION menu

In this menu, you can adjust the Menu language, Closed Caption, Restore Default etc. Press ▼▲ to select, press ENTER to adjust.

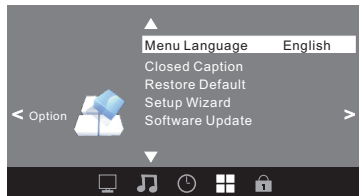

4.1 Closed Caption

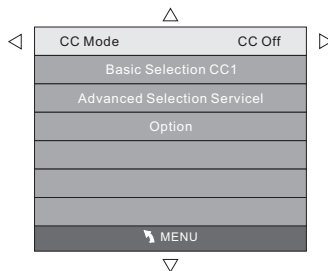

- 1) CC Mode: Switch the closed caption mode.
- 2) Advanced selection: only available in ATSC.
- 3) Option: Used to edit the CC font.

Note:

- 1) Restore Default: Restore Default will clear all the programs and reset all the settings to default value.

5. LOCK MENU

In this menu, you can change the password and adjust the vchip settings.

Enter the password, to enter the lock menu. The factory default password is 0000.

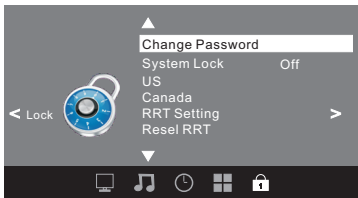

5.1 Change Password

- 1) Old password: Input the old password.
- 2) New password: Input the new password.
- 3) Confirm password: Input the new password again.

5.2 System Lock

When the System Lock option is ON, the options listed below can be adjusted.

5.3 US

Press ENTER to display the following screen.



- 1) TV: Press ENTER to display the following screen.

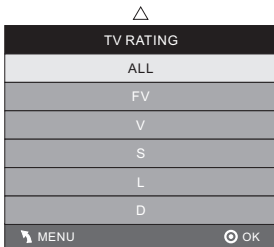

Rating	Content	Content				
		FV (Fantasy violence)	V (Violence)	S (Sexual situation)	L (Adult language)	D (Sexually suggestive dialog)
Suggested age	TV-Y (All children)					
	TV-Y7(Direct to order children)	X				
	TV-G(General audience)					
	TV-PG(Parental Guidance suggested)		X	X	X	X
	TV-14(Parents strongly cautioned)		X	X	X	X
	TV-MA(Mature audience only)		X	X	X	

And use the ENTER key to lock/unlock Parental Controls .

- 2) MPA: Switching the movie-rating control level; N/A, G, PG, PG-13, R, NC-17, X.

Rating	Description
G	General audiences, All Ages admitted
PG	Parental Guidance suggested. Some material may not be Suitable for children.
PG-13	Parents strongly cautioned. Some material .may be Inappropriate for children under 13.
R	Restrict. Under 17 requires accompanying parent or adult guardian(age varies in some jurisdictions)
NC-17	No one 17 and under admitted.
X	X is an older rating that is unified with NC-17 but may be encoded in the data of older movies.

5.4 Canada

Press ENTER, to display the following screen.



- 1) Canada English: Switching the English rating control level: EXEMPT, C, C8+, G, PG, 14+, 18+.

Rating	Description
E	Exempt: Includes news, sports, documents and other information programming: talk shows, music videos, and variety programming.
C	Children: Intended for younger children under the age of 8 years. Pays careful attention to themes that could threaten their sense of security and well-being.
C8+	Children over 8 years old: Contains no portrayal of violence as the preferred, acceptable, or only way to resolve conflict; nor encourage children to imitate dangerous acts which they may see on the screen.
G	General: Considered acceptable for all age groups. Appropriate viewing for the entire family, contains very little violence, physical, verbal or emotional.
PG	Parental Guidance: Intended for a general audience, but may not be suitable for younger children (under the age of 8) because it could contain controversial themes or issues.
14+	Over 14 Years: Could contain themes where violence is one of the dominant elements of the storyline. But it must be integral to the development of plot or character. Language usage could be profane and nudity, present within the context of theme.
18+	Adults: Intended for viewers 18 years and older and might contain depictions of violence, which while related to the development of plot, character or themes, are intended for adult viewing. Could contain graphic language and portrayals of secretary and nudity.

2) Canada French: Switching the French-rating control level: E, G, 8ANS+, 13 ANS+, 16ANS+, 18ANS+.

Rating	Description
E	Exempt programming
G	General :All ages and children, contains minimal direct violence, but may be integrated into the plot in a humorous or unrealistic manner .
8ans+	General but inadvisable for young children :May be viewed by a wide public audience, but could contain scenes disturbing to children under 8 who cannot distinguish between imaginary and real situations. Recommended for viewing with paren.
13ans+	Over 13 years: Could contain scenes of frequent violent scenes and in tense violence.
16ans+	Over 16 years: Could contain frequent violent scenes and violence.
18ans+	Over 18 years: Only for adult viewing. Could contain frequent violent scenes and extreme violence.

5.5 RRT setting

in ATSC digital TV mode, it can be adjusted

5.6 Reset RRT:

Press ENTER, the screen will be displayed as follow:

6. Channel MENU

In this menu, you can adjust digital and analog TV Channels.

Press ▼▲to select, press ENTER to adjust.

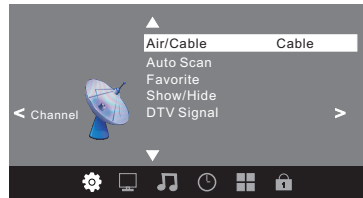

6.1 Air/Cable:

Select Air TV signal and cable TV signal.

6.2 Auto Scan:

If it's the first time you use the TV, you should scan all the TV channels first.

Press ENTER to confirm, to display the following screen.

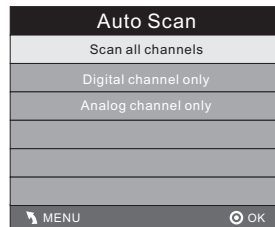

Press ENTER to select a scan type, you will see the message below which indicates that the auto search is in progress.

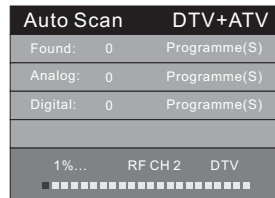

6.3 Favorite:

















Press ENTER to choose/delete favorite channels.

6.4 Show/Hide

Press ENTER to display/ hide the current channel.

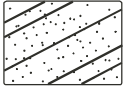
6.5 DTV signal

Display DTV strength signal. It can't be selected or adjusted.

Trouble phenomenon Symptom		Inspection/ Check
Picture	Audio	
 Snow	 Noise	antenna position, direction or connection
 Ghost	 Normal audio	antenna position, direction or connection
 Interference	 Noise	microwave, electronic equipment, car/motorcycle, fluorescent light
 Normal Picture	 Mute	Volume (check if mute is activated or if the audio system connections are not correct)
 No picture	 Mute	Power cord is not inserted Contrast and brightness/volume setup Press standby key on the remote control
 No color	 Normal audio	Color control Component (Y Pb Pr) connections
 Picture breaking up	 Normal audio or weak	Retune channel
 No color	 Noise	TV system

The LCD TV panel is built with very high precision technology giving you fine picture details in vibrant color. Occasionally, a few non-active pixels may appear on the screen as a fixed point of red, green, blue, black or white. Please note this does not affect the performance of the product.

Warranty

This Haier brand product, when shipped in its original container, will be free from defective workmanship and materials, and agrees that it will, at its option, either repair the defect or replace the defective product with a new or re-manufactured equivalent, for parts or labor for the periods set forth below:

This warranty does not apply to the appearance of the product or the exterior of the product, which has been damaged or defaced, altered or modified in design or construction. It does not apply to the additional excluded items set forth below:

The warranty commences on the date the item was purchased and the original purchase receipt must be presented to the authorized service center before warranty repairs are rendered.

The limited warranty described herein is in addition to whatever implied warranties may be granted to purchasers by law. ALL IMPLIED WARRANTIES INCLUDING THE WARRANTIES OF MERCHANTABILITY AND FITNESS FOR USE ARE LIMITED TO THE PERIOD(S) FROM THE DATE OF PURCHASE SET FORTH BELOW. Some states do not allow limitations on how long an implied warranty lasts, so the above limitation may not apply to you.

Neither the sales personnel of the seller nor any other person is authorized to make any warranties other than those described herein, or to extend the duration of any warranties beyond the time period described herein on behalf of Haier.

The warranties described herein shall be the sole and exclusive warranties granted by Haier and shall be the sole and exclusive remedy available to the purchaser. Correction of defects in the manner and for the period of time described herein, shall constitute complete fulfillment of all abilities and

Responsibility of Haier to the purchaser with respect to the product, and shall constitute full satisfaction of all claims, whether based on contract, negligence, strict liability or otherwise. In no event shall Haier be liable, or in any way responsible for any damages or defects in the product which were caused by repairs or attempted repairs performed by anyone other than an authorized service center or dealer; nor shall Haier be liable, or in any way responsible for incidental or consequential economic or property damage. Some states do not allow the exclusion of incidental or consequential damages, so that above exclusion may not apply to you.

THIS WARRANTY GIVES YOU SPECIFIC LEGAL RIGHTS. YOU MAY ALSO HAVE OTHER RIGHTS WHICH VARY FROM STATE TO STATE.

Warranty period for this product is one year parts and labor. Additional items excluded from warranty coverage:non-rechargeable batteries.What to do to obtain service or to obtain product literature,accessories,supplies or customer assistance:Simply call 1-877-337-3639. Be sure to have proof of purchase.

Free Manuals Download Website

<http://myh66.com>

<http://usermanuals.us>

<http://www.somanuals.com>

<http://www.4manuals.cc>

<http://www.manual-lib.com>

<http://www.404manual.com>

<http://www.luxmanual.com>

<http://aubethermostatmanual.com>

Golf course search by state

<http://golfingnear.com>

Email search by domain

<http://emailbydomain.com>

Auto manuals search

<http://auto.somanuals.com>

TV manuals search

<http://tv.somanuals.com>