

Haier

LED LCD TV RECEIVER

USER MANUAL

Please read this manual carefully before using your television and keep this manual in a good place for future reference.

MODEL:
LET26C430
LET32C430

Contents

01	Safety and warnings	
	Welcome	P.02
	Important information	P.02
	Safety notice	P.03
	Warnings and cautions	P.04
02	Introduction	
	Main Parameter	P.05
	Base Stand Assembly Instruction.....	P.07
	Wall mounting installation guidelines	P.08
	Front panel	P.09
	Rear AV connections	P.09
	Connecting your TV.....	P.10
	Common interface	P.11
03	Remote Control	
	Remote Control	P.12
04	Operation	
	Installation Guide	P.14
05	Trouble shooting	
	Trouble shooting	P.22
	Specification	P.23

01 Safety and Warnings

WELCOME

Thanks for buying this 26"/ 32" LED LCD TV. This guide will help you set up and begin using your TV.

First, check the contents of your box with the parts check list below:

26" Full HD 1080P Digital LED LCD TV	32" HD Ready LED LCD TV
Remote control	Remote control
AAA battery x2	AAA battery x2
Instruction Manual	Instruction Manual
Quick start guide	Quick start guide
Scart cable x1	Scart cable x1
Adaptor	Adaptor

Now you can get started!

IMPORTANT INFORMATION

READ ALL INSTRUCTIONS BEFORE USE AND KEEP FOR FUTURE REFERENCE.



CAUTION
RISK OF ELECTRIC SHOCK
DO NOT OPEN



CAUTION

TO REDUCE THE RISK OF ELECTRIC SHOCK, DO NOT REMOVE COVER (OR BACK). NO USER SERVICEABLE PARTS INSIDE. FOR ANY PROBLEMS, REFER SERVICING TO THE CUSTOMER HELP LINE. THERE IS A LIGHTNING ARROW SYMBOL IN THE TRIANGLE: THIS SYMBOL INDICATES HIGH VOLTAGE IS PRESENT INSIDE. IT IS DANGEROUS TO MAKE ANY KIND OF CONTACT WITH ANY INSIDE PART OF THIS PRODUCT.

THERE IS AN EXCLAMATION MARK IN THE TRIANGLE: THIS SYMBOL ALERTS YOU THAT IMPORTANT LITERATURE CONCERNING OPERATION AND MAINTENANCE HAS BEEN INCLUDED WITH THIS PRODUCT.



CAUTION: TO REDUCE THE RISK OF ELECTRIC SHOCK AND FIRE, DO NOT PUT THE TV SET NEAR SOURCES OF HUMIDITY. DO NOT USE ANY ABRASIVE CLEANERS WHICH MAY SCRATCH OR DAMAGE THE LCD SCREEN. AVOID CONTACT WITH OBJECTS THAT MAY SCRATCH THE LCD SCREEN.



NOTE: SERVICING THE UNIT YOURSELF IS UNAUTHORISED AND COULD LEAD TO INJURY OR PRODUCT DAMAGE. REFER ALL SERVICING TO THE CUSTOMER HELPLINE.

SAFETY NOTICE

- " For your protection, please read these instructions completely and keep this manual for future reference.
- " Please ensure that the set has adequate ventilation.
- " Do not place the set near a heat source or in direct sunlight.
- " Do not put the unit near water or oil as it may cause a fire.
- " During thunderstorms, unplug both the antenna and power plug to prevent damage.
- " Do not use a damaged power plug or put the power supply near a heat source as it may cause electric shock or fire.
- " To prevent potential fire, do not overload an electrical outlet with too many plugs.
- " Place the set on a level surface to prevent it from tipping and potential damage.
- " Do not remove the cover of the set or try to service your TV. This may result in electrical shock or fire. All service work must be completed by an authorised technician.
- " If there are any abnormal sounds or smells from the unit, unplug it immediately and contact an authorised service provider.
- " To prevent fire, do not use or store any flammable materials near the unit.
- " To prevent fire, do not place the unit near a damp wall.
- " To prevent electric shock, ensure that any external antenna connected to the set is clear of contact with any power lines.
- " Do not plug/unplug the unit while your hands are wet. This may cause an electric shock.
- " Please ensure a solid connection with the AC wall socket in order to avoid shock and potential fire.
- " To prevent electric shock or fire, please prevent rain from entering the set along the wire connected to the outside antenna.
- " When cleaning, please unplug the unit. Use a soft cotton cloth. Do not use any abrasive cleansers, and prevent water from entering the set.
- " If any plugs or input wires are dirty, unplug the set and clean them. This will prevent the risk of electric shock or fire.
- " If the set is not going to be used for an extended period, unplug the unit from the main power.

The apparatus should not be exposed to dripping or splashing and no objects filled with liquids, such as vases should be placed on the apparatus.

The mains plug is used for disconnecting the device, make it easily accessible.

Do not use any accessories that are not recommended by the manufacturer.

WARNINGS AND CAUTIONS

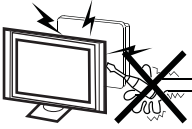

Warning ⚡

High voltages are used in the operation of this television receiver. Do not remove the cabinet back from your set. Refer servicing to qualified service personnel.

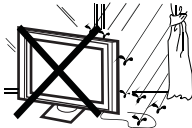

Warning ⚡

To prevent fire or electrical shock hazard, do not expose the television receiver to rain or moisture.



Warning ⚡

Do not drop or push objects into the television cabinet slots or openings. Never spill any kind of liquid on the television receiver.



Caution ⚠

Do not block the ventilation holes in the back cover. Adequate ventilation is essential to prevent failure of electrical components.

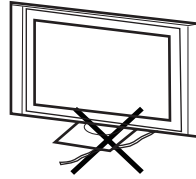

Caution ⚠

Do not trap the power supply cord under the television receiver.

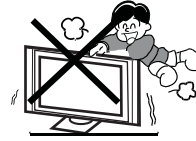

Caution ⚠

Never stand on, lean on, or suddenly push the television or its stand. You should pay special attention to children. Serious injury may result if it should fall.



Caution ⚠

Do not place your television on an unstable cart, stand, shelf or table. Serious injury to an individual, and damage to the television, may result if it should fall.



Caution ⚠

When the television receiver is not used for an extended period of time, it is advisable to disconnect the AC power cord from the AC outlet.

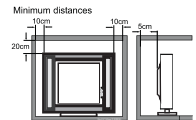

Caution ⚠

If the television is to be built into a compartment or similar enclosure, the minimum distances must be maintained. Heat build-up can reduce the service life of your television, and can also be dangerous.

02 Introduction

CAUTION

Never tamper with any components inside the TV, or any other adjustment controls not mentioned in this manual. All LED-TVs are high voltage instruments. When you clean up dust or water drops on the LED PANEL or CABINET, the power cord should be pulled out from the receptacle, then wipe the TV with a dry soft cloth. During thunder and lightning, unplug the power cord and antenna cord to prevent damage to your TV. All repairs to this TV should only be performed by qualified TV service personnel.

INSTALLATION

- *Locate the TV in the room where light does not strike the screen directly.
- *Total darkness or a reflection on the picture screen can cause eyestrain. Soft and indirect lighting is recommended for comfortable viewing.
- *Allow enough space between the TV and the wall to permit ventilation.
- *Avoid excessively warm locations to prevent possible damage to the cabinet or premature component failure.
- *Do not cover the ventilation openings when using the TV.

Main features

- ① Used as Television, display terminal, PC display;
- ② High luminance, wide viewing Angle;
- ③ HDMI interface and SCART Interface;
- ④ NICAM;
- ⑤ Time shift

Main parameter

Panel	26"	32"
TV System	PAL-B/G、I、D/K SECAM-B/G、D/K、L、L'	
Video Signal System	PAL/NTSC/SECAM	
Input Power Voltage	100-240V~ 50/60Hz	
Power consumption	55 W	75 W
Audio Output Power (THD≤7%)	2x5W	2x8W
Signal Input	Analog RGB(PC)x1 PC Audiox1 High-Definition Multimedia Interface (HDMI)x2 Video Input x1 CVBS Input x1 YPb Prx1 Mini Scart x 1 USB x 1 CI x 1 Tuner x 1	
Horizontal definition (TV line)	Composite Video input ≥350 YPbPr ≥400	

PC

PRESET MODE

	RESOLUTION	V.Freq.(Hz)	H.Freq.(KHz)
1	800*600	60	37.88
2	640*480	60	31.47
3	1024*768	60	48.36
4	1360x768	60	47.7
5	1280x1024	60	63.98
6	1920x1080 (Only for 26")	60	66.64

STAND INSTALLATION GUIDE

This STAND INSTALLATION GUIDE is provided to help you easily install the stand. Please carefully follow step 1 through Step 2.

1 Open the box and find the parts

Open the box and find the following parts.

- Stand x1 pc
- Screws x 4 pcs

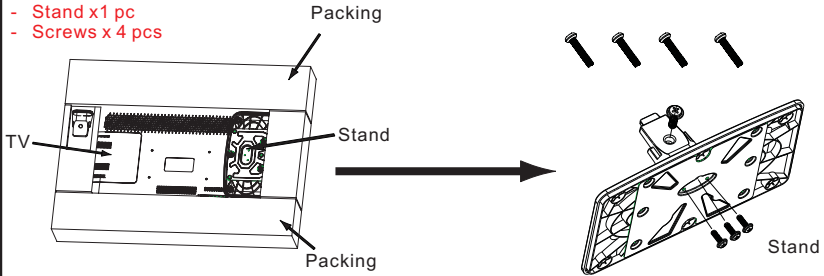

2 Place the stand on the TV

1. Insert the stand support pillar into the stand as the arrow indicated direction, and then fastened with three screws.

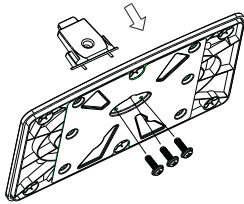

2. Insert the stand Ass'y into back cover as the arrow indicated direction, and then fastened with one screw.

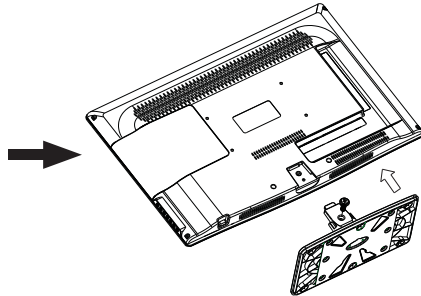

WALL MOUNTING INSTALLATION GUIDELINES

Wall Mounting Holes Spacing and Location

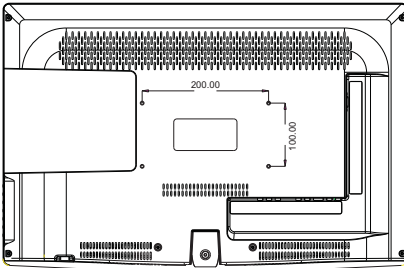

4 Wall mount M4 Screws

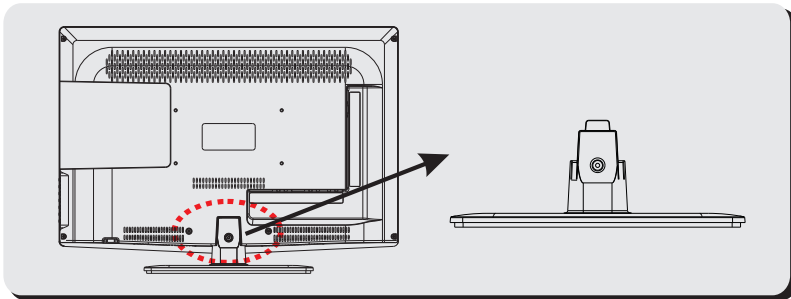

1. Use the screwdriver to remove 1 screws from the screw location.

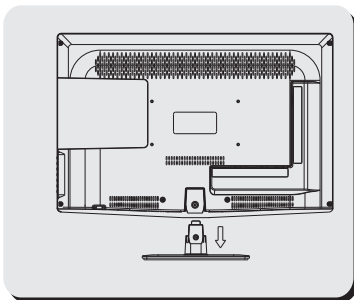

2. Remove the base stand from the Main body.

Front control panel

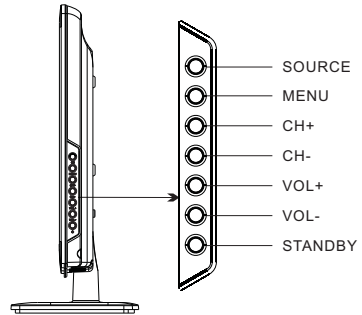
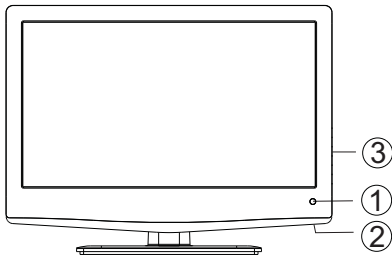

- | | |
|---|---|
| 1 | Remote control sensor. |
| 2 | Indicator LED:
Blue:POWER ON. RED STANDBY. |
| 3 | Key board. |

- | | | |
|---|------------------|--|
| 1 | SOURCE | Display the input source menu. |
| 2 | MENU | Display main MENU. |
| 3 | CH+/CH- | In TV mode,press CH+ or CH- to change the channel up and down.
In MENU, press CH+ or CH- to select items .
In standby mode, it can Turn on the TV. |
| 4 | VOL+/VOL- | Adjust sound level.
In MENU,adjust the item that you Selected. |
| 5 | STANDBY | |

Rear/Side Sockets

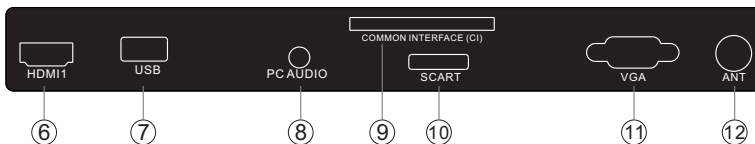
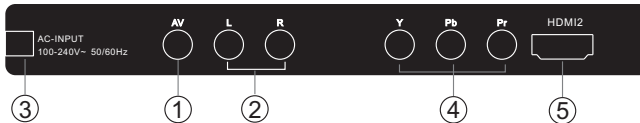

- | | | |
|---|------------------------|-------|
| 1 | AV | input |
| 2 | L/R AUDIO | input |
| 3 | AC Power Source | input |
| 4 | YPbPr | input |
| 5 | HDMI2 | input |
| 6 | HDMI1 | input |

- | | | |
|----|-----------------------------|-------|
| 7 | USB | input |
| 8 | PC AUDIO | input |
| 9 | COMMON INTERFACE(CI) | Input |
| 10 | SCART | Input |
| 11 | VGA INPUT | Input |
| 12 | ANT | input |

CONNECTING YOUR

TV

ANTENNA CONNECTION

Connect your aerial to the back of the TV into the ANT IN socket.

IMPROVE YOUR SIGNAL

To improve picture quality in a poor signal area, use a signal amplifier (not supplied).

CONNECT YOUR PC TO THE TV

You can use your TV as a monitor for your personal computer by connecting it with a VGA cable (not supplied).

- 1 Read your computer user guide and check it has a VGA connector.
- 2 Turn the power off on your TV and PC.
- 3 Connect a D type 15-pin VGA interface cable to the VGA video interface connector on the PC. Connect the other end of the cable to the PC interface connector on the TV. Tighten the screws on the VGA connectors and connect the audio cable (not supplied) to the audio input socket on the back of the TV.
- 4 Turn on the power of the TV firstly and then the PC.
- 5 Press the button on the TV or TV remote control to set the video input mode to VGA.
- 6 Once the image shows, if there is noise present, change the VGA mode to another resolution, change the refresh rate to another rate or adjust the brightness and contrast on the menu until the picture is clear.

CONNECT A DVD PLAYER OR VCR TO YOUR TV

There are two ways in which you can connect a DVD player or VCR to your TV. Make sure that both the TV and DVD player or VCR are switched off before you connect them.

- 1 Connect the AV DVD/VCR outputs to the AV IN socket on your TV.
- 2 Connect the AV audio L & R to the audio input (8). Press the **SOURCE** button on the TV to set the video input mode to AV.

SCART INPUT

- 1 Connect the scart lead from the external device (DVD player, Set-top box or games console) to the TV scart socket.
- 2 Press the **SOURCE** button to select SCART mode.
- 3 Press the **PLAY** button on the external device.

HDMI INPUT

- 1 Connect the cable from the HDMI device to the TV HDMI socket.
- 2 Press the **SOURCE** button to select HDMI mode.
- 3 Refer to the HDMI device user guide for how to operate.

COMMON INTERFACE

The common interface (CI) slot is designed to accept the conditional Access (CA) Module and Smart card in order to view the pay TV programmes and additional services. Contact your Common Interface service provider to get more information about the modules and subscription. Please noted that CA modules and smart cards are neither supplied nor optional accessories from us.

Warning

- Switch off your TV before any module is inserted in the Common Interface slot.

- 1** Insert the CAM correctly, then Smart Card to the CI slot that is located at the side of the TV.

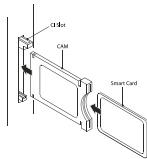

- 2** Turn on the TV and it will display the below message if the CA module is detected. Wait for few moments until the card is activated.

CI Module Inserted

- 3** Press the **MENU** button then press **▲ ▼** button to select CI Information option.

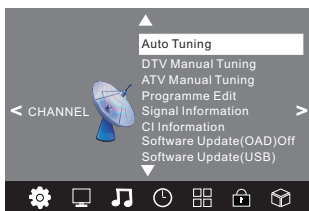

- 4** Detailed information on the CI card in use is displayed.
- 5** Press **OK** button to access the card menu. Refer to the module instruction manual for setting details.
- 6** When module is removed, the following message will appear on the screen.

CI Module Removed

03 Remote control

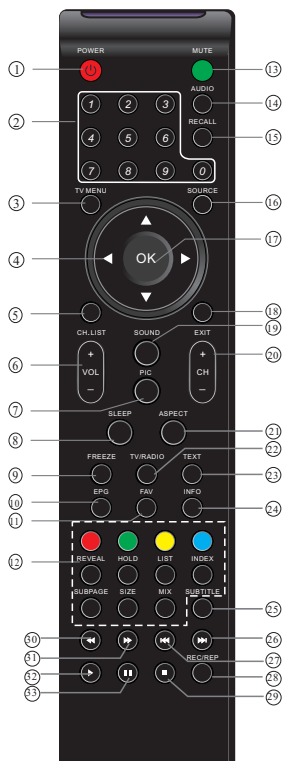

Insert Batteries Into the Remote Control

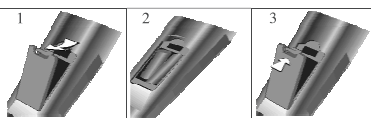

1. Remove the battery cover.
2. Inserting the 2 AAA 1.5V batteries making sure the polarity (+ or -) of the batteries matches the polarity marks inside the unit.
3. Mount the battery cover. Replace with new batteries when the TV set begins to show the following symptoms: Operation is unsteady or erratic. Sometimes the TV set does not function with Remote Control Unit.

Remark:

- 1) Alkaline Battery Recommended.
- 2) Remove batteries when they are exhausted or if the remote control is not to be used for Long time.

- 1: **POWER**: To set the TV to standby or power on.
- 2: **NUMERIC KEY**: For direct access to channels.
- 3: **TV MENU**: To display TV menu.
- 4: **CURSOR**: To move within the menu.
- 5: **CH. LIST**: To display the channels list.
- 6: **VOL +/-**: To adjust sound level.
- 7: **PIC**: To switch picture mode.
- 8: **SLEEP**: Set timer to turn off the TV.
- 9: **FREEZE**: To freeze the picture.
- 10: **EPG**: To display information about the program being viewed and what's on next in DTV mode.
- 11: **FAV**: To access your favourite channels list in TV or DTV mode.
- 12: **TELETEXT KEYS**: Please refer to next page.
- 13: **MUTE**: To disable or enable the sound output.
- 14: **AUDIO**: To select the available audio /language of TV programs .
- 15: **RECALL**: To access the previously viewed channel.
- 16: **SOURCE**: To select input source.
- 17: **OK**: To confirm selection.
- 18: **EXIT**: To return to the previous menu or exit menu.
- 19: **SOUND**: To switch sound mode.
- 20: **CH+/CH-**: To access the next or previous channels.
- 21: **ASPECT**: To change picture aspect ratio.
- 22: **TV/RADIO**: In DVB mode, it is used to switch between digital TV channels and radio stations. Display/remove the programme information.
- 23: **TEXT**: To enter or exit TELETEXT.
- 24: **INFO**: To display information about the channel being viewed or further information about the program when in small EPG screen in DTV mode.
- 25: **SUBTITLE**: To switch between different subtitles in DTV mode.

26. To skip to the next file in USB mode.
27. To skip to the previous file in USB mode.
28. **REC/REP**: Press to record the TV program you are watching in DTV Mode or press to repeat play in USB Mode.
29. Stop the media player in USB mode.
30. To scan in reverse, during USB, USB playback.
31. To scan in forward, during USB, USB playback.
32. Play the media player in USB mode.
33. Pause the media player in USB mode, time shift in DTV mode.



NOTE:

With no operation for 4 hours, the unit will swift into the standby mode automatically.

REMOTE CONTROL

TELETEXT

Teletext is an information system broadcast by certain channels which can be consulted like a newspaper. It also offers access to subtitles for viewers with hearing problems or who are not familiar with the transmission language (cable networks, satellite channels, etc.)

Press:	You will obtain:
TEXT	This is used to call or exit teletext modes. The summary appears with a list of items that can be accessed. Each item has a corresponding 3 digit page number. If the channel selected does not broadcast teletext, the indication 100 will be displayed and the screen will remain blank (in this case, exit teletext and select another channel).
SELECTING A PAGE 	Enter the number of the page required using the 0 to 9 up/down. Example: page 120, enter 120. The number is displayed top left, the counter turns and then the page is displayed. Repeat this operation to view another page. If the counter continues to search, this means that the page is not transmitted. Select another number.
DIRECT ACCESS TO THE ITEMS 	Coloured are as are displayed at the bottom of the screen. The 4 coloured keys are used to access the items or corresponding pages. The coloured areas flash when the item or the page is not yet available.
INDEX	This returns to the contents page (usually page 100).
SUB PAGE	Certain pages contain sub-pages which are automatically displayed successively. This key is used to stop or resume sub-page acquisition. The indication appears top left.
HOLD	To freeze the page.
REVEAL	To display or hide the concealed information (games solutions).
LIST	The user can set four favorite pages to be directly linked to the four color keys. While list mode is activated, it is not possible to use TOP or FLOF navigation with the colorkeys. The favorite page numbers should be stored and restored to/from nonvolatile memory for each channel by the system software.

04 OPERATION

Installation Guide

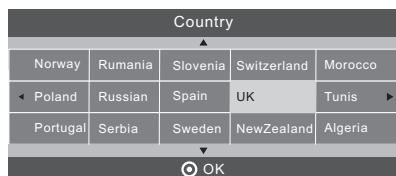
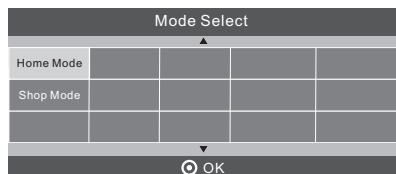
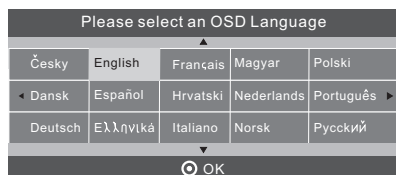

This screen only appear when the TV first time turn on or reset to factory set. You can choose language, energy-saving mode and country, auto tuning programs. And after tuning the screen will skip to the first DTV program.

1. CHANNEL MENU

The first item of the MENU is channel menu (for TV or DTV source only).

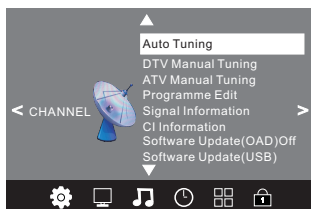

You can search channels and edit programs here.

1).Auto tuning:

Search all the channels automatically (you can select ATV and DTV)

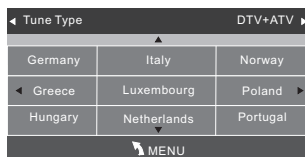

Pls press ◀▶▶▲ to select country at first, then press OK button to start auto tuning.

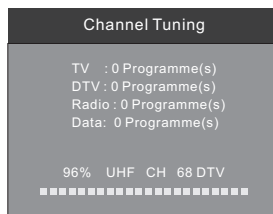

NOTE:

All the channels including ATV, DTV and Radio can be tuning by one time, if the Tune Type is DTV+ATV.

All the stored channels will be disappear after auto tuning.

After auto tuning, the channel will skip to the first DTV channel.

2).DTV Manual tuning:

You can select a DTV channel then find the program in this channel.

Pls press ◀▶ to select the channel, then press OK to search the programs.

NOTE:

Bad Normal Good means signal intensity.

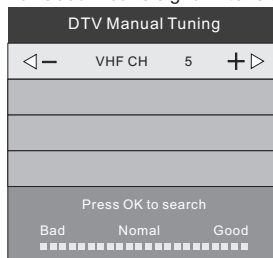

3). ATV Manual tuning :

You can change the sound system to search the analog TV channels and fine tune the channels, then storage the channels you selected.



NOTE:

Press teletext red button to storage to channels after manual tuning .

4). Program edit:

You can Delete ,Rename ,Move, Skip , FAV any programs.

● Delete

Press teletext red button , the program in cursor will delete.

● Rename:

Only can rename ATV programs .

Move the cursor to the program, press teletext green button to rename the program.

Press ▼▲ to choose the character. Press ◀▶ to move the cursor .

Press MENU button to exit edit , Press EXIT to exit the menu.

Note: ATV programs name only can be 5 character, DTV programs name can be 25 character.

● Move

Use the Arrow Buttons to select the channel you wish to move. Then press the Yellow Button to select Move function. Once active, enter the number button and then press OK to confirm.

● Skip

Press ▼▲ to choose the program , press teletext blue button to skip this program, The Ⓞ will show on the right side of the program .

Choose the skipped program, press blue button again , you can cancel the skip ,The Ⓞ will disappear .

● Favourite

Press ▼▲ to choose the program , press FAV button , it will show ♥ on the right side of the program.Choose the FAV program , press FAV button again , you can cancel the FAV,♥ the will disappear .

Once your favorite group is created, you can press the FAV key to quickly access your favorite channel.

5). CI information: (optional)

This menu can display the CI card' s information.

2. PICTURE MENU

The second item of the MENU is PICTURE MENU.

You can adjust picture effect here, such as contrast, brightness, etc.

Press OK to move, press OK to adjust.

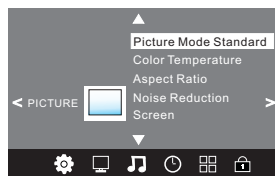

NOTE:

1).Tint is available in NTSC system only.

2).There are four colors temperature modes can be selected medium, warm, cool,user

3).Screen is available in PC mode only which can adjust Horizontal position, vertical position, size and phase.

3.SOUND MENU

The third item of the MENU is the SOUND MENU.

You can adjust the sound effect here such as treble, bass, balance etc.

Press ▼▲ to move, press OK to adjust.

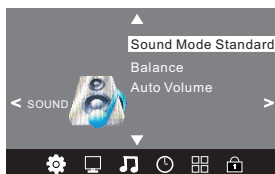

Note:

Auto volume: only available when the input signal volume is too large or distortion.

4.TIME MENU

The forth item of the menu is the TIME MENU

You can adjust the clock, power on/off time, sleep time etc Press ◀▶ to move, press OK to adjust

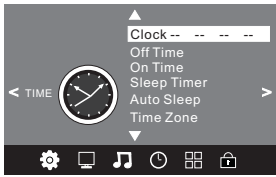

NOTE:

Within 15 minutes there is no signal, the TV will auto sleep , if Auto Sleep is set ON. The clock time can get from the DTV system auto.

5.OPTION MENU

The fifth item of the MENU is the OPTION MENU. You can adjust the Menu language, Audio language,Subtitle language etc.



In PVR File system menu you can set up USB disk for PVR.

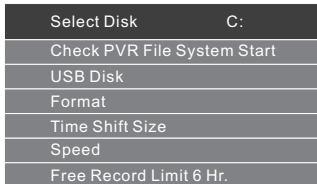

NOTE:

Restore factory default will clear all the programs and password.

6.LOCK MENU

The sixth item of the menu is the LOCK MENU You can lock system, set password, block program and set parental guidance Once you set the lock system on you can not search the channels or change any programs.



NOTE:

The default pass word is 0000, If you forget the password, you can use the super password:9443. Block program: Press ▼▲ to choose the program ,press teletext green button to block the program. If you want unblock the program, pls enter the main menu , input the password, then press green button again.Parental guidance: Press ◀▶ to choose rating.

7.EPG Menu(Electronic Program Guide).

The EPG menu is used to look at what is being broadcasted on DTV or Radio channel in the day. To access the EPG menu, press the EPG botton,the following menu will be displayed:

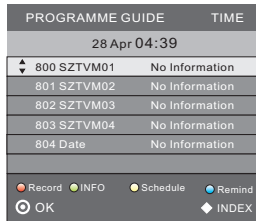

1. **INFO**

Use to choose the programs , Press INFO key, you can display the highlight program's information.

2. **Schedule**

Press the teletext yellow key, It can list all the reminder schedule, press ▼▲ to choose the list, press red key DELETE to delete the schedule list.

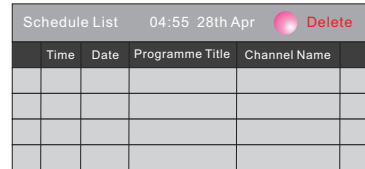

3. **Record**

Press the red key ,It can set the program to be recorded.

4. **Remind**

Press the blue key to choose one program and set up one reminder time, the TV screen will skip to the choosed program in the reminder time automatically.

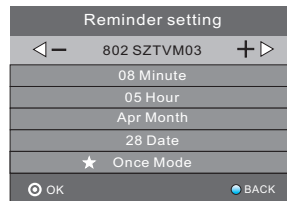

8.PVR function

1.Prepare to record the program

From OPTION MENU enter into PVR File System in “OPTION MENU” , please choose “check PVR File System” . Click “OK” , until “checking” change into “Success” .

Note: please check the term “speed” . If it is “HD support” , that means the speed of USB device is available for time shift and record. If not, please format the device, to make sure the device available. The default “Free Record Limit” is 6 hour, if the space on the disk is big enough. If the space is not big enough, the record time should be shorter, depends on the room on the device. During the “check PVR File System” checking, please do not take any other operation until it finished.

The recordings have to be done with TV PVR system. It can only be played in the same TV, not in other kind of devices (computer, DVD, etc...) which doesn't be compatible with .TS. Format.

See that in order to carry out any kind of recording, the TV will oblige you to format the connected device to store the recording.

WARNING. WHEN YOU FORMAT, THE EXTERNAL DEVICE WILL LOSE ALL THE FILES AND INFORMATION YOU STORAGE IN THE DEVICE.

From OPTION MENU enter into PVR File System as below:

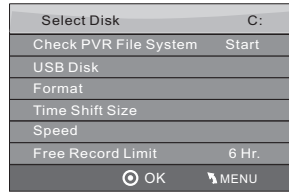
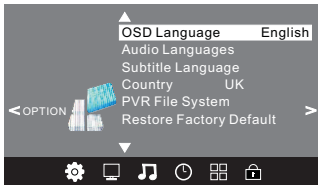

Select Disk:select which disc to save the record file.

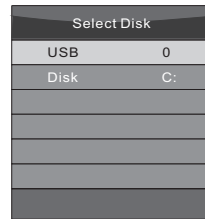

Check PVR File System: check if the PVR File System set up in the USB device or not.

Format:

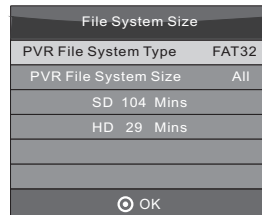
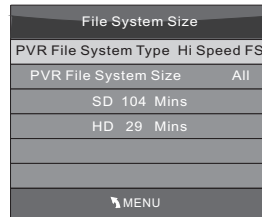

(Suggest to format the device by “High Speed Fs...”, which can speed up the record.)

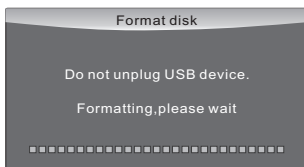
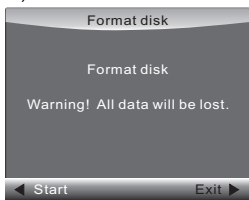

below menu appear after Format finish:

Select Disk	C:
Check PVR File System	Checking
USB Disk	Pass
Format	Pass
Time Shift Size	All
Speed	Checking
Free Record Limit	6 Hr.
MENU	

Select Disk	C:
Check PVR File System	SUCCESS
USB Disk	Pass
Format	Pass
Time Shift Size	All
Speed	HD support 2048 KB/s
Free Record Limit	6 Hr.
MENU	

If you select the “Hi Speed FS ” format mode, then you can change the time shift size:

Time Shift Size	
Time Shift Disk Size	512 MB
SB	14 Mins
HD	4 Mins

2.Record the program

As playing the DTV source, choose the channel and click “record”, the record frame will pop up. Click “record”, the record frame will disappear and the “REC” icon still on the left top. It will disappear until you click “stop”.

3.Play the record

In “USB”, the record program will be saved in the folder “_MSTPVR” on the device.

1. The USB storage size needs to be the size between 4GB to 500GB.
2. Video may become pixelated when Video bit rate is too low.
3. Not all USB devices are compatible. Below is a list of recommended USB drives. Models that are not listed may be compatible, but it is not guaranteed to work.

The USB support list are the same as Timeshift function ,see page 20.

9. Timeshift function

1. Prepare to record the program

This TV allows you to pause and record the currently watched digital program to a USB storage device, and to resume to the point where it was paused.

NOTE:

- Formatting a USB 2.0 storage device will be needed. Save your original data before formatting. All the data stored in the USB device will be erased after formatting.

USB Drive Storage Format

Select to format the USB device and allocate the amount of space for the Time Shift function.

NOTE:

- The format process will take at least 2 minutes. Please do not turn off the power or remove the USB device during formatting.
- During formatting, a speed test will be done on the USB device. If it fails, it means the USB device may not support the Time Shift function.

Record a paused DTV program to USB storage device

1. While in the DTV input source, insert USB storage device to the USB port on the side of your TV.
2. Press PAUSE (33) to start Time Shift function. The TV program paused. The Time Shift OSD appears, and starts recording.
3. Press STOP (29) to stop Time Shift function and stop recording program.



NOTE:

- Please do not unplug the USB storage device when the Time Shift function is activated.
- Approximately 4GB of memory buffers about offer 140 minutes.

Time Shift limitations:

1. When the Time Shift feature is activated, only the PLAY/PAUSE/STOP/FWD/REV/VOL+/VOL-/MUTE keys and some basic operation keys (ENTER/EXIT/navigation keys) are available.

2. Video playback may not be smooth and skip if USB recording speed does not meet the minimum requirements .

3. Do Not remove USB disk or switch off the power during Time Shift operations. It will abort once the signal is lost.

4. Do Not remove the signal source during Time Shift operations.

5. Do Not quickly and repeatedly change operations between PLAY/PAUSE/FWD/REV.

6. Video may become pixelated when Video bit rate is too low.

7. Not all USB devices are compatible, The USB hard disk drive electricity should be < 500MA.

Below is a list of recommended USB drives. Models that are not listed may be compatible, but it is not guaranteed to work.

- SanDisk Extreme® Contour™ USB Flash Drive - 8GB SDCZ8-8192-E75
- SanDisk Extreme® Contour™ USB Flash Drive - 16GB SDCZ8-016G-A75
- Kingston DataTraveler 410 USB 2.0 Flash Drive - 8GB DT410/8GB
- Kingston DataTraveler 410 USB 2.0 Flash Drive - 16GB DT410/16GB
- OCZ Technology Rally2 USB 2.0 Flash Drive - 4GB OCZUSB2DC-4GB
- OCZ Technology ATV USB 2.0 Flash Drive - 8GB OCZUSBATV-8GB
- OCZ Technology Rally2 USB 2.0 Flash Drive - 8GB OCZUSB2DC-8GB
- SAMSUNG-HM500JI-500G

8. This feature is not available for all digital TV, such as scrambled or audio only channels.

10.USB Player

Press source key, and select USB in source list, press OK button to enter the USB menu.

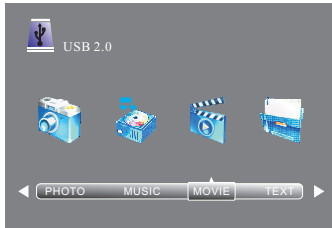

Please make sure that the USB device have plugged in the slot. There are four type media item can be selected, such as photo, music, Movie, and text. Select the type media item by pressing ◀ ▶ , press OK button to enter the disk selection menu.

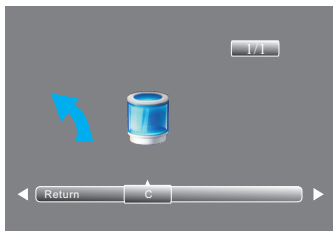

Press the ◀ ▶ to select the right disk and press OK to display media files and folder list or choose Return to back to the media type selection menu.

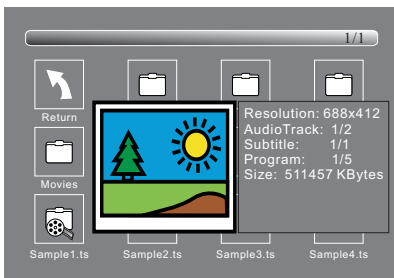

Select the media file by pressing ◀ ▶ or ▼ ▲ , then the preview frame will pop up. Press the button ▶ to play the media file in full screen. When the media file (photo, music, Movie, or text type) is playing, press the OK or Info button can display the control bar.



Press ◀ ▶ to select the function icon, press OK button to confirm the function.







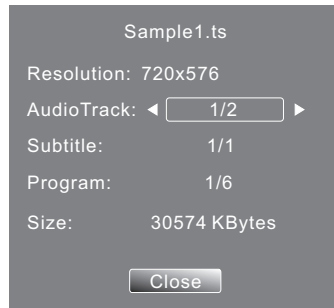









Press ▼ or EXIT button to exit the control bar.

NOTE:

You can adjust the audio track, or program in the Info menu while Playing the video file. Choose the Info icon and press OK can display the Info MENU.

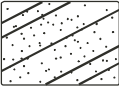

05 Trouble shooting

Trouble phenomenon Symptom		Inspection Check	
Picture	Audio		
 <p>Snow</p>	 <p>Noise</p>	antenna position, direction or connection	
 <p>Ghost</p>	 <p>Normal audio</p>	antenna position, direction or connection	
 <p>Interference</p>	 <p>Noise</p>	electronic equipment, car/ motorcycle, fluorescent light	
 <p>Normal Picture</p>	 <p>Mute</p>	Volume (check if mute is activated or if the audio system connections are not correct)	
 <p>No picture</p>	 <p>Mute</p>	Power cord is not inserted Power switch is not opened Contrast and brightness/volume setup Press standby key on the remote control for inspecting	
 <p>No colour</p>	 <p>Normal audio</p>	Colour control	
 <p>Picture breaking up</p>	 <p>Normal audio or weak</p>	retune channel	
 <p>No colour</p>	 <p>Noise</p>	TV system	

Specification

Colour system	PAL-B/G, I, D/K SECAM-B/G, D/K, L, L'	
Sound system	BG, DK, I, L, L'	
Video input	SCART, YP _b P _r , AV, VGA, HDMI, USB.	
Y/P_b/P_r	480i/p, 576i/p, 720p, 1080i, 1080p	
HDMI	480i/p, 576i/p, 720p, 1080i, 1080p	
Power requirements	AC 100-240V 50/60Hz	
Power consumption	55W(26")	75W(32")
Audio output	2x5W	2x8W
Environment conditions	Working temperature: +5°C - +35°C Working humidity: 20% - 80% Storage temperature: -15°C - +45°C Storage humidity: 5% - 90%	
Accessory	User manual Remote control Battery (x2) Quick start guide	

* The part specifications of this TV set provided here are for reference only.
Differences may occur as product technology is updated.
Design and specifications are subject to change without notice.

Scart Output description :

1. When current source is ATV/AV/SCART, scart output signal is ATV.
2. When current source is DTV, scart output signal is DTV.
3. Other source have no scart output signal.

Haier

Free Manuals Download Website

<http://myh66.com>

<http://usermanuals.us>

<http://www.somanuals.com>

<http://www.4manuals.cc>

<http://www.manual-lib.com>

<http://www.404manual.com>

<http://www.luxmanual.com>

<http://aubethermostatmanual.com>

Golf course search by state

<http://golfingnear.com>

Email search by domain

<http://emailbydomain.com>

Auto manuals search

<http://auto.somanuals.com>

TV manuals search

<http://tv.somanuals.com>