

---

# Haier®

## *TFT-LCD TELEVISION OWNER`S MANUAL*

*MODEL: L26M9/L32M9/L42M9/L46M9/  
L55M9/LB26R3/LB32R3/  
LB42R3/LB46R3/LP55R3*

Please READ this manual carefully before operating your TV, and retain it for future reference.

# CONTENT

Warning-----	1
Important Safety Instructions-----	2
Panel Control and Rear Terminals Control-----	4
Remote Control-----	5
Remote control function-----	6
External Equipment Connections-----	7
Antenna Connection-----	7
VCR Connection-----	8
DVD Setup-----	9
HDMI or DVI Setup-----	9
PC Setup-----	10
Monitor Out Setup-----	10
Connecting Headphones-----	11
Basic Receiving and Playing Operations	
Switching ON/OFF the TV set-----	12
Choose the Menu Language-----	12
Choose the Input Source-----	12
Searching Channel-----	13
Watching TV Program-----	15
Picture Control Functions-----	16
Sound Control Functions-----	17
Timer Functions-----	18
Function Menu-----	20
Adjust Menu-----	22
Lock Setup-----	23
Streaming Media Playing System-----	25
Maintenance-----	30
Troubleshooting-----	31
Specifications-----	32
Format-----	33

## Accessories

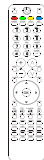

Remote controller





Owner's manual



Alkaline battery  
(AAA) × 2

## Warning

	<b>WARNING</b> RISK OF ELECTRIC SHOCK DO NOT OPEN	
<b>WARNING</b> TO REDUCE THE RISK OF ELECTRIC SHOCK DO NOT REMOVE COVER (OR BACK). NO USER SERVICEABLE PARTS INSIDE. REFER TO QUALIFIED SERVICE PERSONNEL.		
*To avoid electric hazards, it is strongly suggested that the back cover not be opened, as there is no any accessory inside the casing.		
*If necessary, please contact authorized after-sales services.		
*A lightning flash mark in a triangle: A potentially hazardous situation, which, if not avoided, could result in serious injury by high voltage.		
*An exclamation mark in a triangle: Major part or accessory of which technical specifications must be followed if it is to be replaced.		

### **Warning:**

To avoid fire or electric hazards, never place your television receiver in an area with heavy moisture. Attention should be paid to avoid accidental scratches or impacts onto the screen.

### **Caution:**

- ▲ Please read this manual carefully before using your television and keep this manual in a good place for future reference.
- ▲ To achieve the best performance of your television, read this User's Manual carefully and properly store it for future reference.
- ▲ Information of screen displays and figures in the User's Manual may vary due to technical innovations.

### **Caution:**

Unauthorized disassembly of this product is prohibited.

## Important Safety Instructions

The product should be tightly fixed to avoid drop damages and even fire.

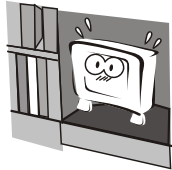

To avoid fire hazards, do not use this product under direct sunlight or closely to heat sources.

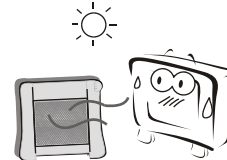

Do not locate the product close to water or oil, which may cause fire hazards.

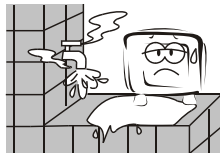

Unplug the power supply and antenna of the product when there is a rainstorm, especially Thunderstorm.



Do not use damaged or worn electric plugs, and keep electric cord away from heat sources to avoid electric shocks or fire hazards.



Do not connect excessive sockets in parallel or share the same socket by multiple plugs to avoid fire hazards.

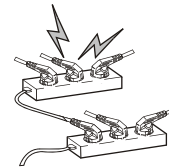

The product must be placed on a solid and stable surface to avoid collapse.

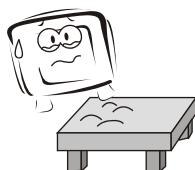

Unauthorized disassembly of the television is prohibited to avoid electric shocks or fire hazards. Contact authorized after-sales service if technical service is needed.

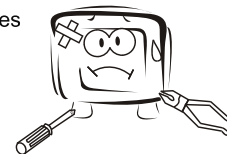

Keep the product away from a transformer or heat source to avoid fire hazards.

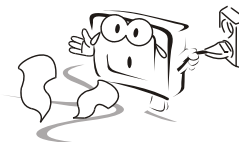
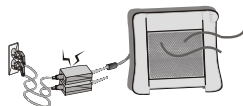

Disconnect the product from power supply and contact authorized after-sales service if abnormal sound is heard in the product.

## Important Safety Instructions

Don't use or store inflammable materials near the product to avoid explosion or fire hazards.

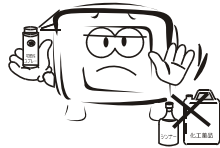

Don't place the product in a humid area to avoid fire hazards.

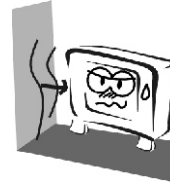

The antenna of the product should be away from electric cable to avoid electric shocks.

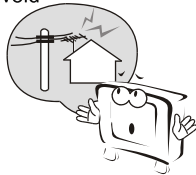

Never touch the plug when your hand is wet as this might cause electric shocks.

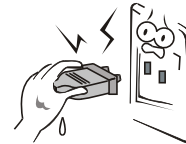

Always make sure that the television is well plugged as poor electric connection might cause fire.

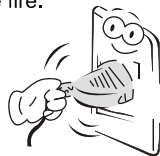

When antenna is used, measures should be taken to prevent water from flowing down along the cable into the television.



Unplug the television, use soft fabric, never chemicals, if you are going to make cleaning of the product. Make sure that no water drops in the product.

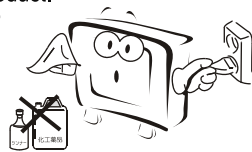

The plug and electric cable must be kept clean to avoid electric shocks or fire hazards.

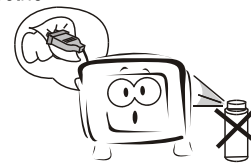

Disconnect the television from power supply and antenna when there is a rainstorm or thunderstorm to avoid electric shocks or fire hazards.



Disconnect the television from power supply to avoid electric shocks or fire hazards in a long vacation.

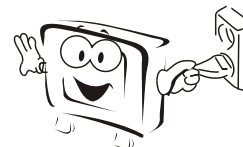

## Panel Control and Rear Terminals Control

- This is a simplified representation of front panel.
- Here shown may be somewhat different from your TV.

### Panel Control

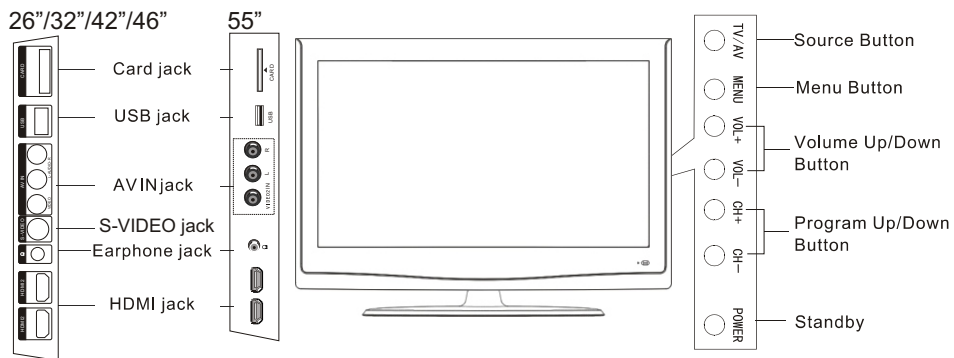

### Rear Terminals Control

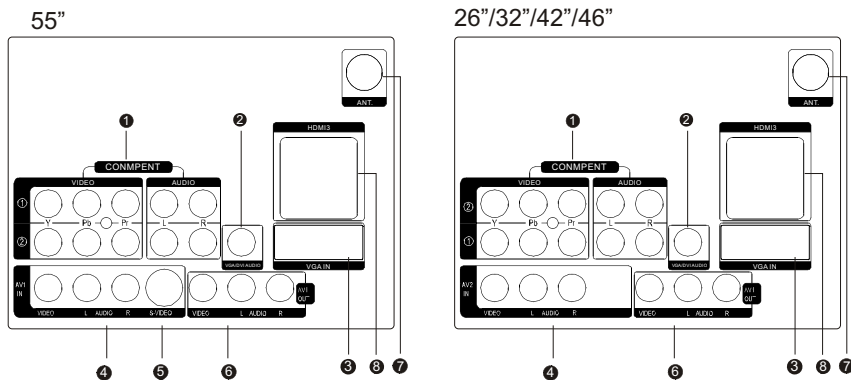

- 1.COMPONENT In: Connect a component Video/Audio device to these jacks
- 2.VGA/DVI AUDIO: Connect a VGA/DVI Audio device to these jacks
- 3.VGA IN: Connect the monitor output connector from a PC to the jack
- 4.AV1 In: Connect Video/Audio out from an Video/Audio device to these jacks
- 5.S-VIDEO: Connect S-Video out from a S-Video device to these jacks
- 6.AV OUT: Video/Audio output terminal
- 7.ANT In: Connect cable pr antenna signal to the TV, either directly or through your cable box
- 8.HDMI: Connect a signal to HDMI

# Remote control

## Battery loading

1. Slide open the cover of the battery compartment on the back of the remote controller.
2. Load two 7# (AAA) alkaline batteries in the compartment. (plus and minus poles to respective mark)
3. Replace the cover of the battery compartment.

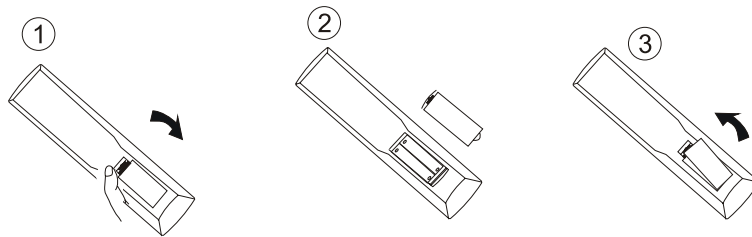

## Precautions

As strong light may interfere the signals, change your position to operate the remote controller if the television cannot be turned on or off as you expect.



Make sure that two AAA alkaline batteries are loaded. The batteries must be of the same type. The batteries must be located properly. The batteries are not rechargeable.

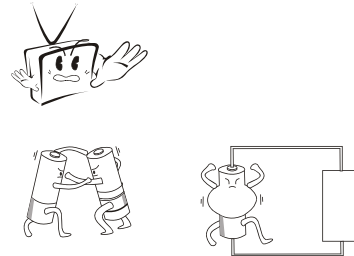

Keep the remote controller away from heat source or humid area to ensure effective performance of the remote controller.

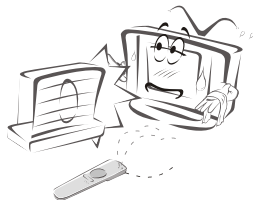

Make sure that there is no obstacle between the remote controller and television set.

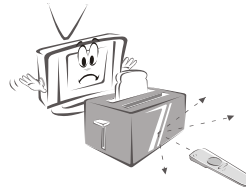

# Remote control function

- The remote control cannot be operated unless the batteries are properly loaded.
- When using the remote control, aim it at the remote control sensor on the TV.

## Function introduction

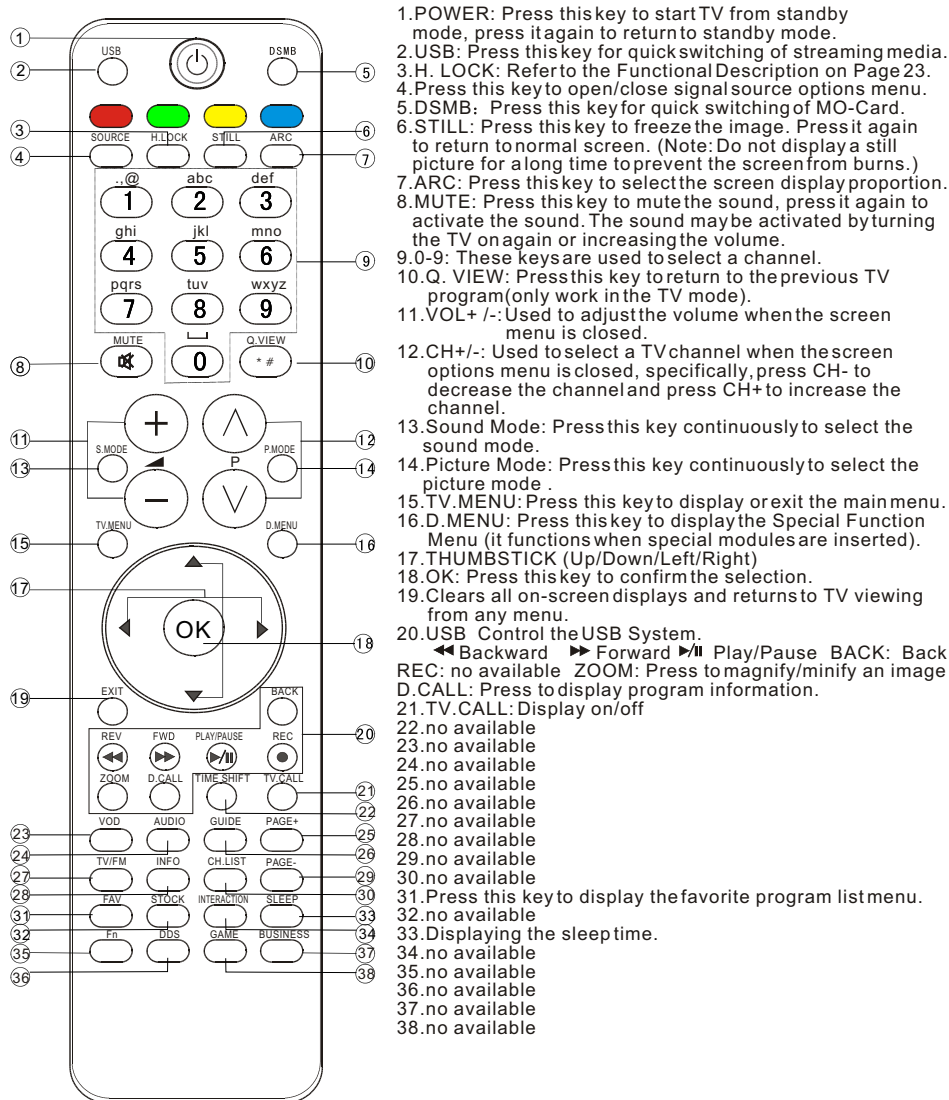

Note: From 22 to 38 (except 31 and 33), are belonged to DSMB function button. It will act when the module installed only. Pls refer to DSMB user's manual.



# External Equipment Connections

## Antenna Connection

- Antenna or Cable Service without a Cable Box Connections
- For optimum picture quality, adjust antenna direction if needed.

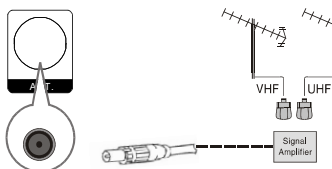
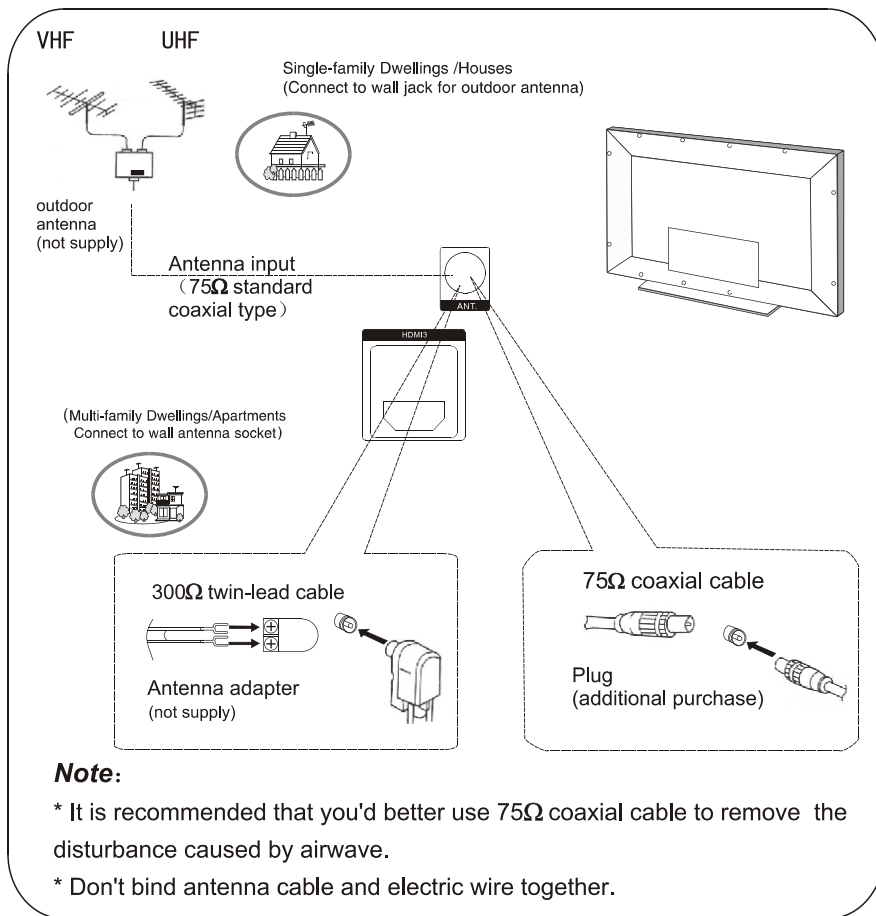

- To improve picture quality in a poor signal area, purchase and install a signal amplifier.
- If the antenna needs to be split for two TV's, install a "2-Way Signal Splitter" in the connections.
- If the antenna is not installed properly, contact your dealer for assistance.

## External Equipment Connections

NOTE: All cables shown are not included with the TV.

### Choose Your Connection

There are several ways to connect your television, depending on the components you want to connect and the quality of the signal you want to achieve. The following are examples of some ways to connect your TV.

Choose the connection which is best for you.

#### VCR Connection

- To avoid picture noise (interference), leave an adequate distance between the VCR and TV.

#### Connection Option 1

Set VCR output switch to channel 3 or 4 and then tune the TV to the same channel number.

#### Connection Option 2

1. Connect the audio and video cables from the VCR's output jacks to the TV input jacks, as shown in the figure.

When connecting the TV to VCR, match the jack colors (Video = yellow, Audio Left = white, and Audio Right = red).

If you connect an S-VIDEO output from VCR to the S-VIDEO input, the picture quality is improved; compared to connecting a regular VCR to the Video input.

2. Insert a video tape into the VCR and press PLAY on the VCR. (Refer to the VCR owner's manual.)

3. Select the input source with using the SOURCE button on the remote control, and then press CH+/- button to select the source, press the VOL+ button to confirm.

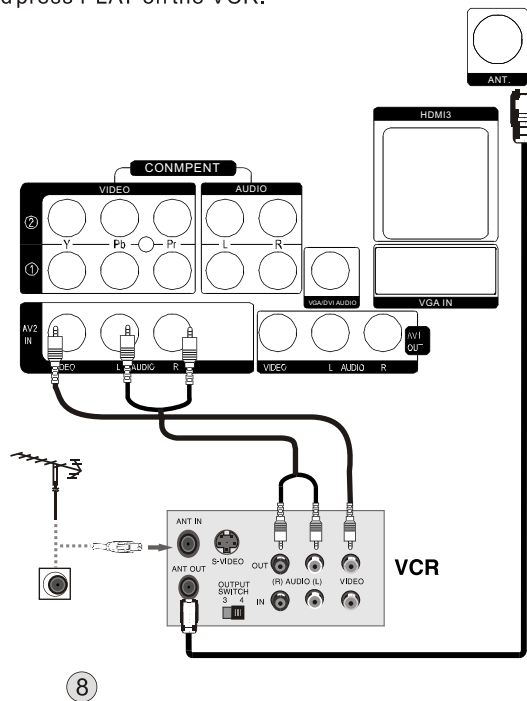

# External Equipment Connections

## DVD Setup

### How to connect

1. Connect the DVD video outputs (Y, Pb/Cb, Pr/Cr) to the COMPONENT (Y, Pb/Cb, Pr/Cr) input jacks on the TV and connect the DVD audio outputs to the AUDIO jacks on the TV, as shown in the figure.
2. If your DVD only has an S-Video output jack, connect this to the S-VIDEO input on the TV and Connect the DVD audio outputs to the AV IN jacks on the TV, as shown in the figure.

**NOTE:** If your DVD player does not have component video output, use S-Video.

### How to use

1. Turn on the DVD player, insert a DVD.
2. Use the S-Video button on the remote control to select S-VIDEO or YPbPr/YCbCr mode.
3. Press Play button on external equipment for program play.
4. Refer to the DVD player's manual for operating instructions.

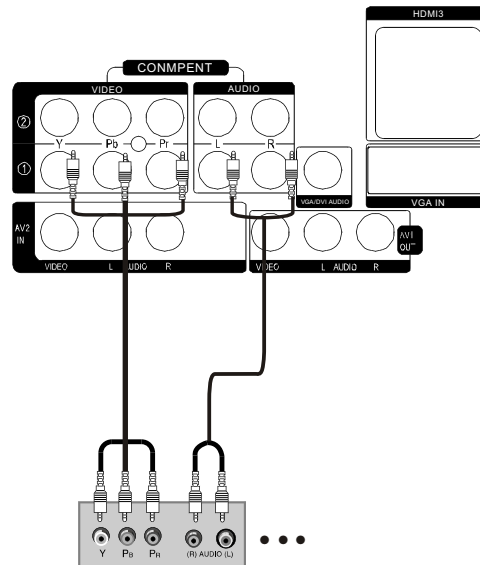

## HDMI or DVI Setup

-To watch digitally broadcast programs, purchase and connect a digital set-top box.

### How to connect

Use the TV's COMPONENT (Y, Pb/Cb, Pr/Cr) INPUT jacks, VGA or HDMI port for video connections, depending on your set-top box connections available. Then, make the corresponding audio connections.

### How to use

1. Turn on the digital set-top box. (Refer to the owner's manual for the digital set-top box.)
2. Use SOURCE on the remote control to select PC or HDMI (Y, Pb/Cb, Pr/Cr) mode.
3. Press Play button on external equipment for program play.

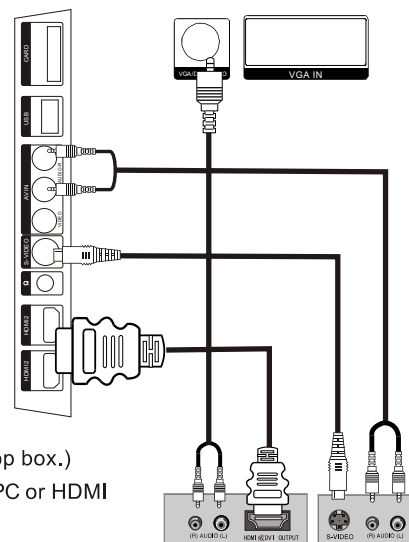

# External Equipment Connections

## PC Setup

### How to connect

1. Use the TV's V-GAIN port for video connections.

2. Then, make the corresponding audio connection. If using a sound card, adjust the PC sound as required.

### How to use

1. Turn on the PC and the TV.
2. Turn on the display by pressing the POWER button on the TV's remote control.
3. Use PC/DVI on the remote control to select VGA source.
4. Check the image on your TV. There may be noise associated with the resolution, vertical pattern, contrast or brightness in PC mode. If noise is present, change the PC mode to another resolution, change the refresh rate to another rate or adjust the brightness and contrast on the menu until the picture is clear. If the refresh rate of the PC graphic card can not be changed, change the PC graphic card or consult the manufacturer of the PC graphic card.

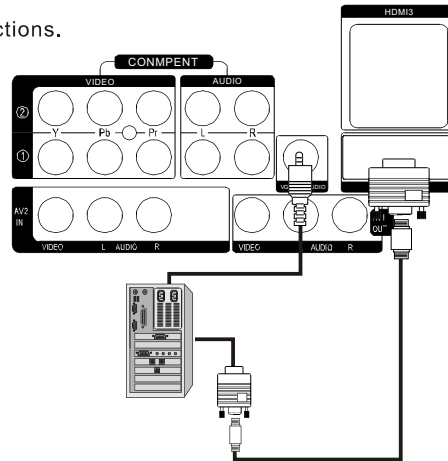

### NOTES:

- 1 Avoid keeping a fixed image on the TV's screen for a long period of Time. The fixed image may become permanently imprinted on the screen.
- 2 The synchronization input form for Horizontal and Vertical frequencies is separate.
- 3 To obtain the best picture, do not play the USB, YPbPr, HDMI or PC source at the same time.

## Monitor Out Setup

The TV has a special signal output capability which allows you to hook up a second TV or monitor.

Connect the second TV or monitor to the TV's AV OUT. See the Operating Manual of the second TV or monitor for further details regarding that device's input settings.

### Notes:

- YPbPr, PC, HDMI, S-Video input sources cannot be used for Monitor out.
- When connecting with external audio equipments, such as amplifiers or speakers, please turn the TV speakers off.

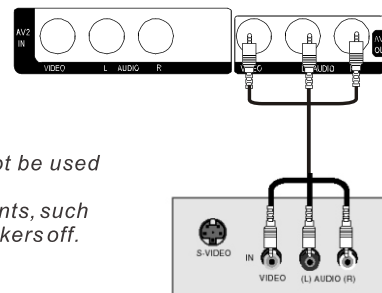

## External Equipment Connections

### Connecting Headphones

You can connect a set of headphones to your set if you wish to watch a TV program without disturbing the other people in the room.

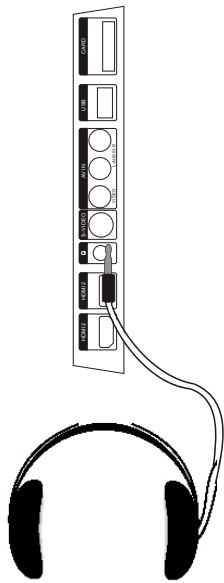

Plug a set of headphones into the 3.5mm mini-jack socket on the rear panel of the set.

**Note:**

- Prolonged use of headphones at a high volume may damage your hearing.
- You will not receive sound from the speakers when you connect headphones to the system.

### Power source

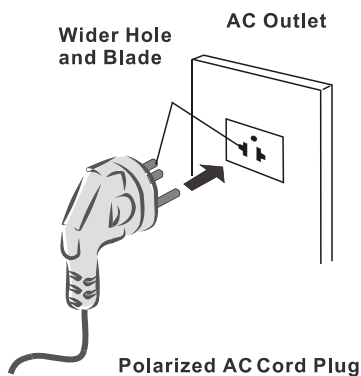

**TO USE AC POWER SOURCE**

Use the AC polarized line cord provided for operation on AC. Insert the AC cord plug into a standard polarized AC outlet.

**NOTES:**

- Never connect the AC line cord plug to other than the specified voltage. Use the attached power cord only.
- If the polarized AC cord does not fit into a non-polarized AC outlet, do not attempt to file or cut the blade. It is the user's responsibility to have an electrician replace the obsolete outlet.
- If you cause a static discharge when touching the unit and the unit fails to function, simply unplug the unit from the AC outlet and plug it back in. The unit should return to normal operation. Polarized AC Cord Plug.

## Switching ON/OFF the TV set

In the manual, the OSD (on screen display) may be different from your TV's because it is just an example to help you with the TV operation.

### Switching ON/OFF the TV set

1. First, connect power cord correctly and the power indicator will light.
2. Press POWER on the remote control again.
3. If you want to exchange to standing by status, please press down POWER on the remote control.
4. Disconnect the power supply or unplug the television if it is intended to completely cease the television performance.

### Choose the Menu Language

When you satisfied with your set for the first time, you must select the language which will be used for displaying menus and indications.

1. Press MENU and ◀/▶ to select Function menu.
2. Press ▲/▼ to select the Language.
3. Select a particular language by pressing ▶ repeatedly.
4. When you satisfied with your choice, press MENU to return to normal viewing.

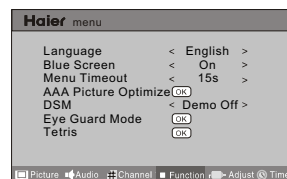

### Choose the Input Source

If the TV is not in TV mode, press SOURCE on the remote control unit, and signal source menu will be displayed on the TV screen (as shown in the right figure). Press ▲/▼ to select the TV option, and press ▶ or OK to confirm the switching to TV input terminal. After switching, the signal source menu disappears, and at the upper right corner of screen displays the information of current signal source.

Pressing this key repeatedly can exit from the signal source menu.

In case of no other operation, the signal source menu will automatically disappear upon reaching the OSD disappearance time preset in the main menu.

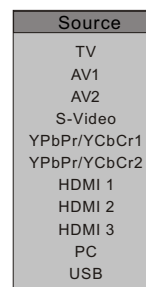

## Searching Channel

In this section, how to use the remote control to set channel is explained. You can also use buttons on the TV set to set channel.

### Channel Edit

1. Press MENU on the remote control unit or MENU on the TV's front panel to display main menu, and then press ◀/▶ to select Channel menu.

2. Press ▲/▼ to select the Channel Edit option, and then press ▶ to enter submenu.

**Search:** Press ▲/▼ to select the Manual Search option, and finally press ◀/▶ to start manual search. Upon finding a program, the search will automatically stop, and the program will be stored onto the current channel. You may stop the search by pressing OK or MENU.

**Fine Tuning:** Press ▲/▼ to select the Fine Tune option, and then press ◀/▶ to start UP or DOWN fine tuning until obtaining a relatively good picture effect. The fine tuning function is for the purpose of improving picture effect through fine tuning when that of a certain program is not good enough. Normally, the optimal picture effect can be obtained without fine tuning when watching TV programs, and fine tuning is to meet the need of adjusting a certain program.

**Color system:** Press ▲/▼ to select the Color Systems option, and then press ◀/▶ to select correct color system.

The TV is designed with three systems for your choice, i.e. Auto, PAL, SECAM and NTSC. Generally, the system is set as Auto and it is not necessary to make an adjustment. The system is normally set as Auto during auto search.

**Sound system:** The TV is designed with four systems for your choice, i.e. DK, M, BG and I. Generally, it is not necessary to adjust the system. The system is normally set as DK during auto search.

**Skip:** When the skip is set ON, the channel will be skipped when pressing P ▲ or P ▼ and only can be selected by pressing 0-9 numerical keys.

#### If you want to recover the skipped channel

1. Use Direct-digit Choosing button to select the number of the channel to be recovered.
2. Do the above steps again.
3. Press ▶ to set Skip as Off.

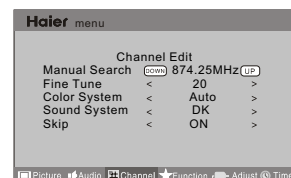
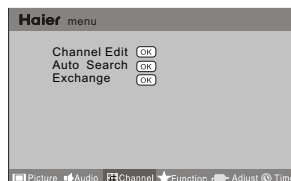

# Searching Channel

## Automatic search

1. Press MENU on the remote control to display main menu, and then press ◀/▶ to select Channel menu. (Note: Only when Tuning Lock in the H. Lock menu is Off can the Channel menu be selected.)

2. Press ▲/▼ to select the Auto Search option, and then press ▶/OK to enter submenu.

3. Press ▲/▼ to select the Storage from option, and then press ◀/▶ to set the found from which to be stored, press ▲/▼ to select the Auto Search option, press ▶/OK to enter the auto search menu, afterwards press ▶ to select the Confirm option, and finally press OK to confirm the starting of auto search.

4. During auto search, the scale value on the progress bar is continually increasing, indicating the auto search is in progress. After finishing the auto search, the TV will play the channel starting the auto search. To stop the search in halfway, just press MENU/OK, and the TV will play the first searched channel.

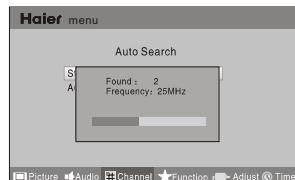
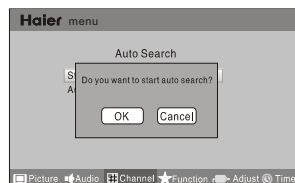
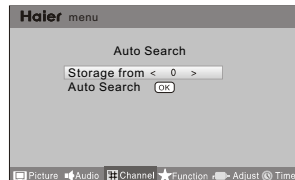
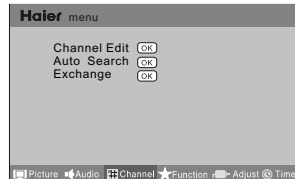

## Exchange

1. Press MENU on the remote control unit or MENU on the TV's front panel to display main menu, and then press ◀/▶ to select Channel menu.

2. Press ▲/▼ to select the Exchange option, and then press ▶ to enter its submenu.

3. Press ▲/▼ to select the To Channel option, and then press ◀/▶ to set the found to be exchanged to.

4. After adjusting the current channel and the found to be exchanged to, press ▲/▼ to move the cursor to the Exchange option, and then press ◀/▶ to start exchange and exchange the program on current channel to the channel you set for exchange.

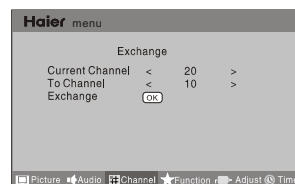



## Watching TV Program

---

You can watch TV program in a presetting channel.

### How to select the desired program

---

- 1 Using Program number buttons  
Directly enter the channel number with the numeric keypad on the remote control.  
If to select channel numbers of double-digital or three-figure, press continuously the numeric buttons in three second.
- 2 Using CH+/- buttons  
Press CH+ to select a channel number in number increasing direction.  
Press CH- to select a channel number in number decreasing direction.

### How to select the desired sound

---

Press VOL-/+ buttons on the remote or the front of the TV set to adjust the volume level. The range is 0~100.  
When the volume buttons are pressed the volume level is displayed automatically on the TV screen.

### Mute Setting

---

1. Press MUTE button on the remote control and a icon will display on the screen. At this time, the sound of the TV set is turned off.
2. If you want to recover the sound, press MUTE button again or directly press VOL+ button.

### Quick program view

---

1. Suppose that you previously watched a TV program on Channel 8, but now you are watching a TV program on Channel 18 (as shown in the right figure).
2. If you want to return to Channel 8, just press "Q. VIEW (Flashback)" once.
3. If you want to return to Channel 18 again, just press "Q. VIEW (Flashback)" once again.

Note: This function is only available in TV mode.

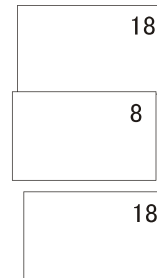

## Picture Control Functions

This means the adjustment of specific contents in the picture, if already in normal condition, it is not necessary to make any adjustment.

Due to different TV signal inputs, some items may need to be adjusted. The following makes a description by only taking TV signal as an example.

### How to select the picture mode

1. Press MENU to display main menu on the screen, and then press ◀/▶ to select the Picture menu, afterwards press ▲/▼ to enter the option to be adjusted.

2. Press ▲/▼ to move the cursor to the option to be adjusted, and then press ◀/▶ to select Standard/Bright/Soft/User/Eye Guard mode.

You can also press P.MODE on the remote control to select Standard/Bright/Soft/ User/Eye Guard mode.

Standard: The picture brightness and hue are moderate.

Bright: The picture is vivid, bright and dynamic.

Soft: The picture is soft and in light color.

User: The picture effect is set by yourself to your preference.

Eye Guard(The option does not exist when using a USB device.): In line with the change of using environment, the TV set will adjust automatically the image display mode to protect viewers' eyes from any negative impact.

### How to customize your own picture status

1. Press MENU to display main menu on the screen, and then press ◀/▶ to select the Picture menu, afterwards press ▲/▼ to enter the option to be adjusted.

2. Press ▲/▼ to move the cursor to the option to be adjusted, and then press ◀/▶ to adjust it to your desired effect.



**Brightness:** This will adjust the light output of the complete picture, which will mainly affect the darker areas of the picture.

**Contrast:** This will adjust the intensity of bright parts in the picture but keep the dark parts unchanged.

**Sharpness:** This will adjust the sharpness of fine details in the picture.

**Hue(select able in NTSC mode only):** Allows you to select the color mix (Tine) of the picture.

**Chroma:** This will adjust the saturation level of the colors to suit your personal preference.

**Picture Mode:** Select the mode of picture(Standard/Bright/Soft/User/Eye Guard)

**Palette:** Press ▲/▼ to select the Palette option, and then press ▶ to enter its submenu, and finally press ▲/▼ to select a toner pattern from six patterns (User, Standard, 6500K, 7300K, 8500K and 9300K) to your color preference. Normally, the Standard mode is selected.

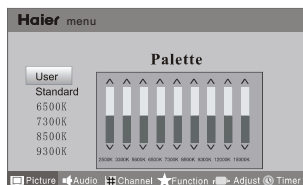

If the User mode is selected, press ◀/▶ to enter the palette menu, (as shown in the right figure), and then press ◀/▶ to select a benchmark in the range of 2500K15000K from warm color to cold color, afterwards press ▲/▼ to adjust; if a different benchmark is selected for adjustment, the original adjustment data will be automatically cleared.

**Reset:** Return to factory default settings.

# Sound Control Functions

## How to choose audio mode

1. Press MENU to display main menu on the screen, and then press ◀/▶ to select the Audio menu, afterwards press ▲/▼ to enter the option to be adjusted.
2. Press ▲/▼ to move the cursor to the option to be adjusted, and then press ◀/▶ to select User/Standard/Music/Theater mode.

User: A spare setting that can be adjusted to personal tastes.

Standard: Normal sound with moderate bass and treble setting.

Music: Designed the sound to best suit music programs.

Theater: Enables extra bass and treble to enhance the movie experience.

You can also press S.MODE button on the remote control to select User, Standard, Music and Theater mode.

## How to customize your own audio status

1. Press MENU to display main menu on the screen, and then press ◀/▶ to select the Audio icon, afterwards press ▲/▼ to enter the option to be adjusted.
2. Press ◀/▶ to adjust.

### Volume

Press ◀/▶ to adjust the volume of a TV program.

### Balance

This will adjust the output of the right and left speakers to obtain the best stereo reproduction for your listening position.

The intermediate value is 0. When indication value of Balance increases toward 50, sound of the right and left speakers becomes stronger and weaker, respectively. When indication value of Balance decreases toward -50, sound of the right and left speakers becomes weaker and stronger.

### Sound Mode

This select the modes for sound reproduction dependent on the broadcast signals or signals from external inputs received.

Select the mode of sound (User/Standard/Music/Theater).

If the User mode is selected, press ▶ to enter the sound mode menu, (as shown in the right figure), and then press ◀/▶ to select a benchmark in the range of 50-15K from bass to treble, afterwards press ▲/▼ to adjust, if a different benchmark is selected for adjustment, the original adjustment data will be automatically cleared.

### SRS TS XT

The surround sound feature expands the audio listening field wider and deeper to create exceptional sound quality from the Tv's speakers.

### AVL (Automatic Volume Limit)

This will reduces the differences in volume level among broadcasters.

### MAXXBass

To adjust the superbass. Press ◀/▶ to select superbass on or off.

**Reset:** Return to factory default settings.

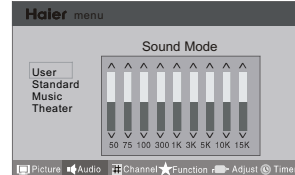
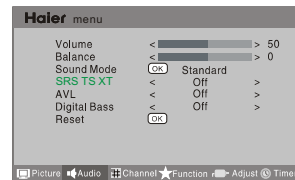

# Timer Functions

## Setting of Current Time

The current time is calculated from the moment upon turning the TV on. At first, check whether the time indicated on the TV's clock is consistent with the standard time of your time zone; if not, adjust the clock as follows:

1. Press MENU on the remote control unit or MENU on the TV's front panel to display the main menu, and then press ◀/▶ to select the Time menu, afterwards press ▲/▼ to select the Current Time option.
2. Press ▶ to set hour and minute.
3. Press ▲/▼ to adjust the time.
4. After finishing time setting, press OK or MENU to confirm.

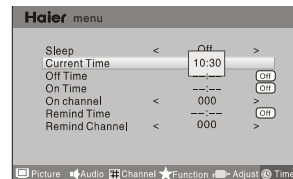

## Sleep Setting

1. Press MENU on the remote control unit or MENU on the TV's front panel to display the main menu, and then press ◀/▶ to select the Time menu, afterwards press ▲/▼ to select the Sleep option.
  2. Press ◀/▶ to set your desired time.
- Pressing ◀/▶ allows you to select the time from the following options in turn: off, 5min, 10min, 15min, 30min, 45min, 60min, 90min, 120min, 180min and 240min.

Notes:

1. You may also set the sleep function by operating the Sleep key on the remote control unit.
2. If the Sleep function is set OFF, the function is not available. If a time period is selected, the TV will automatically enter standby mode upon reaching the preset time, and will resume work when POWER is pressed.
3. If the Sleep function has been set, press SLEEP once, the remaining time to sleep will display on the screen, if you press SLEEP once again before the display disappears, the sleep time set last time will be cleared and new time can be set.
4. During 1min before the TV enters sleep mode, there will be count-down prompt such as Sleep 59s on the screen until the TV is off. During the 60s, the user may change the time or cancel the Sleep function by operating the SLEEP key.

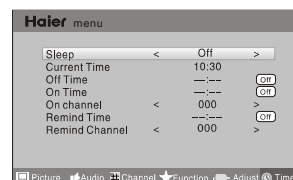

# Timer Functions

## Setting of ON/OFF Time

This function allows the TV to automatically turn on or enter standby mode upon reaching the preset time.

1. Press MENU on the remote control unit or MENU on the TV's front panel to display the main menu, and then press ◀/▶ to select the Time menu, afterwards press ▲/▼ to select the On Time or Off Time option.
2. Press ◀/▶ to enter the setting screen, and then press ▲/▼ to select ON or OFF, if you select ON, press ▶ to set hour and minute. ON indicates the On/Off Time function is enabled while OFF indicates the function is disabled.
3. After finishing time setting, press OK or MENU to confirm.

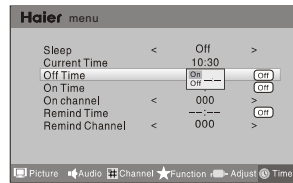

**Note:**  
After setting the On/Off Time function, if the TV is AC off or forcible DC off, the function will be automatically cleared.

## Setting of On Channel

This function is used in combination with the On/Off Time function. When the TV turns on upon reaching the On time, it automatically enters the preset channel.

1. Press MENU on the remote control unit or MENU on the TV's front panel to display the main menu, and then press ◀/▶ to select the Time menu, afterwards press ▲/▼ to select the On Channel option.
2. Press ◀/▶ to set the On Channel or OFF.

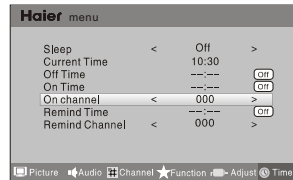

## Setting of Remind Time and Remind Channel

The remind time and remind channel functions allow the TV to automatically enter the preset channel at preset time. If the TV is AC off or forcible DC off, the preset time will be cleared.

1. Press MENU on the remote control unit or MENU on the TV's front panel to display the main menu, and then press ◀/▶ to select the Time menu, afterwards press ▲/▼ to select the Remind Time option.
2. Press ▶ to enter the setting screen, and then press ▲/▼ to select ON or OFF, if you select ON, press ◀/▶ to set hour and minute, and then press ▲/▼ to adjust time.
3. After finishing time setting, press OK or MENU to confirm.
4. Press ▲/▼ to select the Remind Channel option, and press ◀/▶ to set the found.

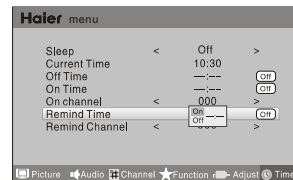

# Function Menu

## Function Menu Set

1. Press MENU on the remote control unit or MENU on the TV's front panel to display the main menu, and then press ◀/▶ to select the Function menu.

2. Press ▲/▼ to select the option to be adjusted, and then press ◀/▶ to adjust it.

**Language:** Two languages (i.e. Simplified Chinese and English) are available for your choice.

**Blue screen:** Press ◀/▶ to set ON or OFF, if you select ON, the TV screen will be blue if no signals are available.

**Menu timeout:** The option is for adjusting the menu display time. Press ◀/▶ to set the desired time (5-15s).

### AAA Picture Optimize:

1. Press MENU on the remote control unit to display the main menu, and then press ◀/▶ to select the Function menu.
2. Press ▲/▼ to select the AAA Picture Optimize option.
3. Press ▶ to enter the submenu.
4. Press ▲/▼ to select the option to be adjusted, and then press ◀/▶ to adjust it.

**DSM:** DSM is a picture effect demo function. The image quality of pictures in the frame and on the right is improved for DSM has made dynamic trace processing on their hue and contrast. The picture out of the frame is common without any processing.

Press ◀/▶ to set OFF, I, II.

Note: When the demo function is activated, once the user changes channel, switches aspect ratio or signal source, or searches for channels again, etc., this function will be automatically disabled.

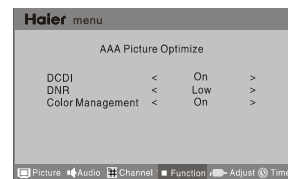
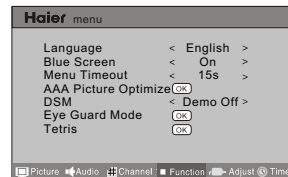

## Function Menu

**Eye Guard Mode:** In line with the change of using environment, the TV set will adjust automatically the image display mode to protect viewers' eyes from any negative impact.

1. Press **▶** to enter the sub-menu (see the picture on left)  
 2. Press **▲ / ▼** to select the option to be adjusted, and then press **◀ / ▶** to set up.

**Power On E.G. Mode:** Set the power on time in the Standard Mode/Eye Guard Mode/ Curtain Mode according to the usage environment.

**Change Ch. E.G. :** When you switch to another channel, the image stays still to avoid any negative impact to your eyes.

**Watching E.G. :** When watching TV, you can adjust the image display mode in line with the using environment.

**Watching E.G. Delay :** You can choose between entering the Eye Guard Mode instantly or 3-5 seconds later.

**Tetris:** After accessing the Function Menu, press **▶** to enter (see the picture below).

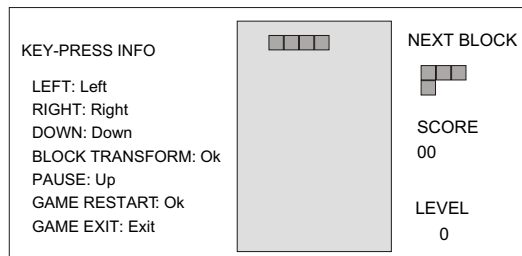
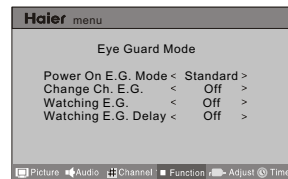

## Adjust Menu

The TV can be used as a display, and you may adjust relevant settings. The operating method of various menus is the same as that described for TV signal. The following are operating methods that different from that for TV signal.

When the TV is used as a display, you may set and adjust its picture effect by the following steps.

Press SOURCE to switch the signal input to PC mode.

1. Press MENU to display the screen main menu, and then press ◀ / ▶ to select the Adjust menu as shown in the right figure.

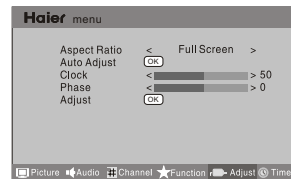

2. Press ▲ / ▼ to select the option to be adjusted.

3. Press ◀ / ▶ to adjust it.

### Aspect Ratio

Press this key to select the screen display proportion.

### Auto Adjust

This is used to reset the default setting parameters.

### Clock

This is used for adjusting H Position and V Position as well as relative parameters in **PC** modes.

### Phase

This is used for adjusting the phase of pixel clock in PC mode.

### Adjust

Vertical and Horizontal position of picture can be adjusted in this item.

### Precautions:

1. When making H-Size, V-Size, H-Position or V-Position adjustment, there sometimes may be abnormalities in case of a large adjustment range, which is not a fault but for the signal sync out of range, and the picture will become normal by reverse adjustment.

2. In PC mode, there are only two aspect ratios (4:3, full screen) available.

3. There will be a display proportion of "Dot By Dot" when the signal is 1080P 50Hz in the source of YPbPr or HDMI. This proportion is for Full-HD panel test in factory. Please do not use this proportion, otherwise the display will be distortionary.

(Only for L42M9/ L46M9/ L55M9/ LB42R3/ LB46R3/ LP55R3 )



## Lock Setup

The television has the function of security default lock. Password needs to be entered when the program lock mode is to be set.

### How to use the password function

Press H. LOCK, the TV screen will display Enter Password to prompt the user to enter a correct password by pressing corresponding numerical keys; if the password is correct, the user enters the Lock Set menu; if incorrect, the user is required to enter a password again.

If there is no operation for a few seconds, the display will automatically disappear.

The Lock Set menu is as follows:

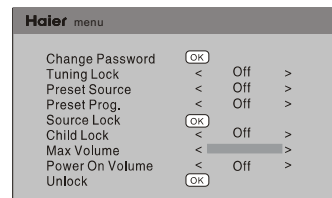

### To set new password

After entering the Lock Set menu, press ▲ / ▼ to select the Change Password option, and then press ◀ / ▶ to display the Change Password menu, afterwards enter a new 4-digit password by pressing numerical keys and repeat entering this password once, and finally select the option to be confirmed and press MENU to confirm, indicating the successful change of password.

If the user does not want to change the password in halfway, he may press MENU to exit from this menu.

Note: The initial password is 0000, and the password setting will not be changed after executing the Unlock option.

### Tuning Lock

Press ▲ / ▼ to select the Tuning Lock option, and then press ◀ / ▶ to set ON or OFF.

(If set ON, th Tuning Menu is not available in TV mode. To make any operation related to the Tuning Menu, it is necessary to enter the Lock Set menu to set Tuning Lock OFF or execute the Unlock option.)

### Preset Source Setting

Preset Source may be set as Off, TV, AV1, AV2, S-Video, YPbPr/YCbCr, HDMI, PC and USB. When the Preset Source is set as TV, after entering the Preset Channel menu, press ◀ / ▶ to select the preset channel, and the channel will be forcibly switched to the preset one upon turning the TV on; when the Preset Source is set as other signal sources, the TV will be forcibly switched to the preset source upon turning on. For example, when the Preset Source is set as YPbPr/YCbCr, the TV will be switched to YPbPr/YCbCr upon turning on; when set as OFF, the preset function will be closed.

## Lock Setup

---

### Preset Channel Setting

Only when the Preset Source is set as TV can the Preset Channel option be available. Press ◀/▶ to select preset channels from 0-254.

### Source Lock

This function is used to prohibit watching a program from various external inputs, e.g. AV, S-Video and PC, etc. Press ▲/▼ to select a certain option, and then press ◀/▶ to set an external input lock ON or OFF. If an external input lock is set ON, after entering this mode, the screen will display blue background with muting and a prompt Source Lock; during Source Lock prompt, Source Lock will remain if there is no other display on the screen. To watch a program from a locked external input, just enter Source Lock submenu to set corresponding status as OFF or execute the Unlock option in the Lock Set menu.

### Child Lock Setting

Press ▲/▼ to select the Child Lock option, and then press ◀/▶ to set ON or OFF. If set ON, this control key will not respond, and the screen will display Child Lock when the key is pressed; if no other operation is made, the display will automatically disappear later. To resume Child Lock function, just enter the Lock Set menu to set Child Lock OFF or execute the Unlock option.

### Max Volume Setting

Press ▲/▼ to select the Max Volume option, and then press ◀/▶ to freely adjust the max volume within the range of 0~100. After finishing the setting, the max volume in the Volume menu will not exceed the preset max volume; for example, if the preset max volume is 30, the volume in the Volume menu can not be increased any longer upon reaching 30; if the preset max volume is less than the value in the Volume menu, the latter will decrease along with the decrease of preset max volume.

### Power on Volume Setting

Press ▲/▼ to select the Power on Volume option, and then press ◀/▶ to freely adjust the volume within the range of 0~100. After setting a certain value (except OFF), the TV plays a program with the preset volume upon turning on, when set as OFF, upon turning on, the TV plays a program with the volume before turning off last time.

### Unlock Setting

Press ▲/▼ to select the Unlock option, and then press ▶ to clear all the lock settings, namely set all the lock setting options as OFF; the Preset Channel is set as OFF and max volume returns to 100 (except password).

## Streaming Media Playing System

---

Note: The diagrams in the following section are schematic and only for your reference. Please see the actual product if necessary.

### Installation of Streaming Media System

1. Supported file formats:

- 1) Picture: \*. jpg, \*. bmp, \*. png files;
- 2) Music: \*. Mp3 files;
- 3) Movie:
  - MPEG4: \*. avi files in accordance with Divx4. x/5.x Protocol;
  - MPEG2: some \*. mpeg files;
  - MPEG1: \*. dat and some \*. mpeg files;
- 4) Text: \*. Txt.

Note: Due to the particularity of file coding, some files may be unable to be read.

2. Supported equipment:

Support the equipment that supports Mass Storage Protocol and whose file system is FAT/FAT16/FAT32, such as some USB disks, mobile hard disks, card readers, MP3 players and digital cameras. If USB equipment could not be identified due to unsupported file system, please format the equipment to the above-mentioned file system;

3. The external card reader supports most of the digital cards in the current market; the types of digital cards that can be read are relevant to the performance of selected card reader; you may attach standard mobile hard disks (working voltage 5.0V, working current not higher than 500mA); during media playing, do not pull out storage media, otherwise it may cause system halt, damage the files in storage media or damage USB equipment; sometimes, the TV may halt due to overhigh information error rate, in which case you should restart the system; there are a lot of nonstandard USB mobile equipment in the market, they may not be identified when connected to the streaming media playing system; the above phenomena may also occur on computers and are not the TV's fault.

4. To achieve smooth playing, ensure the following:

- 1) The file code rate should be lower than 300KB/S;
- 2) Due to the limitation of USB signal transmission distance, it is recommended not to use USB patch cord, in case of using the cord, make sure that its length is not over 1m;
- 3) Use high-speed USB equipment in conformity with USB2.0 Interface Standard; if USB equipment in conformity with USB1.1 Interface Standard is used, the playing may be unsmooth.

5. Although many movie files are with such postfixes as avi and mpeg, actually there are several formats in the files; however, the TV can only play some files in avi and mpeg formats. Some files with the postfix "dat" are not movie files, but data files commonly used in computers, and they can not be played as movies.

## Streaming Media Playing System

### Installation of Streaming Media System

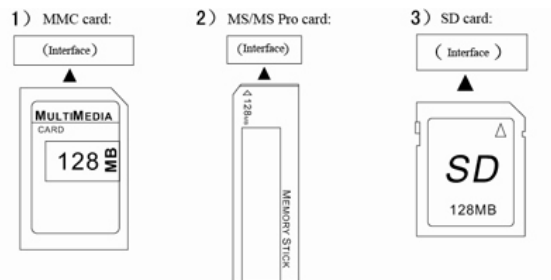

#### Notes:

1. Time of insertion: insert a card into corresponding interface 2s after starting the streaming media. Do not start the streaming media system with a card;
2. After inserting a card, the screen displays the inserted partition's letter in USB interface mode, indicating the card has been identified, at which time you can play or make other operations;
3. There are many types of digital cards in the market. It is recommended to use quality products from qualified manufacturers. In case of reading difficulty or restricted reading speed, please change to another card.

#### Data Protection of USB Digital Card

1. Do not remove or touch the rear part of digital card when it is working, otherwise it may cause data loss or damage to the card.
2. Please insert the digital card in a correct way each time you use streaming media.
3. Haier shall not be held liable for any data loss or quality problems of digital cards.



#### Warning:

After the use of a digital card or USB disk, please place it in a safe place to avoid any danger resulting from being swallowed by a child.

## Streaming Media Playing System

### Start/Exit Streaming Media Playing System

1. Press USB on the remote control unit to select the streaming media function.
2. Insert USB equipment into corresponding USB interface 2s after starting the system.
3. After entering the system menu, press ◀/▶ on the remote control unit to select the required USB equipment, and then press ▲/▼ on the remote control unit to select the required file.
4. Press OK to enter the selected file.
5. To exit the streaming media playing system and watch a TV program, you must return to the streaming media main menu at first (to protect equipment), and then press SOURCE to select TV or directly press USB to return to the TV mode.

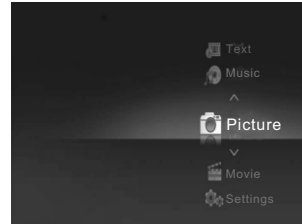

#### Notes:

1. While playing non-picture or non-movie files, press MENU or SOURCE, the TV screen will be black and display corresponding menu; moreover, in USB mode, only when playing a movie can such shortcuts as Picture Mode, etc. work, and only MUTE can work in other menus. After entering the Picture option, pictures without thumbnails will not be accompanied with a small-window thumbnail, and pictures in both bmp and png formats do not have thumbnails. In addition, it's best not to operate menus in the progress of opening pictures to avoid system chaos.
2. If a USB and a digital card are inserted at the same time and each has a partition letter, the USB will be defaulted as Disk C whichever is inserted first.
3. While playing a USB or digital card, press SOURCE, the screen picture will return to USB main interface, and only at this time can you switch corresponding signal sources by pressing SOURCE again.
4. While playing a file in txt format, press MENU, the screen will directly return to txt main menu.

### Operating Method of Streaming Media Menu

1. Press ▲/▼ to scroll through main menu or submenu and select your desired option.
2. Press OK to confirm your selection.
3. Press REV/FWD to achieve the FF (fast forward) and FB (fast back) of the movie or music being played.
4. Press PLAY/PAUSE to pause playing, and press it again or press OK to continue playing.
5. Press ZOOM to magnify pictures; in zoom mode, press ◀/▶ and ▲/▼ to move the picture.
6. Press D.CALL to display or exit the screen display information while playing.
7. Press BACK to stop playing, or return to the previous menu, and press BACK repeatedly to return to the main menu.
8. After the on-screen display disappears, press ZOOM to magnify the image; then press ▲/▼/◀/▶ to move the image under the magnified mode.

## Streaming Media Playing System

### Playing a Picture

1. After entering USB main interface, press ◀/▶ to select a harddisk partition, and then press ▲/▼ to select the Picture option.
2. Press OK to confirm the selection and enter the picture playing interface.
3. Press ◀/▶ to change page, and press ▲/▼ to select the picture you want to play, and then press OK to enter the playing display interface.

Press ZOOM to magnify the picture, and then press ◀/▶/▲/▼ to move the picture.

Press ◀/▶ to select the last or next picture.

Press ▲/▼ to rotate the picture.

4. To exit playing, just press BACK repeatedly.

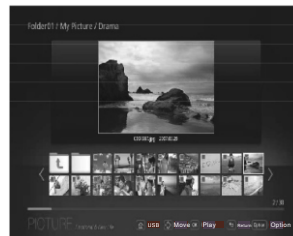
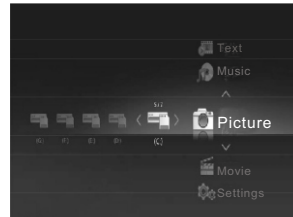

### Playing a Movie

1. After entering USB main interface, press ◀/▶ to select a harddisk partition, and then press ▲/▼ to select the "Movie" option.
2. Press OK to confirm the selection and enter the movie playing interface.
3. Press ◀/▶ to change page, and press ▲/▼ to select the movie you want to play, and then press OK to enter the playing display interface.

Press ◀/▶ to select the last or next movie.

Press D.CALL to display relevant information while playing.

4. To exit playing, just press BACK repeatedly.

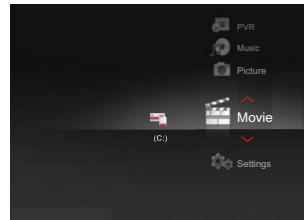

#### Note:

The menu display varies with the number and names of files in your equipment.

## Streaming Media Playing System

### Playing Music

1. After entering USB main interface, press ◀/▶ to select a harddisk partition, and then press ▲/▼ to select the Music option.
2. Press OK to confirm the selection and enter the music playing interface.
3. Press ◀/▶ to change page, and press ▲/▼ to select the music you want to play, and then press OK to play the music.
4. To exit music playing, just press BACK repeatedly.

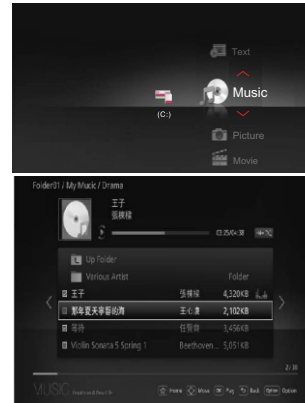

### Text

1. After entering USB main interface, press ◀/▶ to select a harddisk partition, and then press ▲/▼ to select the Text option.
2. Press OK to confirm the selection and enter the text playing interface.
3. Press ▲/▼/◀/▶ to select the text you want to read, and then press OK to play the text reading interface. Press ▲/▼ to change page, and press BACK to exit the reading interface.
4. To exit the Text mode, just press BACK repeatedly.

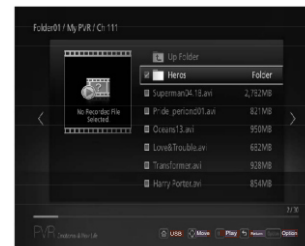

### Settings

1. After entering USB main interface, press ▲/▼ to select the Settings option.
2. Press OK to confirm the selection and enter the settings selection interface, and then press ▲/▼ to select the required options.

#### Photo Slide Time

Set the scan speed of pictures to be scanned in slide form.

There are three options (Slow/Middle/Fast). Press ◀/▶ to select the desired option.

#### Movie SubTitle

Set movie subtitle enable or disable.

Press ◀/▶ to select the desired option.

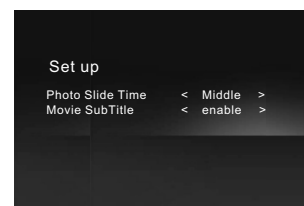

## **Maintenance**

---

Early malfunctions can be prevented. Careful and regular cleaning can extend the amount of time you will have your new TV. Be sure to turn the power off and unplug the power cord before you begin any cleaning.

### **Cleaning the Screen**

1. Here's a great way to keep the dust off your screen for a while. Wet a soft cloth in a mixture of lukewarm water and a little fabric softener or dish washing detergent. Wring the cloth until it's almost dry, and then use it to wipe the screen.
2. Make sure the excess water is off the screen, and then let it air-dry before you turn on your TV.

### **Cleaning the Cabinet**

To remove dirt or dust, wipe the cabinet with a soft, dry, lint-free cloth. Please be sure not to use a wet cloth.

### **Extended Absence**

If you expect to leave your TV dormant for a long time (such as a vacation), it's a good idea to unplug the power cord to protect against possible damage from lightning or power surges.



## Troubleshooting

For the sake of time and cost, it is strongly recommended that you check out the problem by yourself according to the instructions listed hereunder before contacting the after-sales service for technical assistance.

<b>Problem</b>	<b>Possible remedies</b>
No picture, no sound	Turn on the power supply; Properly plug the TV set to the power socket; Check to see if the power cable of other appliance is plugged in the TV set. Make sure that the power cable of the TV set is properly connected.
Good picture, no sound	Depress the volume button; Check out the audio frequency input signals.
Failure of remote controller	Check to see if the remote controller display receiving window are blocked by other objects and if batteries are properly loaded.
No color, weak color or poor picture	Designate the item of color from the Picture menu and depress the volume button; Keep the display and VCR separate a reasonable space; Activate some functions to store picture brightness; Make sure that the display and signal source are available and turned on.
Excessive brightness or darkness	Adjust brightness or contrast.
Picture too big or small	Adjust the setup of sizes.
One speaker failure	Balance the sound in the menu.
Slight sound from display	It is a normal phenomenon.

**Note:** Do not leave the television with static picture in an extended period as it may result in residual image on your television screen.

**Note:** Production of the screen requires high and precision technologies. However, there might be some dark or bright (red, blue or green) spots, or some anomalistic stripes or spots. This is not defect. If the TV set is used in an area 2,400 meters above the sea level where the air pressure is below 750hpa, the picture on the screen may be affected and a muffled sound might be produced. These phenomena might happen in the area 1,500 meters above the sea level. This is resulted from difference between air pressures inside and outside the display. This is not a defect covered by the limited warranty.

# Specifications

## Basic specification and parameter

Power	~ 150-240V 50/60Hz
Color System	PAL, NTSC, SECAM
Sound System	DK, BG, I, M
Video input	USB, AV (CVBS) , S-VIDEO, YPbPr/YCbCr, HDMI or DVI, VGA
Environmental condition	<p>Operating temperature range: 5°C ~ +35°C            Operating humidity range: 20%-80%            Storage Temperature: -15°C ~ +45°C            Storage Humidity: 5%-90%, non-condensing</p> <p>If the storage temperature is lower than 0 °C, please first lays the machine aside after in the operating temperature environment carries on restores 2 hours, then electrifies the use again, protects your television not to receive the damage.</p>
Accessories	<p>Owner's manual x1            Remote Control x1            Alkaline battery x2</p>

## Product main size (contain stand)

Model	Power Consumption	Net Size(L x W x H)	Net Weight
26"	90W	662x200x500mm	8.7Kg
32"	130W	796x230x590mm	11.8Kg
42"	200W	1020x290x724mm	27.5Kg
46"	250W	1122x330x789mm	29.0Kg
55"	300W	1328.6x365x895mm	39.0Kg

**NOTE** :Design and specifications are subject to change without notice.  
 The dimension in this manual is a approximation.

# Format

Recommendatory HDTV/SDTV(YPbPr/YCbCr) format:

Sequence Number	Format	Refresh Frequency ( Hz )
1	480i/480p	60
2	576i/576p	50
3	720p	50/60
4	1080i/1080p	50/60

Recommendation PC connection input format:

sequence number	Format	H-Frequency ( KHz )	V-Frequency ( Hz )
1	640*480@60Hz	31.5	60
2	800*600@60Hz	37.88	60
3	1024*768@60Hz (Recommendatory)	48.36	60

Recommendation DVI connection input format:

Sequence Number	Resolution	Refresh Frequency ( Hz )
1	640*480	60
2	800*600	60
3	1024*768	60

Recommendation HDMI connection input format:

Sequence Number	Format	Refresh Frequency ( Hz )
1	480i/480p	60
2	576i/576p	50
3	720p	50/60
4	1080i	50/60

---

# Haier®

01  
0090509260A

## Free Manuals Download Website

<http://myh66.com>

<http://usermanuals.us>

<http://www.somanuals.com>

<http://www.4manuals.cc>

<http://www.manual-lib.com>

<http://www.404manual.com>

<http://www.luxmanual.com>

<http://aubethermostatmanual.com>

Golf course search by state

<http://golfingnear.com>

Email search by domain

<http://emailbydomain.com>

Auto manuals search

<http://auto.somanuals.com>

TV manuals search

<http://tv.somanuals.com>