

Haier

PLASMA TV OWNER`S MANUAL MODELS: **P42A1-AK**

Please READ this manual carefully before operating your TV, and retain it for future reference.

Haier

Haier

Haier

Congratulations on your purchase, and welcome to the "family"!

Dear Haier product owner:

Thank you for your confidence in Haier. You've selected one of the best-built, best-backed products available today. We'll do everything in our power to keep you happy with your purchase for many years to come.

As a member of the Haier "family," you're entitled to protection by one of the most comprehensive warranties and outstanding service networks in the industry.

Thanks for investing in a Haier product.

Warning



WARNING

**RISK OF ELECTRIC SHOCK
DO NOT OPEN**



WARNING : To reduce the risk of electric shock do not remove cover or back. No user-serviceable parts inside refer service to qualified service personnel.

Safety of operators has been taken into consideration at the design and manufacture phase, but inappropriate operation may cause electric shock or fire. To prevent the product from being damaged, the following rules should be observed for the installation, use and maintenance of the product. Read the following safety instruction before starting the operation.

The User Manual uses the following symbols to ensure a safe operation and prevent any damage to operators or properties:



This symbol indicates that high voltage is present inside. It is dangerous to make any kind of contact with any inside part of this product.



This symbol indicates that there are important operating and maintenance instructions in the literature accompanying the appliance.

Important Safety Instructions

Important safeguards for you and your new product

Your product has been manufactured and tested with your safety in mind. However, improper use can result in electrical shock or fire hazards. To avoid defeating the safeguards that have been built into your new product, please read and observe the following safety points when installing and using your new product, and save them for future reference.

1. **Retain these Instructions** ---The safety and operating instructions should be retained for Future reference.
2. **Heed Warnings** ---All warning on the appliance and in the operating instructions should be followed.
3. **Cleaning** --- Unplug from the wall outlet before cleaning. Do not use liquid cleaners or Aerosol cleaners. Use only dry cloth for cleaning.
4. **Attachments** --- Do not use attachments not recommended by the manufacturer as they may cause Hazards.
5. **Water and moisture** -- Do not place this product near water, for example, near a bathtub, wash bowl, kitchen sink, laundry tub, in a wet basement, or near a swimming pool.
6. Do not place this unit on an unstable cart, stand, tripod, bracket, or table. Use only with a cart, stand, tripod, bracket, or table recommend by the manufacture, or sold with the unit.
7. **Ventilation** ---Slots and openings in the cabinets and the back or bottom are provided for Ventilation and to ensure reliable operation of the product and to protect it from overheating, and these openings must not be blocked or covered. The openings should never be blocked by placing the product on a bed, sofa, rug, or other similar surface. This product should not be placed in a built-in installation such as a bookcase or rack unless proper ventilation is provided or the manufacturer's instructions have been adhered to.
8. **Power Source** ---This unit should be operated only from the type of power source indicated on the rating label. If you are not sure of the type of power supply to your home, consult your Appliance dealer or local power company.
9. **Grounding or polarization** ---Do not defeat the safety purpose of the polarized or grounding-type plug. A polarized plug has two blades with one wider than the other. A grounding type plug has two blades and a third grounding prong. The wide blade or the third prong are provided for your safety. If the provided plug does not fit into your outlet, consult an electrician for replacement of the obsolete outlet. To prevent electric shock, ensure the Grounding pin on the AC cord power plug is securely connected.
10. **Power cord protection** ---Power supply cords should be routed so that they are not likely to Be walked on or pinched by items placed upon or against them. Pay particular attention to cords or plugs, convenience receptacle, and the point where they exit from the appliance.
11. **Lighting precaution** ---For added protection for this product during a lighting storm or when it is left unattended for long period of time, unplug it from the wall outlet and disconnect the antenna or cable system. This will prevent damage to the product due to lighting and power line surges.
12. **Accessories**--- Never push objects of any kind into this product through openings as they may touch dangerous voltage point or short out parts that could result in a fire or electric shock. Avoid spilling liquid of any kind on the product.
13. **Servicing** ---Do not attempt to service the product by yourself, as opening or removing covers may expose you to dangerous voltage or other hazards. Refer all servicing to authorized service personnel.
14. **Damage Requiring Service** ---Unplug this unit from the wall outlet and refer servicing to qualified service personnel under the Following conditions:

PORTABLE CARTWARNING
(symbol provided by RETAC)



S3126A

Important Safety Instructions

- a. When the power supply cord or plug is damaged or frayed.
 - b. If liquid has been spilled, or objects have been fallen into the unit.
 - c. If the unit has been exposed to rain or water.
 - d. If the unit does not operate normally by following the operating instructions. Adjust only those controls that are covered by the operating instructions, as improper adjustment of other controls may result in damage and will often require extensive work by a qualified technician to restore the unit to its normal operation.
 - e. If the unit has been dropped or damaged in any way.
 - f. When the unit exhibits a distinct change in performance; this indicates a need for service.
15. **Heat** --- The product should be situated away heat source such as radiators, heat registers, stoves, or other products (Including amplifiers) that product heat.
16. **Overloading** ---Do not overload wall outlets and extension cord as this can result in a risk of Fire or Electric shock.
17. **Outdoor antenna grounding**---If an outside antenna or cable system is connected to the unit, be sure the antenna or cable system is grounded to provide some protection against voltage surges and built-up static charges, Section 810 of the National Electrical Code, ANSI/NFPA 70, provides information with respect to proper grounding of the mast and supporting structure, grounding of the lead-in wire to an antenna discharge unit, size of grounding conductors, location of antenna discharge unit, connection to grounding electrodes, and requirements for the grounding electrode.

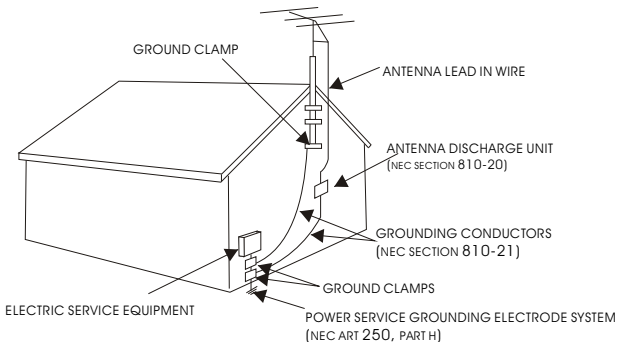

Note: *The PDP Manufacturing Process: a few minute colored dots may be present on the PDP screen*

The PDP (Plasma Display Panel), which is the display device of this product is composed of 0.9 to 2.2 million cells. A few cell defects will normally occur in the PDP manufacturing process. Several tiny, minute colored dots visible on the screen should be acceptable. This also occurs in other PDP manufacturers' products. The tiny dots appearing does not mean that this PDP is defective. Thus a few cell defects are not sufficient cause for the PDP to be exchanged or returned. Our production technology minimizes these cell defects during the manufacture and operation of this product.

Table of Contents

| | | | |
|--|----|--|----|
| Warning..... | 1 | Sound menu..... | 26 |
| Important Safety Instructions..... | 2 | To choose sound modes | 26 |
| Accessories | 4 | Balance..... | 26 |
| buttons and interface location..... | 5 | Setting Five Equalizer sound..... | 27 |
| Front control panel..... | 5 | Setting the surround sound | 27 |
| Rear control panel..... | 6 | Setting the Auto Volume..... | 28 |
| Remote controller..... | 7 | Setting the woofer sound..... | 28 |
| Keys of remote controller..... | 8 | How to eliminate sound | 28 |
| Function introduction | 8 | Timer menu..... | 29 |
| Effective range | 9 | Timer setting | 29 |
| External Equipment Connections..... | 10 | On/off time\Timer on Prog\Timer Prog | 30 |
| Operation | | Function menu..... | 31 |
| Set up your TV..... | 15 | Function setup | 31 |
| Switching ON/OFF the TV set..... | 15 | Adjust menu | 33 |
| Choose the Menu Language..... | 15 | To choose picture aspect ration..... | 33 |
| Select input modes | 16 | H-Position and V-Position adjust..... | 34 |
| Tuning menu..... | 17 | RGB/Default/Auto Sync..... | 35 |
| Auto search..... | 17 | Color Temperature | 35 |
| Program Table | 18 | Black Stretch | 35 |
| Manual search..... | 19 | Lock setup..... | 36 |
| Fine Tuning..... | 20 | Picture in Picture..... | 39 |
| How to select the desired program..... | 21 | Other functions..... | 40 |
| Edit Name..... | 22 | Teletext functions..... | 41 |
| Skip..... | 23 | Maintenance..... | 44 |
| Program swap..... | 23 | Specifications and functions..... | 45 |
| Picture menu..... | 24 | Troubleshooting..... | 46 |
| How to select picture modes..... | 24 | | |
| Noise Reduction | 24 | | |

Accessories



Remote controller



User's manual



Alkaline battery(AA)×2



Power cable

Buttons and interface location

- This is a simplified representation of front panel.
- Here shown may be somewhat different from your TV.

Front control panel

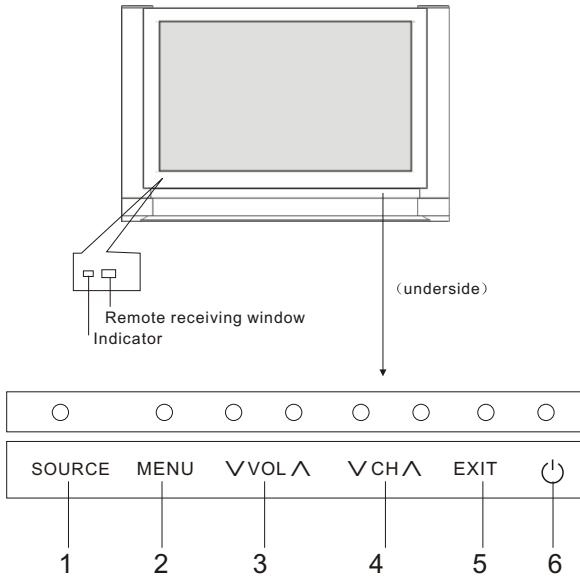

Buttons and functions

- 1、 **SOURCE** button
- 2、 **MENU** button
- 3、 **Volume decrease: for lowering the volume or adjusting MENU.**
Volume increase: for enhancing the volume or adjusting MENU.
- 4、 **Channel number increase and decrease.**
- 5、 **EXIT** button
- 6、 **Power: for turning on or off the power supply.**

Buttons and interface location

Rear Control panel

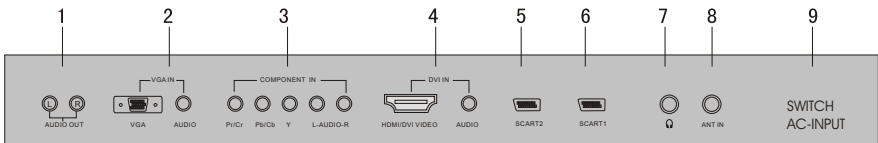

1. **AUDIO OUT:** Connect to optional external speaker(s).
2. **VGA IN(PC)**
Connect VGA analog cable from the PC to the VGAIN. Connect the audio cable from the PC to the VGAAUDIO IN.
3. **COMPONENT IN**
Connect the component cables from the component output of the video device to COMPONENT IN. Connect the audio cable from the video device to the COMPONENT AUDIO IN.
4. **DVI IN (HDMI-IN)**
Connect the HDMI cable from the HDMI output of the digital video device to the HDMI/DVI VIDEO. (If the PC has DVI only, Connect the audio cable from the digital video device to the AUDIO .)
- 5-6. **SCART2/SCART1**
Used to connect to the DVD/VCR/ broadcasting receiver or other equipment.
7. **Earphone port**
8. **ANT IN:** Connect antenna or CATV 75 Ω coaxial cable to receive TV/CATV signal.
9. **SWITCH and AC INPUT:** Power switch and AC power input.

Remote controller

Inserting Batteries

1. Slide open the cover of the battery compartment on the back of the remote controller.

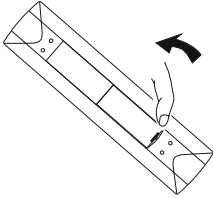

2. Load two AA alkaline batteries in the compartment, paying attention to the polarity diagram in the battery compartment. (plus and minus poles to respective mark)

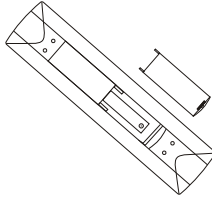

3. Replace the cover of the battery compartment.

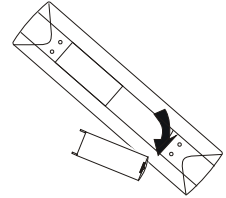

Precautions

As strong light may interfere the signals, change your position to operate the remote controller if the television cannot be turned on or off as you expect.



Make sure that two AA alkaline batteries are loaded. The batteries must be of the same type. The batteries must be located properly. The batteries are not rechargeable.

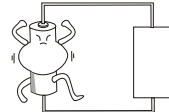

Keep the remote controller away from heat source or humid area to ensure effective performance of the remote controller.

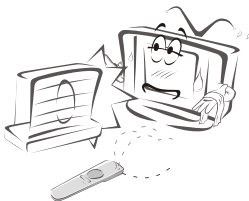

Make sure that there is no obstacle between the remote controller and television set.

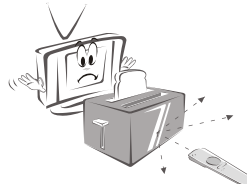

Keys of remote controller

- The remote controller cannot be operated unless the batteries are properly loaded.
- When using the remote control, aim it at the remote control sensor on the TV.

Function introduction

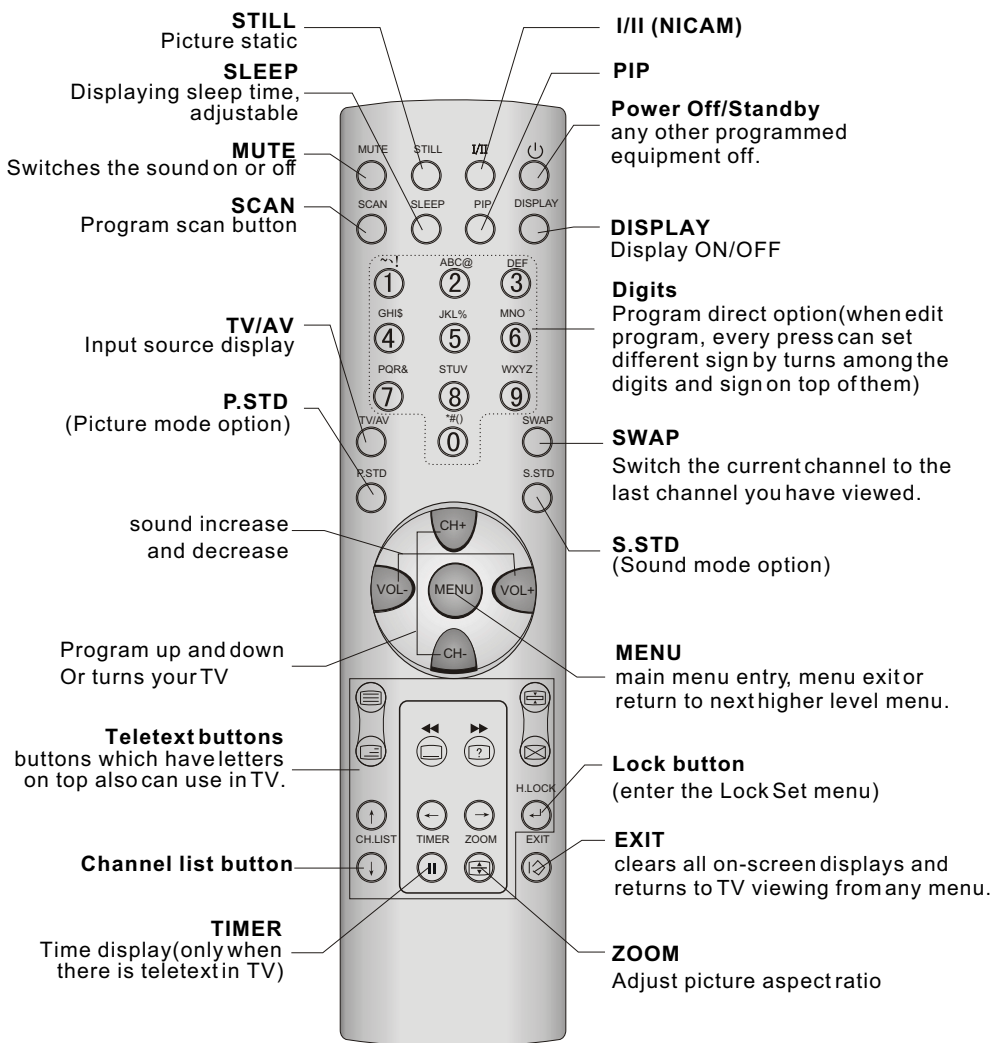

Note:

This User's Manual covers the functions of the remote controller, including CH+/-, VOL-/+ , MENU, TV/AV and POWER keys for control of program up, program down, volume decrease, volume increase, menu, TV/AV and power ON/OFF.

Remote controller

Effective range

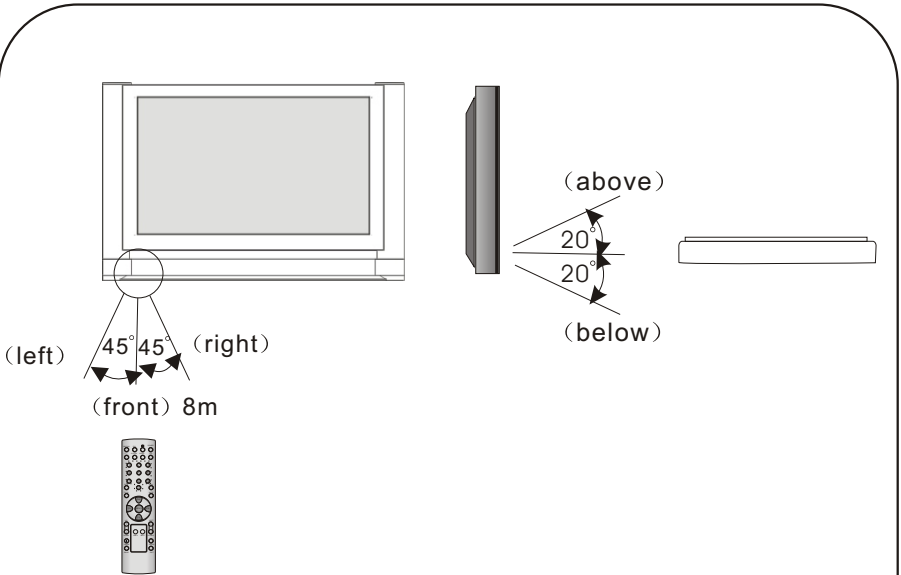

- Ensure the remote controller is pointed toward the remote controller window on the display.
- No obstacles should be placed between the remote controller and the remote controller window.
- The effective receiving scope for the signal is 8 meters to the front of the remote controller window, and 45° to the left or right side and 20° above or below the control window.

Use of remote controller:

1. To ensure a normal operation, the remote controller should not be dropped or damaged in any way .
It should also be kept dry and away from all heat sources.
2. Battery replacement is necessary when the remote controller acts inconsistently or stops operating the plasma display.

External Equipment Connections

Antenna Connection

Generally speaking, to enjoy a clearer picture, we recommend that you use a CATV system or an outdoor antenna. In different places, the suitable antenna type and position are different.

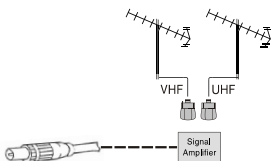
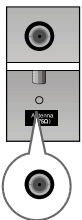
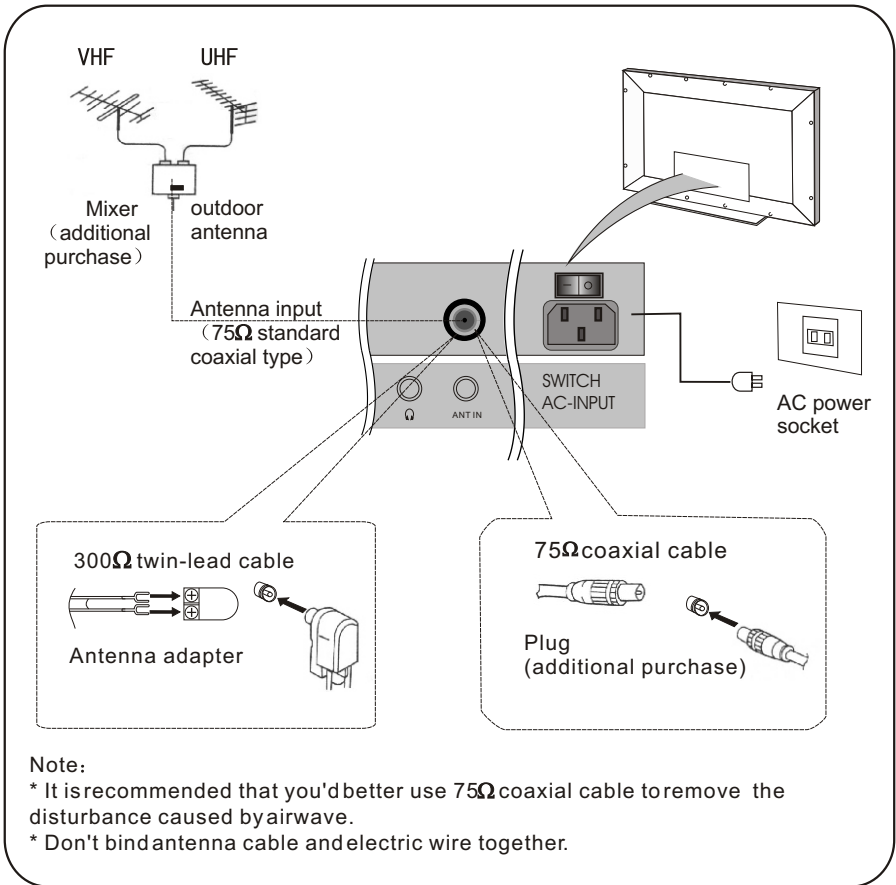

- If the antenna needs to be split for two Tv's, install a "2-Way Signal Splitter" in the connections.
- If the antenna is not installed properly, contact your dealer for assistance.
- To improve picture quality in a poor signal area, purchase and install a signal amplifier.

External Equipment Connection

NOTE: All cables shown are not included with the TV.

Choose Your Connection

There are several ways to connect your television, depending on the components you want to connect and the quality of the signal you want to achieve. The following are examples of some ways to connect your TV.

Choose the connection which is best for you.

VCR connection

- To avoid picture noise (interference), leave an adequate distance between the VCR and TV.

1. Connect the SCART cables from the VCR's output jacks to the TV's input jacks, as shown in the figure.

2. Insert a video tape into the VCR and press PLAY on the VCR. (Refer to the VCR owner's manual.)

3. Select the input source by the TV/AV button on the remote control.

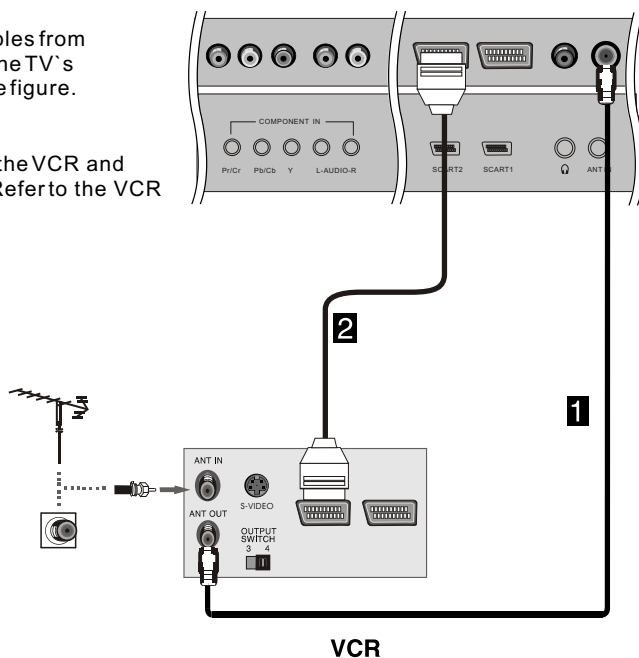

External Equipment Connections

DVD connection

How to connect

1. Connect the DVD video outputs (Y, Pb/Cb, Pr/Cr) to the YUVIN jacks on the TV and connect the DVD audio outputs to the AUDIO IN jacks on the TV, as shown in the figure.
2. If your DVD only has an SCART output jack, connect this to the SCART input on the TV, as shown in the figure.

NOTE: If your DVD player does not have component video output, use S-Video.

How to use

1. Turn on the DVD player, insert a DVD.
2. Use the TV/AV and VOL +/- button on the remote control to select SCART mode.
3. Press Play button on external equipment for program play.
4. Refer to the DVD player's manual for operating instructions.

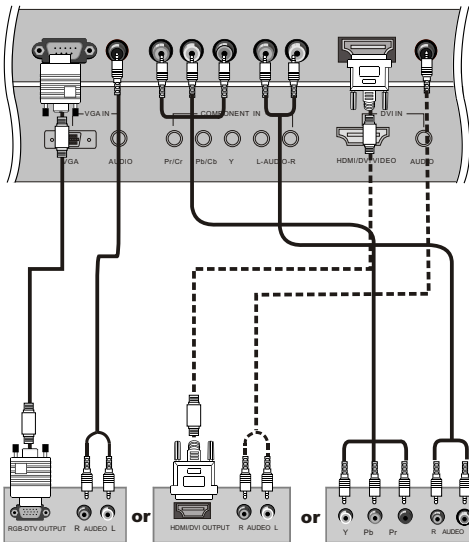
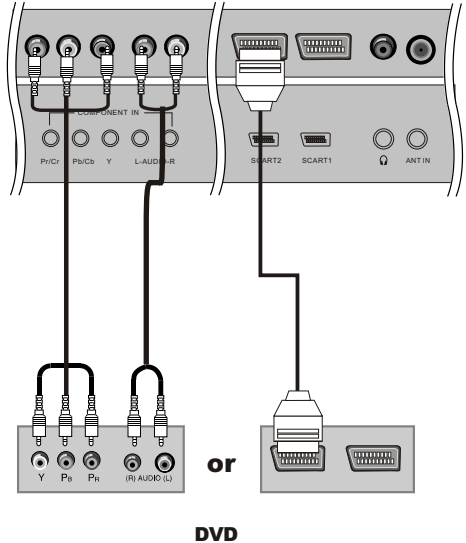

Digital Set-top Box

DTV connection

-To watch digitally broadcast programs, purchase and connect a digital set-top box.

How to connect

Use the TV's YPbPr IN and AUDIO IN jacks, VGA or HDMI/DVI VIDEO port for video connections, depending on your set-top box connections available. Then, make the corresponding audio connections.

How to use

1. Turn on the digital set-top box. (Refer to the owner's manual for the digital set-top box.)
2. Use TV/AV on the remote control to select DVI mode.
3. Press Play button on external equipment for program play.

External Equipment Connections

PC connection

How to connect

1. To get the best picture quality, adjust the PC graphics card to (>1024x768),60Hz.
2. Use the TV's VGA IN port for video connections, depending on your PC connector.
 - If the graphic card on the PC does not output analog and digital RGB simultaneously, connect only one of either VGA IN to display the PC on the TV.
 - If the graphic card on the PC does output analog and digital RGB simultaneously, set the TV to either VGA; (the other mode is set to Plug and Play automatically by the TV.)
3. Then, make the corresponding audio connection. If using a sound card, adjust the PC sound as required.

How to use

1. Turn on the PC and the TV.
2. Turn on the display by pressing the POWER button on the TV's remote control.
3. Use TV/AV on the remote control to select PC.

or DVI source.

4. Check the image on your TV. There may be noise associated with the resolution, vertical pattern, contrast or brightness in PC mode. If noise is present, change the PC mode to another resolution, change the refresh rate to another rate or adjust the brightness and contrast on the menu until the picture is clear. If the refresh rate of the PC graphic card cannot be changed, change the PC graphic card or consult the manufacturer of the PC graphic card.

NOTES:

- 1 Use a VGAcable.
- 2 Avoid keeping a fixed image on the TV's screen for a long period of time. The fixed image may become permanently imprinted on the screen.
- 3 The synchronization input form for Horizontal and Vertical frequencies is separate.

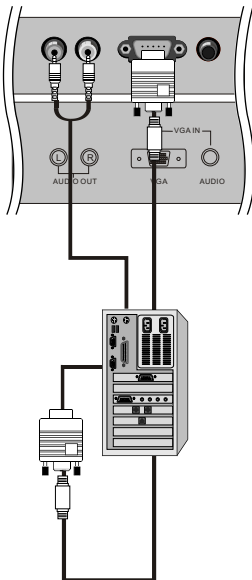

Resolution

| Mode | Resolution | Line frequency (Khz) | Frame frequency (Hz) |
|------|------------|----------------------|----------------------|
| VGA | 640*480 | 31.5KHz | 60Hz |
| SVGA | 800*600 | 37.9KHz | 60Hz |
| XGA | 1024*768 | 48.4KHz | 60Hz |

External Equipment Connections

Connecting Headphones

You can connect a set of headphones to your set if you wish to watch a TV programme without disturbing the other people in the room.

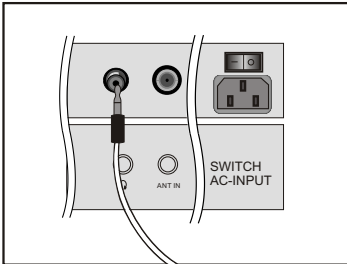

Plug a set of headphones into the 3.5mm mini-jack socket on the rear panel of the set.

Note:

- Prolonged use of headphones at a high volume may damage your hearing.
- You will not receive sound from the speakers when you connect headphones to the system.



Power source

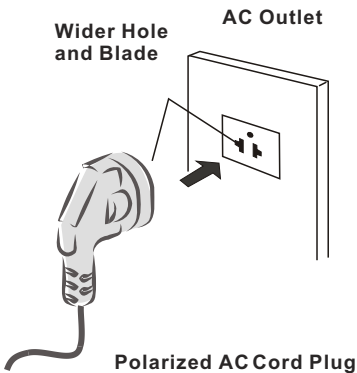

TO USE AC POWER SOURCE

Use the AC polarized line cord provided for operation on AC. Insert the AC cord plug into a standard polarized AC outlet.

NOTES:



- Never connect the AC line cord plug to other than the specified voltage. Use the attached power cord only.
- If the polarized AC cord does not fit into a non-polarized AC outlet, do not attempt to file or cut the blade. It is the user's responsibility to have an electrician replace the obsolete outlet.
- If you cause a static discharge when touching the unit and the unit fails to function, simply unplug the unit from the AC outlet and plug it back in. The unit should return to normal operation.

Set up your TV

- There are several options you might need to set up in order for your TV to work properly. Read the instructions that follow.
- In the manual, the OSD (on screen display) may be different from your TV's, because it is just an example to help you with the TV operation.



Switching ON/OFF the TV set

- 1 Please press down the power switch to switch on AC power supply and the power indicator will light.
- 2 If the indicator is lighting in red, press  button on the remote controller again.
- 3 If you want to exchange to standing by status, please press down button  on the remote controller.
- 4 Disconnect the power supply or unplug the television if it is intended to completely cease the television performance.

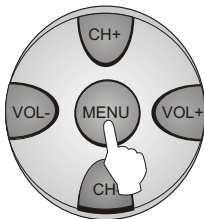

Choose the Menu Language

When you start using your set for the first time, you must select the language which will be used for displaying menus and indications.

- 1 Press the **MENU** and **CH+/-**-button to select the **Function** menu.
- 2 Press **VOL+** to enter.
- 3 Press **CH+/-**-button to select **Language**.
- 4 Select a particular language by pressing **VOL+/-** button repeatedly. You can choose one of 13 languages.
- 5 When you are satisfied with your choice, press **MENU** button to return to previous or press **EXIT** button to return to TV viewing.

Select input modes



Choose the input source

If you hope to enjoy the picture from the external input source, before to select the source, you need to connect the devices, otherwise, when you select the source, the none or no signal will appears on the screen.

Press **INPUT** or **TV/AV** button on television or remote controller, the menu appears on the screen. Then press **CH+/-** to select the TV item, and press **VOL+** to ensure it.

| Source |
|------------|
| TV |
| SCART1 |
| SCART2 |
| HDTV |
| PC |
| HDMI / DVI |

- TV:** the input source from ANT IN terminal output.
- SCART1:** the input source from SCART1 terminal output.
- SCART2:** the input source from SCART2 terminal output.
- HDTV:** the input source from YPbPr terminal output.
- PC:** the input source from VGA IN terminal output.
- HDMI/DVI:** the input source from DVI IN terminal output.

Before watching TV program, you need to ensure your TV in TV mode.

Memory function

When menu parameter is to be modified, the set picture and sound status and preset program will be remembers as menu exit.

Tuning menu

- This TV set has three methods to set channels, which are respectively full automatic, manual search, fine tune.
- In this section, how to use the remote control to set channel is explained. You can also use buttons on the TV set to set channel.

Full automatic search mode



Note:

If you have set TunerLock in Lock Set menu. Password must be entered when operating menu tuning. Otherwise there will be Tuner Lock display on screen.

Automatic search

- 1 Press MENU button and then CH+/- button, the icon to TUNING menu.
- 2 Press the VOL+/- buttons to enter submenu, and press CH+/- button to select "country" first according to yourself that means you have selected the sound system, this is useful especially for France), and then press CH+/- button to select "Auto Search" item.

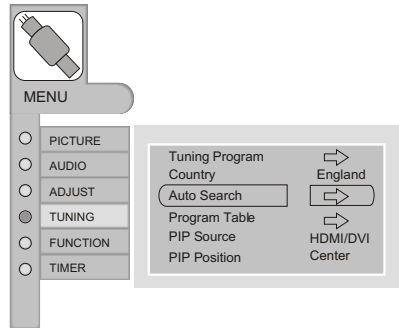

Note : the TUNING menu will be only operated in normal TV mode.

- 3 Press the VOL+/- button to ensure automatic search with higher level.

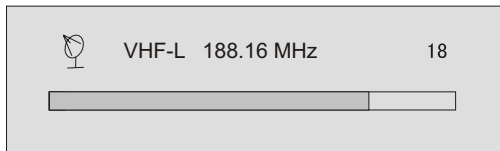

After the search has finished, all channels now playing program will be automatically preset in order.

Tuning menu



Program Table

1 Press MENU button and then CH+/- button, the icon to TUNING menu.

2 Press VOL+/- button to enter submenu, and press CH+/- button to select "Program Table", press VOL+ button to enter. Or press CH.LIST button on remote controller.

3 Press CH+/- button to select the edited channel, and press button corresponding to edit.
(Red button: delete channel;
Green button: copy channel;
Yellow button: Name channel;
Blue button: Swap)

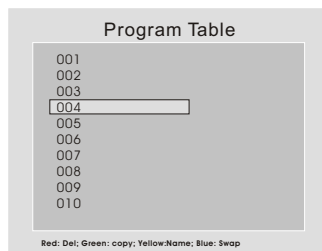
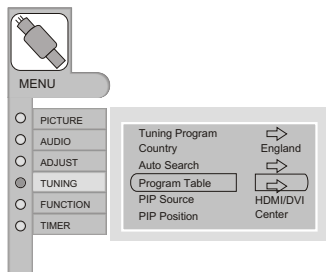

delete name

Press CH+/- to select the channel, and press the red button on the remote controller to delete, then press **MENU** button to delete name.

Copy channel

Press CH+/- to select the channel, and press the green button on the remote controller, then press CH+/- button to select the channel to copy, press again the green button then press **MENU** button to ensure.

Name channel

Press CH+/- to select the channel, and press the yellow button on the remote controller, and press the yellow button to display the digital and letter list, press Vol+/- or CH+/- to select the desired digital or letter, press the yellow button to exit list, then press **MENU** button to ensure.

Swap channel

Press CH+/- to select the channel, and press the blue button on the remote controller, then press CH+/- button to select the channel to swap, then press again the **blue** button to ensure.

Tuning menu



Manual search

If excessive channel signals of unwanted programs are received in local area, manual search function is recommended.

1 Press CH+/- buttons or the NUMBER (0-9) button to choose desired searching frequency.
(regard channel 18 as example).

2 After calling up the **TUNING** menu, press CH+/- button to select **"Tuning Program"** item.

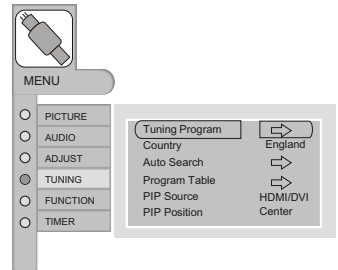

3 Press CH+/- to select Manual Search item, Press VOL+ button to enter the desired frequency and press the digital button to adjust.

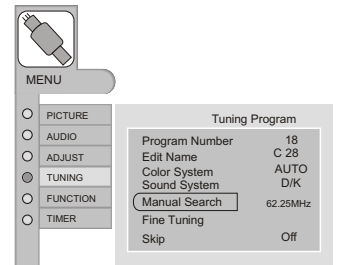

4 press **MENU** button to return to previous or press **EXIT** button to return to TV viewing.

Tuning menu



Fine Tuning

If the picture and/or sound are poor, try using the FINE TUNING feature. Do not use this feature unless reception is poor.

1 Press CH+/- button or NUMBER (0-9) button to choose desired channels

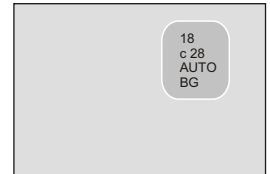

2 Press MENU button and CH+/- button, till the TUNING menu shown on the right display on the screen.

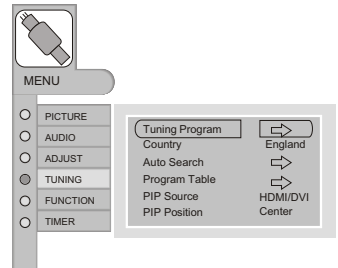

3 Press VOL+ button to enter submenu, and press CH+/-button to select Tuning Program item, and then press VOL+ to next submenu, and press CH+/-button again to make the icon to **Fine Tuning**.

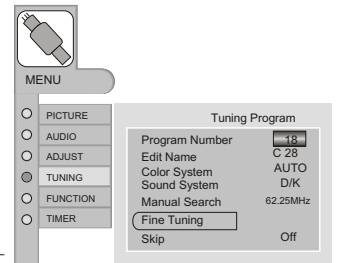

4 Press VOL-/+ button all through to carry out fine tune, till the best picture and sound are obtained, then loosen the button.

Tuning menu

You can watch TV program in a presetting channel.



How to select the desired program

1 Using "Program number" buttons

Press digit button to select the program.

If 2-digit or 3-digit programs are selected, press digit buttons you needed continuously within 3 seconds.

If selected channel program is set at Lock on mode and no password has been entered after initiation of the television, the screen will indicate require password entry. If wrong password is entered, channel selection will fail and previous program will still stay on the screen. The program locking password can be modified in the preset menu and previous password will be required.

2 Using the CH+/- button.

- Press the CH+ button to select a channel number in number increasing direction.

- Press the CH- button to select a channel number in number decreasing direction.

(Note: If Skip is ON on one channel, press CH+/- button, the channel will not appear.)

How to select the desired sound

Press the VOL-/+ button on the remote controller or the front of the TV set to adjust the volume level.

The range is 0~100. When the volume buttons are pressed the volume level is displayed automatically on the TV screen.

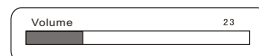

Tuning menu

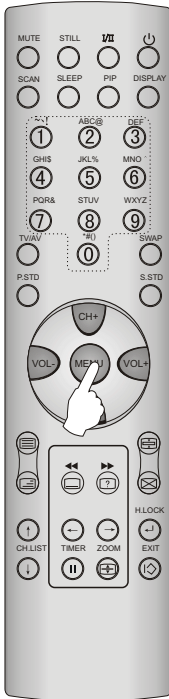

If the colour of some channel is abnormal

Usually this should be set in the auto position. However if the colour displayed on the screen are incorrect, you can manually select the correct colour system.

Press the MENU, CH+/- and VOL+/- button, till the Tuning Program menu shown on the right will display on the screen.

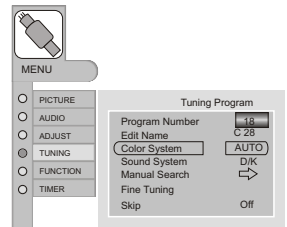

If picture color is abnormal

Press the CH+/- button to select "Color System", then press the VOL-/+ button to select the correct color system. In general, you can set it as "AUTO". Press VOL+/- button to select **AUTO**, **NTSC**, **PAL**, **SECAM**, **PAL60** and **NTSC4.43** in turn.

If sound is abnormal

Press the CH+/- button to select "Sound System", then press the VOL-/+ button to select the correct sound system. Press VOL+/- button to select **D/K**, **I**, **B/G**, **M** in turn.

Edit Name

If current program is to be named, press **VOL-/+** button to select position you want to change and press digits to change, press **MENU** button to ensure it.

Tuning menu

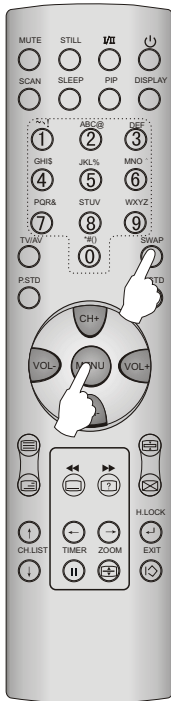

Skip

After the programs are presetting, you can skip some programs so that to select your favorite channels only.

1. Press CH+/- button or Direct-digit Choosing button to select a channel directly (take channel 18 for example).

2. Press MENU, CH+/- and VOL+/- button, till the **Tuning Program** menu shown on the right will display on the screen.

3. press VOL+/- button to set **Skip On**. And press menu exit.

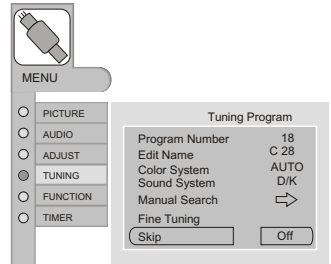

If you want to recover the skipped channel

1. Use Direct-digit Choosing button to select the number of the channel to be recovered.
2. Do the above steps again.
3. Press VOL+/- button to set **Skip Off**.

Program swap

Swap function enables quick swap to the last watched program.

1 Suppose the channel number you used just now is 8 and the channel number you are using is 18 (as shown in the figure).

2 If you want to return to the last watched program channel 8, you can simply press the swap button.

3 If you want to return to channel 18, press the button again. Through this function, you can easily change between the channel you are using and the channel you used last time.

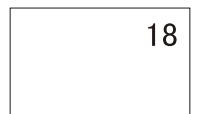
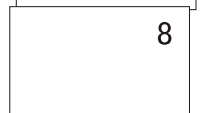
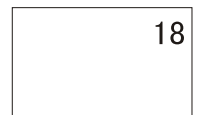

Picture menu



How to select picture modes

You can quickly select the desired picture mode from three preset modes and one customized mode.

Press the P.STD button to call up Video mode menu, and press CH+/-button to select the desired picture quality. Four kinds of picture modes (i.e., "Normal", "Soft", "Personal", "Bright",) can be selected in turn.

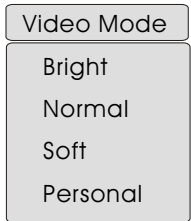

- Personal A spare setting that can be adjusted to personal status
- Normal Designed for rooms that have good all round lighting
- Soft Designed for nighttime low light viewing
- Bright Designed for rooms with high ambient lighting such as daytime sport;

How to customize your own picture status

1 Press MEUN button and then CH+/- button , till the **PICTURE** menu shown on the right display on the screen. Press VOL+/- to enter.

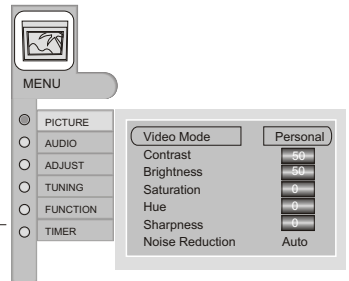

2 Press the CH+/- button to select the item to adjusted, then press the VOL+/- buttons to obtain the desired effect.

Note: 1. the hue item is available only in NTSC system.
 2. the **video mode**, the **saturation**, the **hue** and the **sharpness** items are no available in VGA and DVI mode.

| | Press VOL- | Press VOL+ |
|-------------------------|---------------|------------|
| Brightness | Dark | Bright |
| Contrast | Weak | Strong |
| Sharpness | Soft | Sharp |
| Saturation | Shallow color | Deep color |
| Hue (only in NTSC mode) | More purple | More green |

NOTE : these items are adjustable only when the "video mode" is set as "personal".

Picture menu



Noise Reduction

Automatically filters out and reduces the image noise and improves picture quality when receiving weak video signals.

1 After calling up the Picture menu, press CH+/- button to select "Noise Reduction" item.

2 Press VOL+ to enter the list. Select **Off, Auto Weak, Medium or Strong** according to the image noise.

3 Press MENU return to the picture menu.

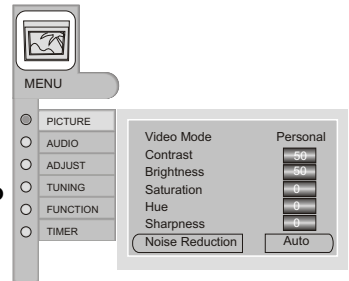

Sound menu



To choose sound modes

You can quickly select the desired sound mode from three preset modes and one customized mode.

Press the S.STD button to call up Audio mode menu, and press CH+/- button to select the desired sound quality. Four kinds of sound models (i.e., “Music”, “Personal”, “Standard” and “Hall”) can be selected in turn.

Audio Mode

Music
Standard
Hall
Personal

| Sound mode | Sound quality |
|------------|---|
| Personal | A spare setting that can be adjusted to personal tastes |
| Standard | Normal sound with moderate bass and treble setting |
| Hall | Designed to reduce the bass and treble which enhances the voice for news programs |
| Music | Enables extra bass and treble to enhance the movie experience |

Balance

To balance right and left sound of the television.

The intermediate value is 0. When indication value of Balance increases toward +50, sound of the right and left speaker becomes stronger and weaker, respectively. When indication value of Balance decreases toward -50, sound of the right and left speaker becomes weaker and stronger.

1 Press MENU button and then CH+/- button to select AUDIO menu.

2 Press VOL+ to enter the submenu. Press CH+/- button to select **Balance** item. Press VOL+/- to adjust the desired level.

3 Press MENU return to the picture menu.

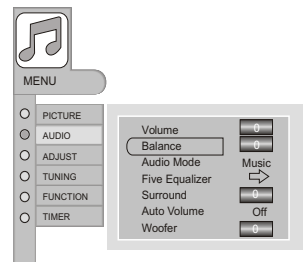

Sound menu



Setting Five Equalizer sound

The sound settings can be adjusted to suit your personal preferences.

1 Press MENU button and then CH+/- button to select AUDIO menu.

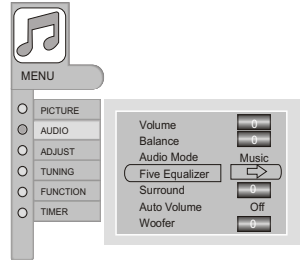

2 Press CH+/- button to select "Five Equalizer", then press VOL+ buttons to enter the submenu.

3 Press CH+/- button to select frequency to adjust, then press VOL+/- buttons to adjust the value data.

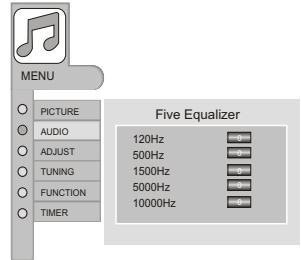

4 When you are satisfied with the setting, press MENU button to return to the previous menu.

Setting the surround sound

The surround sound feature expands the audio listening field wider and deeper to create exceptional sound quality from the TV's speakers.

Select **Surround** from -50 to +50 . When intermediate value toward +50, the effect will be distinctness.

Repeated step 1-2, and press CH+/- to select **surround**, and then press VOL+/- to set the desired value.

Sound menu



Setting the Auto Volume

Each broadcasting station has its own signal conditions, and so it is not easy for you to adjust the volume every time the channel is changed. This feature lets you automatically adjust the volume of the desired channel and reduces the volume differences between channels and programs, providing a more constant overall level. This will also reduce the dynamics of sound.

Repeated step 1-2, and press CH+/- to select **Auto Volume**, and then press VOL+/- to set as Off or On.

Setting the woofer sound

Woofer is a speaker that complements front speaker's reproduction capability of low-pitched sound. Select **Woofer** to set the value of woofer from 0 to 100.

Repeated step 1-2, and press CH+/- to select **Woofer**, and then press VOL+/- to adjust the desired level.

How to eliminate sound

When you need to pay attention to surrounded sounds, or there is a telephone calling you or there are some guests visiting you, the sound elimination (mute) function is very convenient.

1 Press the MUTE button on the remote control and "Mute" type face will display on the lower part of the screen. At this time, the sound of the TV set is turned off.

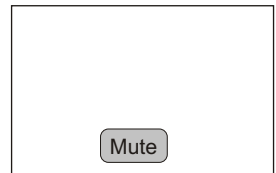

2 If you want to recover the sound, press the MUTE button again or directly press the VOL-/+ buttons.

Timer menu



NOTE:

1. If Timer option is setting, the time you set for Time Off/Time On will be a point of time. Otherwise, if Timer is not set, the time you set for Time Off/Time On will be a period of time.

2. Sleep Off/Time Off can not be set at simultaneously. If both of the two are set, the later setup will be operation.

Timer setting

The clock will only work if the TV set is turned on or in standby. When the set is disconnect from the power supply or is turned off by the main power on the rear panel, the clock loses power and will need to be reset when the power

1 Press the MENU button and CH+/- button, till the TIMER menu display on the screen.

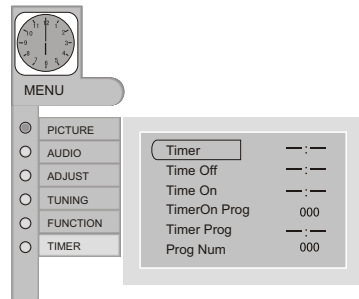

2 Press CH+/- button select "Timer", press VOL -/+ buttons to select hour or minute position; then press digits buttons to set the value of hour or minute;

3 Press MENU button to return the previous menu.

Indication will appear on the screen 1 minute prior to expiry of set time.

Suppose Time Off is set, and indication is as follows:

Time Off

Timer menu

You can set the On/Off timers so that the set will :

- Switch on automatically and tune to the channel of your choice at the time you select.
- Switch off automatically at the time you select.



On/off timer \Timer on Prog\ Timer Prog

1 Press MENU and VOL+/- button to call up the **TIMER** menu on the screen.

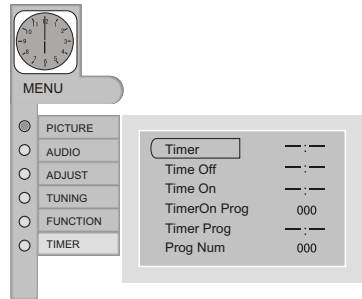

2 Press CH+/- button to select **"Time On"**, press VOL+/- buttons to select hour or minute position; then press digits buttons to set the value of hours or minutes. (take 19:00 as an example)

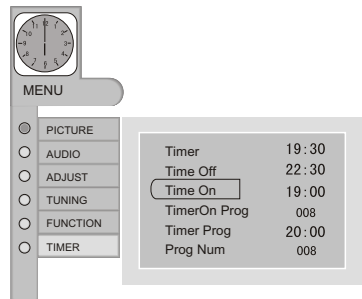

3 Press CH+/- button to select **"Timer On Prog"**, then press VOL+/- and program direct number buttons to select your desired channel (take 8 as an example).

4 press CH+/- button to select **"Timer Prog"**, press VOL+/- buttons to select hour or minute position; then press digits buttons to set the value of hours or minutes.

5 Repeat step 1-2 to set **"Time Off"** .(Take 22:30 as an example)

Function menu

It is possible to select language, OSD transparent, position and screen display of the menus as follows:



Function setup

1. Press MENU button once, and the CH+/- button until the following menu appears on the screen:

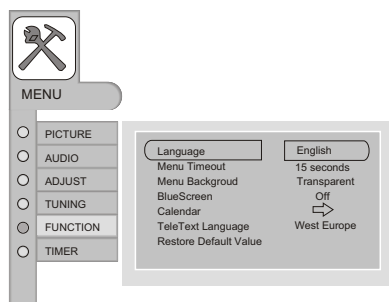

2. Press VOL+ button on the remote controller to call up the FUNCTION menu.

3. Press CH+/- to select desired item on the menu.

4. Press VOL+/- to adjust the item you have selected.

OSD language option

Repeat step 3 and 4 to select the language you wanted from the 13 kinds of languages.

Menu Timeout

Repeat step 3 and 4 to select the time of the OSD display in sequence as follows: 5 seconds, 15 seconds, 10seconds, 20seconds, 25seconds, 30 seconds and 40 seconds.

Menu Background

Repeat step 3 and 4 to select Transparent/ Opaque background of OSD.

Blue Screen

Repeat step 3 and 4 to select Blue Screen On/Off. If you select ON, when no signal, the background is blue; if you select OFF, when no signal, the background is dark.

Function menu



Function setup (continue)

Calendar display and check

Repeat step 3 and 4 to enter Calendar menu as follows:

| 2005-01-01 | | | | | | |
|------------|------|------|------|------|------|------|
| Sun. | Mon. | Tue. | Wed. | Thu. | Fri. | Sat. |
| | | | | | | 1 |
| 2 | 3 | 4 | 5 | 6 | 7 | 8 |
| 9 | 10 | 11 | 12 | 13 | 14 | 15 |
| 16 | 17 | 18 | 19 | 20 | 21 | 22 |
| 23 | 24 | 25 | 26 | 27 | 28 | 29 |
| 30 | 31 | | | | | |

Press VOL+/- to select among year, month and day, and then CH+/- to adjust them.

Teletext Language

Repeat step 3 and 4 to select from 6 kinds of languages. (West Europe/East Europe/Cyrillic/Greek/Arabic/Persian.)

Restore Default Value

Repeat step 3 and 4 to return the factory mode.

Adjust menu



Note: Under the HDTV, VGA and DVI signal, there are only Normal and 4:3 mode to adjust.

To choose picture aspect ratio

1 Using “ZOOM” button.

Press **ZOOM** button to select the desired picture ratio. Three kinds of aspect ratio models (i.e., "Normal", "Wide screen" and "4:3 mode") can be selected in turn.

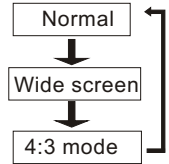

| Aspect ratio | Picture effect |
|--------------|--|
| Normal | no cut out on input signal, picture with un-changed scale displayed on the screen(to keep the scale, maybe only the center area of the screen is active) |
| Widescreen | input signal is vertically cut out by 10% and picture's center area is non-linear zoomed to fill the whole screen |
| 4:3 mode | Choose 4:3 when you want to view a picture with an original 4:3 aspect ratio, with blackbars appearing at both the left and right sides. |

2 Using the MENU button.

1 Press MENU button and then CH+/- button, till the ADJUST menu shown on the right display on the screen.

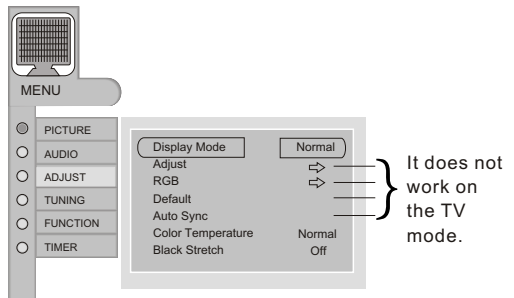

2 Press CH+/- button to select “Display Mode” option, then press VOL+ button to select the desired option.

Adjust menu

In PC and HDMI/DVI input mode, H-Position and V-Position can be adjusted to eliminate transverse line interference and decentered picture as follows:

H-Position and V-Position adjust

Adjust is opted for adjusting H-Position and V-Position as well as relative parameters in VGA and DVI modes.

1. Press MENU button and CH+/- to call up the ADJUST menu. as follows:

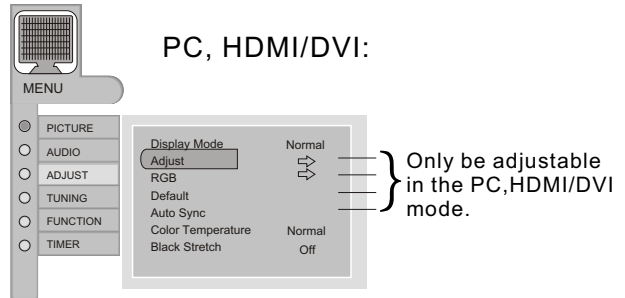

2. Press VOL+ button on television or remote controller to enter the adjust menu of picture position setup.

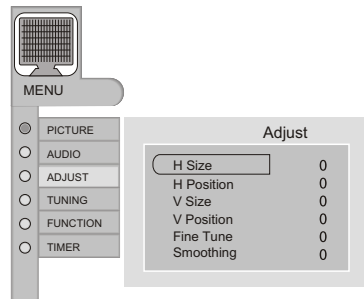

3. Press CH+/- button for desired adjust parameter option.

4. Press VOL+/- for desired adjust parameter option until satisfactory value is achieved. When VGA signals are received, the automatic mode is used for parameter adjustment.

H Size: Horizontal size of picture can be adjusted in this item.

H Position: Horizontal position of picture can be adjusted in this item.

V Size: Vertical size of picture can be adjusted in this item.

V Position: Vertical position of picture can be adjusted in this item.

Fine Tune: Adjust phase to the best effect suiting for VGA signal.

Smoothing: make the line of the picture smooth.

Adjust menu



RGB/Default/Auto Sync

- 1) RGB is opted for adjustment of the numerical value of red, green and blue in PC,HDMI/DVI mode.
- 2) Default is opted for adjustment of parameters to delivery setup in PC mode.(After the operation, complete will be on the right of the operation)
- 3) Auto Sync is opted for adjustment of picture location frequency and phase parameters in PC mode.(After the operation, complete will be on the right of the operation)

Color Temperature

Press CH+/- to make the icon to Color Temperature, and press VOL+/- button to select.

There are four kinds of modes (i.e., "Normal", "Cold", "Green", "Warm") can be selected in turn.

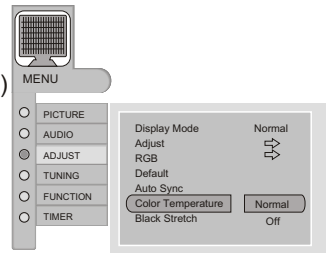

This will increase or decrease **Warm** (red) and **Cold** (blue) colors to suit personal preferences. Select **Cold** to give the white colors a blue tint, **Normal** to give the white colors a neutral tint, **Warm** to give the white colors a red tint. **Green** to give the white colors a green tint.

Black Stretch

Black Stretch-(Automatically Increases the Contrast Range)

Lock setup

The television has the function of security default lock. Password needs to be entered when the program lock mode is to be set.



Note:
If Clear Lock is activated, the password setup cannot be changed.

How to use the password function

Press H.LOCK button, Password will appear on the screen.



The initial password of the television is 0000 and security default password is 9443. then enter Lock Set menu.(as follow)

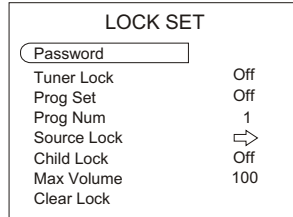

The television has the function of security default lock. Password needs to be entered when the program lock mode is to be set.

Note: If the password is not correctly entered, you will be required to reenter the password and the cursor will stay at the first place.

The security default password is 9443.
Press EXIT to cancel the window.

To set new Password

The password can be changed.

After entering the Lock set menu, Press CH+/- to select **password**, Press vol+/-, the screen will display the follow.

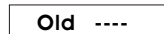

If correct password is entered, the screen will display the follow.

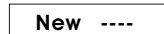

Press digital button to set the new desired password, and the screen will display the follow.



If the desired password is entered correctly twice, the old password will be changed. If the desired password is not correctly entered twice, the screen will display New ----, then you have to reenter the password.

Lock setup



Tuner Lock

Press **CH+/-** to select Tuner Lock and **VOL+/-** to set On/Off. (To set On, some operation such as search will be not available. When enter the TUNING menu, Tuner Lock will be on the screen, and the time will be the same with the main menu if no operation. If you want to operate TUNING menu, you need to enter the Lock menu to set Tuner Lock Off or operate Clear Lock.

Prog Set

Prog Set is opted for setting up start channel. Press **CH+/-** button to select Prog Set. Press **VOL+/-** button, sources can be swapped in TV/SCART1/SCART2/HDTV/PC/HDMI/DVI mode. After setup, the set mode will be entered if the television is switched off and on again. To set Off, the television will memory the off-channel.

Prog Num

Prog Num is opted for setting up preset channel. Press **CH+/-** button to select Prog Num. Press **VOL+/-** button, to select channel number. (The item is not available except TV signal.)

Source Lock

Source Lock is opted to hinder external input modes, such as AV, Scart and VGA. Press **CH+/-** button to select the option, and press **VOL+/-** button to display Source Lock menu as follows:

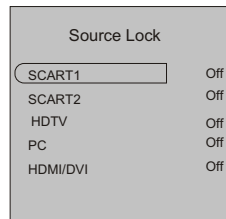

Press **CH+/-** button to select desired option. Press **VOL+/-** button to set up the mode of Source Lock. If some Source Lock is set **ON**, the mode will be entered and the screen will display blue background with the mute mode activated and Lock. In lock on mode, when screen is blank, icon Lock will be always displayed on the screen. If lock mode is to be verified, enter Source Lock submenu and set relative mode off, or select Clear Lock in the Lock Set Menu.

Lock setup



Child Lock

Press **CH+/-** button to select Child Lock. Press **VOL+/-** button to set **On** or **Off** mode. If lock on mode is set, Child Lock is in activated automatically. In such case, if Child Lock button (button on the television) is pressed, the screen will display **Child Lock**, which can be erased by press of **EXIT** button. 5 seconds later after the latest press, the screen display will disappear automatically. The Child Lock mode can be resumed by entering Lock Set menu, set Child Lock **On** or **Off**.

Max Volume

Press **CH+/-** button to select Max Volume. Press **VOL+/-** button for adjustment between 0~100. If a certain value is set, when volume is being adjusted, the sound value can not exceed maximum volume value. If current volume is over Max Volume, when Lock Set menu is set, current volume will become set maximum volume. If current volume is below maximum volume, customer set volume will stay unchanged.

Clear Lock

Press **CH+/-** button to select Unlock mode. Press **VOL+/-** button to unlock all set modes, setting all lock options to off, and the maximum volume returns to 100.

Picture in Picture



NOTE:

- If to use PIP function, you need to select one of two in main picture source and available sub picture source;
- When the VGA is be sub picture, the resolution must be more 800x600 dot;
- When the HDMI/DVI is be sub picture, the DVI to HDMI is no useful.

Preparation

Press the PIP button on the remote control to switch to PIP function.

PIP position

1 Press MENU button and then press CH+/- button, till the TUNING menu shown on the right display on the screen.

2 Press the CH+/- button to select **PIP Position** item.

3 Press the VOL+ button repeatedly until desired position is achieved. The sub picture moves Left Top/Right Top / Right Bottom/ Left Bottom /Center.

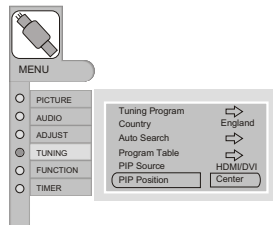

Selecting an Input Signal Source for PIP

1 Press MENU button and then press CH+/- button, till the TUNING menu shown on the right display on the screen.

2 Press the CH+/- button to select **PIP Source** item.

3 Press the VOL+ button repeatedly until desired source is achieved.

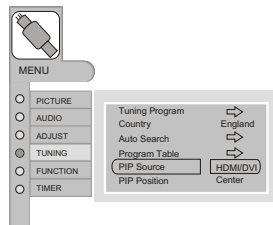

Each press of VOL+/- button changes the main source.

| Main Picture Sources | Available SubPicture Sources |
|-----------------------------|------------------------------|
| TV, SCART1, SCART2, HDTV,PC | HDMI/DVI |
| TV,HDTV,PC | HDMI/DVI/SCART(RGB) |
| SCART(RGB) | TV,HDTV,PC |
| HDMI/DVI | TV, SCART1, SCART2, HDTV,PC |

Others functions



NICAM

If the broadcaster is transmitting Bilingual sound service. The I / II button on the remote controller will allow up to 2 separate languages to be selected. You can press the I / II button to make a choice.

Display function

If current program number, color system and sound system are to be displayed on the screen, press **DISPLAY** button, and all the related information will appear at right up corner of the screen.

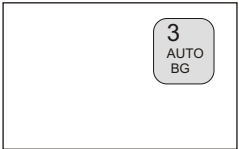

If the **DISPLAY** button is pressed again, the displayed information will disappear. (If the program is named, its name will also appear).

Auto program scan

1 If you want to select a desirable program, you may scan all the TV programs in memory. You can simply press **SCAN** button to do this. Press scan button once, there are nice pictures on the screen. Press scan button again, there are sixteen pictures on the screen.

| | | |
|---|---|---|
| 1 | 2 | 3 |
| 4 | 5 | 6 |
| 7 | 8 | 9 |

2 If you want to stop the function during auto tuning, simply press **SCAN** button again.

Others functions

Note:

The ON TIME setup and the SLEEP setup is absolute one another.

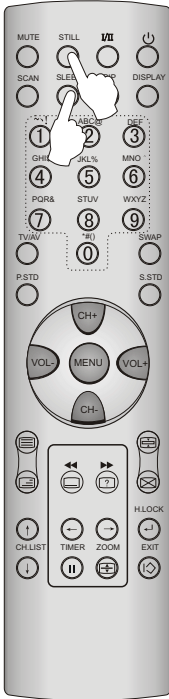

Sleep

The TV set will switch automatically to standby at the preset time with the SLEEP time on. You may set the sleep time, Operate as follows:

1. Press SLEEP button repeatedly to select the number of preset minutes, the timer will be set in sequence:
0Min → 15Min → 30Min → 60Min → 120Min → 240Min → 0Min

2. After the sleep time is set, the Indication will appear on the screen 1minute prior to expiry of set time.

Time off

3. If remaining time of set timer is to be displayed, press **SLEEP** button again. The TV set will switch off automatically at the preset time, press CH+/- button to turn on again.

4. If to cancel sleep time, press **SLEEP** button repeatedly to set as 0.

Picture Still

Press **Still** button, the picture will be still; if to cancel, press Still button again, the picture will resume.

Auto switch-off function

If an empty channel is selected or the TV programs are ended for the day, the power will be switched off 5 minutes later automatically. If the "OFF TIME" is setting, it will be switched off according to the presetting time. The auto power off function does not work under video input.

Under PC state, if no signals input, the television will enter standby status 1 minutes later automatically.

Teletext functions

Teletext is an information system, broadcast by certain channels, which can be read like a newspaper . It also provides subtitles for people with hearing difficulties or those who are unfamiliar with the language in which a particular programme is being broadcast (cable networks, satellite channels, etc.).

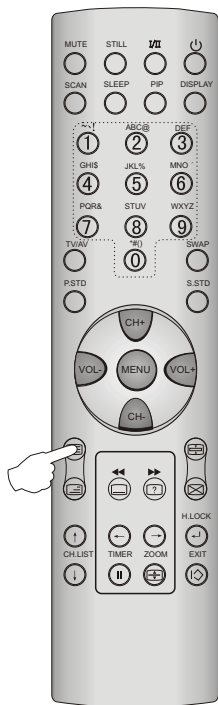

Teletext function operation

You can press  button into TEXT mode, press again to leave TEXT mode. All menu related functions are not available in TEXT mode. Only a few direct button control functions are available in TEXT mode, they

1 Page up/down

Result: Use the CH+/- buttons to browse next or previous page.

2 Page number entering

Result: To select a teletext page either directly enter the page number using the numeric button pad on the remote control or use CH+/- buttons, or the colored Fast Text buttons.

Teletext functions

(MIX)

While in Teletext mode press the  button will show the teletext data superimposed on top of the TV picture. Press the button again to revert back to Full text.

(HOLD)

Pressing the  button will stop the teletext page automatically updating. This feature is very useful where there are several teletext pages or data on the same page number.

(SIZE)

Pressing the  button to change from different screen display size. This feature is very useful as it magnifies the image making the characters easier to read.

(REVEAL)

Pressing the  button will reveal hidden text. This feature is used to reveal information such as answers to Teletext on-line interactive puzzles.

TIMER

While in normal TV mode only, pressing the button **TIMER** will display the teletext time in the top right corner for a few seconds.

(TEXT)

Press the  button on the remote control to turn teletext On/Off.

(SUBTITLE)

Pressing the  button will get the teletext decoder to automatically search for the subtitle page. In NZ the subtitle is usually page 801.

(INDEX)

Press the  button to show the list of teletext contents

(Fast text colored buttons)

Fast text automatically displays the four most commonly used pages that the broadcaster thinks that you may want to choose next. Press the same coloured button on the remote control as the coloured link at the bottom of the teletext page to go directly to that page.

Maintenance

- Early malfunctions can be prevented. Careful and regular cleaning can extend the amount of time you will have your new TV. Be sure to turn the power off and unplug the power cord before you begin any cleaning.

Cleaning the Screen

1. Here's a great way to keep the dust off your screen for a while. Wet a soft cloth in a mixture of lukewarm water and a little fabric softener or dish washing detergent. Wring the cloth until it's almost dry, and then use it to wipe the screen.

2. Make sure the excess water is off the screen, and then let it air-dry before you turn on your TV.

Cleaning the Cabinet

To remove dirt or dust, wipe the cabinet with a soft, dry, lint-free cloth. Please be sure not to use a wet cloth.

Extended Absence

If you expect to leave your TV dormant for a long time (such as a vacation), it's a good idea to unplug the power cord to protect against possible damage from lightning or power surges.

Specifications and functions

| MODEL | | P42A1-AK |
|--------------------------------------|---------------|---|
| Screen | Type | PLASMA DISPLAY PANEL |
| | Viewing angle | >170° (H)/170° (V) |
| | Diagonal | 42" |
| | Color system | PAL, SECAM, NTSC-M |
| TV/VIDEO | Sound system | D/K, I, B/G, M, |
| | Video input | SCART (CVBS, Y/C, RGB), YCbCr |
| DTV YCbCr YPbPr | | 480i/p, 576i/p, 720p, 1080i |
| Sound UPO | | 2x7W |
| Power | | ~ 150-240V 50/60Hz |
| Dimensions (WxHxD)mm (With stand) | | 1050X320X750 |
| Power consumption | | Max.320W |
| Standby consumption | | <3W |
| Condition | | Working temperature: 5°C~35°C Working humidity: 20%-80% Store temperature: -10°C~45°C Store humidity: 5%~90% |

Troubleshooting

For the sake of time and cost, it is strongly recommended that you check out the problem by yourself according to the instructions listed hereunder before contacting the after-sales service for technical assistance.

| | |
|---|--|
| No picture, no sound | Verify if the television is properly plugged. Verify if the television is properly supplied power. Verify if electricity is available. |
| Blank screen | Verify if correct signals are input. Press TV/AV button to change signal input to TV input. Restart the television if power supply is interrupted. |
| No sound | Press Mute button and verify if Mute mode is set. Switch to other channel and verify if the same problem happens. Press VOL+ button to see if the problem can be solved. |
| Poor sound | Verify if sound system is correct. Refer to some chapter for adjust. |
| No picture in some channel | Verify if correct channel is selected. Adjust the antenna. Make adjustments by Fine Tune and Manual Search. |
| No color for some channel program (black and white) | Verify if the same problem exists in other channels. Check out of picture and sound systems. Refer to relative instructions in the Manual for color adjust. |
| Spots with some or all pictures | Verify if the antenna is correctly connected. Verify if the antenna is in good condition. Make fine adjustment of channel. |
| Horizontal/vertical bars or picture shaking | Check for local interference such as an electrical appliance or power tool. |
| Television out of control | Disconnect the television from power supply and, 10 seconds later, connect the television to the power supply. If the problem still exists, contact authorized after-sales service for technical assistance. |

Note: Do not leave the television with static picture in an extended period as it may result in residual image on your television screen.

Note: Production of the plasma screen requires high and precision technologies. However, there might be some dark or bright (red, blue or green) spots, or some anomalous stripes or spots. This is not defect. If the TV set is used in an area 2,400 meters above the sea level where the air pressure is below 750hpa, the picture on the plasma screen may be affected and a muffled sound might be produced. These phenomena might happen in the area 1,500 meters above the sea level. This is resulted from difference between air pressures inside and outside the display. This is not a defect covered by the limited warranty.

NOTE: Design and specifications are subject to change without notice.
The dimension in this manual is a approximation.

Haier

Haier

0090506971G (02)

Free Manuals Download Website

<http://myh66.com>

<http://usermanuals.us>

<http://www.somanuals.com>

<http://www.4manuals.cc>

<http://www.manual-lib.com>

<http://www.404manual.com>

<http://www.luxmanual.com>

<http://aubethermostatmanual.com>

Golf course search by state

<http://golfingnear.com>

Email search by domain

<http://emailbydomain.com>

Auto manuals search

<http://auto.somanuals.com>

TV manuals search

<http://tv.somanuals.com>