

Haier

TFT-LCD TELEVISION OWNER`S MANUAL

*MODELS: P50A11-AK
P60A11-AK*

Haier

Please READ this manual carefully before operating your TV, and retain it for future reference.

Haier

Haier

Congratulations on your purchase, and welcome to the "family"!

Dear Haier product owner:

Thank you for your confidence in Haier. You`ve selected one of the best-built, best-backed products available today. We`ll do everything in our power to keep you happy with your purchase for many years to come.

As a member of the Haier "family," you`re entitled to protection by one of the most comprehensive warranties and outstanding service networks in the industry.

thanks for investing in a Haier product.

CONTENT

BEFORE OPERATING

Warning.....	1
Important Safety Instructions.....	2
Buttons and interface location.....	4
Remote controller.....	6
Remote controller key function.....	7
External equipment connections.....	8

BASIC OPERATING

Switching on/off the TV set.....	14
Choose the Menu language.....	14
Choose the Input Source	14
Searching Channel.....	15
Watching TV Program.....	18
Picture Control Functions.....	19
Sound Control Functions.....	21
Timer Functions.....	23
Function Menu.....	24
Adjust Menu.....	27
Lock Setup	28

OTHERS

Others functions.....	30
Stream media broadcast system.....	31
Maintenance.....	44
Troubleshooting.....	45
Specifications	46
Format.....	47

Accessories



Remote controller



User's manual



Alkaline battery
(AAA)×2



42" : Screws×8
46" : Screws×4



Power cable

Warning



WARNING

RISK OF ELECTRIC SHOCK
DO NOT OPEN



WARNING

TO REDUCE THE RISK OF ELECTRIC SHOCK DO NOT REMOVE COVER (OR BACK). NO USER SERVICEABLE PARTS INSIDE. REFER TO QUALIFIED SERVICE PERSONNEL.

*To avoid electric hazards, it is strongly suggested that the back cover not be opened, as there is no any accessory inside the casing.

*If necessary, please contact authorized after-sales services.

*A lightning flash mark in a triangle: A potentially hazardous situation, which, if not avoided, could result in serious injury by high voltage.

*An exclamation mark in a triangle: Major part or accessory of which technical specifications must be followed if it is to be replaced.

Warning:

To avoid fire or electric hazards, never place your television receiver in an area with heavy moisture. Attention should be paid to avoid accidental scratches or impacts onto the screen.

Caution:

- ▲ Please read this manual carefully before using your television and keep this manual in a good place for future reference.
- ▲ To achieve the best performance of your television, read this User's Manual carefully and properly store it for future reference.
- ▲ Information of screen displays and figures in the User's Manual may vary due to technical innovations.

Caution:

Unauthorized disassembly of this product is prohibited.

Important Safety Instructions

The product should be tightly fixed to avoid drop damages and even fire.



To avoid fire hazards, do not use this product under direct sunlight or closely to heat sources.

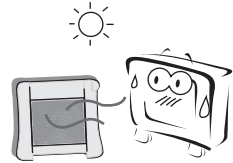

Do not locate the product close to water or oil, which may cause fire hazards.

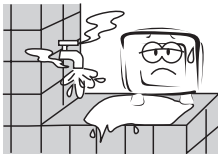

Unplug the power supply and antenna of the product when there is a rainstorm, especially Thunderstorm.



Do not use damaged or worn electric plugs, and keep electric cord away from heat sources to avoid electric shocks or fire hazards.



Do not connect excessive sockets in parallel or share the same socket by multiple plugs to avoid fire hazards.

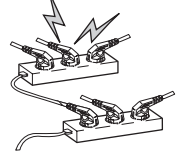

The product must be placed on a solid and stable surface to avoid collapse.

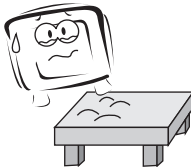

Unauthorized disassembly of the television is prohibited to avoid electric shocks or fire hazards. Contact authorized after-sales service if technical service is needed.

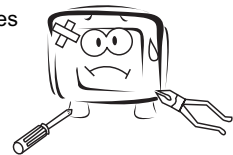

Keep the product away from a transformer or heat source to avoid fire hazards.

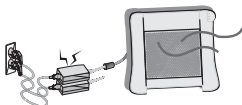

Disconnect the product from power supply and contact authorized after-sales service if abnormal sound is heard in the product.



Important Safety Instructions

Don't use or store inflammable materials near the product to avoid explosion or fire hazards.

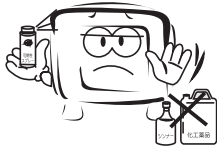

Don't place the product in a humid area to avoid fire hazards.

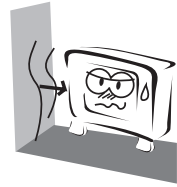

The antenna of the product should be away from electric cable to avoid electric shocks.

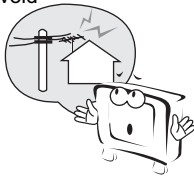

Never touch the plug when your hand is wet as this might cause electric shocks.



Always make sure that the television is well plugged as poor electric connection might cause fire.



When antenna is used, measures should be taken to prevent water from flowing down along the cable into the television.



Unplug the television, use soft fabric, never chemicals, if you are going to make cleaning of the product. Make sure that no water drops in the product.

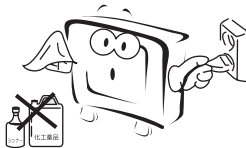

The plug and electric cable must be kept clean to avoid electric shocks or fire hazards.

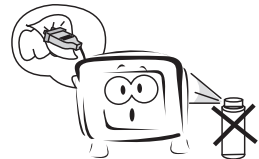

Disconnect the television from power supply and antenna when there is a rainstorm or thunderstorm to avoid electric shocks or fire hazards.

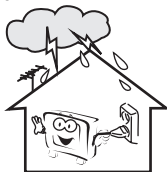

Disconnect the television from power supply to avoid electric shocks or fire hazards in a long vacation.

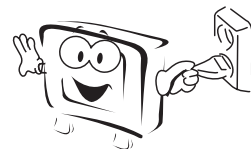

Buttons and interface location

- This is a simplified representation of front panel.
- Here shown may be somewhat different from your TV.

Front panel Control

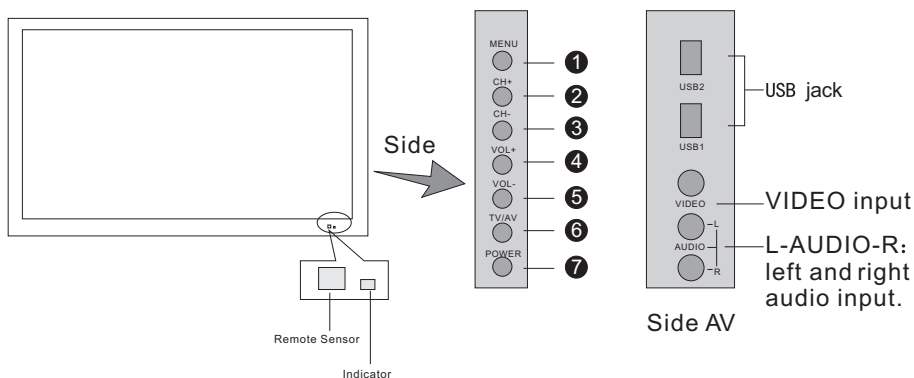

Buttons and functions

1. Menu button
2. Channel number increase
3. Channel number decrease.
4. Volume increase: for enhancing the volume or adjusting MENU.
5. Volume decrease: for lowering the volume or adjusting MENU
6. TV/AV button
7. Power: for turning on or off the power supply.

Buttons and interface location

Rear panel Control

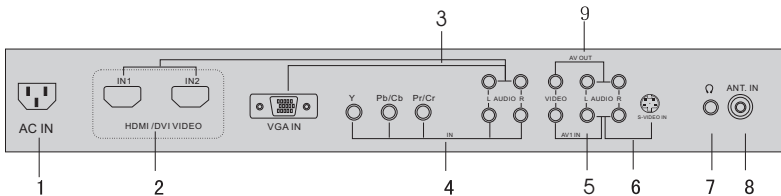

1 AC In: This TV operates on AC power. Never attempt to operate the TV on DC power.

2 HDMI Input: Connect a signal to HDMI/DVI

3 VGA Input: Connect the monitor output connector from a PC to the jack

4 DVD/DTV Input (Component)

Connect a component video/audio device to these jacks.

5. AV1 Input

Connect audio/video out from an audio/video device to these jacks.

6. S-Video Input: Connect S-Video out from a S-Video device to these jacks.

7. Earphone jack Earphone Audio output terminal

8. Antenna Input Connect cable or antenna signals to the TV, either directly or through your cable box.

9. Video/Audio output terminal

Connect ordinary video/audio or other appliance audio input terminals.

Remote controller

Battery loading

1. Slide open the cover of the battery compartment on the back of the remote controller.
2. Load two 7# (AAA) alkaline batteries in the compartment. (plus and minus poles to respective mark)
3. Replace the cover of the battery compartment.

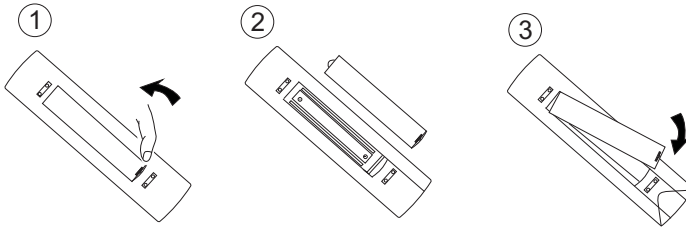

Precautions

As strong light may interfere the signals, change your position to operate the remote controller if the television cannot be turned on or off as you expect.



Make sure that two AA alkaline batteries are loaded. The batteries must be of the same type. The batteries must be located properly. The batteries are not rechargeable.

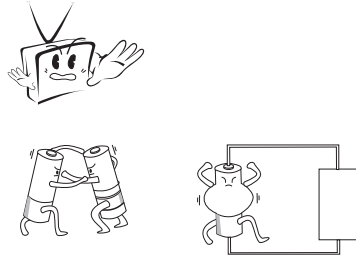

Keep the remote controller away from heat source or humid area to ensure effective performance of the remote controller.

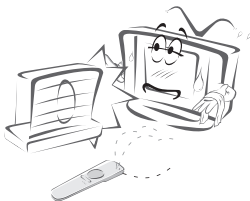

Make sure that there is no obstacle between the remote controller and television set.

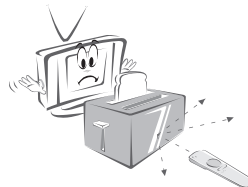

Remote controller key function

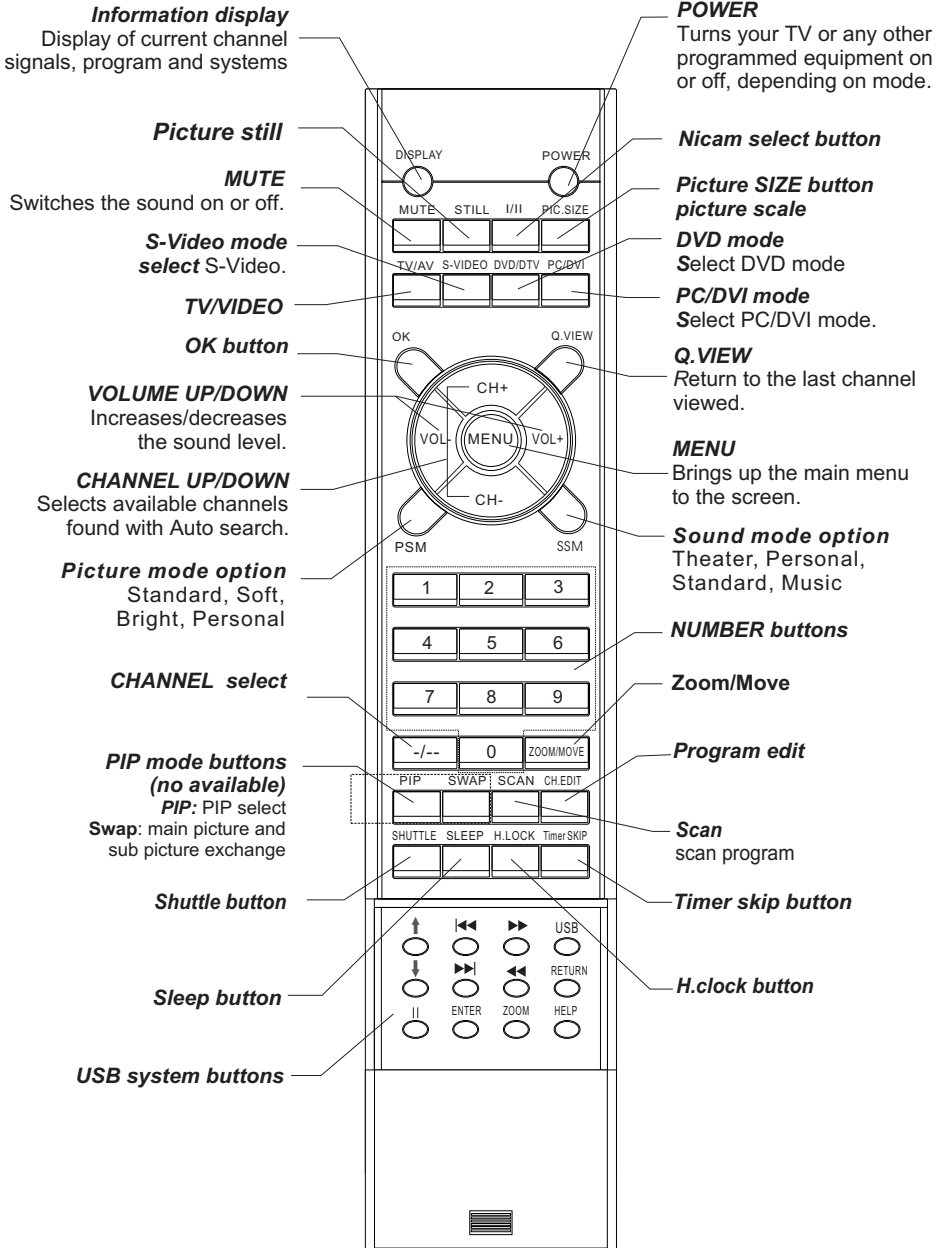

External Equipment Connections

Antenna Connection

- Antenna or Cable Service without a Cable Box Connections
- For optimum picture quality, adjust antenna direction if needed.

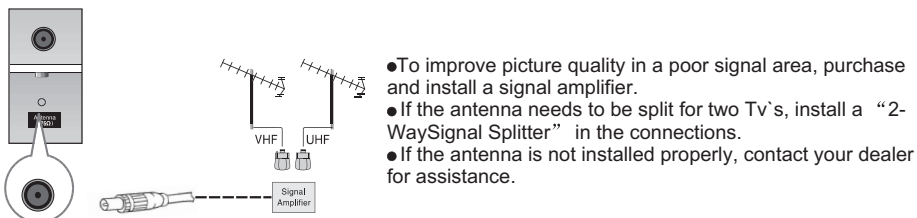
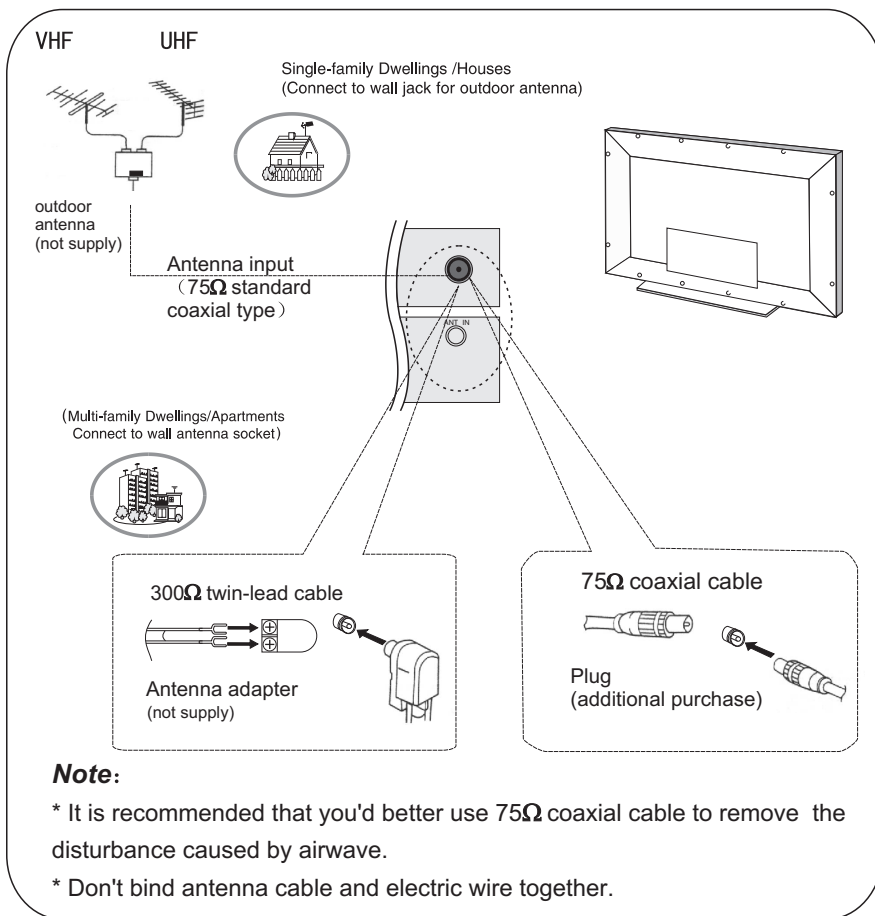

External Equipment Connections

NOTE: All cables shown are not included with the TV.

Choose Your Connection

There are several ways to connect your television, depending on the components you want to connect and the quality of the signal you want to achieve. The following are examples of some ways to connect your TV.

Choose the connection which is best for you.

VCR Connection

- To avoid picture noise (interference), leave an adequate distance between the VCR and TV.

Connection Option 1

Set VCR output switch to channel 3 or 4 and then tune the TV to the same channel number.

Connection Option 2

1. Connect the audio and video cables from the VCR's output jacks to the TV input jacks, as shown in the figure.

When connecting the TV to VCR, match the jack colors (Video = yellow, Audio Left = white, and Audio Right = red).

If you connect an S-VIDEO output from VCR to the S-VIDEO input, the picture quality is improved; compared to connecting a regular VCR to the Video input.

2. Insert a video tape into the VCR and press PLAY on the VCR. (Refer to the VCR owner's manual.)

3. Select the input source with using the INPUT button on the remote control, and then press CH+/- button to select the source, press the VOL+ button to confirm.

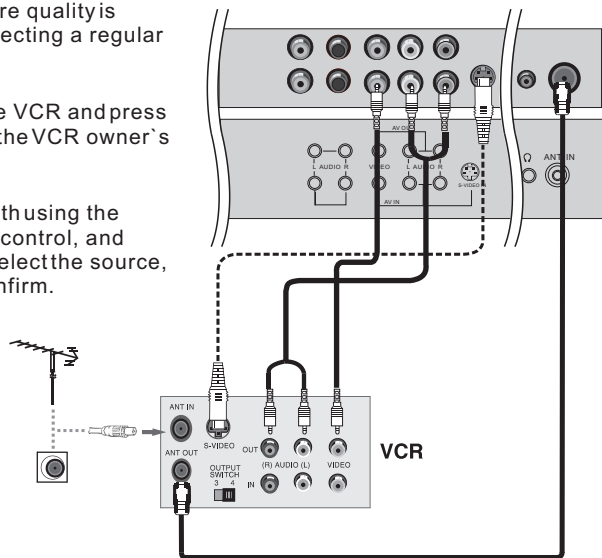

External Equipment Connections

DVD Setup

How to connect

1. Connect the DVD video outputs (Y, Pb/Cb, Pr/Cr) to the COMPONENT (Y, Pb/Cb, Pr/Cr) input jacks on the TV and connect the DVD audio outputs to the AUDIO jacks on the TV, as shown in the figure.
2. If your DVD only has an S-Video output jack, connect this to the S-VIDEO input on the TV and Connect the DVD audio outputs to the AV IN jacks on the TV, as shown in the figure.

NOTE: If your DVD player does not have component video output, use S-Video.

How to use

1. Turn on the DVD player, insert a DVD.
2. Use the S-Video button on the remote control to select S-VIDEO or YPbPr/YCbCr mode.
3. Press Play button on external equipment for program play.
4. Refer to the DVD player's manual for operating instructions.

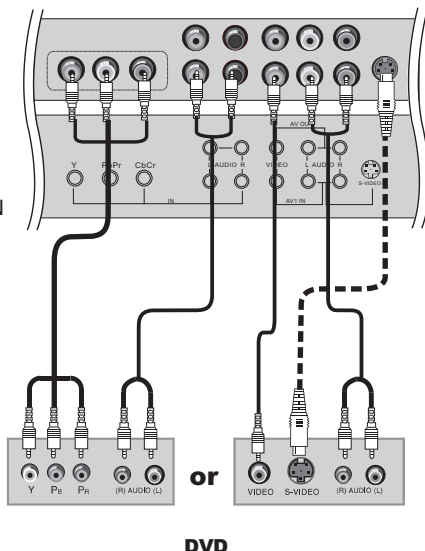

HDMI or DVI Setup

-To watch digitally broadcast programs, purchase and connect a digital set-top box.

How to connect

Use the TV's COMPONENT (Y, Pb/Cb, Pr/Cr) INPUT jacks, VGA or HDMI port for video connections, depending on your set-top box connections available. Then, make the corresponding audio connections.

How to use

1. Turn on the digital set-top box. (Refer to the owner's manual for the digital set-top box.)
2. Use TV/AV on the remote control to select VGA or HDMI (Y, Pb/Cb, Pr/Cr) mode.
3. Press Play button on external equipment for program play.

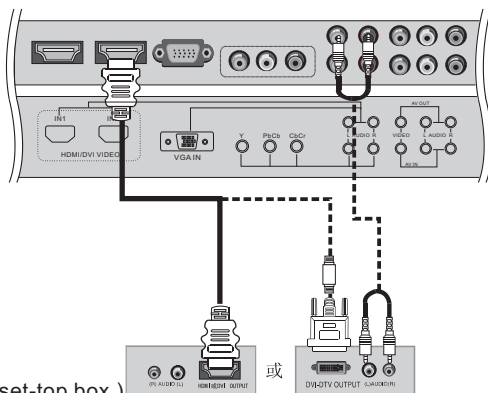

External Equipment Connections

PC Setup

How to connect

1. Use the TV's VGA IN port for video connections.
2. Then, make the corresponding audio connection. If using a sound card, adjust the PC sound as required.

How to use

1. Turn on the PC and the TV.
2. Turn on the display by pressing the POWER button on the TV's remote control.
3. Use PC/DVI on the remote control to select VGA source.
4. Check the image on your TV. There may be noise associated with the resolution, vertical pattern, contrast or brightness in PC mode. If noise is present, change the PC mode to another resolution, change the refresh rate to another rate or adjust the brightness and contrast on the menu until the picture is clear. If the refresh rate of the PC graphic card can not be changed, change the PC graphic card or consult the manufacturer of the PC graphic card.

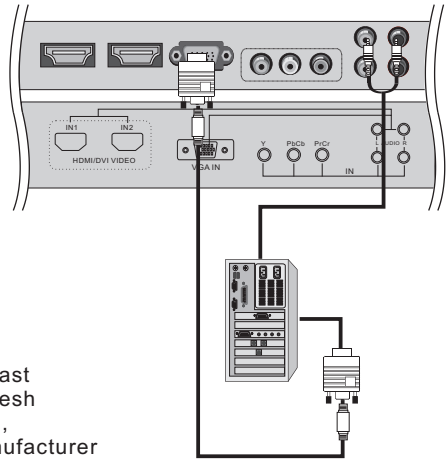

NOTES:

- 1 Avoid keeping a fixed image on the TV's screen for a long period of Time. The fixed image may become permanently imprinted on the screen.
- 2 The synchronization input form for Horizontal and Vertical frequencies is separate.
- 3 To obtain the best picture, do not play the USB, YPbPr, HDMI or VGA source at the same time.

Monitor Out Setup

The TV has a special signal output capability which allows you to hookup a second TV or monitor.

Connect the second TV or monitor to the TV's AV OUT. See the Operating Manual of the second TV or monitor for further details regarding that device's input settings.

Notes:

- YPbPr, VGA, HDMI, S-Video input sources cannot be used for Monitor out.
- When connecting with external audio equipments, such as amplifiers or speakers, please turn the TV speakers off.

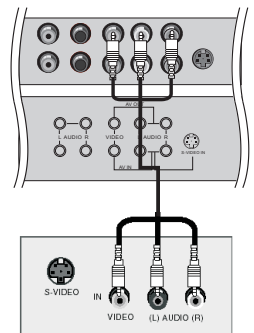

External Equipment Connections

Connecting Headphones

You can connect a set of headphones to your set if you wish to watch a TV programme without disturbing the other people in the room.

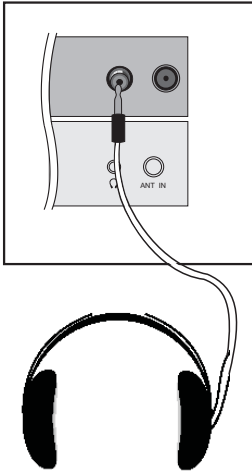

Plug a set of headphones into the 3.5mm mini-jack socket on the rear panel of the set.

Note:

- Prolonged use of headphones at a high volume may damage your hearing.
- You will not receive sound from the speakers when you connect headphones to the system.

Power source

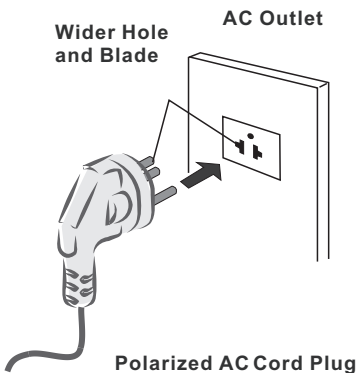

TO USE AC POWER SOURCE

Use the AC polarized line cord provided for operation on AC. Insert the AC cord plug into a standard polarized AC outlet.

NOTES:

- Never connect the AC line cord plug to other than the specified voltage. Use the attached power cord only.
 - If the polarized AC cord does not fit into a non-polarized AC outlet, do not attempt to file or cut the blade. It is the user's responsibility to have an electrician replace the obsolete outlet.
 - If you cause a static discharge when touching the unit and the unit fails to function, simply unplug the unit from the AC outlet and plug it back in. The unit should return to normal operation.
- Polarized AC Cord Plug.

Switching ON/OFF the TV set

In the manual, the OSD (on screen display) may be different from your TV's because it is just an example to help you with the TV operation.

Switching ON/OFF the TV set

- 1 Please press down the power switch to switch on AC power supply and the power indicator will light .
- 2 If the indicator is lighting in red, press POWER button on the remote control again.
- 3 If you want to exchange to standing by status, please press down POWER button on the remote controller.
- 4 If you want to fully switch off the powersupply for the TV set, please press down the power switch button on the TV set.

Choose the Menu Language

When you start using your set for the first Time, you must select the language which will be used for displaying menus and indications.

- 1 Press **MENU** and **VOL+/-** button to select the **Function Menu**.
- 2 Press **VOL+** button and use **CH+/-** button to select **Menu Set**.
- 3 Press **VOL+** button and use **CH+/-** button to select **Language**.
- 4 Select a particular language by pressing **VOL+/-** button repeatedly.
You can choose one of two languages.(Chinese or English)
- 5 When you are satisfied with your choice, press **MENU** button to return to normal viewing.

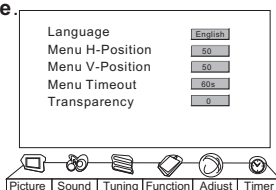

Choose the Input Source

If you hope to enjoy the picture from the external input source, before to select the source, you need to connect the devices, otherwise, when you select the source, the none or no signal will appears on the screen.

Press **TV/AV** button on remote control, the menu appears on the screen. Then press **CH+/-** to select the TV item, and press **VOL+/-** to ensure it.

Before watching TV program, you need to ensure your TV in TV mode.

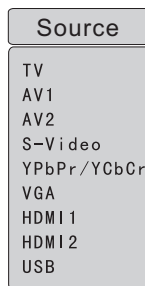

Searching Channel

- This TV set has three methods to set channels, which are respectively full automatic, manual search, fine tune.
- In this section, how to use the remote control to set channel is explained. You can also use buttons on the TV set to set channel.

Automatic search

1 Press MENU button and then use VOL+/- button to select the Tuning menu.

Note : 1. the **Tuning** menu will be only operated in normal TV mode;
2. When the Tuning Lock is setting as Off, it is selectable.

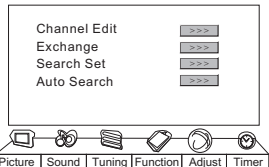

2 Press VOL+ button and then use CH+/- button to select "Auto Search" item.

3 Press VOL+ button to ensure automatic search function work.

After the search has finished, all channels now playing program will be automatically preset in order and backtrack the 0 channel.

4 Press MENU button to stop automatic search function.

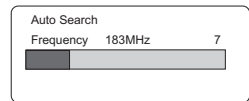

Manual search

If excessive channel signal of unwanted programs are received in local area, manual search function is recommended.

1 Press MENU button and then use VOL+/- button to select the Tuning menu.

2 Press VOL+ button and then use CH+/- button to select "Search Set" item.

3 Press VOL+ button to enter the submenu.

4 Press CH+/- button to select Search option, and use VOL+/- button to start searching.

When searching successfully for the channel, the Manual search stopping automatically and save to the current channel.

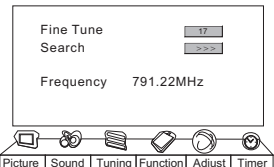
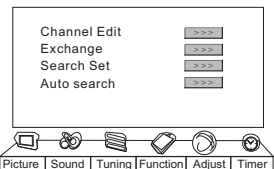

5 Press OK or MENU button to stop searching.

Fine tune

If the picture and/or sound are poor, try using the FINE TUNE feature. Do not use this feature unless reception is poor.

1 Repeat above steps 1-3, then press CH+/- button to select the **Fine Tune** item.

2 Press VOL-/+ button repeatedly to carry out fine tune, till the best picture and sound are obtained, then loosen the button.

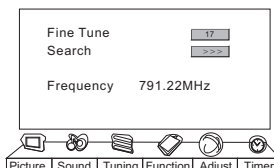

Searching Channel

Channel Edit

- 1 Press MENU button and then use VOL+/- button to select the Tuning menu.
- 2 Press VOL+ button and then use CH+/- button to select Channel Edit item.
- 3 Press VOL+ to enter the submenu.
- 4 Press CH+/- button to select the item to adjust, and press VOL+/- button to adjust the item to select.

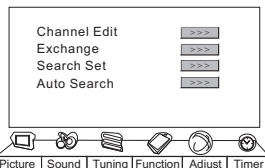

■ Channel No.

Press VOL+/- button to select the channel number to edit.

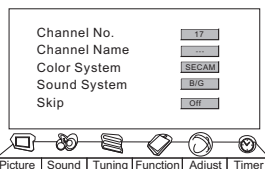

■ Channel Name

This will adjust the channel name.

Press VOL+/- button to move the cursor, and then use CH+/- button to select the letter, then press MENU or OK button to confirm.

■ Color System

Press CH+/- button to select "Color System", then press VOL-/+ button to select the correct color system. In general, you can set it as "AUTO".

■ Sound System

Press CH+/- button to select "Sound System", then press VOL-/+ button to select the correct sound system.

■ Skip

After the programs are presetting, you can skip some programs so that to select your favorite channels only.

Press VOL-/+ button to set **Skip** as **On**.

If you want to recover the skipped channel

1. Use Direct-digit Choosing button to select the number of the channel to be recovered.
2. Do the above steps again.
3. Press VOL+/- button to set **Skip** as **Off**.

Searching Channel

Channel Exchange

- 1 Press MENU button and then use VOL+/- button to select the Tuning menu.
- 2 Press VOL+ button and then use CH+/- button to select "Exchange" item.
- 3 Press VOL+ to enter the submenu.
- 4 Press CH+/- button to select the To Channel item, and use VOL+/- button to set the desired channel number.
- 5 When you are satisfied with your choice, press CH+/- button to select Exchange item, and then press VOL+ button to confirm, at this time, the **Exchange OK!** will display on the screen.

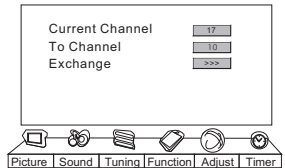
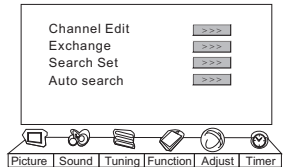

Watching TV Program

You can watch TV program in a presetting channel.

To select the TV mode

Before watching TV program, you may ensure your TV in TV mode.
Press TV/AV button to select TV mode.

How to select the desired program

1 Using "Program number" buttons.

- Directly enter the channel number with the numeric keypad on the remote control.
If to select channel numbers of double-digit or three-figure, press continuously the numeric buttons in three second.

2 Using CH+/- button.

- Press the CH+ button to select a channel number in number increasing direction.
- Press the CH- button to select a channel number in number decreasing direction.

How to select the desired sound

Press VOL+/- button on the remote or the front of the TV set to adjust the volume level. The range is 0~100.
When the volume button are pressed the volume level is displayed automatically on the TV screen.

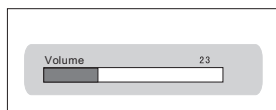

Quick program view

This function enables quick swap to the last watched program.

1 Suppose the channel number you used just now is 8 and the channel number you are using is 18 (as shown in the figure).

2 If you want to return to the last watched program channel 8, you can simply press the Q.View button.

3 If you want to return to channel 18, press the button again. Use this function, you can easily change between the channel you are using and the channel you used last Time.

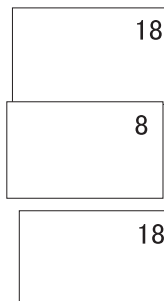

Shuttle function

Shuttle function enables quick swap to setting program.

Press **SHUTTLE** button about 3 second, and the display **Channel Stored** on the screen, at the time, you may operate other, then if you scan over program, you may press again shuttle button to return to the setting program.

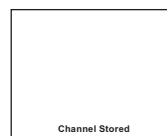

Picture Control Functions

The TV menu gives you an overview of the menus you can select.
 Note: Depending on the input signal, one or more menu items may not be selectable.

How to select picture modes

You can quickly select the desired picture mode from three preset modes and one customized mode.

Press the PSM button to select the desired picture quality. Four kinds of picture modes (i.e., "Standard", "Bright", "Soft", "Personal") can be selected in turn.

- Personal: A spare setting that can be adjusted to personal tastes
- Standard: Designed for rooms that have good all round lighting
- Soft: Designed for nighttime low light viewing
- Bright: Designed for rooms with high ambient lighting such as day time sport;

How to customize your own picture status

- 1 Press MENU button and then use VOL+/- button to select **Picture** menu .
- 2 Press VOL+ button and then use CH+/- button to select the item to be adjusted, then press VOL+/- button to obtain the desired effect.

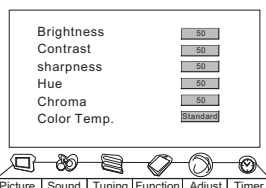

ITEM	Press VOL-	Press VOL+
Brightness	Dark	Bright
Contrast	Weak	Strong
Sharpness	Soft	Sharp
Chroma	Shallow	Deep
Hue (only in NTSC mode)	More green	More purple

NOTE :
 When Personal mode is not selected, the Personal mode can be entered automatically if Contrast, Brightness, Color, Hue and Sharpness parameters are adjusted.

Color Temperature

This will increase or decrease **Warm** (red) and **Cool** (blue) colors to suit personal preferences.
 Select **Cool** to give the white colors a blue tint, **Standard** to give the white colors a neutral tint, **Warm** to give the white colors a red tint.

- 1 Press MENU button and then use VOL+/- button to select **Picture** menu .
- 2 Press VOL+ button and then use CH+/- button to select Color Temp. Item, and then press VOL+/- button to select the desired effect.

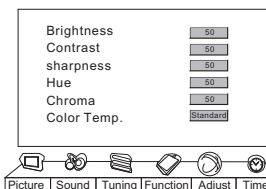

Picture Control Functions

Aspect Ratio Control

Press the **PIC.SIZE** button the Aspect Ratio menu appearance on the screen.

■ 4:3 mode

Choose **4:3** when you want to view a picture with an original 4:3 aspect ratio, with gray bars appearing at both the left and right sides.

■ Full Screen

Choose **Full Screen** when you want to adjust the picture horizontally, in a linear proportion to fill the entire screen.

■ Wide Screen

Choose **Wide Screen** when you want to view the picture to be altered, both vertically and horizontally extended and cropped.

Note: 1. If a fixed image is displayed on the screen for a long time, it image may become imprinted on the screen and remain visible.
2. In **VGA** mode, there are only 4:3 and Full screen modes.

Sound Control Functions

How to choose sound mode

You can quickly select the desired sound mode from four preset modes and one customized mode.

Press the **SSM** button to select the desired sound quality. Five kinds of sound modes (i.e., "Standard", "Personal", "Theater", "News" and "Music") can be selected in turn.

- **Personal:** A spare setting that can be adjusted to personal tastes
- **Standard:** Normal sound with moderate bass and treble setting
- **Music:** Designed the sound to best suit music programs
- **Theater:** Enables extra bass and treble to enhance the movie experience;
- **News:** Designed to reduce the bass and treble which enhances the voice for news programs

Equalizer

- 1 Press MENU button and then use VOL+/- button to select **Sound** menu .
- 2 Press VOL+ button and then use CH+/- button to select Equalizer item, then press VOL+/- button to enter the submenu.
- 3 Press VOL+/- button to select the item to be adjusted, then press CH+/- button to obtain the desired effect.

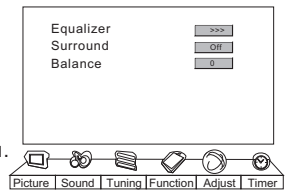

Balance

This will adjust the output of the right and left speakers to obtain the best stereo reproduction for your listening position.

The intermediate value is 0. When indication value of Balance increases toward +50, sound of the right and left speaker becomes stronger and weaker, respectively. When indication value of Balance decreases toward -50, sound of the right and left speaker becomes weaker and stronger.

Press CH+/- button to select **Balance**,
Press VOL+ button to increase the audio output in the right speaker;
press VOL- button to increase the audio output in the left speaker.

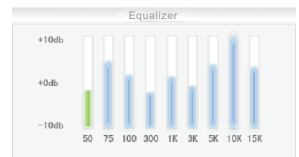

Surround Sound

The surround sound feature expands the audio listening field wider and deeper to create exceptional sound quality from the TV's speakers.

Press CH+/- button to select **Surround**,
press VOL+/- button to set Surround as **Off** or **On**

Sound Control Functions

Eliminate Sound

When you need to pay attention to surrounded sounds, or there is a telephone calling you or there are some guests visiting you, the sound elimination (mute) function is very convenient.

1 Press the MUTE button on the remote control and "Mute" type face will display on the lower part of the screen. At this Time, the sound of the TV set is turned off.

2 If you want to recover the sound, press the MUTE button again or directly press VOL+ button.

Timer Functions

Current time setting

The current time will only work if the TV set is turned on or in standby. When the set is disconnected from the power supply or is turned off by the main power on the rear panel, the current time loses power and will need to be reset when the power is reconnected.

1 Press MENU button and then use VOL+/- button to select **Timer** menu .

2 Press VOL+ button and then use CH+/- button to select **Current Time**, and then press VOL+/- button to select hour or minute position, and then press CH+/- button to set the value of hour or minute.

3 Press MENU button to return to the previous menu.

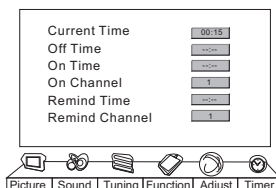

On/Off Time

Using on/off Time function, the TV set can automatically turn on to a preset program or shut down in a preset time. When the set is disconnected from the power supply or is turned off by the main power, the on/off time loses.

1 Press CH+/- button to select On Time, press VOL+/- button to select hour or minute position; then press CH+/- button to set the value of hours or minutes.

2 Press CH+/- button to select On Channel, then press CH+/- button to select your desired channel.

3 Repeat step 1-2 to set Off Time item.

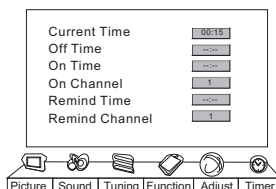

Remind Time and Remind Program

Program remind Time, that displays an on-screen reminder prompt, when a program on a different channel is due to start.

1 Press MENU button and then use VOL+/- button to select **Timer** menu .

2 Press VOL+ button and then use CH+/- button to select **Remind Time**, and then press VOL+/- button to select hour or minute position, and then press CH+/- button to set the value of hour or minute, then press MENU or OK button to confirm.

3 Press CH+/- button to select **Remind Channel**, and then VOL+/- button to select the channel number.

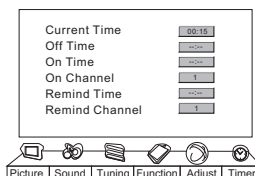

Function Menu

Menu Set

- 1 Press MENU button and then use VOL+/- button to select **Function** menu .
- 2 Press VOL+ button and then use CH+/- button to select **Menu Set**, and then press VOL+ button to enter the submenu.
- 3 Press CH+/- button to select the item to be adjusted, then press VOL+/- button to adjust the desired value.

■ Language

To select the menu language.

■ Menu H-Position

To adjust the menu H-position, press VOL- button to move menu toward left, press VOL+ button to move menu toward right.

■ Menu V-Position

To adjust the menu V-position, press VOL- button to move menu toward down, press VOL+ button to move menu toward up.

■ Menu Timeout

Each Press of VOL+/- button repeatedly to select the number of preset minutes, the Time will be set in sequence: 5s, 10s, 15s, 20s, 25s, 30s, 35s, 40s, 45s, 50s, 55s, 60s.

■ Transparency

To set transparency background of OSD.

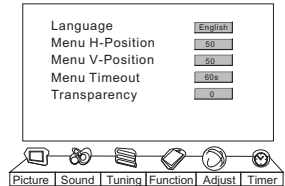
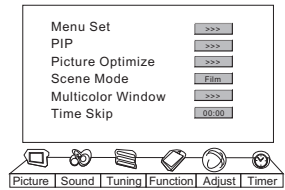

Picture In Picture

- 1 Press MENU button and then use VOL+/- button to select **Function** menu .
- 2 Press VOL+ button and then use CH+/- button to select **PIP**, and then press VOL+ button to enter the submenu.
- 3 Press CH+/- button to select the item to be adjusted, then press VOL+/- button to adjust the desired value.

■ PIP Size

To select the PIP menu size. Press VOL+ button to select the desired size. Five kinds of sizes (i.e., Small, Large, POP, PBP and Off) can be selected in turn.

■ PIP Source

To select the PIP picture source. Press VOL+ button to select the desired source.

■ PIP H-Position

To adjust the PIP menu H-position, press VOL+ button to move menu toward right, press VOL- button to move menu toward left.

■ PIP V-Position

To adjust the PIP menu V-position, press VOL+ button to move menu toward down, press VOL- button to move menu toward up.

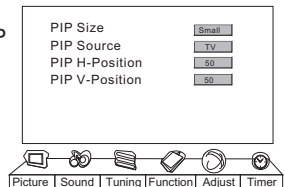
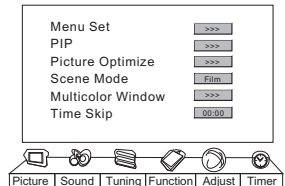

Note: In Lock Set, if the source lock is set as on, the PIP source is not available.

Function Menu

Picture Optimize

- 1 Press MENU button and then use VOL+/- button to select **Function** menu .
- 2 Press VOL+ button and then use CH+/- button to select Picture Optimize, and then press the VOL+ button to enter the submenu.
- 3 Press CH+/- button to select the item to be adjusted, then press VOL+/- button to adjust the desired value.

■ 3A Optimize

The 3A optimize tracks picture contrast and color to improve the quality of picture in terms of brightness and sharpness. Repeat step 3 to set **3A optimize** as **on** or **off**.

■ MADI (Motion, Adaption De-Interlacing)

To select the sport mode.

Press VOL+ button to select the desired mode.

Five kinds of sources (i.e., Standard, Theater, Personal, and Music) can be selected in turn.

■ DCDI (Directional Correlational De-Interlacing)

To adjust and improves picture quality.

■ CCS (Gross Color and Control)

To adjust and improves picture quality.

■ 3DNR (3D Noise Reduction)

Automatically filters out and reduces the image noise and improves picture quality when receiving weak video signals. Select **Off/Auto/Low/Medium /High** according to the image noise of the broadcast signal.

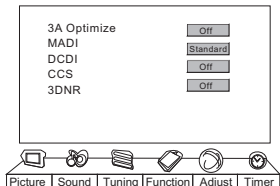
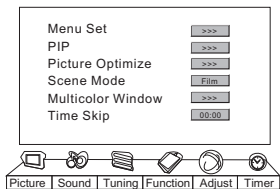

Scene Mode

- 1 Press MENU button and then use VOL+/- button to select **Function** menu .
- 2 Press VOL+ button and then use CH+/- button to **Scene Mode** option.
- 3 Press VOL+/- button to select the Film, Vivid, Nature, Sport in turn.

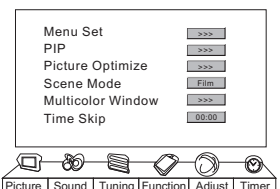

Function menu

Multicolor Window

- 1 Press MENU button and then use VOL+/- button to select **Function** menu .
- 2 Press VOL+ button and then use CH+/- button to select **Multicolor Window**, and then press VOL+ button to start.

Note:

1. In PIP On, the function will not be available.
2. In VGA mode, the function will not be available.
3. When the scene mode set as on, the function will not be available.
4. In 4:3 and full screen mode, the Mult-color Window will not be available.

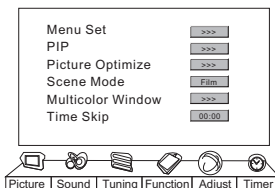

Time Skip

- 1 Press MENU button and then use VOL+/- button to select **Function** menu .
- 2 Press VOL+ button and then use CH+/- button to select **Time Skip**, and then press VOL+ button to set the desired time.

Note:

1. If prior to the completion of the countdown time, press the Timer Skip button, the function will be canceled.
2. The function will be available in TV mode.
3. After start-up timeskip function, if switched to other sources, the function automatically canceled.

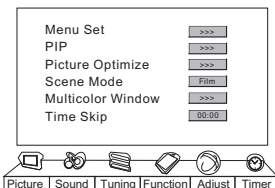

Adjust Menu

In VGA input mode , H-Position and V-Position can be used to adjust the picture position.

When VGA、HDMI input mode is set

1 Press MENU button and then use VOL+/- button to select **Adjust** menu .

2 Press the VOL+ button and then use CH+/- button to select the item to be adjusted, then press the VOL+/- button to adjust the desired value.

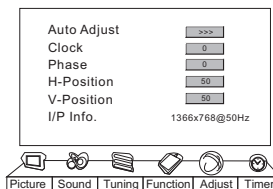

■ Auto Adjust

This is used to reset the default setting parameters (After the operation, Auto Adjusting will be display on the screen)

■ Clock

This is used for adjusting H Position and V Position as well as relative parameters in VGA modes.

■ Phase

This is used for adjusting the phase of pixel clock in VGA mode.

■ H Position

Horizontal position of picture can be adjusted in this item.

■ V Position

Vertical position of picture can be adjusted in this item.

Note:

- 1.As adjusting H position or V position parameter, It is natural that the picture will have faintness once in a while if the range is more, then to adjust contrarily to normal position.
- 2.As the frequency of display differ in PC device, you may select the appropriate frequency to obtain desired effect. If the signal of receive is excess, the picture can be not displayed or wrong on the screen.

Lock Setup

The television has the function of security default lock. Password needs to be entered when the program lock mode is to be set.

How to use the password function

Press H.LOCK button, Password will appear on the screen.



The initial password of the television is 0000. When the password achieved, the Lock Set menu will display on the screen. (as follow)

Note: If the password is not correctly entered, you will be required to reenter the password and the cursor will stay at the first place.

Press MENU to cancel the window.

Note: The Tuning Lock and Source Lock will be only useful in TV mode.

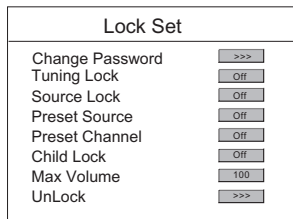

To set new Password

The password can be changed.

After entering the Lock set menu, Press CH+/- to select **password**, Press vol+ button, the screen will display the follow.

Press the digit buttons, If correct password is entered, the change successful will display on the screen, at this time, the old password will be changed.

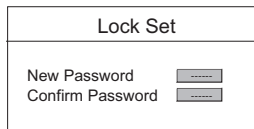

Tuning Lock

Press CH+/- to select Tuner Lock and VOL+/- to set On/Off. (To set On, some operation such as search will be not available. When enter the Tuning menu, Tuner Lock will be on the screen, and the Timer will be the same with the main menu if no operation. If you want to operate Tuning menu, you need to enter the Lock menu to set Tuner Lock Off or operate UnLock.

Source Lock

Source Lock will control the ON or OFF of hinder external input modes.

Press VOL+ button to set as on or off.

When the source lock is set as on, TV source will display, at this time, when press TV/AV, S-VIDEO, DVD/DTV, PC/DVI button, the TV can not switch to corresponding source and the Source Lock will display on the screen.

Preset Source

Preset Source is opted for setting up start source.

Press VOL+/- button to select Off, TV, AV1, AV2, S-Video, YPbPr/YCbCr, VGA, HDMI1, HDMI2, VGA, USB in turn.

Lock Setup

Preset Channel

Preset Channel is opted for setting up preset channel. Press **CH+/-** button to select preset Channel. Press **VOL+/-** button, to select channel number. (The item is not available except TV signal.)

Child Lock

Press **CH+/-** button to select Child Lock. Press **VOL+/-** button to set **On** or **Off** mode. If lock on mode is set, Child Lock is in activated automatically. In such case, if Child Lock button (button on the television) is pressed, the screen will display **Child Lock**, which can be erased by press of MENU button. 5 seconds later after the latest press, the screen display will disappear automatically. The Child Lock mode can be resumed by entering Lock Set menu, set Child Lock **On** or **Off**.

Max Volume

Press **CH+/-** button to select Max Volume. Press **VOL+/-** button for adjustment between 0~100. If a certain value is set, when volume is being adjusted, the sound value can not exceed maximum volume value. If current volume is over Max Volume, when Lock Set menu is set, current volume will become set maximum volume. If current volume is below maximum volume, customer set volume will stay unchanged.

UnLock

Press **CH+/-** button to select Unlock mode. Press **VOL+/-** button to unlock all set modes, setting all lock options to off, and the maximum volume returns to 100.

Other functions

NICAM

Press the I/II button will result in fast swap of **NICAM** function of current program.

Display function

Press the DISPLAY button, then the channel number and system will be displayed on the screen.
Press the DISPLAY button again, it is disappear.

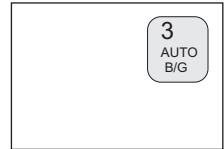

STILL

Press the STILL button, the STILL will display on the screen, at this time, the picture of TV is still, and press the STILL button again, the picture will resume.

Sleep

The TV set will switch automatically to standby at the preset time with the SLEEP timer on. You may set the sleep time.

each press of **SLEEP** button repeatedly on the remote control to select the number of preset minutes, the time will be set in sequence: (**off, 10, 20, 30, 60, 90, 120, 150, 180**).

To confirm the sleep time setting, press **SLEEP** and the remaining time will be displayed for a few seconds.

To cancel the sleep time, press **SLEEP** repeatedly until the display turns to **off**.

Channel edit setup

1 Press CH.EDIT button to open/close the Channel Name menu,
Note: opens when automatically will select the current channel number.

2 Press CH+/- button to select the desired channel number, and then press OK button to confirm.

3 Press VOL+ button to move the cursor, and then use CH+/- button to alter the letter.

4 When you are satisfied with your change, press the **EXIT** button to return to normal viewing or press **MENU** button to return to the previous menu.

No.	Channel Name
0	-----
1	-----
2	-----
3	-----
4	-----
5	-----
6	-----
7	-----

Scan

This function fast glances over the channels (Skip as off) which each searches.

Press the SCAN button to start from the current channel, and switch a channel every 3 seconds, after scanning, and the program channel stop the current channel.

If you want to stop the function during auto tuning, simply press **Scan** or **MENU** button again, at this time, the program will stop the program. Finally glances over.

Stream media broadcast system

Stream media play prepare

1. Supporting equipment

1. Equipment supporting Mass and Storage agreements include USB, mobile hard disk, card reader, some MP3 and digital camera.

2. Equipment supporting PTP agreement includes some digital camera.

2.1 Supporting media:

picture, music, MPEG4, MPEG2 and MPEG1;

Supporting file format:

*.Avi, *.DIVX, *.MPEG, *.DAT, *.MP3, *.WMA, *.JPG and *.JPEG. Due to particularity of file code and file mode, It is possible that some files cannot be read.

2 If Pic & Music mode is activated, relative media file format will include JPEG and MP3 files. After Picture is selected, MP3 files set for play will open both music and picture files for sync play performance. As some files must be read while music is being played, the speed of picture operation response might be affected.

3. Before starting operation, verify USB storage device is of FAT32 and FAT file system format. At present, this television does not support NTFS and the file system of other format.

4. Many movie files use suffix of AVI and MPG. However, many kinds of format

are used for internal files. This television can only play some AVI and MPG files of this format. Those files with suffix of dat are not movie files, but data files used by computers, and cannot be played for movies.

5. External card reader supports most digital cards available in the market. Readable digital cards are classified according to the property of card readers and can be connected to mobile hard disks (working voltage 5.0V, working current not over 500mA).

6. Some Time the television operation may be halted due to excessive rate of information code errors. In such case, restart the system. As there are many nonstandard USB mobile devices in the market. If this kind of USB mobile devices are used in the stream media play system, the problem of identification failure might occur. The same problem may also happen with computers, not televisions.

7. It is suggested that the external devices with USB2.0 interface be used to improve velocity of information reading and continuity of information play.

Stream media broadcast system

Stream media system setup

Note: Memory cards or USB devices are not supplied with this TV.

USB setup

- 1 Insert USB in the card slots at the front of TV.
- 2 Insert it to be clicked in.
- 3 Press USB button on the remote controller to enter the stream media system.

CARD setup

This TV is Compatible with the card of SD/MMC/CF/MS format.

How to use

1、 Jack of card Instructions:

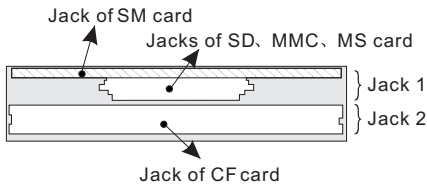

Note

1. Please note chooses uses the digital memory card with you corresponds the receptacle
2. Card reader in 1 cannot simultaneously insert two kind of cards in the graphical representation position

2、 Insert the card as right direction. As following Card in common use

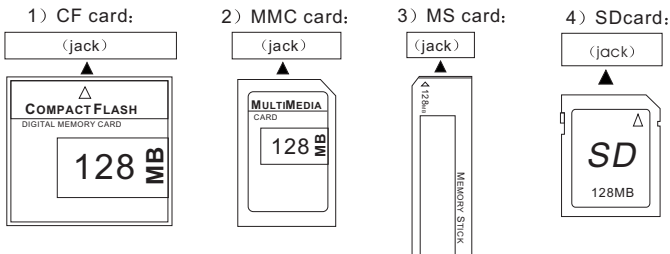

Note:

1. the card insertion time, after the flows media system starts 2s , insert the card to numerical code card reader , do not bring card to start flow media system.
2. After card insertion, indicator light will shines, and enters glitters condition, after period of time , indicator light enters constant bright condition, indicates already distinguishes finished, this time carries on play operation and so on .
3. In the market , the digital card type are very many, please uses standard product of the standard factory , meets reads takes difficult or reads speed limits, please replaces the digital card.

Stream media broadcast system

Card data protection

- Do not remove the card/USB device when the content is being read or when browsing. Such action may damage the memory card/USB device.
- Do not touch the terminals on the back of the card.
- Always insert a card in the correct direction. Failure to do so may result in damage to the card and the unit.
- Do not subject the card to excessive pressure or strong impacts.
- Malfunctions of the unit or card may result in data loss or damage to the card.
- Haier shall not accept any liability for damage or loss of stored data.



Warning:

Memory cards can be swallowed by young children. Do not allow children to handle memory cards. Please remove the memory card immediately after use.

Stream media broadcast system

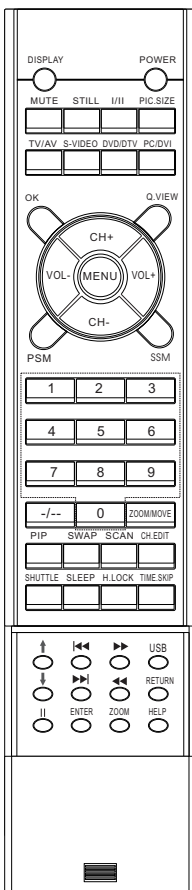

To start the media play

- 1 Press the USB button on the remote to enter stream media system.
- 2 The system start up about 2 seconds, and then insert USB in the card slots
- 3 Press \uparrow or \downarrow to select the desired item, and press ENTER button to ensure it.
- 4 If to cancel the stream media system, press EXIT button to return to the main menu, and then press TV/AV button to select TV source.

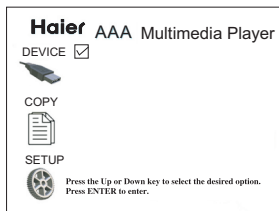

Note: If there are no operation two minutes later, the TV will enter the saver automatically, at the time, press any button of USB system (with the exception of USB button) to exit the saver menu.

To operate the menu

1. Press \uparrow or \downarrow to select the item with up or down.
2. Press \leftarrow or \rightarrow to select the desired item of submenu with left or right.
3. Press ENTER button to ensure the desired option, to enter the submenu. to resume the speed of standard.
4. Press \rightarrow or \leftarrow button to operate play quickly or slowly.
5. Press II button to make the program stop, and press again to resume it.
6. Press ZOOM button to make zoom, and press \leftarrow or \rightarrow or \uparrow or \downarrow button to enjoy the detail.
7. Press HELP button to call up or exit the OSD information. And press HELP button to call up or exit the OSD during operating file copy.
8. Press RETURN button to return to previous menu and stop play, press RETURN button repeatedly to return to main menu.

Stream media broadcast system

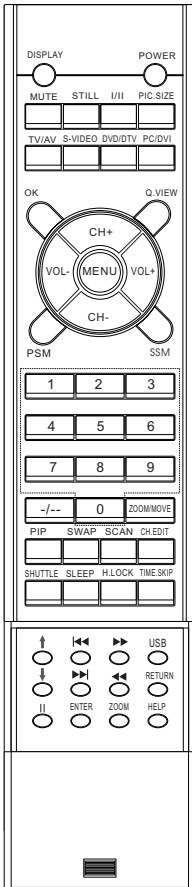

Note:

1. the play file menu are different with your USB devices.
2. May carry on the programming playing: repeated step 2 to choose many documents, (right key choice or cancellation picture choice), press ENTER to play, at this time, the picture of play will be the picture be choosed.

To select stream media broadcast system

1. Press ↑ or ↓ button to select DEVICE item.
(The device be inserted and identified).
2. Press ENTER button to enter adjusted option.

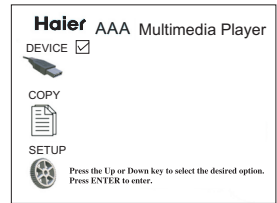

To play picture

- 1 Press ◀◀ or ▶▶ button to select Picture item.
- 2 Press ENTER button to enter the menu of play.
- 3 Press ↑ or ↓ button to select desired enjoy picture, and then press ENTER button to enter the play interface.

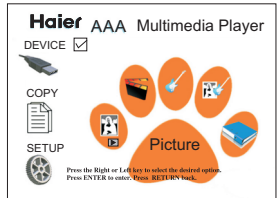

Note: you may play the pictures among selected.

- 4 During playing picture, Press HELP button to call up picture menu, at this time, you can operate the picture of playing.
- 5 Press ↑ or ↓ or ◀◀ or ▶▶ button to select the adjusted item, Press ENTER button to confirm.

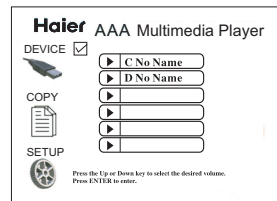

- ▶||: play or pause;
- : stop;
- : overturn;press ○ button to right turns over90
- ⊘: no available;
- ⊘: 12 pictures scan;
- 🖨️: print picture;
- ◀◀: play previous picture;
- ▶▶: play next picture;

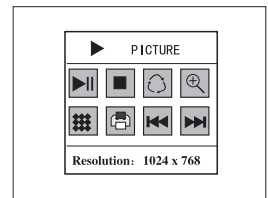
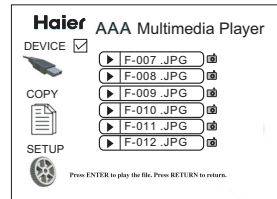

Note: The analysis rate basis picture itself clarity different and is different.

- 6 Press RETURN button to exit.

Stream media broadcast system

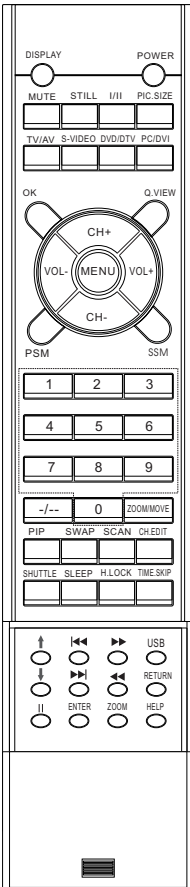

Note:
the play file menu are different with your USB devices.

Print Picture Setup

This machine has designed three printings pictures method.
(Single picture printing, Programming printing, 12 pictures browsing printing)

Single picture printing

- 1 Press **◀/▶** button to select Picture option, Press **ENTER** button to enter the submenu.
- 2 Press **↑/↓** button to select the picture to print, press **ENTER** button to enter playing menu.

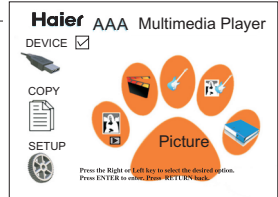

- 3 During scanning pictures, Press **||** button to select the picture, and then **↑/↓/◀/▶** button to select icon (📄), press **ENTER** button to print picture.

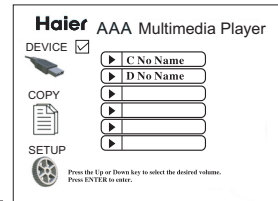

Programming printing

- 1 To enter picture file menu later, press **▶▶** button to selector cancel the file.
- 2 when you are satisfied with your choice, press **HELP** button to call up print menu, press **ENTER** button to confirm.

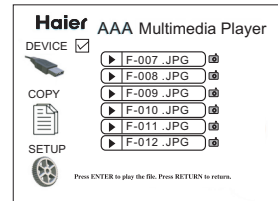

12 pictures browsing printing

1. press **↑/↓/◀/▶** button to select the icon (📄), press **ENTER** to enter.
2. Press **HELP** button to cancel the OSD, press **↑/↓/◀/▶** button to select the picture to print, press **ENTER** button to confirm, Press **HELP** button again to call up the OSD, press **↑/↓/◀/▶** to select the icon (📄), press **ENTER** button to print the picture.

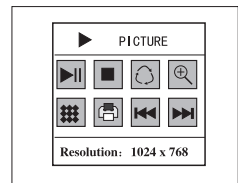

Note:

Selects the chart (▶▶), press **ENTER** button to scan next 12 pictures;
Selects the chart (◀◀), press **ENTER** button to scan previous 12 pictures;

Stream media broadcast system

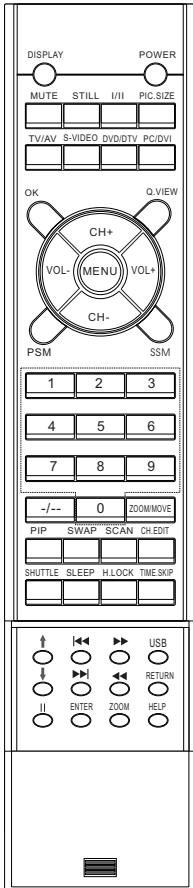

To play Movie

1 Press **◀◀** or **▶▶** button to select **Movie** option.

2 Press **ENTER** to enter playing menu.

3 Press again **↑** or **↓** button to select desired movie, and press again **ENTER** to enter the playing movie interface.

4 During playing movie, Press **HELP** button to call up picture menu, at this time, you can operate the movie of playing.

5 Press **↑** or **↓** or **◀◀** or **▶▶** button to select the adjusted item, Press **ENTER** button to confirm.

- ▶▶: play or pause;
- : stop;
- : no available;
- ⓧ: zoom
- ▶▶: quickly
- ◀◀: slowly
- ◀◀: play previous movie;
- ▶▶: play next movie;

Captions: According to movie document itself whether has the captions to decide

Audio channel: Mono, Stereo, Left, Right

Play Mode: Standard, Repeat All, Repeat File

6 Press **RETURN** button to exit.

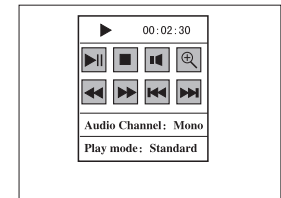
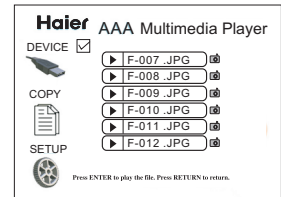
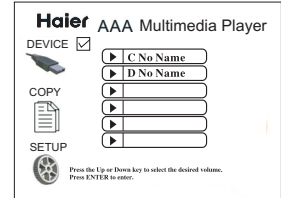
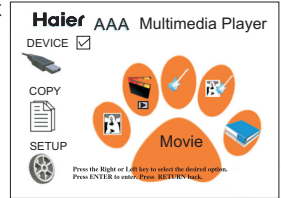

Stream media broadcast system

To enjoy music

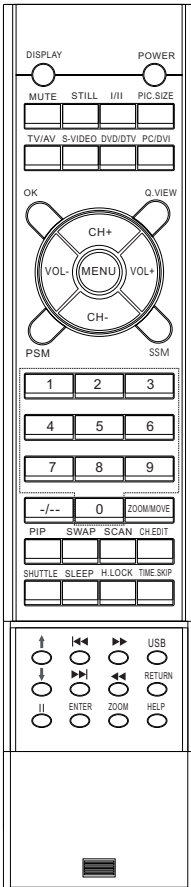

- 1 Press **◀◀** or **▶▶** button to select **Music** option.
- 2 Press **ENTER** button to enter play menu.
- 3 Press **↑** or **↓** button to select the desired music, and then press **ENTER** button to the playing music interface.

Note: the play file menu are different with your USB device.

- 4 When playing music, Press **↑** or **↓** or **◀◀** or **▶▶** button to select the adjusted item, Press **ENTER** button to confirm.

- ▶▶: play or pause;
- : stop;
- ⏸: No available
- ▼: Display or Close the OSD
- ▶▶▶: Quickly
- ◀◀◀: Slowly
- ◀◀: play previous music;
- ▶▶: play next music;

Play Mode: Standard, Repeat File, Repeat All

Press **↑** or **↓** button to select the desired mode, and then press **ENTER** button to confirm.

- 5 Press **RETURN** button to exit the playing.

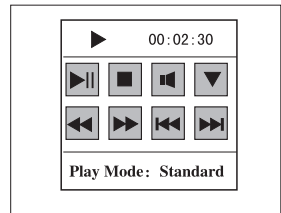
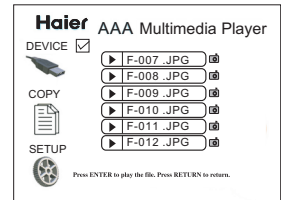
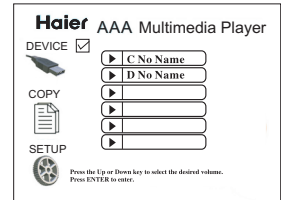
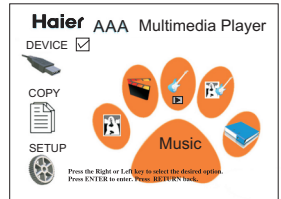

Stream media broadcast system

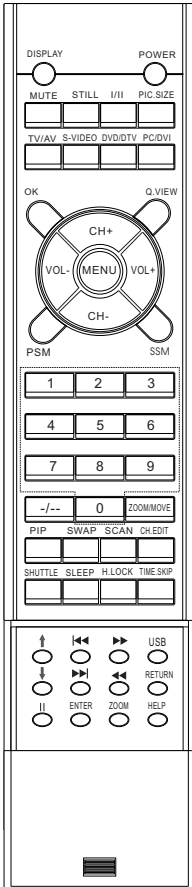

To select the Music and PIC item

1 Press **◀◀** or **▶▶** button to select **Music and Pic** option, and press **ENTER** button to enter play menu.

2 Press **↑** or **↓** to select desired file (picture and music), and press **ENTER** button to enter play menu.

3 During playing music, Press **HELP** button to call up picture menu, at this time, you can operate the movie of playing.

4 Press **↑** or **↓** or **◀◀** or **▶▶** button to select the adjusted item, Press **ENTER** button to confirm.

- ▶▶: play or pause;
- : stop;
- ⏪: No available
- ⏩: No available
- ⏮: No available
- ⏭: play previous music;
- ⏮: play next music;

5 Press repeatedly **RETURN** button to return.

Note: Under music and picture condition, because the system reads the time of picture more longer than reads the time of music, therefore in the broadcast process, the picture appears the time lag to the music, this belongs to the normal phenomenon.

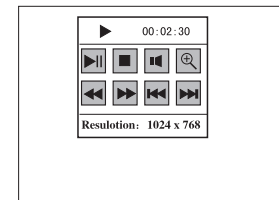
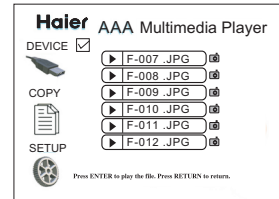
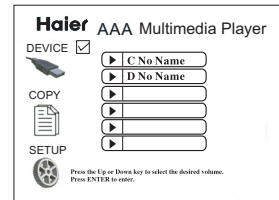
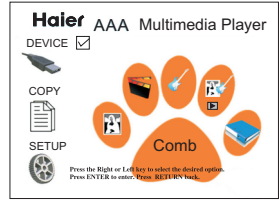

Stream media broadcast system

To select text

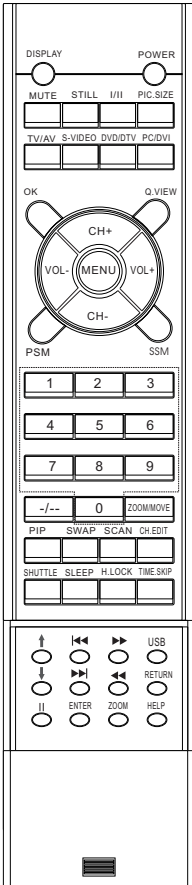

1 Press **◀** or **▶** button to select **text** option, and press **ENTER** button to enter text menu.

2 Press **↑** or **↓** to select desired text, and press **ENTER** button to confirm.

3 Press **↑** or **↓** or **◀** or **▶** button to watch the text.

4 Press repeatedly **RETURN** button to return.



Rolls reads the text



Previous page/next page.

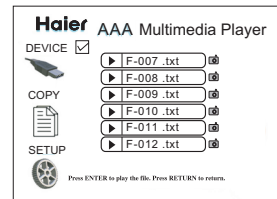
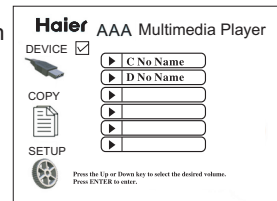
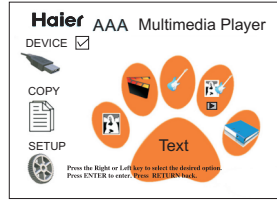

Stream media broadcast system

Copy file function

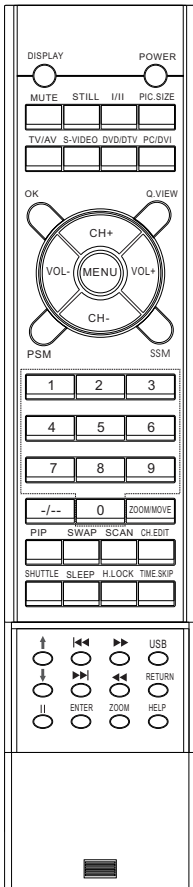

Note:
RIGHT button to select the all files;
LEFT button to cancel.

1 Press ↑ or ↓ to select **Copy** item.

2 Press ENTER button to enter the copy menu.

3 Press ↑ or ↓ button to select the desired item of copy.

4 Press HELP button to call up Copy, Paste and delete, and then press ↑ or ↓ button to select Copy, and press ENTER button to confirm.

5 To select a folder, then Press ENTER button to enter, and then press HELP button to call up Paste item, Press ENTER button to confirm.

6 If there are the same texts between the texts of paste, the “File already exist! Do you want Overwrite it?” will display on the screen, at this time, press ◀◀ or ▶▶ button to select the desired item, Press ENTER button to confirm.

7. Press ENTER to cancel.

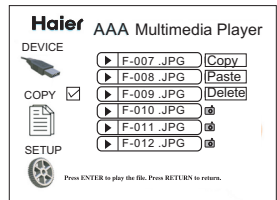
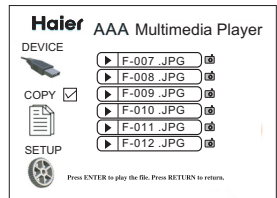
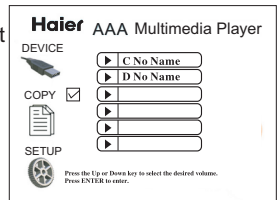
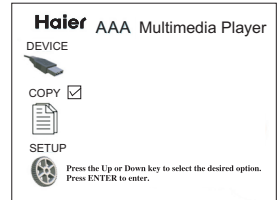

Stream media broadcast system

To select language

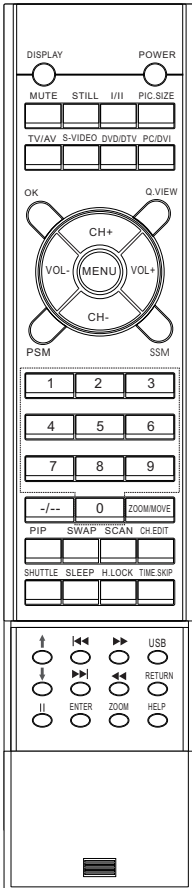

- 1 Press \uparrow or \downarrow to select **SETUP** item.
- 2 Press **ENTER** button to enter **SETUP** menu.
- 3 Press \uparrow or \downarrow to select **language** option, and then press **ENTER** button to enter the submenu.
- 4 Press \uparrow or \downarrow to select desired language, and press **ENTER** to ensure it.
- 5 Press **RETURN** button to return.

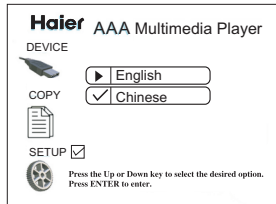
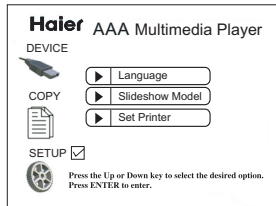
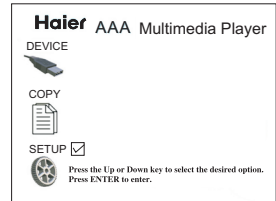

Slideshow Model

- 1 After entering the **SETUP** menu.
- 2 Press \uparrow or \downarrow to select **Slideshow Model** option, and then press **ENTER** button to enter the submenu.
- 3 Press \uparrow or \downarrow to select desired mode, and press **ENTER** to ensure it.
- 4 Press **RETURN** button to return.
 - **Fine Model**
Picture clarity high, the browsing speed is slow.
 - **Normal Model**
Picture clarity normal, the browsing speed is quick

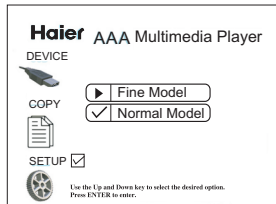

Stream media broadcast system

Set Printer

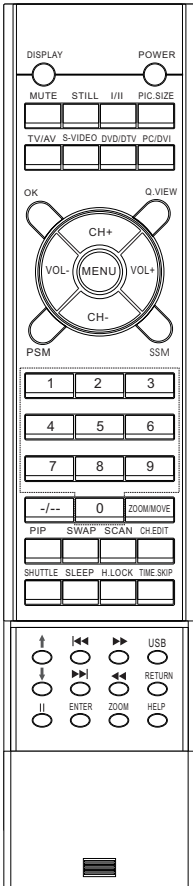

- 1 Press \uparrow or \downarrow to select **SETUP** item.
- 2 Press **ENTER** button to enter **SETUP** menu.
- 3 Press \uparrow or \downarrow to select **Set Printer** option, and then press **ENTER** button to enter the submenu.
- 4 Press \uparrow or \downarrow to select desired language, and press **ENTER** to ensure it.
- 5 Press **RETURN** button to return.

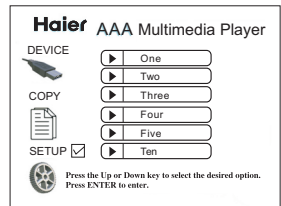
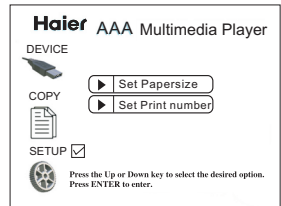
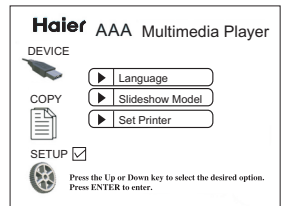
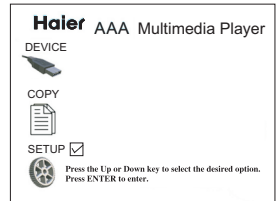

Maintenance

- Early malfunctions can be prevented. Careful and regular cleaning can extend the amount of time you will have your new TV. Be sure to turn the power off and unplug the power cord before you begin any cleaning.

Cleaning the Screen

1. Here's a great way to keep the dust off your screen for a while. Wet a soft cloth in a mixture of lukewarm water and a little fabric softener or dish washing detergent. Wring the cloth until it's almost dry, and then use it to wipe the screen.
2. Make sure the excess water is off the screen, and then let it air-dry before you turn on your TV.

Cleaning the Cabinet

To remove dirt or dust, wipe the cabinet with a soft, dry, lint-free cloth. Please be sure not to use a wet cloth.

Extended Absence

If you expect to leave your TV dormant for a long time (such as a vacation), it's a good idea to unplug the power cord to protect against possible damage from lightning or power surges.

Troubleshooting

For the sake of time and cost, it is strongly recommended that you check out the problem by yourself according to the instructions listed hereunder before contacting the after-sales service for technical assistance.

Problem	Possible remedies
No picture, no sound	Turn on the power supply; Properly plug the TV set to the power socket; Check to see if the power cable of other appliance is plugged in the TV set. Make sure that the power cable of the TV set is properly connected.
Good picture, no sound	Depress the volume button; Check out the audio frequency inputs signals.
Failure of remote controller	Check to see if the remote controller display receiving window are blocked by other objects and if batteries are properly loaded.
No color, weak color or poor picture	Designate the item of color from the Picture menu and depress the volume button; Keep the display and VCR separate a reasonable space; Activate some functions to store picture brightness; Make sure that the display and signal source are available and turned on.
Excessive brightness or darkness	Adjust brightness or contrast.
Picture too big or small	Adjust the setup of sizes.
One speaker failure	Balance the sound in the menu.
Slight sound from display	It is a normal phenomenon.

Note: Do not leave the television with static picture in an extended period as it may result in residual image on your television screen.

Note: Production of the screen requires high and precision technologies. However, there might be some dark or bright (red, blue or green) spots, or some anomalistic stripes or spots. This is not defect. If the TV set is used in an area 2,400 meters above the sea level where the air pressure is below 750hpa, the picture on the screen may be affected and a muffled sound might be produced. These phenomena might happen in the area 1,500 meters above the sea level. This is resulted from difference between air pressures inside and outside the display. This is not a defect covered by the limited warranty.

Specifications

Basic specification and parameter

Model	P50A11-AK	P60A11-AK
Power	~ 150-240V 50Hz	
Power Consumption	≤450W	≤650W
Color System	PAL, NTSC, SECAM	
Sound System	D/K, I, B/G, M	
Video input	AV (CVBS) , S-VIDEO, YPbPr/YCbCr, HDMI or DVI, VGA	
Environmental condition	<p>Operating temperature range: 5°C ~ +35°C Operating humidity range: 20%-80% Storage Temperature: -15°C ~ +45°C Storage Humidity: 5%-90%, non-condensing</p> <p>If the storage temperature is lower than 0 °C, please first lays the machine aside after in the operating temperature environment carries on restores 2 hours, then electrifies the use again, protects your television not to receive the damage.</p>	
Accessories	<p>Use's manual X1 Remote Control x1 Maintenance card x1 Power cable x1 Alkaline x2</p>	

Product main size (does not contain stand & speaker)

Model	Net Size(L x W xH)	Net Weight
P50A11-AK	1240x398x893mm(stand included)	49Kg
P60A11-AK	1454x398x1012mm(stand included)	63Kg

NOTE

*Design and specifications are subject to change without notice.
 The dimension in this manual is a approximation.*

Format

Recommendatory HDTV/SDTV(YPbPr/YCbCr) format:

Sequence Number	Format	Refresh Frequency (Hz)
1	480i/480p	60
2	576i/576p	50
3	720p	50/60
4	1080i/1080p	50/60

Recommendation PC connection input format:

sequence number	Format	H-Frequency (KHz)	V-Frequency (Hz)
1	640*480@60Hz	31.5	60
2	800*600@60Hz	37.88	60
3	1024*768@60Hz (Recommendatory)	48.36	60
4	1280*1024@60Hz	63.9	60
5	1600*1200@60Hz	75	60

Recommendation DVI connection input format:

Sequence Number	Resolution	Refresh Frequency (Hz)
1	640*480	60
2	800*600	60
3	1024*768	60
4	1280*1024	60

Recommendation HDMI connection input format:

Sequence Number	Format	Refresh Frequency (Hz)
1	480i/480p	60
2	576i/576p	50
3	720p	50/60
4	1080i	50/60

Haier



01
0090500960

Free Manuals Download Website

<http://myh66.com>

<http://usermanuals.us>

<http://www.somanuals.com>

<http://www.4manuals.cc>

<http://www.manual-lib.com>

<http://www.404manual.com>

<http://www.luxmanual.com>

<http://aubethermostatmanual.com>

Golf course search by state

<http://golfingnear.com>

Email search by domain

<http://emailbydomain.com>

Auto manuals search

<http://auto.somanuals.com>

TV manuals search

<http://tv.somanuals.com>