

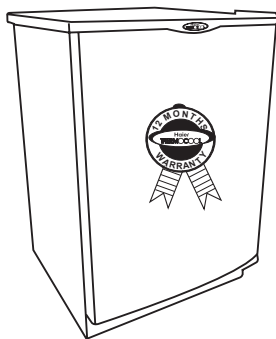

HF-116R

Freezer

Owner's Manual



IMPORTANT: Congratulations for choosing a high quality refrigerator by Haier **THERMOCOOL**. Please read this owner's manual carefully before using your new refrigerator. Now you will be cool, with Haier **THERMOCOOL**.

Parts

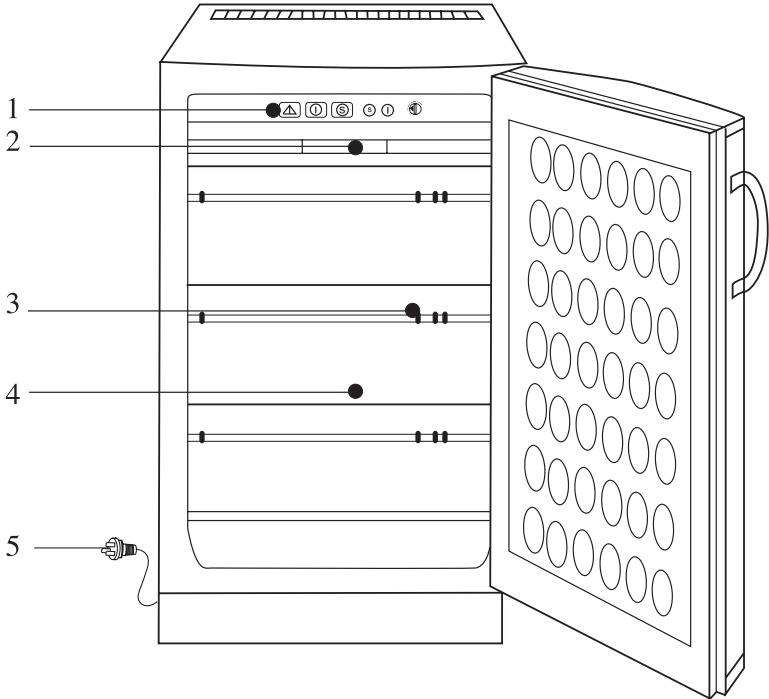

Parts

- 1 Control panel
- 2 Freezer tray
- 3 Slider
- 4 Drawer
- 5 Plug

The manufacturer reserves the right to improve the product from time to time without further notice.

Cautions

Disposal of the old appliance

Before disposing an old appliance, please make sure it's inoperative and safe. Unplug the appliance and remove or destroy all of the springs, latches, or bolt-locks in order to avoid the risk of child entrapment.

It must be noted that the refrigeration system contains insulating gases and refrigerants, which require specialized waste disposal. The valuable materials contained in a refrigerator can be recycled. Contact your local waste disposal center for proper disposal of an old appliance and contact your local authority or your dealer if you have any question. Please ensure that the pipework of your refrigerator does not get damaged prior to being picked up by the relevant waste disposal center, and contribute to environmental awareness by insisting on an appropriate, anti-pollution method of disposal.

Disposal of the packaging of your new appliance

All the packaging materials employed in the package of your new appliance may be disposed without any danger to the environment.

The cardboard box may be broken or cut into smaller pieces and given to a waste paper disposal service. The wrapping foil is made of polyethylene and the polyethylene pads and stuffing contain no fluorochloric hydrocarbon.

All these valuable materials may be taken to a waste collecting center and used again after adequate recycling.

Consult your local authorities for the name and address of the waste materials collecting centers and waste paper disposal services nearest to your house.

Safety Instructions and Warnings

Before starting the appliance, read the information given in the User's Guide carefully. The User's Guide contains very important observations relating to the assembly, operation and maintenance of the appliance.

Keep the User's Guide in a safe place and remember to hand it over to the subsequent owner, if you ever sell the appliance.

The manufacturer does not accept responsibility for any damages that may arise due to non-observation of the following instruction.

- Damaged appliances are not to be put into operation. In case of doubt, consult your supplier.
- Connection and installation of the appliance are to be carried out in strict compliance with the relative instructions set forth in the User's Guide.

Cautions

- For the purpose of safety, the appliance must be properly earthed in accordance with specifications.

- Always remember to unplug the appliance before cleaning. To disconnect the appliance, pull at the plug itself not the cord.

- All electrical repairs must be carried out by qualified electricians. Inadequate repairs may result in a major source of danger for the user of the appliance.

- Keep alcoholic beverages in airtight bottles or containers and always store in an upright position. In addition, do not store any explosive substances inside the appliance-
Danger of explosion!

- Do not damage any parts of the appliance that carry refrigerant by piercing or perforating the refrigerant's grooves with sharp or pointed items, crushing or twisting any tubes, or scraping the coatings off the surfaces. If the refrigerant spurts out and gets into eyes, it may result in serious eye injuries.

- Do not obstruct or cover the ventilation grille of the appliance.

- Do not allow children to play with the appliance. In no case should children be allowed to sit on the drawers or hang onto the door.

If the supply cord is damaged, it must be replaced by the manufacturer or its service agent or a similarly qualified person in order to avoid a hazard.

Specifications

- This appliance is designed for frozen food storage.

- It is intended strictly for household use. If using it for industrial or commercial purpose, be sure to observe the relevant norms and regulations.

- The refrigerating circuit is leak-proof.

- Never store anything dangerous in the appliance, such as combustibles, explosives, strong acid and alkali. etc.

- The appliance is not intended for use by young children or infirm persons without supervision.

- Young children should be supervised to ensure that they do not play with the appliance.

WARNING:

The plug should be accessible after the appliance positioned.

Installation

- The appliance must stand on even flooring. If the refrigerator is not level, adjust the front leveling leg to raise or lower it.

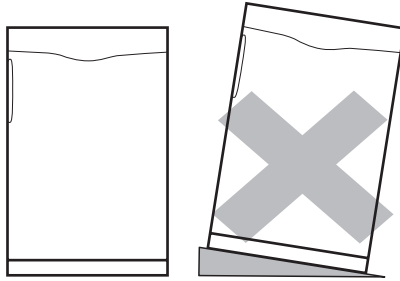

- Install the appliance in a well-ventilated room. Allow 10cm on each side and 10cm over the top of the refrigerator for easy installation and proper air circulation.

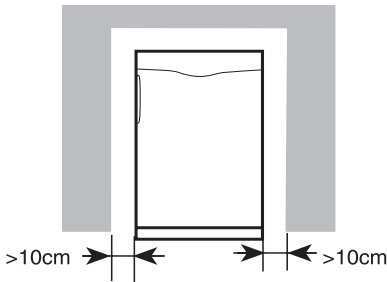

- Do not expose the appliance to direct sunlight or a heat source as cooker.

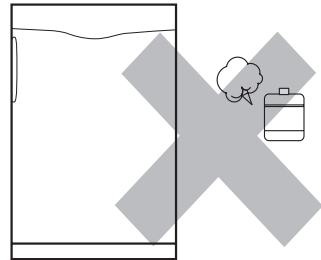

- An extremely cold room is unsuitable for installation of the appliance.

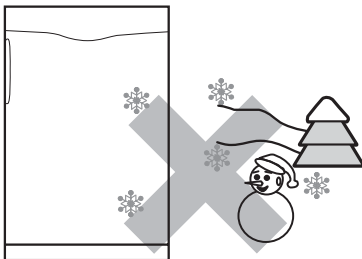

- To prevent electric shock, do not expose the appliance to rain or moisture.



Basic Operation

Please clean inner compartment of the appliance thoroughly before the initial start-up. After the appliance is levelled and cleaned, allow it to stand still for 30 minutes before start-up.

1. Start-up

- Start the appliance at least 4 hours before storing foods in it for the first time.
- Plug in the appliance and the green power indicator (2) and red warning indicator (3) light.
- The red warning indicator goes out after the inner temperature is as low as the set one.

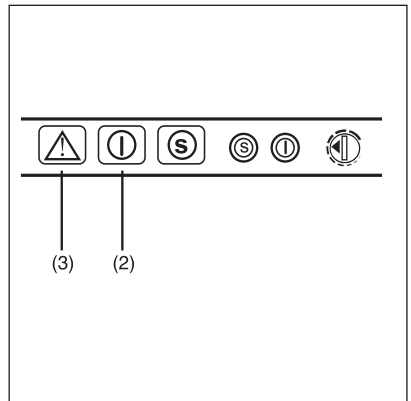
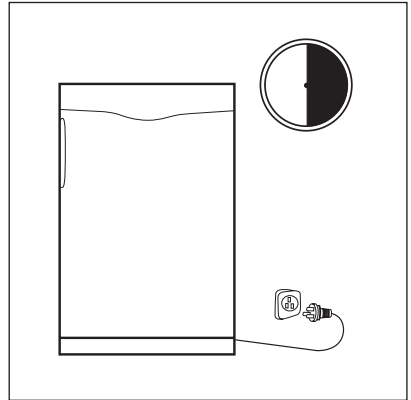

2. Temperature selection

Use the temperature regulator to adjust the inner temperature. Adjust the inner temperature as desired with a coin. To turn the temperature regulator clockwise, the inner temperature falls accordingly.

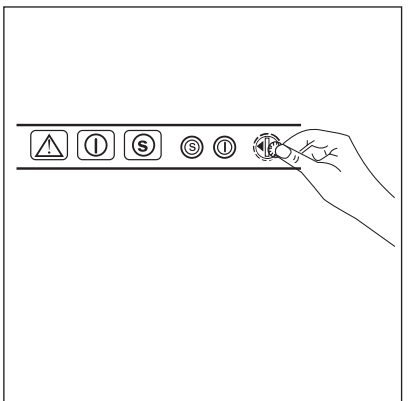

Basic Operation

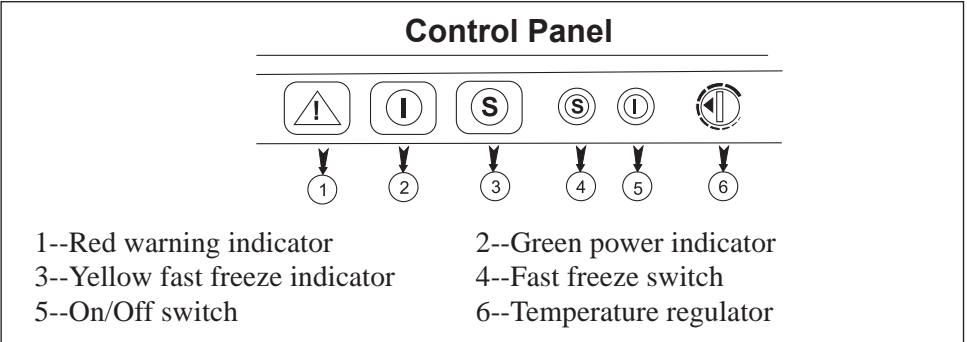

Green power indicator (2)

After the appliance is plugged in, the green power indicator lights. If the green power indicator doesn't work, check whether the light bulb is broken. The bulb is broken if the compressor works normally. Otherwise, please check:

△ Whether the appliance is turned on

△ Whether the plug connection is loose or the fuse is broken

For problems that could not be settled by yourself, contact a qualified electrician.

Yellow fast freeze indicator (3)

Push the yellow fast freeze button (4) and the yellow fast freeze indicator lights. The fast freeze system starts. Push the button again and the yellow fast freeze indicator goes out. The fast freeze system is turned off.

Red warning indicator (1)

△ The red warning indicator lights when the inner compartment is not cold enough.

△ The red warning indicator always lights when the appliance is started for the first time.

△ The red warning indicator lights when a lot of fresh foods are stored in the appliance.

△ The red warning indicator lights when the temperature regulator is adjusted to a setting of lower temperature.

△ After the inner temperature falls off to a certain degree, the red indicator goes out.

△ If the red indicator lights irregularly, check if the appliance door is well closed, if fresh foods are just stored in the appliance, or if there is a long power failure before that. If not, contact the nearest service center.

Operation Instructions

Use the freezer for long-time food storage

The inner temperature of the freezer is lower than -18°C . Bacteria reproduction is completely suppressed under such circumstance. Therefore, the freezer is suitable for long-time food storage, provided that the expiry date on the food package is observed.

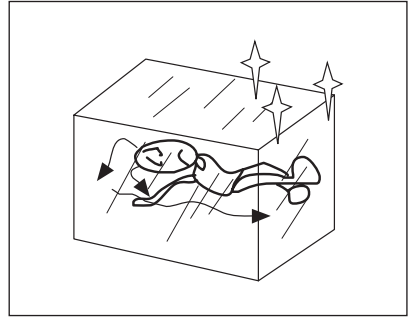

Fast freeze

To preserve the nutrition, taste and shape, use the fast freeze function to freeze the food in the shortest time.

- Start the fast freeze system at least 6 hours before placing fresh foods into the freezer. Push the fast freeze button (4), and the fast freeze indicator (3) lights. (For the amount less than 10% of the freeze capacity, it's unnecessary to start the fast freeze system.)
- Place the foods to be frozen into different drawers if possible.
- The foods will be frozen thoroughly in 24 hours. Press the fast freeze button (4) again to switch off the fast freeze system. The yellow indicator (3) goes out.

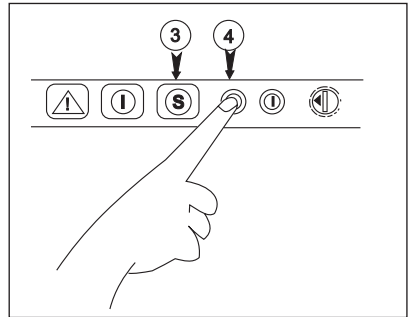

Tips for freezing

- The amount of food to be frozen at one time should not exceed the freeze capacity (10kg/24h) of the freezer.

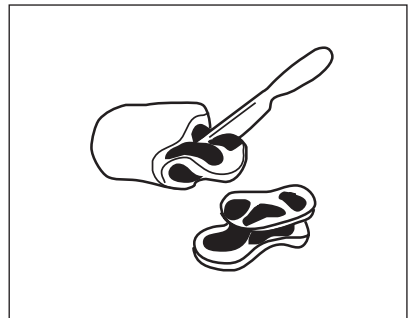

Operation Instructions

- Allow warm food or beverage to cool down before placing them inside the appliance.

- Divide a large amount into smaller pieces that are easy to be frozen thoroughly, so that the quality of food is best preserved. For fruits, the amount should be less than 1kg, and for meat, 2.5kg.

- Wrap or cover foods well before storing them into the freezer. The packing material must be durable, odorless, impermeable and not breathable so as to keep the foods in good condition. Label on the package the expiry date for reference.

- It's advisable to take out the necessary amount of food only. Don't refreeze foods that have been thawed completely. Cook the thawed foods before refreezing them.

- Do not store bottles of beverages inside the appliance.

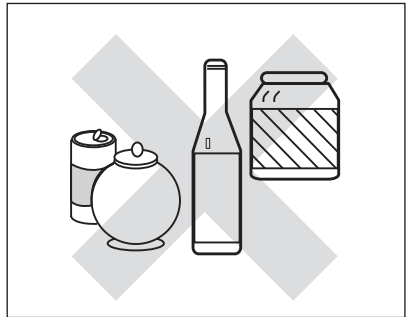
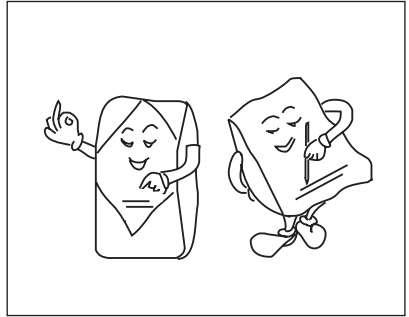

How to take out the drawer

The drawers can be removed from the appliance when it's loaded or unloaded with food. To remove it, pull the drawer forwards and twist out sideways.

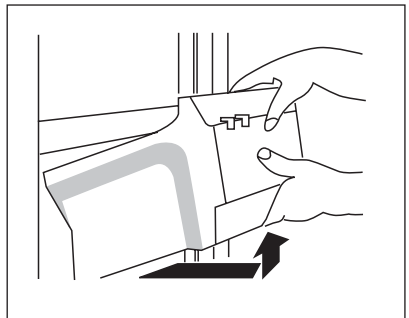

Operation Instructions

Freezer tray

The special tray for soft fruit and berries allows you to individually freeze your berries prior to bagging for perfect results.

How to use the slider

The freezer drawers are printed with illustration of foods and figures that represent months. Push slider '1' under the food symbol, and slider '2' of the same color under the month figure.

For example:

The quality period of sausage is 4 months. Placed in the freezer in January, the sausage may be stored until May. Push slider '1' under the symbol of sausage and slider '2' of the same color under the figure 5, for reference.

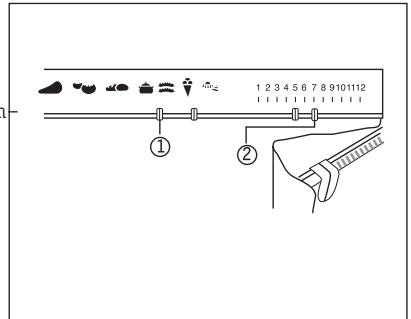
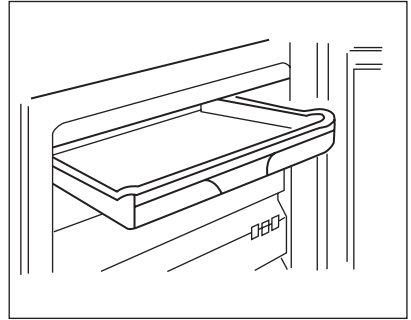

Making ice

Fill 3/4 of the ice tray with water and place it in the freezer compartment. To remove the ice cube, twist the ice tray gently or has it stay in running water for a while.

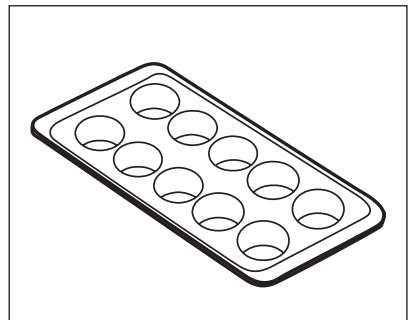

Defrosting/Cleaning

Defrosting

The freezer compartment does not automatically defrost. A thick layer of frost or ice will increase energy consumption. When the frost layer is thick as 4-6mm, it should be removed with a plastic scraper.

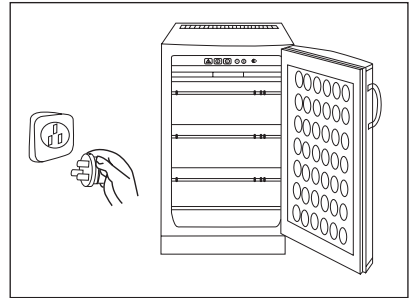

**Never use a metallic tool to defrost-
Danger of damaging the appliance.**

Unplug the appliance before defrosting. Remove the foods from the freezer compartment. Wrap foods in several layers of newspapers and store in a cold place. To speed up the defrosting process, you may place a saucepan with warm water inside the freezer.

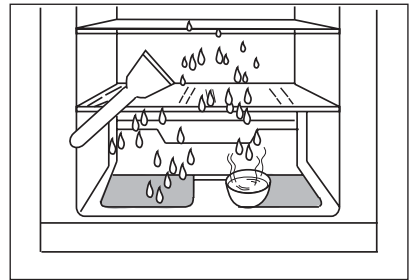

Never use an electric heater to defrost.

At power failure

Even in summer, power failure that lasts for several hours doesn't affect the frozen food in the appliance. If a power failure is announced.

- Turn on the fast freeze system so as to make the foods as cold as possible.
- Do not place any fresh food in the freezer at the power failure. Keep the door closed during power failure if possible.

Note

A continued power failure will have adverse effect on the storage period and the food quality.

Defrosting/Cleaning

Cleaning

- Unplug the appliance before cleaning.
- Wash the inner compartment with lukewarm water and neutral detergent. Rinse and dry with a cloth or sponge. Do not use cleansers such as soaps, paint, boiled water or acid, etc.
- Dry the surface of the refrigerator thoroughly.
 - (1) Avoid splashing water on the freezer when cleaning.
 - (2) Make sure that water doesn't get into electric components such as temperature regulator.
- To clean the door seal, use only mild, soapy water.
- For efficient operation, dirt and dust should be removed from back and bottom of your freezer from time to time.

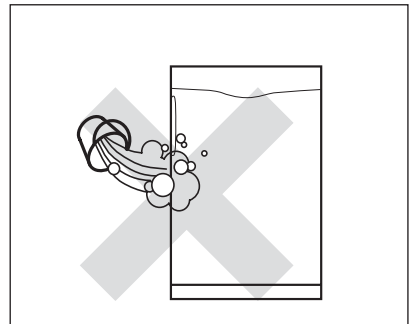
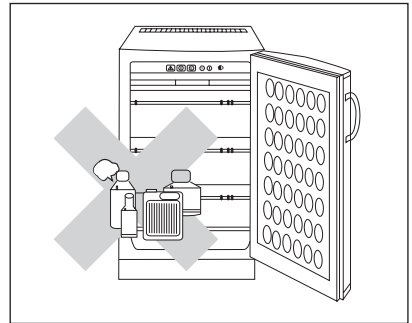
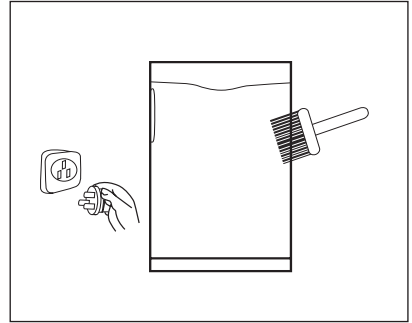

When not in use

- If your freezer will not be used for a period of time, turn the unit off and unplug. Clean the freezer as described above.
- Leave the door open.

Note: Do not stop the appliance frequently otherwise the service life of the appliance may be shortened.

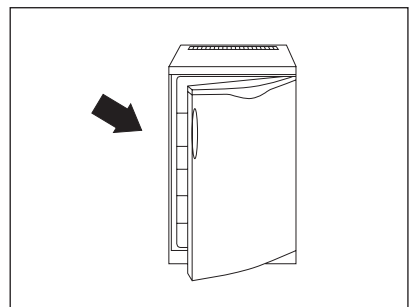

Troubleshooting

Before calling the service center, check the following points and see if you can solve the problem yourself.

Problem	Possible cause
The freezer doesn't work.	<ul style="list-style-type: none">● Not plugged in.● Voltage is too low.
The indicator doesn't work.	<ul style="list-style-type: none">● Not plugged in.● The light bulbs are broken.
Unusual noise	<ul style="list-style-type: none">● The appliance doesn't stand level.● The appliance is placed so near the wall that some part of it rubs against the wall.
The compressor works all the time.	<ul style="list-style-type: none">● A Large amount of foods are placed in the appliance.● Initial start-up● The door is opened frequently.● The temperature regulator is not properly set.● The appliance is exposed to direct sunlight or a heating vent.● Poor ventilation. The ventilating grille is blocked or the condensor needs to be cleaned.
Unpleasant odor	<ul style="list-style-type: none">● Foods with strong odors are not tightly covered.● Interior needs to be cleaned.

HF-116R WIRING DIAGRAM

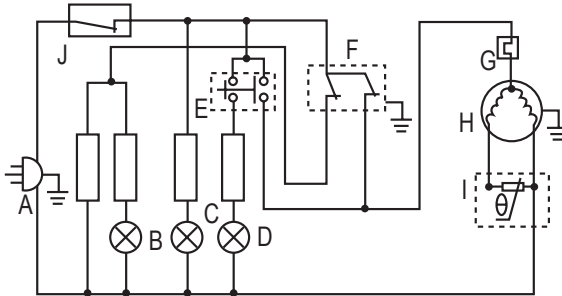

- | | |
|-------------------------|---------------|
| A-POWER PLUG | B-RED LAMP |
| C-GREEN LAMP | D-YELLOW LAMP |
| E-QUICK FREEZING SWITCH | F-THERMOSTAT |
| G-OVERLOAD PROTECTOR | H-COMPRESSOR |
| I-PTC | J-MAIN SWITCH |

Troubleshooting

MODEL	HF-116R
12Month's Guarantee	YES
Capacity	120Ltr.
Voltage	220-240V, 50Hz
Total Input Power	120W
Energy Consumption	1.1 kw-h / 24h
Refrigerant	R134a 92g
Size (WxDxH in mm)	550x623x850
Net Weight	45kg
Automatic Interior Light	NO
Lock	NO
Adjustable Feet	YES
Adjustable thermostat	YES
Drain Facility	NO
<p>Note: All capacities are gross. Haier THERMOCOOL reserves the right to change specifications as part of its policy of continuous improvement.</p>	



Haier THERMOCOOL produce high quality refrigerators which are strong, reliable, elegantly styled-yet practical and long lasting for the most demanding tropical climate and conditions.

Haier THERMOCOOL new generation refrigerators are convenient to use, highly efficient, energy saving and are built for quiet running to withstand voltage fluctuations.

Unique **Haier THERMOCOOL** 12 MONTH GUARANTEE gives you peace of mind and assured satisfaction from the moment of purchase. The 12 MONTH GUARANTEE covers:

- Free part replacement under warranty
- Free repair under warranty

Unique **Haier THERMOCOOL** NATIONWIDE SALES and SERVICE NETWORK offers you fast, reliable service and replacement spare parts which will normally be available for many years. Sales & Service is available in ILUPEJU, IBADAN, BENIN, WARRI, PORT HARCOURT, ABA, ENUGU, ONITSHA, KADUNA, ZARIA, KANO, JOS, MAIDUGURI, MINNA, ABUJA. Contact HPZ or your local **Haier THERMOCOOL** distributor for information.

...part of your life

Haier THERMOCOOL reserves the right to amend specifications without notice as part of its continuous improvement programme. **Haier THERMOCOOL** is a registered trademark.



45/57, Town Planning Way, Ilupeju Industrial Estate,
P.M.B 21132, Ikeja, Lagos, Nigeria. Tel: 01-4973474, 01-5554768,
01-5553288-90, Fax: 01-5553289, 01-4962076, E-mail: sales@hpz.com.ng
www.htcool.com

VC532007



Free Manuals Download Website

<http://myh66.com>

<http://usermanuals.us>

<http://www.somanuals.com>

<http://www.4manuals.cc>

<http://www.manual-lib.com>

<http://www.404manual.com>

<http://www.luxmanual.com>

<http://aubethermostatmanual.com>

Golf course search by state

<http://golfingnear.com>

Email search by domain

<http://emailbydomain.com>

Auto manuals search

<http://auto.somanuals.com>

TV manuals search

<http://tv.somanuals.com>