

Haier

HFZ-85

FREEZER



USER'S INSTRUCTIONS

Download from [Www.Somanuals.com](http://www.Somanuals.com). All Manuals Search And Download.

Thank you for your purchase of this Freezer. This instruction manual explains the features and functions of the device. There is a trouble shooting section towards the end of the manual which should be referred to in case of any unexpected device behaviour.

Guide to use the instruction book

The following Symbols will be found in the text to guide you through the instructions



Safety Instructions



Hints and Tips



**Step by step instructions
for operation**



Environmental Information



IMPORTANT SAFETY INSTRUCTIONS

These warnings are provided in the interests of your safety. Ensure that you have read and understood them all before installing or using the appliance.

If you are unsure about any of these warnings, contact Customer Support for assistance.

Installation

- This appliance is heavy. Care should be taken when moving it.
- It is dangerous to alter the specifications or attempt to modify this product in any way.
- Ensure that the appliance does not stand on the electrical supply cable. If the supply cord is damaged, it must be replaced by a special cord available from your Local Service Centre.
- Any electrical work required to install this appliance should be carried out by a qualified electrician or competent person.
- Whenever possible, the back of the appliance should be close to a wall but leaving the required distance for ventilation as stated in the installation instructions.
- The appliance should be left to stand for 2 hours after installation before it is turned on, in order to allow the refrigerant to settle.

Child Safety

- Do not allow children to tamper with the controls or play with the product.

During Use

- This appliance is designed for domestic use only, specifically for the storage of edible foodstuffs only.
- Frozen food should not be refrozen once it has thawed out.
- Do not place carbonated or fizzy drinks in the freezer.
- Ice lollies can cause 'frost/freezer burns' if consumed straight from the freezer
- Do not remove items from the freezer if your hands are damp/wet, as this could cause skin abrasions or frost/freezer burns.

Maintenance and Cleaning

- Switch off, and unplug the appliance before carrying out any cleaning or maintenance work.
- Do not use sharp instruments to scrape off frost or ice. (See defrosting instructions on page 8).

Servicing

- This product should be serviced by an authorised service agent, and only genuine spare parts should be used.
- Under no circumstances should you attempt to repair the machine yourself. Repairs carried out by inexperienced persons may cause injury or serious malfunction.

At the End of the Appliance Life

- When disposing of your appliance, use an authorised disposal site.
- Remove the plug and ensure that any locks or catches are removed, to prevent young children being trapped inside.



Read through this instruction book carefully before use and retain for future reference.

TABLE OF CONTENTS

For the User

For the Installer

Important Safety Instructions	2	Door Reversal	10
Description of the Appliance	4	Installation Requirements	11
Using Your Appliance	5	Ventilation Requirements	11
Before Use	5	Levelling	11
Thermostat Controls	5		
To Start The Appliance	5		
The Freezer Compartment	6		
Freezing Fresh Food	6		
Frozen Food Storage	6		
Hints and Tips	7		
Normal Operating Sounds	7		
Food Storage	7		
Energy Saving Advice	7		
In the Event of a Power Failure	7		
Maintenance and Cleaning	8		
Internal Cleaning	8		
External Cleaning	8		
To Defrost the Freezer	8		
When the Appliance is Not in Use	8		
Troubleshooting	9		

Description of the Appliance

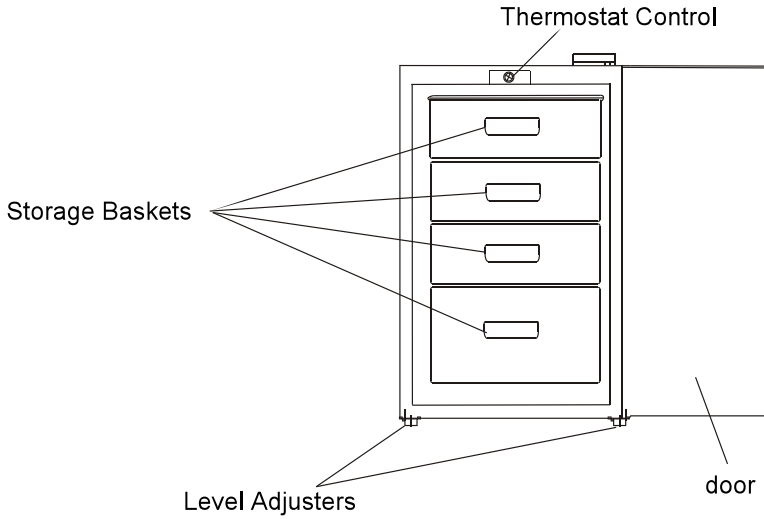

Thermostat Control

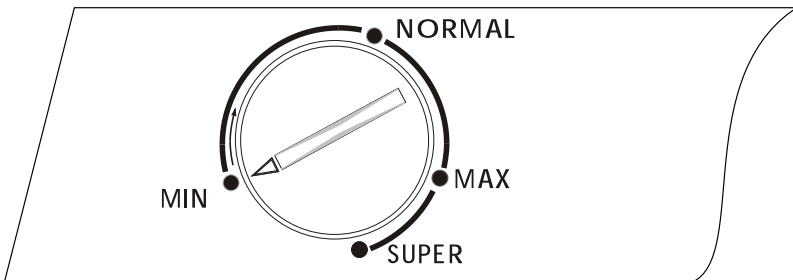

USING THE APPLIANCE

 *This appliance is designed for domestic use only, specifically for the storage of edible food stuffs.*

This appliance is designed to operate in ambient temperatures (surrounding air temperature) between 16°C and 32°C.

Outside this temperature range, the freezer may not operate correctly. Should the ambient temperatures be exceeded for long periods, the temperature in the freezer section will be above -18°C and food spoilage may occur.

Before Use

Remove all securing tapes.
Wash the inside of the appliance with lukewarm water with a little bicarbonate of soda added (5ml to 0.5 litre of water). Do not use soap or detergent as the smell may linger.
Dry the appliance thoroughly.

Thermostat Control

The thermostat control situated in the control panel regulates the temperature of the freezer compartment.

Position "Min" - Cold

Position "Normal" - Colder. This setting is generally most suitable for everyday use.

Position "Max" - Coldest

Position "Super" - To fast freeze a quantity of unfrozen food, the compressor works continuously in this mode.

See "Freezing Fresh Food" on page 6 for details. The temperature will be affected by:

- Room temperature
- How often the door is opened
- How much food is stored
- Position of the appliance

In determining the correct temperature control setting for your situation, all these factors have to be considered, and some experimentation may be necessary.

 *Do not allow children to tamper with the controls or play with the product.*

 *Do not use detergents, abrasive powders, highly perfumed cleaning products, wax polishes or products containing alcohol.*

To Start the Appliance

1. Allow the appliance to stand for 2 hours after installation.
2. Plug in the appliance and switch on at the mains supply.
3. Turn the thermostat control to the required setting. A mid way setting is usually suitable for normal operation (see thermostat control).
4. Leave the appliance for approximately 4 hours for the correct temperature to be reached before placing food inside.

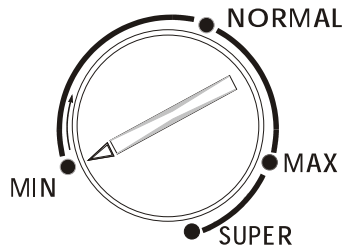

The Freezer Compartment

The  symbol means that your freezer will store frozen food at -18°C (-0.4°F) or colder, allowing for long term frozen food storage and freezing of fresh food. The freezer temperature is controlled automatically by the thermostat situated in the control panel. Due to the different installations, methods of usage and weather conditions, adjustments to the temperature settings may be required.

 These are best assessed against a temperature reading on a thermometer buried in the frozen food. The reading must be taken quickly as the thermometer temperature will rise rapidly after removal.

Freezing Fresh Food

A maximum of 4 kilograms of food can be frozen in 24 hours, using the "Super" mode on the Thermostat Control.

During the freezing process, the temperature of fresh food must be reduced quickly so that ice crystals are kept as small as possible. If the freezing process takes place slowly, large ice crystals will form and the food quality will be affected.

Food packets to be frozen should be placed in contact with the baskets surface, and should be spaced apart to allow circulation of cold air. The food to be frozen should not touch the existing frozen contents. If necessary, removing one of the higher baskets will allow storage of larger items.

No harm will result if you forget to turn of the fast freeze switch after 24 hours, but for reasons of economy, try to remember to turn it off when the freezing process is complete.

 *Frozen food should not be refrozen once it has thawed out.*

Do not remove items from the freezer if your hands are damp/wet, as this could cause skin abrasions or 'frost/freezer burns'.

For safety reasons, the freezer baskets are fitted with stops but are readily removed by pulling them forward to the stop, then lifting the front and pulling all the way out. Re-fit by reversing this procedure.

Frozen Food Storage

The appliance has the following net storage volume: 80 litres.

This is a standard measurement and the actual capacity depends upon the density and sizes of the food. The above figures are based on an average density of 0.32kg per litre.

Pre packed commercially frozen food should be stored in accordance with the manufacture's instructions and should be put in the freezer as soon as possible after purchase. Your freezer provides for long term storage which generally means up to 3 months but the length of the time can vary and it is important to follow the recommended times shown on packets of commercially frozen food.



Do not place sealed containers or carbonated liquids such as fizzy drinks into the freezer as it creates pressure on the container which may cause it to explode, resulting in damage to the freezer.

Ice cubes and ice lollies should not be consumed immediately after removal from the freezer as it may result in low temperature skin abrasions.

Manufacturers' storage time limits should be adhered to.



Hints and Tips

- Any opened packets of frozen food should be rewrapped in airtight materials to prevent surface evaporation, which causes drying or 'freezer burn'.
- Frozen food that has accidentally thawed should either be used immediately or thrown away.
- Alternatively if the food is uncooked and has not been completely defrosted, it can be cooked and then refrozen.
- Aim to check dates on packets and rotate food regularly.



HINTS AND TIPS

Normal Operating Sounds

- You may hear faint gurgling or bubbling sounds when the refrigerant is pumped through the coils or tubing at the rear, to the cooling plate/evaporator or the fixed freezer baskets.
- When the compressor is on, the refrigerant is being pumped around, and you will hear a whirring sound or pulsating noise from the compressor.
- A thermostat controls the compressor, and you will hear a faint 'click' when the thermostat cuts in and out.

Food Storage

- To obtain the best results from your appliance, neither hot foods nor liquids which may evaporate, should be placed in the freezer compartment.
- Avoid buying frozen food if you cannot store it straight away. The use of an insulated container is advisable. When you arrive home place the frozen food in the freezer immediately.
- Keep the time between buying chilled food and placing it in your freezer as short as possible.
- Do not push food together too much, try to allow air to circulate around each item.
- Do not store food uncovered.
- Ensure that food placed in the freezer is dated and labelled and used in date order to ensure that food is consumed at its best.
- Remove suspect food from your freezer and clean spills- refer to "Maintenance and Cleaning" on page 8.

Energy Saving Advice

- Do not install the appliance close to sources of heat, such as a cooker, dishwasher or radiator.
- Use the appliance in a cool, well-ventilated room and make sure that the ventilation openings on the casing are not obstructed.
- Avoid unnecessary frosting in the cabinet by packing all food stuffs into airtight packages before placing them in the freezer.

- Always leave warm food to cool down to room temperature before placing in the freezer.
- Food which is to be frozen (when cool) should be placed in the fridge before being transferred to the freezer.
- Thaw frozen food in the fridge. This will ensure safer defrosting of foods.
- Try to avoid keeping the door open for long periods, or opening the door too frequently as warm air will enter the cabinet, and cause the compressor to switch on unnecessarily.
- Ensure there are no obstructions preventing the door from closing properly.

In the Event of a Power Failure

If there is a power failure during the storage of frozen foods, keep the door closed. If the temperature within your freezer should rise do not re-freeze the food without checking its condition.

The following guidelines should assist you:

Ice Cream: Once thawed should be discarded.

Fruit and Vegetables: If soft should be cooked and used up.

Bread and Cakes: Can be re-frozen without danger.

Shell fish: Should be refrigerated and used up quickly.

Cooked Dishes: (eg. Casseroles): Should be refrigerated and used up.

Large Pieces of Meat: Can be re-frozen, provided that there are ice crystals remaining within them.

Small Joints: Should be cooked and then re-frozen as cooked dishes.

Chicken: Should be cooked and re-frozen as a fresh dish.

MAINTENANCE AND CLEANING

 Before any maintenance or cleaning work is carried out, DISCONNECT the appliance from the ELECTRICITY supply.

Internal Cleaning

Clean the inside and the baskets with warm water and bicarbonate of soda (5ml to 0.5 litre of water). Wipe clean and dry thoroughly.

 Do not use detergents, abrasive powders, highly perfumed cleaning products, wax polishes or cleaning products containing bleach or alcohol.

External Cleaning

Wash the outer cabinet with warm soapy water.

 Do NOT use abrasive products. There are sharp edges on the under side of the product so care should be taken when cleaning.

To Defrost the Freezer

1. Wrap any food in layers of newspaper or blankets, if you do not have access to another freezer.
2. Switch the appliance off at the wall socket and remove the plug.
3. Open the freezer door.
4. Place a suitable container to collect the defrost water.
5. After defrosting, clean and dry the interior.
6. Switch the appliance on and replace any frozen food.

-  Defrosting can be speeded up by putting bowls of hot (not boiling) water in the freezer and loosening the frost with a suitable (ie. not sharp) plastic scraper.
- If the temperature of frozen food is allowed to rise during defrosting, its storage life may be shortened.

When the Appliance is Not in Use

When the appliance is not going to be used for a long period, disconnect from the electricity supply, empty all of the food and clean the appliance, leaving the door ajar to prevent a build up of stale smells.

TROUBLESHOOTING

BEFORE contacting a service agent, check the following points:

Symptom	Solution
No power to the appliance	Check that there is power at the socket.
	Check that the fuse has not blown.
The temperature in the freezer section is too high	Check that the ambient temperature is within the freezer's operating limits of 16°c to 32° c. Relocate the appliance if necessary
	Check that the thermostat is turned to the correct setting, relative to ambient conditions.
The freezer door will not open	If the door has just been opened, you may need to wait a minute or two for the pressure. to equalise.
The compressor runs continuously	Make sure that the thermostat is not set to "Super". See " Thermostat Control" on page 5 for details.
	Check that the door is closed properly and that the door seals are intact and clean.
	Large quantities of food have recently been placed in the freezer and /or the door is frequently opened.
	Check that sufficient ventilation is available. See "Ventilation Requirements" on page 11 for details.
Excessive frost and ice has built up	Ensure the door is not left open.
	Check that nothing is preventing the door from closing.
	Check that the door gasket (seal) is intact and clean.
	Defrost the freezer as described on page 8 (" See To Defrost the Freezer ").
Noise	Refer to "Normal Operating Sounds" on page 7.

If after the above checks there is still a fault, contact Customer Support for assistance. In warranty customers should ensure that the above checks have been made before sending for repair, as fees may be levied if the fault is not a mechanical or electrical breakdown.

Door Reversal

This refrigerator has been built with the door hinges on the right. If you wish to change the opening direction, follow the instructions below:

1. Remove the upper hinge cover (6) first.
2. Remove the two screws (1) that hold the upper hinge (5) (right side) to the frame. Take away the upper hinge (5).
3. Lift the door and place it on a padded surface to prevent scratching it.
4. Remove the two screws (8) that hold the lower hinge (2) and then remove the lower hinge (2).
5. Remove the left front leg (4) and transfer it to the right side.
6. Move the hole cover plate (7) to the right side.
7. Before placing this lower hinge (2), remove the bolt-pin (9) and reverse the direction of the lower hinge (2). Then install the lower hinge (2) onto the left side of the lower frame with two screws (8).
8. Insert the bolt-pin (9) into the lower hinge (2).
9. Set the door in place, making sure the door seat at the lower hinge(2).
10. While holding the door in the closed position, attach the upper hinge (5) left side of the top frame with two screws (1), do not tighten the two screws (1) until the top of the door is parallel to the counter top.
11. Install the upper hinge cover (6) on the upper hinge.

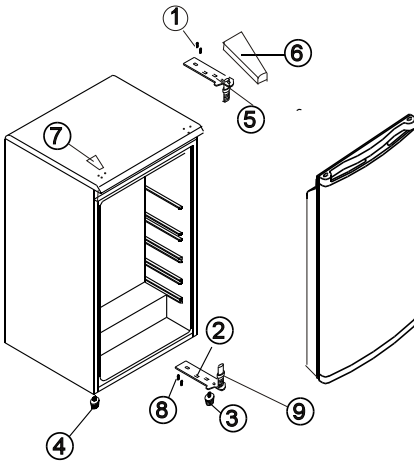

FIGURE 1

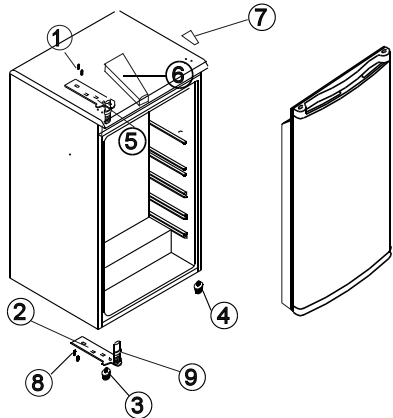

FIGURE 2

FIGURE 1 - REPRESENTS POSITION OF COMPONENTS PRIOR TO DOOR REVERSAL.

FIGURE 2 - REPRESENTS POSITION OF COMPONENTS AFTER DOOR REVERSAL.

Installation Requirements

To ensure correct operation, this appliance must not be located where the temperatures will fall below 16°C or rise above 32°C.

Avoid the following location: unventilated kitchen, outhouse, conservatory, garage. For correct operation this appliance must be installed:

In a dry location.

Out of direct sunlight.

Away from extreme temperature (ie. not next to a cooker or other sources of heat).

Your appliance will be even heavier when loaded with food and must therefore be stood on a strong, firm floor.

Ventilation Requirements

Gently push the freezer into place, ensuring that the back of the freezer maintains a gap of 50mm (2") from the wall. When in position a 50mm (2") clear space above the appliance should ideally be maintained.

If insufficient space is available above the freezer, a clearance of 25mm (1") should be maintained on both sides.

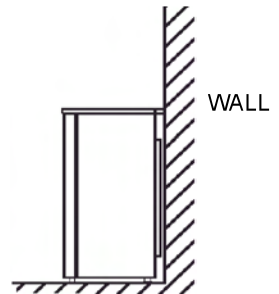

Ensure that the appliance does not stand on the electrical supply cable.

Whenever possible, the back of the appliance should be close to a wall, leaving the required distance for ventilation.

Levelling

The appliance should be level during use.

To eliminate rocking:

Ensure the appliance is upright and both adjusters are in firm contact with the floor so that the cabinet is level.

Adjust the level by screwing out the appropriate level adjuster at the front (use your fingers or a suitable spanner).

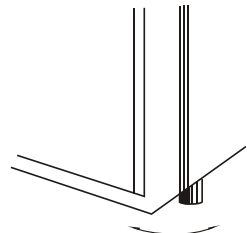

This appliance is heavy. Care should be taken when moving it.

* For detailed specifications, please refer to the name plate at the back of the freezer. The specifications are subject to change without prior notice.

Warnings

- * This appliance is not intended for use by persons (including children) with reduced physical, sensory or mental capabilities, or lack of experience and knowledge, unless they have been given supervision or instruction concerning use of the appliance by a person responsible for their safety.
- * Children should be supervised to ensure that they do not play with the appliance. If the supply cord is damaged, it must be replaced by the manufacturer, its service agent or similarly qualified persons in order to avoid a hazard.
- * Keep ventilation openings, in the appliance enclosure or in the built-in structure, clear of obstruction.
- * Do not use mechanical devices or other means to accelerate the defrosting process, other than those recommended by the manufacturer.
- * Do not damage the refrigerant circuit
- * Do not use electrical appliances inside the food storage compartments of the appliance, unless they are of the type recommended by the manufacturer.

IMPORTANT DISPOSAL INSTRUCTIONS



As a responsible retailer we care about the environment.

As such we urge you to follow the correct disposal procedure for your product and packaging materials. This will help conserve natural resources and ensure that it is recycled in a manner that protects health and the environment.

You must dispose of this product and its packaging according to local laws and regulations. Because this product contains electronic components and sometimes batteries, the product and its accessories must be disposed of separately from household waste when the product reaches its end of life.

Contact your local authority to learn about disposal and recycling.

The product should be taken to your local collection point for recycling.

Some collection points accept free of charge.

We apologise for any inconvenience caused by minor inconsistencies in these instructions, which may occur as a result of product improvement and development.

Free Manuals Download Website

<http://myh66.com>

<http://usermanuals.us>

<http://www.somanuals.com>

<http://www.4manuals.cc>

<http://www.manual-lib.com>

<http://www.404manual.com>

<http://www.luxmanual.com>

<http://aubethermostatmanual.com>

Golf course search by state

<http://golfingnear.com>

Email search by domain

<http://emailbydomain.com>

Auto manuals search

<http://auto.somanuals.com>

TV manuals search

<http://tv.somanuals.com>