

Installation

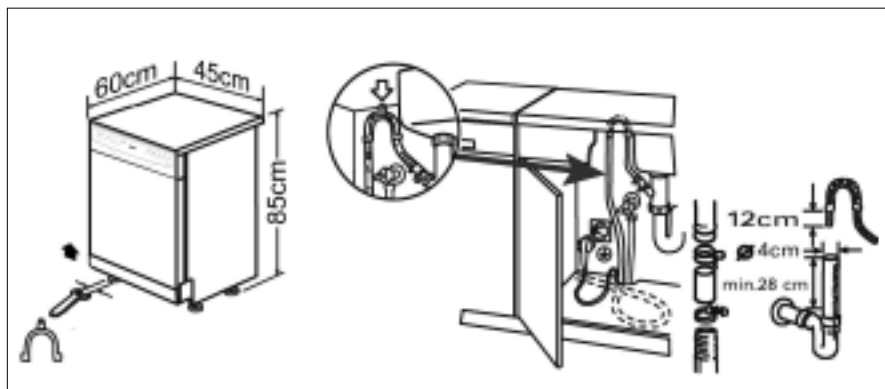



Haier

Domestic Dishwasher DW9-AFE

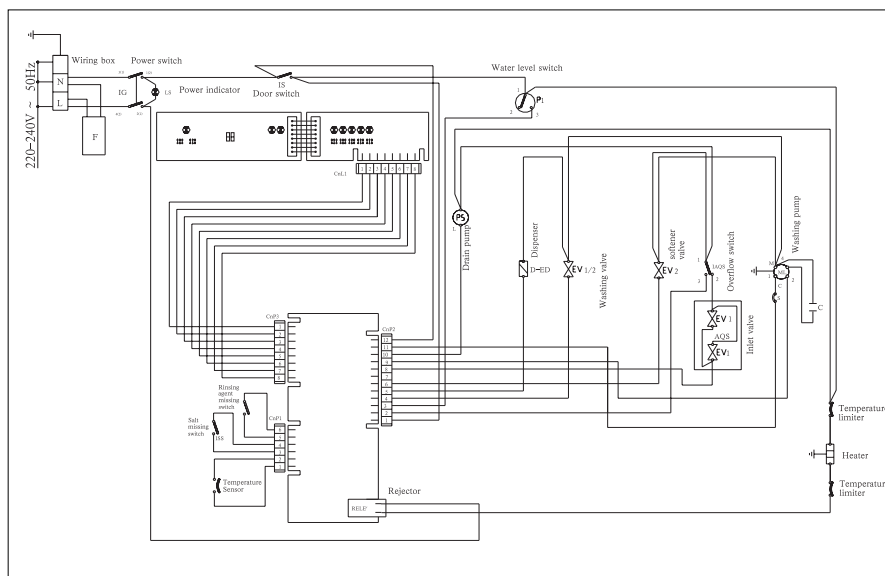

Diagram



The symbol  on the product or on its packaging indicates that this product may not be treated as household waste. Instead it shall be handed over to the applicable collection point for the recycling of electrical and electronic equipment. By ensuring this product is disposed of correctly, you will help prevent potential negative consequences for the environment and human health, which could otherwise be caused by inappropriate waste handling of this product.

For more detailed information about recycling of this product, please contact your local city office, your household waste disposal service or the shop where you purchased the product.

GB

Code:0120505667

Safety Hints

Carefully read the instructions contained in this manual, as they provide important information which is essential to safe and proper installation, use and maintenance of this appliance.

CE This appliance complies with the following EEC directives:

-73/23/EEC of 19/02/73 (Low Voltage) and subsequent modifications;

- 89/336/EEC of 03/05/89 (Electromagnetic Compatibility) and subsequent modifications.

- Carefully dispose of the packing material.

- After removing the packing, check to make sure that the appliance is not damaged. If in doubt, contact a qualified professional.

- The dishwasher must only be used by adults for the washing of household dishes and cooking utensils.

- The appliance is not intended for use by young children or inform persons without supervision.

- Young children should be supervised to ensure that they do not play with the appliance.

- Keep detergents out of the reach of children.

- This appliance cannot be installed outdoors, not even if the area in which it is installed is covered by a roof; It is also very dangerous to leave it exposed to the rain and elements.

- Do not lean or sit on the door when it is open as this could overturn the dishwasher.

- Do not touch the heating element during or after a wash cycle.

- If the appliance malfunctions turn off water supply to the appliance and disconnect the plug from the wall socket. Refer to the section entitled, "Troubleshooting". If you cannot solve the problem, contact a authorised service centre.

- Only specialised personnel are authorised to make repairs.

- Appliances which are no longer being used must be made inoperable by cutting the power supply cord and removing the door lock.

- If the supply cord is damaged, it must be replaced by manufacturer, its service agent or similarly qualified persons in order to avoid a hazard.

- After installation, the power plug must be accessible.

- Rules to follow when using this appliance:

* Never touch the dishwasher when barefoot or with wet hands;

* We discourage the use of extension cords and multiple sockets;

* During installation, the power supply cord must not be excessively or dangerously bent or flattened;

* If the appliance is not operating properly, maintenance must be performed, disconnect the appliance from the power supply.

Warning: Dishwasher detergents can be extremely dangerous if swallowed. Avoid contact with skin and eyes and keep children away from the dishwasher when the door is open. Check that the detergent receptacle is empty after completion of the wash cycle.

To maintain the EFFICIENCY and SAFETY of this appliance, we recommend:

- call only service centres authorised by the manufacturer.

- always use original Spare Parts

Close-up View (Control Panel)

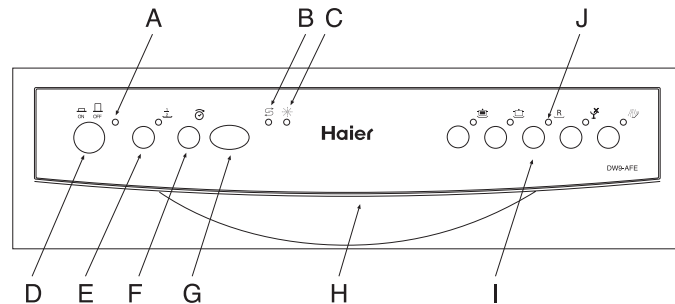

- | | | | |
|---|-------------------------------|---|-------------------------|
| A | ON-OFF Light | F | Delay Select Button |
| B | Low Salt Indicator Light | G | Display Delay Time |
| C | Low Rinse Aid Indicator Light | H | Handle For Opening Door |
| D | ON-OFF Button | I | Cycle Select Button |
| E | Half-load Button | J | Cycle indicator light |

.1.

GB

Close-up View (Interior)

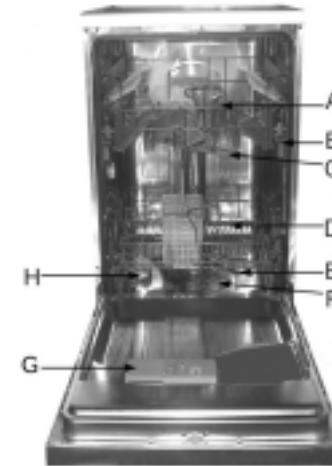

- | | | | |
|---|----------------------|---|-----------------------------------|
| A | Upper Rack | E | Bottom Spray Arm |
| B | Rack Height Adjustor | F | Washing Filter |
| C | Top Spray Arm | G | Detergent and Rinse Aid Dispenser |
| D | Lower Rack | H | Salt Container Cap |

Specifications

Width	45 cm
Depth	60 cm
Height	85 cm
Capacity	9 standard place settings
Mains Water Pressure	0.03-0.6MPa
Power Voltage	220-240V~ 50Hz
Total Absorber Power	1950W

.2.

GB

Salt

Salt

The hardness of the water varies from place to place. If hard water is used in the dishwasher, deposits will form on the dishes and utensils.

The appliance is equipped with a special softener that uses a salt specifically designed to eliminate lime and minerals from the water.

Loading the Salt into the Softener

Always use salt intended for use with dishwashers.

The salt container is located beneath the lower rack and should be filled as follows:

- Remove the lower rack and then unscrew and remove the cap from the salt container;
- If you are filling the container for the first time, fill it with water;
- Place the end of the funnel (supplied) into the hole and introduce about 2 kg of salt. It is normal for a small amount of water to come out of the salt container.
- Carefully screw the cap back on.



Adjusting Salt Consumption

The dishwasher is designed to allow for adjusting the amount of salt consumed based on the hardness of the water used. This is intended to optimise and customise the level of salt consumption so that it remains at a minimum. Your local Water Board can supply the degree of hardness of the water in your area.

To adjust salt consumption, proceed as follows:

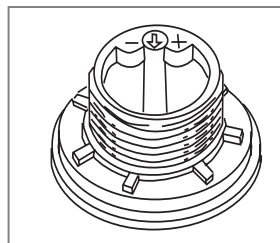

- Unscrew the cap from the salt container;
- There is a ring on the container with an arrow on it (see figure). If necessary, rotate the ring in an anticlockwise direction from the "-" setting towards the "+" sign, based on the hardness of the water being used.

It is recommended that adjustments be made in accordance with the following scheme:

Water Hardness							
Level	Clarke degrees	°dH	mmol/l	Selector position	Salt consumption (Grams/cycle)	Autonomy (cycles/2kg)	
1	0 14	0 17	0 1,7	/	0	/	
2	14 36	18 44	1,8 4,4	"-"	20	60	
3	36 71	45 89	4,5 8,9	MED	40	40	
4	>71	>89	>8,9	"+"	60	25	

The salt container must be filled when the "low salt" indicator light (located on the control panel) comes on.

To prevent the formation of rust, load the salt just before beginning a wash cycle.

Detergent and Rinse Aid

Detergent

Detergent specifically intended for use with dishwashers must be used. The dispenser must be refilled before the start of each wash cycle following the instructions provided in the "Wash Cycle Table." The detergent dispenser is located on the inside panel of the door.

Loading the detergent

To open the "A" cover on the dispenser, press the "B" button. The detergent for the wash cycle should be poured into the "C" compartment.

After the detergent has been placed in the dispenser, close the cover and press down until it clicks in place.

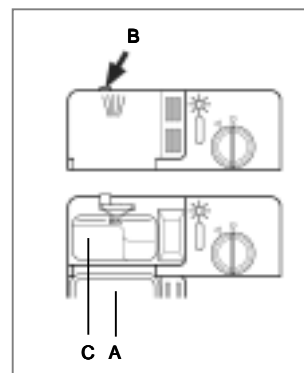

Note: To facilitate closing the cover, remove any excess detergent on the edges of the dispenser.

Rinse Aid

This product makes dishes sparkle and helps them to dry without spotting. The dispenser is located on the inside panel of the door and should be filled after every 80 wash cycles (or when the rinse aid indicator light comes on for those models with this feature).

Loading the Rinse Aid

To open the dispenser, turn the "C" cap in an anti-clockwise direction and then pour in the rinse aid, making sure not to overflow. The amount of rinse aid used for each cycle can be regulated by turning the "F" dose adjuster, located beneath the "C" cap, with a screwdriver. There are 6 different settings; the normal dosage setting is 3.

Important

Proper dosage of the rinse aid improves drying.

If drops of water remain on the dishes or spotting occurs, the dosage adjuster should be turned to a higher setting.

If the dishes have white streaks, turn the dosage adjuster to a lower setting.

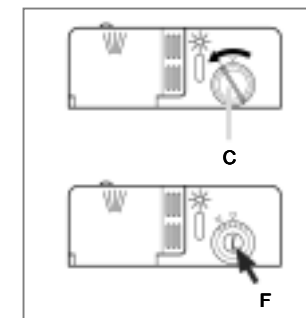

Loading the Dishwasher

Before placing the dishes in the dishwasher, remove larger food particles to prevent the filter from becoming clogged, which results in reduced performance.

If the pots and pans have baked-on food that is extremely hard to remove, we recommend that they are soaked before washed. This will eliminate the need for extra wash cycles.

Pull out the rack to load the dishwasher.

How to use the lower rack

We recommend that you place the most difficult to clean items on the bottom rack: pots, pans, lids, serving dishes and bowls, as shown in the figure to the right.

It is preferable to place serving dishes and lids on the sides of the racks in order to avoid blocking the rotation of the top spray arm.

- Pots, serving bowls, etc. must always be placed face down.
- Deep pots should be slanted to allow the water to flow out.
- The lower rack features fold down tine rows (see fig.A) so that larger or more pots and pans can be loaded.
- The silverware basket can not be doubled (see fig.B).
- Silverware should be placed in the silverware basket with the handles at the bottom; if the rack has side baskets, the spoons should be located individually into the appropriate slots. Especially long utensils should be placed in the horizontal position at the front of the upper rack.

How to use the upper rack

The upper rack is designed to hold more delicate and lighter dishware, such as glasses, cups and saucers, plates, small bowls and shallow pans (as long as they are not too dirty).

- Position the dishes and cookware so that they do not get moved by the spray of water.

Adjust the upper basket to the higher level and you have more space to accommodate those taller pans and trays in the bottom basket.

Shelf

Lean tall glasses and those with long stems against the shelf-not against other items to be washed.

Place glasses, cups and small bowls on the additional cup rack. The additional cup rack can be swivelled in or out as required(see fig.C).

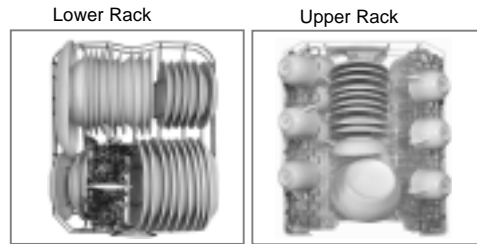

Load for 9 Standard Settings

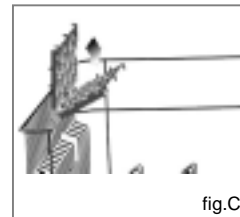
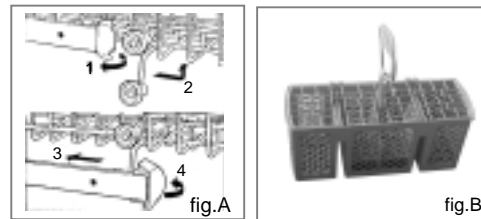

Turning on the Appliance

Starting a wash cycle

After having completed all of the installation steps in the preceding paragraphs, turn on the water all the way and press the ON-OFF button (D) located on the control panel. The "A" indicator light will come on. At this point, the appliance is on but you must wait a few seconds before programming the cycle setting.

Setting and Starting a wash Cycle

Select the desired cycle by pressing the selector button (I). Each time the button is pressed, one of the "J" cycle indicator lights will come on in succession. Choose the wash cycle you feel is most appropriate for the type of dishes that need washing (consult the wash cycle table contained in this manual. After a few seconds, the wash cycle has begun and can no longer be changed.

Canceling or modifying a cycle

A cycle that is underway can only be modified if it has only been running for a short time. Otherwise, the detergent may have already been used, and the appliance may have already drained the wash water. If this is the case, the detergent dispenser must be refilled (see the paragraph entitled, "Loading the Detergent"). To modify a cycle that is already underway, press the ON/OFF button (D), all of the settings will be cancelled. To set a new cycle, follow the instructions contained in the paragraph entitled "Setting and starting a wash cycle".

Wash Cycle Program Light

The dishwasher is equipped with a LED indicator light (J) that turns on when the appliance is running the wash cycle.

At the end of the wash cycle

Six beeps will indicate that the wash cycle has finished and the cycle indicator light (J) for the cycle will begin to die out. Turn off the appliance using the ON-OFF button. Turn off the water supply to the appliance and open the door. Wait a few minutes before unloading the dishwasher to avoid handling the dishes and utensils while they are still hot and more susceptible to breakage. They will also dry better.

Setting the Wash Cycle with a Delayed Start Time

By pressing the "F" button (see close-up view-'Control panel') the start of wash cycle can be delayed for between 1 to 12 hours. Each time the button is pressed, the display (G) will show the number of hours for the delay period. Choose the amount of time desired. After selecting the wash cycle, a short acoustic signal will sound and after a few seconds, the delay time on the display will blink. This indicates that the countdown has begun.

After the time has lapsed, the cycle will start.

NOTE:

During the delay period, it is preferable not to change any of the settings, if this is necessary, all of the settings must be cancelled by pressing the ON/OFF button (D).

At this point, all of the steps for "setting the wash cycle with a Delayed Start Time" and "Setting and Starting a wash cycle" must be repeated, following the instructions contained in the corresponding sections.

If the door is opened to the unit during the delay period, the countdown will stop. It will begin again when the door is closed. All of the wash cycle set to reverse time function, we may in focus start circulate time.

Wash Cycle adjustment Buttons

1/2 load Button

This button (see "close-up View - Control Panel", letter"E") makes it possible to wash dishes using only the upper rack if there are not enough dishes for a full load. This will allow you to save on water and power. It can be used before setting any of the wash cycle, except for the intensive cycle (if included in the wash cycle table). Please keep in mind that the amount of detergent should also be cut in half.

Energy Saving Tips

- It is important to try and run the dishwasher when it is fully loaded in order to save on energy. To prevent odors from forming and food from caking onto the dishes, you can run the soak cycle.

- Choose the right wash cycle: the choice of cycle depends on the type of dishware, cookware and utensils being washed and how dirty they are.

- Use the right amount of detergent: if you use too much detergent, the result will not be cleaner dishes, but, rather, a greater negative impact on the environment.

How to Keep Your Dishwasher in Shape

After Every Wash

After every wash, turn off the water supply to the appliance and leave the door slightly ajar so that moisture and odors are not trapped inside.

Remove the Plug

Before cleaning or performing maintenance, always remove the plug from the socket.

No Solvents or Abrasive Cleaning Products

To clean the exterior and rubber parts of the dishwasher, do not use solvents or abrasive cleaning products. Use only a cloth and warm soapy water.

To remove spots or stains from the surface of the interior, use a cloth damp and a little white vinegar, or a cleaning product made specifically for dishwashers.

Moving the Appliance

If the appliance must be moved, try to keep it in the vertical position. If absolutely necessary, it can be positioned on its back.





Seals

One of the factors that cause odors to form in the dishwasher is food that remains trapped in the seals. Periodic cleaning with a sponge will prevent this from occurring.

When You Go on Holiday

When you go on holiday, it is recommended that you run a wash cycle with the dishwasher empty and then remove the plug from the socket. Turn off the water supply and leave the door of the appliance slightly ajar. This will help the seals last longer and prevent odors from forming within the appliance.

Wash Cycle Table

Cycle	Cycle Selection Information	Description of Cycle	Detergent	Rinse Aid
 Heavy Duty	Very dirty dishes, pots and pans. (not to be used with delicate items)	Pre-wash with warm water. Extended wash at 70 °C. Rinse with cold water. Rinse with hot water. Drying.	30g	
 Normal Wash	Normal dirty dishes, pots and pans. standard daily cycle.	Pre-wash with cold water. Extended wash at 55 °C. Rinse with cold water. Rinse with hot water. Drying.	30g	
 Rapid Wash	Economic, fast cycle to be used on not very dirty dishes right after they are used. No drying cycle.	Short wash at 40 °C. Cold rinse .	15g	
 Glass ware (EN50242)	Economic, test cycle for IECEN50242	Pre-wash with cold water. Extended wash at 48 °C. Rinse with cold water. Rinse with hot water.	5+25g	(5)
 Soak	Pre-wash of dishes, pots and pans while waiting for the load to be completed after the subsequent meal.	Short cold wash to prevent food residue from drying on the dishes .		

Cleaning and Special Maintenance

Filter Assembly

For best performance and results, the filter assembly must be cleaned.

The filter efficiently removes food particles from the wash water, allowing it to be recirculated during the cycle. For this reason, it is a good idea to remove the larger food particles trapped in the filter after each wash cycle by rinsing the "A" semi-circular filter and cup under running water. To remove the filter assembly, pull on the cup handle in the upward direction. The entire filter assembly (made up of the "A" semicircular filter and the "B" fine filter) should be cleaned at least once a month. To clean the filter and the fine filter, use a cleaning brush. Then, reassemble the filter parts as shown in the figures below and reinsert the entire assembly in the dishwasher, positioning it in its seat and pressing downward.

The dishwasher must never be used without the filters. Improper replacement of the filters may reduce the performance level of the appliance and damage dishes and utensils.

Cleaning the Spray Arms

It may happen that food particles become encrusted on the sprayer arms and block the holes (see "Close up view interior", letters C-E). Check the sprayer arms periodically and clean them when needed.

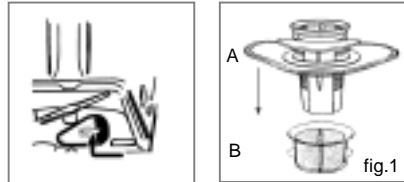

Cleaning the Water Inlet Filter

Periodically clean the water inlet filter (see fig.1/A) located on the outlet of the water supply tap.

After turning off the water tap, unscrew the end of the water supply hose, remove the filter and clean it carefully under running water. Then, return the filter to its place and tighten the water supply hose back into position.

Troubleshooting

It may occur that the dishwasher does not function or does not function properly. Before calling for assistance, see what can be done first: Have you forgotten to press one of the buttons or to perform an essential operation?

The dishwasher does not start

Have you checked whether:

- the plug is pushed into the socket correctly;
- the power is on in the house;
- the door is closed properly;
- the ON-OFF switch is on "ON";
- the water supply is turned on.

The dishwasher does not load water

Have you checked whether:

- the water is turned on and the hose is connected properly;
- the water supply to the house is on and has sufficient pressure;
- the water supply hose is crimped or bent;
- the filter for the water supply hose is clogged.

The dishwasher does not drain

Have you checked whether:

- the drain hose is crimped or bent.

Lime deposits or a white film form on the dishes

Have you checked whether:

- the lid to the salt container is closed properly;
- the rinse aid dosage is correct.

If, despite all these checks, the dishwasher still does not function and/or the problem persists, contact the nearest authorised service centre and provide them with the following information:

- the nature of the problem;
- the model and the serial number which are indicated on the plate located on the side of the inner part of the door.

Never call on unauthorised technicians and refuse to allow parts to be installed that are not original spare parts.

Installation

Positioning the Appliance

Position the appliance in the desired location. The back should rest against the wall behind it, and the sides, along the adjacent cabinets or wall. The dishwasher is equipped with water supply and drain hoses that can be positioned to the right or the left to allow proper installation.

Levelling the Appliance

Once the appliance is positioned, adjust the feet (screwing them in or out) to adjust the dishwasher, making it level. In any case, the appliance should not be inclined more than 2°. If the appliance is level, it will help ensure proper performance.

Cold Water Connection

Connect the cold water supply hose to a threaded 3/4" (gas) connector making sure that it is fastened tightly in place (see Fig.1). If the water pipes are new or have not been used for an extended period of time, let the water run to make sure that the water is clear and free of impurities. If this precaution is not taken, there is a risk that the water inlet can get blocked and damage the appliance.

Hot Water Connection

The water supply to the appliance can also be connected to the house's hot water line (centralised system, heating system), as long as it does not exceed a temperature of 60°. In this case, the wash cycle time will be shortened by about 15 minutes and the wash efficiency slightly reduced.

The connection must be made to the hot water line following the same procedures as those for the connection to the cold water line.

Anti-Flooding Protection

The dishwasher is equipped with a system that stops the supply of water in the event of a problem with the water supply hose, or leaks within the unit. If for any reason the box containing the electrical components happens to get damaged, remove the plug from the socket immediately. In order to guarantee that the anti-flooding feature operates properly, the "A" box with water supply hose must be attached to the water supply tap as shown in Fig.1. No other type of connection is acceptable. The water supply hose must not, under any circumstances, be cut, as it contains electrical parts which are live. If the length of the hose is not adequate to make a proper connection, the hose must be replaced with one that is long enough. This hose is available upon request from specialised retailers and service centres.

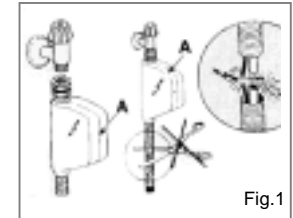

Attention:

The appliance is to be connected to the water mains using new hose-sets and old hose-sets should not be reused!

Installation

Drain Hose Connection

Insert the drain hose into a drain pipe with a minimum diameter of 4cm, or let it run into the sink, making sure to avoid bending or crimping it. Use the special plastic support that comes with the appliance (see Fig.2). The free end of the hose must be at a height between 40 and 100 cm and must not be immersed in water.

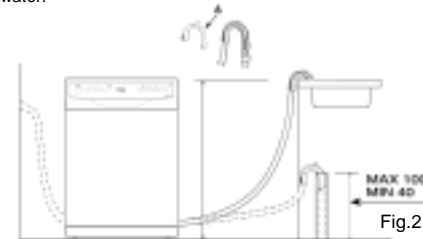

Attention:

The special plastic hose support must be solidly fastened to the wall to prevent the drain hose from moving and allowing water to spill outside the drain.

Electrical Connection

After making sure that the voltage and frequency values for the current in the home correspond to those on the rating plate (located on the stainless steel inner door of the appliance) and that the electrical system is sized for the maximum voltage on the rating plate, insert the plug into an electrical socket which is earthed properly (the earthing of the appliance is a safety requirement mandated by law).

If the electrical socket to which the appliance must be connected is not appropriate for the plug, replace the plug rather than using adapters or the like as they could cause overheating and burns.

Free Manuals Download Website

<http://myh66.com>

<http://usermanuals.us>

<http://www.somanuals.com>

<http://www.4manuals.cc>

<http://www.manual-lib.com>

<http://www.404manual.com>

<http://www.luxmanual.com>

<http://aubethermostatmanual.com>

Golf course search by state

<http://golfingnear.com>

Email search by domain

<http://emailbydomain.com>

Auto manuals search

<http://auto.somanuals.com>

TV manuals search

<http://tv.somanuals.com>