

Microwave Oven

HDN-3090EGF

HDN-3090EGS

HDN-3090EGB

Owner's Manual

Haier

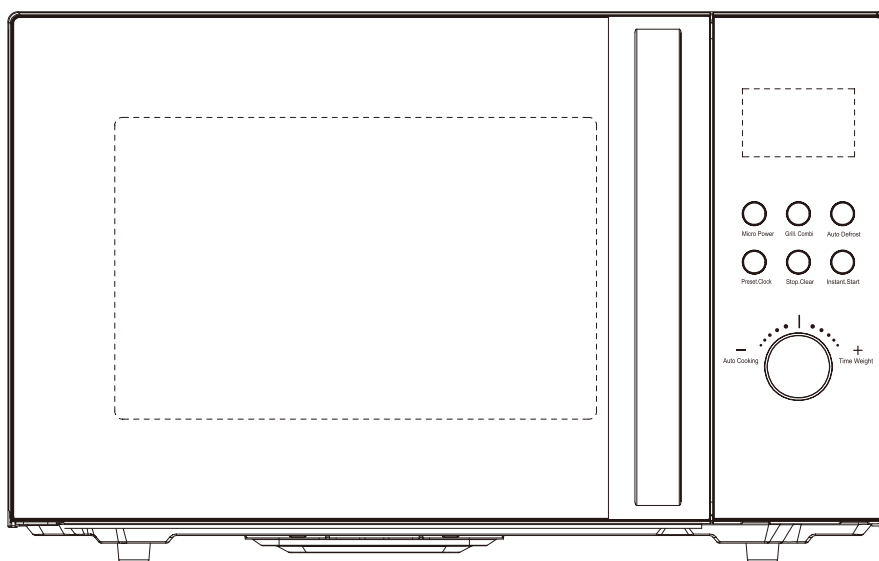

Please read this booklet carefully before fixing and using and save it for future reference.

INSTALLATION OF MICROWAVE OVEN

- 1) To ensure sufficient ventilation, the distance of the back of microwave to the wall should be at least 10 cm, the side to the wall should be at least 5cm, the free distance above the top surface at least 20 cm.
- 2) The appliance should be operated with the rear side placed against a wall.
- 3) Do not place any objects on the top of microwave oven.
- 4) The position of the oven shall be such that it is far from the TV, Radio or antenna as picture disturbance or noise may occur.
- 5) The appliance must be positioned so that the plug is accessible.
- 6) The microwave oven is intended to be used freestanding and shall not be placed in a cabinet.
- 7) To keep the microwave oven at a distance from the wall, it is necessary to install a distance limiter.

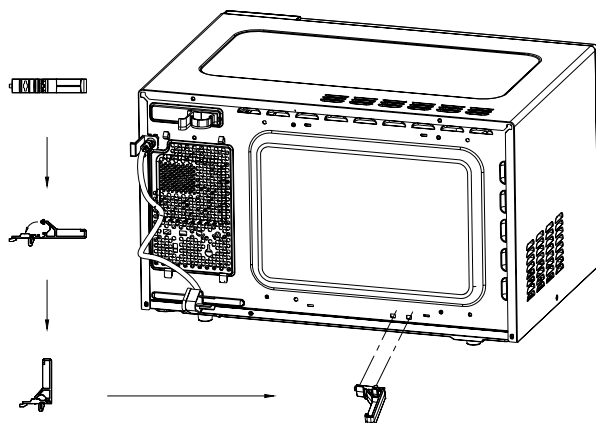

UTENSILS GUIDELINE

It is strongly recommended to use the containers which are suitable and safe for microwave cooking. Generally speaking, the containers which are made of heat-resistant ceramic, glass or plastic are suitable for microwave cooking. Never use the metal containers for microwave cooking and combination cooking as spark is likely to occur. You can take the reference of below table.

Material of container	microwave	Grill	Combi	Notes
Heat-resistant ceramic	Yes	No	No	Never use the ceramics which are decorated with metal rim or glazed
Heat-resistant plastic	Yes	No	No	Can not be used for long time microwave cooking
Heat-resistant glass	Yes	No	No	
Grill rack	No	Yes	Yes	
Plastic film	Yes	No	No	It should not be used when cooking meat or chops as over temperature may do damage to the film

FOR THE FIRST USE

As there is manufacturing residue or oil remained on the oven cavity or heat element, it usually would smell the odor, even a slight smoke, It is normal case and would not occur after several times use, keep the door or window open to ensure good ventilation. So it is strongly recommended to set the oven to grill mode and operate dry several times. Operating dry can only be conducted in the grill mode, it can not be conducted at combination mode

IMPORTANT SAFEGUARDS

The following basic precautions should always be followed when using electrical appliance:

1. Read all instructions before using.
2. Make sure the voltage in your living area corresponding to the one shown on the rating label of the appliance. And the wall socket is properly grounded.
3. To reduce the risk of fire in the oven cavity:
 - a. Do not overcook the food.
 - b. Remove wire twist-ties from paper or plastic bags before placing bags in the oven.
 - c. Do not heat oil or fat for deep drying as the temperature of oil cannot be controlled.
 - d. After use wipe the waveguide cover with a damp cloth, followed by dry cloth to remove any food splashes and grease. Built-up grease may overheat and begin to cause smoke or catch fire.
 - e. If materials inside the oven should smoke or ignite, keep oven door closed, turn oven off and disconnect the power supply.
 - f. Close supervision is necessary when using disposable containers made from plastic, paper or other combustible material.
4. To reduce the risk of explosion and sudden boiling:
 - a. Do not place sealed containers in the oven. Baby bottles fitted with a screw cap or teat are considered to be sealed containers.
 - b. When boiling liquid in the oven, use the wide-mouthed container and stand about 20 seconds at the end of cooking to avoid delayed eruptive boiling of liquids.
 - c. Potatoes, sausage and chestnut should be peeled or pierced before cooking. Eggs in their shell, whole hard-boiled eggs should not be heated in microwave ovens since they may explode, even after microwave heating has ended.
 - d. The cooked eggs or liquid should not be removed out immediately. Several moments should be waited before removing In order to avoid possible hazards caused by delayed eruptive boiling of liquids.
 - e. The contents of feeding bottles and baby food jars are to be stirred or shaken and the temperature is to be checked before consumption, in order to avoid burns.
5. Never operate the oven further if the door or door seals are damaged or the oven is malfunctioned or supply cord is damaged. Return the appliance to the nearest authorized service center for repair and maintenance. Never try to adjust or repair the oven yourself.
6. If the supply cord is damaged it must be replaced by the manufacturer or its service agent or a qualified technician in order to avoid a shock hazard.
7. After cooking, the container is very hot. Using gloves to take out the food and avoid steam burns by directing steam away from the face and hands.
8. Slowly lift the furthest edge of dishes cover and microwave plastic wrap and carefully open popcorn and oven cooking bags away from the face.
9. To prevent the turntable from breaking:
 - a. Let the turntable cool down before cleaning.
 - b. Do not place hot foods or utensils on the cold turntable.
 - c. Do not place frozen foods or utensils on the hot turntable.
10. Make sure the utensils do not touch the interior walls during cooking.
11. Failure to maintain the oven in a clean condition could lead to deterioration of the surface that could adversely affect the life of the appliance and possibly result in a hazardous situation.
12. Only use utensils that are suitable for use in microwave ovens.
13. Do not store food or any other things inside the oven.

14. Do not operate the oven without any liquid or food inside the oven. This would do damage the oven.
15. This appliance is not intended for using by young children or infirm persons without supervision.
16. When the appliance is operated in the combination mode, children should only use the oven under adult supervision due to the temperatures generated.
17. Any accessories not recommended by the manufacturer may cause injuries to persons.
18. Do not use outdoors.
19. Save these instructions.
20. This appliance is not intended for used by persons (including children) with reduced physical, sensory or mental capabilities, or lack of experience and knowledge, unless they have been given supervision or instruction concerning use of the appliances by a person responsible for their safety.
Children should be supervised to ensure that they do not play with the appliance.
21. The appliance is not intended to be controlled by an external timer or separate remote-control system

Household use only

PRODUCT INTRODUCTION

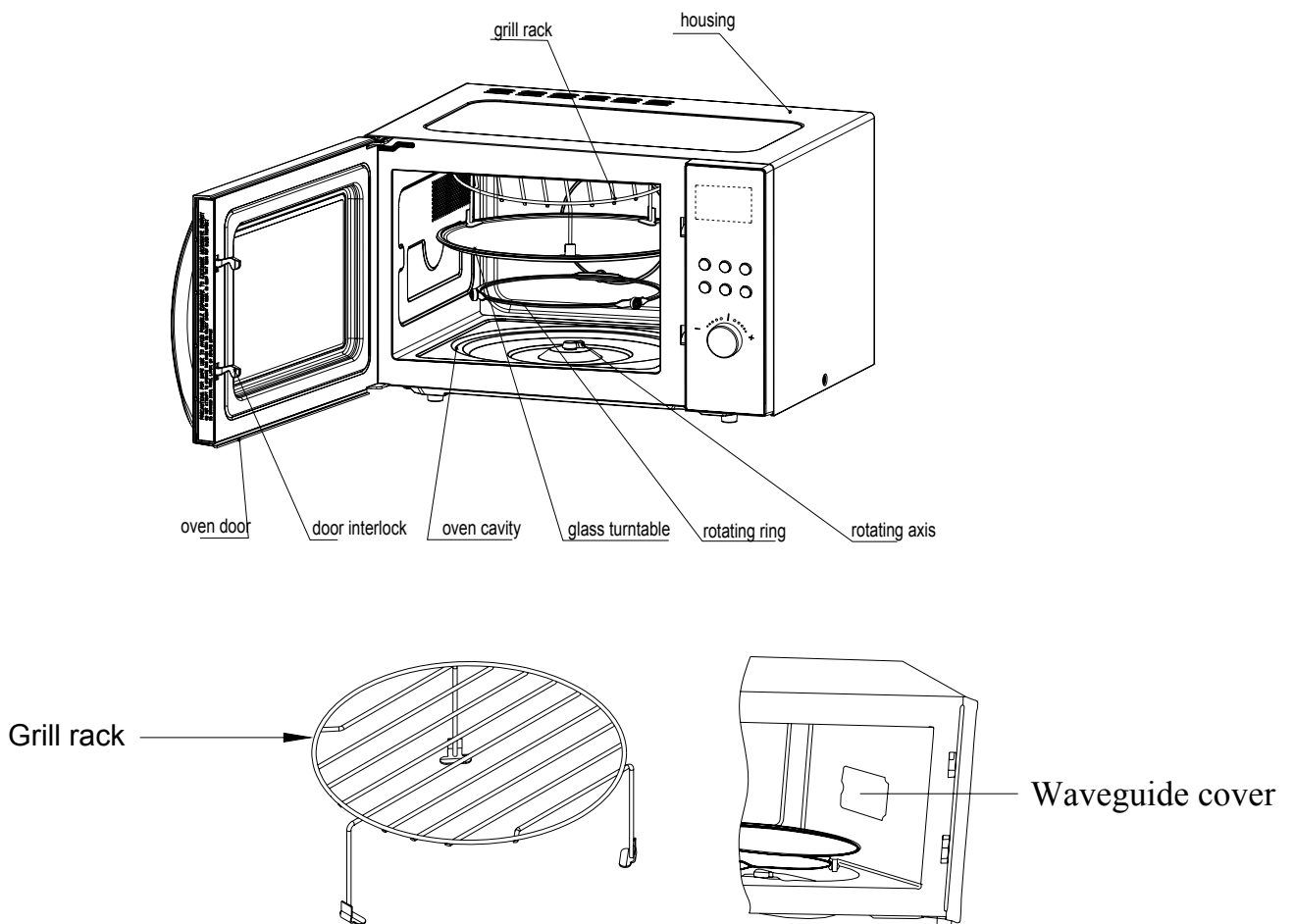

Fig.1

Notes:

1. Door interlock ensures the oven can only be activated when the door is properly closed, which would



prevent microwave radiation.

2. Control panel is illustrated in next page (the control panel is subject to change without prior notice).
3. Do not remove the Waveguide cover during cleaning (see Fig.1).
4. Glass turntable turns to make food are heated evenly.
5. Grill rack is used to place the roasting food
6. LCD will show the clock time, cooking mode and left operation time, which depends on the current set mode.

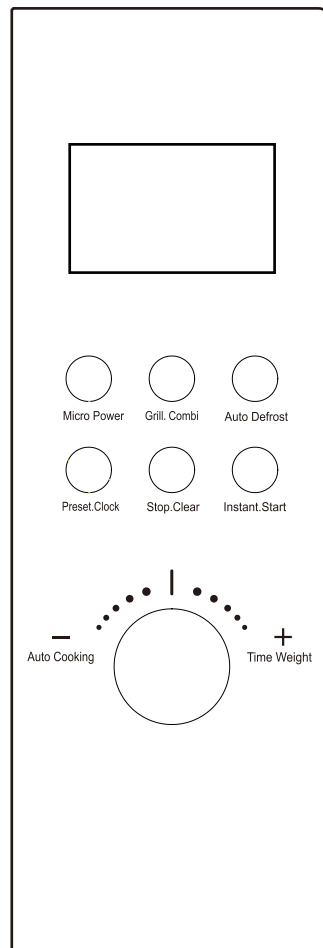
OPERATION OF CONTROL PANEL



1. Before cooking

The LCD will flash  3 times when plugged in power supply. Then it will flash , prompting you to input the cooking menu and time.

2. Time. weight/Auto cooking knob

You can select auto cooking menu and increase or decrease cooking time and weight during operation by turning **Time. Weight/ Auto cooking knob**.

3. Stop/Clear

At the initial or input stage: press once to cancel input programs and resume initial stage.
During cooking: press once to stop oven operation, press twice to cancel cooking programs.

4. Auto reminder

When your preset cooking procedure have finished, the LCD Display will show **End** and three beeps sound will be heard to prompt you to take out food. If you do not press **Stop. Clear** button once or open the door the beep will be sounded at an interval of 3 minutes.

5. Child lock function

Use this feature to lock the control panel when you are cleaning or so that children can not use the oven unsupervised. . All the buttons are rendered inoperable in this mode.

To set child lock, depress and hold **Stop. Clear** button about 3 seconds until LCD appears **OFF**.

To cancel child lock, depress and hold **Stop. Clear** button about 3 seconds until LCD appears colon.

6. Microwave cooking

Press Micro Power button, LCD will cycle to show 100P 80P 60P 40P 20P

100P--- High power, 100% microwave power.

Applicable for quick and thorough cooking, such as meat, vegetable

80P --- Medium High power, 80% microwave power. Applicable for medium express cooking, such as eggs, fish, congee, rice, soup

60P --- Medium power, 60% microwave power. Applicable for steaming food

40 P --- Medium Low power, 40% microwave power. Applicable for defrosting food

20P --- Low power, 20% microwave power. Applicable for keeping warm

NOTE:

1) The max time which can be set is 60 minutes and 00 seconds.

2) Never use the Grill rack during microwave cooking.

3) Never operate the oven empty.

4) If you turn the food during operation, press the Instant. Start button once and the preset cooking procedure will continue.



5) If you intend to remove the food before the preset time, you must press Stop. Cancel button once to clear the preset procedure to avoid unintended operation of next time use.



7. Grill.Combi

Press this button LCD will cycle to show G, C.1, C.2.

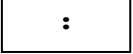
G--- Grill, the heat element will be energized during operation time. Which is applicable for grilling thin meats or pork, sausage, chicken wing as good brown color can be obtained.

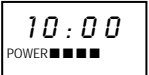
C.1--- Combination of Grill and microwave cooking. Heat element and magnetron is energized in an alternate way. Utilizing the properties of microwave penetration thick food is suggested to cook in this mode, as the center of food can be done and brown

Depress	Display
Example: To cook at 80P for 10 minutes.	
1. After power-up, the colon flashes or press Stop. Clear button once	
2. Select the desired microwave power by depressing Micro Power button consecutively	
3. Set the cooking time by turning the Time. weight/ Auto cooking knob	
4. Press Instant. Start to start and LCD will count down to show running time.	
You may change the cooking time during cooking. And it is recommend to turn the food halfway, after you turn the food. Press Instant. Start button once to...	

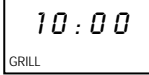
Depress	Display
Example: To grill food with C.2 for 10 minutes	
1. After power-up, the colon flashes or press Stop. Clear button once	
2. Select the desired cooking menu by pressing Grill/Combi button	
3. Set the cooking time by turning the Time. Weight /Auto cooking knob	
4. Press Instant.Start to start, and LED will LCD count down to Show running time.	

crust still can be obtained.

C.2--- Same as C1 except more microwave cooking time. Applicable for thick meats, chicken, drumsticks, the inside can be done and brown crust color can still be obtained on the outside.

Note: it is not necessary to preheat for grill cooking.

Warning:

In the mode of grill/combi of the oven parts, as well as the rack and cooking containers, may become very hot. Use caution when removing any item from the oven. Use heavy potholders or oven mitts to PREVENT BURNS.

8. Auto defrost

Press the button and the LCD display will circle to show d.1 d.2 d.3.



d.1 --- for defrosting meat, the weight range from 0.1Kg to 2.0 Kg.

d.2 --- for defrosting poultry, the weight range from 0.2 to 3.0Kg.

d.3 --- for defrosting seafood, the weight range from 0.1to 0.9Kg.

Note:

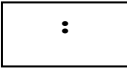

1. It is necessary to turn over the food during operation to obtain uniform effect.
2. Usually defrosting will need longer time than that of cooking the food.
3. If the food can be cut by knife, the defrosting process can be considered completed.
4. Observe the below Defrost guide to achieve best performance.

Depress	Display
Example: To defrost 0.2kg poultry	
1. After power-up, the colon flashes or press Stop.Clear button once	
2. Select the food kind by pressing Defrost button	
3. Set defrosting weight by turning the Time. Weight/Auto cooking knob	
4. Start cooking by pressing Instant. Start , and LCD will count down to show running time.	
5. Half way during defrosting 3 beep sound will be heard two times to prompt you turn over the food. Open the door and turn over the food and shield the warm portion. Pressing Instant.Start button again to continue the defrosting. If you do not when an audible signal sounds, the defrosting cycle will continue until the time count down to 0.	





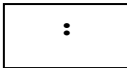
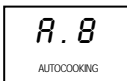



9. Auto cooking

The oven has default cooking menu for simple operation. When the LCD flash colon, turn the Time Weight/Auto cooking knob and LCD will cycle to show A.1、 A.2 A.8.

Choose the appropriate menu according to the food type and weight and strictly observe the directions of below table, otherwise the cooking effect will be largely influenced.

Depress	Display
Example: Steam 0.45kg fish	
1. After power-up, the colon flashes or press Stop. Clear button once	
2. Choose the appropriate menu by turning the Time. Weight/Auto cooking knob	
3. Start cooking by pressing Instant.Start , and LCD will count down to show running time.	

Auto cook table

Display	Category	Direction
	Popcorn	Suitable for popping a bag of corn, which is available in the market, weighted 3.0Oz(85g). Popcorn prior to completing, if the popping speed has been decreased to 1 time per 1-2 seconds you should press Stop.Clear button to stop the popping process
	Popcorn	Same as <i>A.1</i> except 3.5Oz(100g) weight
	Pizza	Warm a piece of chilled pizza of 0.15Kg
	Beverage	Heating a cup of 250 ml liquid. The liquid temperature is about 5-10°C. Use a big mouth cup and do not seal
	Beverage	Heating a cup of 500 ml liquid. The liquid temperature is about 5-10°C. Use a big mouth cup and do not seal
	Potato	Cooking the potato strips, cut into 5mm width and height, length. Total weight is about 0.45kg. Place the strips on a large dish and cover the dish with a thin film to prevent water loss
	Potato	Same as <i>A.6</i> except the weight of potato strips is about 0.65Kg
	Fish	Suitable for steaming a fish of 0.45Kg. After the fish washed and scales removed, make a slits on the skin of fish .Put the fish on a shallow dish of 22-27cm diameter sprinkle lightly with some ingredient and cover the dish with a thin film to prevent water loss. After cooking, stand for 2 minutes.









Note:

1. The cook time above is based on the food which of the room temperature of 20-25°C. Results will vary for the food in different temperature.
2. The temperature, weight and shape of food will largely influence the cooking effect. If any deviation has been found to the factor noted on above menu, you can adjust the cooking time for best result.

10. Automatic starting (delayed function)

If you do not want the menu be started immediately, you can preset the cooking menu and time and the preset menu will be automatically started at your set time. The setting will consist of 2 steps: 1. Setting the current clock; 2. Setting the cooking menu and time.

Example: Now it is 12:00 clock, if you hope that the microwave oven will automatically start cooking with 100P microwave power for 9 minutes and 30 seconds at 14:20



Depress	Display	Depress	Display
1. Set the current time		2. Set the cooking menu and time	
1.1 Depress Preset. Clock button		2.1 Select cooking power by pressing Micro. Power button	
1.2 turning Time. Weight/ Auto cooking button to set hours, and hours will be flashed		2.2 turning Time. Weight / Auto Cooking to set cooking time	
1.3 Depress Preset. Clock button again		2.3 To return to current clock. Hold Clock for 3 seconds, then a short beep sound will be heard	
1.4 turning Time. Weight / Auto cooking button to set minutes, and minutes will be flashed		3. Set the time you expect to start. Repeat the steps of 1.2, 1.3, 1.4	
1.5 Depress Preset. Clock or waiting for 5 seconds, and the numbers will go steady.		4. Depress Preset. Clock button to confirm the delayed menu. Now the program has been activated. And the menu will be Started at 14:20	
		5. You may check the preset starting time by depressing Preset. Clock button	

Note: Delayed function is not applicable for **auto cook** and **auto defrost**.

11. Multi-sequence cooking

To obtain best cooking result, some recipes call for different cook and time. You may program your personalized menu as follow:

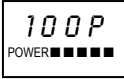
Example: You want cook food with 100P microwave for 3 minutes then grill food for 9 minutes. This is 2 sequence setting.

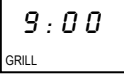
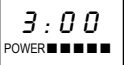
Depress	Display	Depress	Display
1. 100P microwave for 3min		2. Grill food for 9min	
1.1 Press Micro Power button to select menu		2.1 Press Grill. Combi button to select menu	
1.2 turning Time. Weight/Auto cooking to set cooking time		2.2 turning Time. Weight / Auto cooking to set cooking time	
		3. Start cooking by pressing Instant. Start	

When microwave power cooking is finished, microwave oven will begin grilling operation automatically.

Note: Max 4 sequence can be set per time repeat the steps 1.1, 1.2 if you like to set more.

MICROWAVE COOKING TIPS

1) Arranging food

Place thicker areas toward outside of dish and the thinner meat in the center and spread them evenly. Do not overlap if possible.

2) Cooking time

Start cooking with the shorter period of time and extend it according to the actual need. Overcooking may result in smoking and burning.

3) Cover foods before cooking refer to the recipe

Use paper towels, microwave plastic wrap or a cover to cover food so that prevent spattering and help foods to cook evenly. (Helps keep oven clean).

4) Partial shielding of food

Use small pieces of aluminum foil to cover thin areas of meats or poultry to avoid overcooking.

5) Stir foods

From outside to center of dish once or twice during cooking, if possible.

6) Turn foods

Foods such as chicken, hamburgers or steaks should be turned over once during cooking.

7) Rearrange foods

Please change the positions of food in half way during cooking such as: from top to bottom and from the center of the dish to the outside.

8) Allow standing time

After cooking ensure adequate standing time. Remove food from oven and stir if possible. Cover for standing time which allows the food to finish cooking without overcooking.

9) Check for doneness

Observe the food color and hardness to determine whether the food is cooked. Doneness signs include:

- Steams throughout food, not just at edge part.
- Joints of Poultry move easily.
- Pork and poultry show no evidence of blood.
- Fish is opaque and flakes easily with a fork.

10) Condensation

It is a normal case of microwave cooking. The humidity and moisture of food will influence the amount of moisture in the oven. Generally, covered foods will not cause as much condensation as uncovered foods. Ensure that the ventilation openings are not blocked.

11) Microwave safe plastic wrap

For cooking food with high fat content, do not bring the wrap in contact with the food as it may melt.

12) Microwave safe plastic cookware

Some microwave safe plastic cookware are not suitable for cooking foods with high fat and sugar content.

CLEANING AND MAINTENANCE

The oven should be cleaned regularly and any food deposits removed.

Suggest you perform below steps after every time use.

Never use hard detergent, gasoline, abrasive powder or metal brush to clean any part of the appliance.

Clean the oven at regular intervals

Disconnect the power supply cord before cleaning. And if possible leave the door open to inactivate the oven during cleaning.

Exterior:

The outside may be cleaned wipe with a soft and damp cloth. Avoid the use of harsh abrasive cleaners.

Door:

Wipe the door and window on both sides, the door seals and adjacent parts frequently with a damp cloth to remove any spills or splatters. Do not use abrasive cleaners.

Control panel:

Care should be taken in cleaning the control panel. Wipe the panel with a cloth dampened slightly. Do not scrub or use any sort of chemical cleaners.

Interior walls:

To clean the interior surfaces, wipe with a soft and damp cloth for hygienic reasons. After use wipe the waveguide cover in the oven with a soft damp cloth to remove any food splashed. Buildup splashes may overheat and begin to smoke or catch fire. Do not remove the waveguide cover. Do not use a commercial oven cleaner, abrasive or harsh cleaners and scouring pads on any part of your microwave oven. Never spray oven cleaners directly onto any part of your oven.

Turntable/ Rotating ring/Rotating axis

Wash with mild soapy water and dry thoroughly.

TIP: When the microwave oven has been used for a long time, there may be some strange odors exist in oven, Following 3 methods can get rid of them:

1. Place several lemon slices in a cup, then heat with high power for 2-3 min.
2. Place a cup of red tea in oven, then heat with high power.
3. Put some orange peel into oven, then heat them with high power for 1 minute.

SERVICING

Warning: it is hazardous for anyone, other than a qualified service technician, to carry out any service for repairing operation which involves removal of any cover which gives protection against exposure to microwave energy.

Caution: MICROWAVE RADIATION

Do not become exposed to radiation from the microwave generator or other parts conducting microwave energy.

During servicing below listed parts are liable to be removed and give access to potentials above 250V to earth.

1. Magnetron
2. High voltage transformer
3. High voltage capacitor
4. High voltage diode
5. High voltage fuse

Below listed condition may cause undue microwave exposure during servicing.

- 1. Unproper fitting of magnetron.**
- 2. Unproper matching of Door interlock, door hinge and door.**
- 3. Unproper fitting of switch support.**
- 4. Door, Door seal or enclosure has been damage.**

English version:

Correct Disposal of this product	
	<p>This marking indicates that this product should not be disposed with other household wastes throughout the EU. To prevent possible harm to the environment or human health from uncontrolled waste disposal, recycle it responsibly to promote the sustainable reuse of material resources. To return your used device, please use the return and collection systems or contact the retailer where the product was purchased. They can take this product for environmental safe recycling.</p>

Free Manuals Download Website

<http://myh66.com>

<http://usermanuals.us>

<http://www.somanuals.com>

<http://www.4manuals.cc>

<http://www.manual-lib.com>

<http://www.404manual.com>

<http://www.luxmanual.com>

<http://aubethermostatmanual.com>

Golf course search by state

<http://golfingnear.com>

Email search by domain

<http://emailbydomain.com>

Auto manuals search

<http://auto.somanuals.com>

TV manuals search

<http://tv.somanuals.com>