

Haier

海爾家用微波爐使用說明書

User's Manual of Haier Household Microwave Oven

型號: MO-2270MG (VC)/(N) / MM-2270MG (VC)/(N)

Model: MI-2270MG (VC)/(N) / MK-2270MG (VC)/(MS)

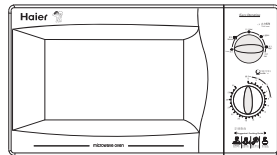

MO-2270MG (VC)/(N)

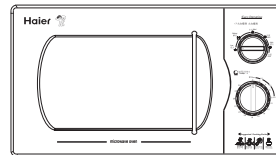

MI-2270MG (VC)/(N)

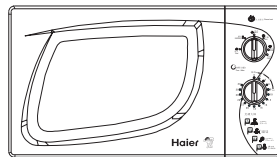

MM-2270MG (VC)/(N)

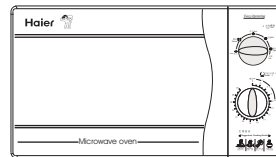

MK-2270MG (VC)/(MS)

該系列微波爐執行國家標準:

GB 4706.21-2002 GB/T 18800-2002

GB 4706.22-2002

- 安裝、使用產品前，請仔細閱讀本使用說明書
- 微波爐外觀、顏色和圖案見實物
- 本說明書中型號後面出現的所有“(VC)”、“(N)”、“(MS)”均為企業廠內標識，並非產品型號的一部分，其中“(MS)”表示不鏽鋼膽

The series of microwave oven comply with the following national standards:

GB 4706.21-2002 GB/T 18800-2002

GB 4706.22-2002

- Please read the manual before use.
- Please refer to the physical product for the appearance, color and pattern.
- All of the marks following the model number of the product, such as (VC), (N) and (MS) are internal symbols of the factory, not belonging to any part of the model number, in which (MS) indicates stainless cavity.

目錄

各部分構件名稱	1
電氣原理圖	1
產品規格	1
安全注意事項	2
拆箱 · 安裝 · 放置環境	2-3
操作板功能介紹	3
使用方法	3
烹調器皿的選用	4
微波爐的烹調技巧	5
保養 · 維修	5
疑難解答 · 售後服務	6

各部分構件名稱

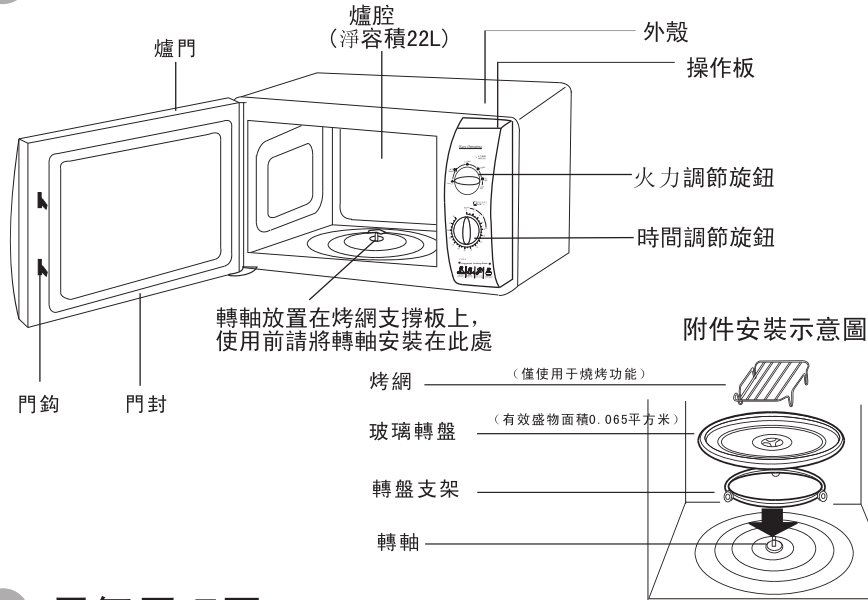

電氣原理圖

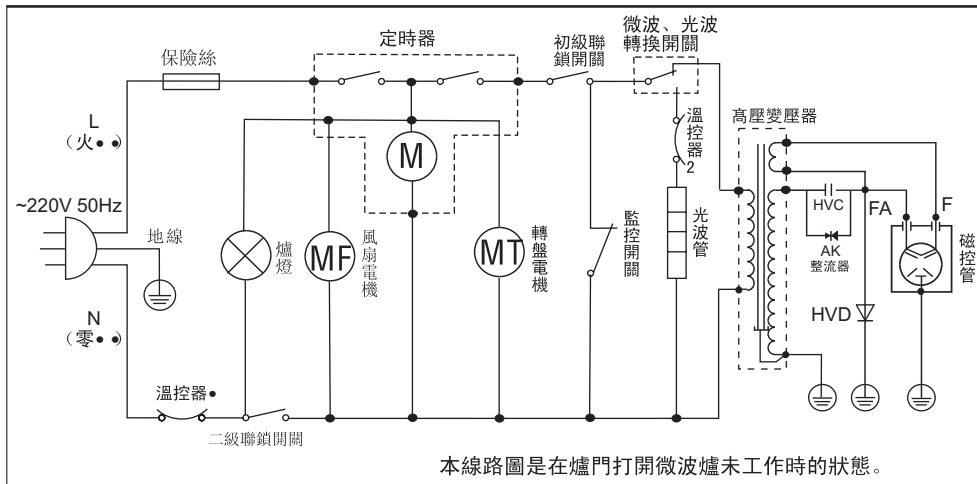

產品規格

型號	電源電壓 (V/Hz)	輸入功率 (W)	輸出功率 (W)	燒烤功率 (W)	微波頻率 (MHz)	爐內容積約 (L)	外形尺寸 (mm) (高 X 闊 X 深)	爐內淨容積約 (mm) (高 X 闊 X 深)
MO-2270MG	~220/50	1200	700	950	2450	22	288X486X370	196X311X312
MM-2270MG	~220/50	1200	700	950	2450	22	288X486X380	196X311X312
MI-2270MG	~220/50	1200	700	950	2450	22	288X486X376	196X311X312
MK-2270MG	~220/50	1200	700	950	2450	22	288X486X370	196X311X312

所列尺寸為約數，由于我們在不斷地改進我們的產品，因此如果技術參數有任何變動，恕不另行通知。

安全注意事項

請仔細閱讀安全注意事項，這樣您可以安全方便地使用海爾微波爐！

- 1、不能使用金屬棒探入爐腔前部的聯鎖開關孔，此舉可能導致危險。
- 2、禁止對爐門的反方嚮用力過大，可能會造成爐門變形，導致微波泄漏。
- 3、禁止使用密閉容器，對帶皮食物要進行刺孔處理。
- 4、注意清理爐腔內殘留油脂，不推薦使用塑料等可燃器皿，否則加熱時可能會冒煙或者著火，務必不要遠離，時時觀察。
- 5、食品烹調完畢後，在打開容器蓋子或撕開保鮮膜時，注意避免被高溫蒸氣燙傷。
- 6、微波加熱時，不得使用金屬器皿進行烹調，否則會發生打火現象。
- 7、燒烤烹調時，注意不要觸摸門屏及外殼上部，避免燙手。
- 8、爐腔處於高溫狀態時（如燒烤烹調結束後）不能立即使用微波烹調，直至爐腔充分冷卻。

- 警告：如果微波爐門或門封已損壞，則不得再使用，直到經有資格的維修人員修好為止。
- 警告：除有資格的維修人員外，其他人來執行檢修操作都是危險的，包括拆下防止微波能量泄漏的防護蓋等操作。
- 警告：不要直接加熱裝在密封容器內的液體或其他食物，因為這樣有可能發生爆炸。
- 警告：只有在已經提供充分的指導以致於兒童能夠採用安全的方法使用微波爐，並且明白不正確的使用會造成危險時，才能允許兒童在無人監控的情況下使用微波爐。
- 在微波爐內僅能使用適合的器皿。（參看“烹調器皿的選用”部分）
- 當加熱用塑料或紙包裝的食物時，應注意觀察微波爐內食品，因為有著火的可能。
- 如發現有煙霧，應立即拔掉器具電源插頭，並保持爐門關閉，以抑制火焰蔓延。 **警告**
- 微波加熱液體（飲料等）會導致延遲噴濺沸騰，因此取出時必須小心謹慎。
- 奶瓶和嬰兒食品罐應經過充分攪拌或搖動，喂食前應檢查瓶內食物的溫度，避免燙傷。
- 微波爐不能用來加熱帶殼的鮮蛋和已煮熟的蛋，因為在用微波加熱時甚至在加熱之後它們可能會發生爆炸。
- 微波爐內無食物時，請不要使用微波爐，以免空載運行損壞機器。
- 在微波爐附近不要放置易燃、可燃物品，微波爐在工作期間，務請隨時監控微波爐烹調情況，並正確設定烹調時間，因為超時烹調可能引起火災。
- 含水量較少的輕負載食品在烹調過程中，由於不同物質對微波的吸收能力不同，可能存在冷熱不均，屬正常現象。
- 在使用燒烤或微波長時間加熱後，不能立即進行解凍，需等玻璃轉盤冷卻後再進行解凍。
- 不可使用尖銳利器（如清潔球、鏟勺等）清潔玻璃轉盤。
- 不要戳穿爐門網孔，否則會造成微波泄漏。

本品不得用于工業及商用目的

拆箱 • 安裝 • 放置環境

拆箱

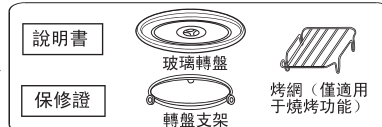
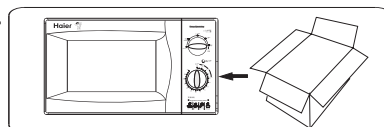

安裝

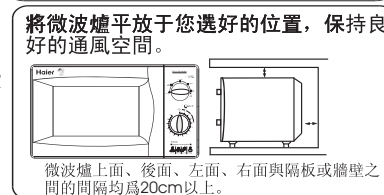

放置環境

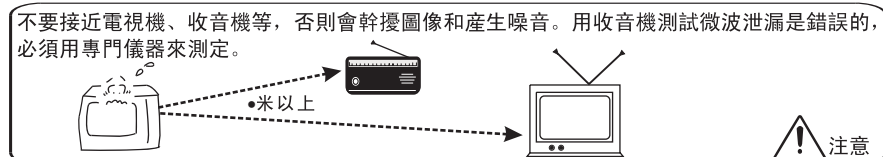

放置
環境

微波爐安裝時應留有散熱空間；不能放置在潮濕、高溫的環境中。



注意

操作板功能介紹

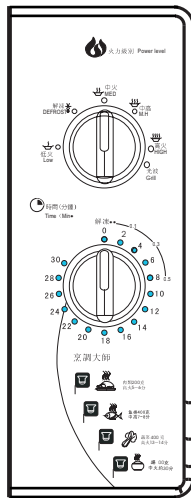

1. “火力級別”旋鈕

使用“火力級別”旋鈕可以調節您所需要的烹調火力和烹調方式。

2. “時間（分鐘）”旋鈕（最大時間30分鐘）

使用“時間（分鐘）”旋鈕選擇適當的烹調時間。

微波火力說明

- 微波輸出功率120W
- 微波輸出功率230W
- 微波輸出功率380W
- 微波輸出功率540W
- 微波輸出功率700W
- 微波輸出功率950W

操作板上方的“烹調指南”，可供您在烹調時參考。

使用方法

使用“火力級別”、“時間（分鐘）”旋鈕設定烹調火力及時間。

- 將食物放于適合器皿內，打開爐門，將烹調器皿置于轉盤中部後，關閉爐門。
- 使用“火力級別”旋鈕，根據烹調程度選擇適當的烹調火力。順時針轉動“時間（分鐘）”旋鈕，設定烹調時間。
- 注意：時間一旦設定，微波爐立即開始工作。若設定時間短于2分鐘，需要將“時間（分鐘）”旋鈕轉至超過2分鐘，然後扭回到期望設定的時間。
- 如果在烹調過程中打開爐門，微波爐將停止工作，爐燈亮；關閉爐門，烹調繼續進行。當烹調時間結束時，可聽到鈴聲，微波爐停止工作，烹調結束。
- 如果進行光波燒烤烹調，到設定時間的一半時請直接打開爐門將食物翻面。
- 使用燒烤時，將均勻擺滿食物的耐熱陶瓷盤或玻璃轉盤置于玻璃轉盤中部，嚴禁與爐腔接觸。
- 解凍食物時，將“火力級別”旋鈕旋轉至“解凍”檔，再順時針轉動“時間（分鐘）”旋鈕，設定合適的解凍時間。解凍時間可根據食物重量來定：

如：0.1Kg食物解凍時間為3分鐘左右

0.3Kg食物解凍時間為5分鐘左右

0.5Kg食物解凍時間為8分鐘左右

操作板底部印有“烹調指南”，可供您在烹調時參考。

注意：使用燒烤型微波爐時，禁止將電源線與外殼上部光波管部位接觸，以免在使用燒烤功能時電源線搭在外殼上造成軟化變形，形成安全隱患。

烹調器皿的選用

微波烹調器皿的選用

微波特性

使用微波爐請選用合適的烹調器皿



食物吸收



玻璃透射

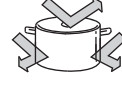

金屬反射

容器的種類	微波烹調	燒烤烹調	組合烹調
耐熱性 玻璃容器 	✓ 可用	✓ 可用	✓ 可用
非耐熱性 玻璃容器 	✗ 不可用	✗ 不可用	✗ 不可用
耐熱性 塑料容器 	✓ 可用 • 請使用有[可微波爐用]標識的容器。	✗ 不可用	✗ 不可用
非耐熱性 塑料容器 	✗ 不可用 • 受微波影響變質的容器不能使用。 • 只有在解凍生鮮食品時，泡沫托盤才可以使用。	✗ 不可用	✗ 不可用
陶、瓷 容器 	✓ 可用 • 有彩圖、金銀裝飾的容器不能使用。	✓ 可用 • 內側有彩圖的容器會引起顏色剝落，避免使用。	✓ 可用
漆器 	✗ 不可用 • 有可能發生漆脫落、斷裂現象。	✗ 不可用	✗ 不可用
鋁等金屬 制成的容器 	✗ 不可用 • 金屬網等也會引起火花，不能使用。 • 微波爐專用的著色用盤（金屬制品）也不能使用。	✓ 可用 • 把手是樹脂材料的話，也不能使用。	✗ 不可用
木·竹· 紙制品 	✗ 不可用 • 容易燃燒。	✗ 不可用 • 經過耐熱加工處理的紙制品能使用。	✗ 不可用
保鮮膜、 耐熱PE袋 	✓ 可用 • 多油料理（如烹調肉類及油炸食品）會產生高溫，不能使用。	✗ 不可用 • 經受高溫會熔化。	✗ 不可用
鋁箔 	✗ 不可用 • 解凍食品時可適當使用。	✓ 可用 • 鋁箔把食物包好進行烘烤。	✗ 不可用

注：料理完畢後，玻璃轉盤要自然冷卻，不要用冷水沖洗，否則會造成玻璃轉盤爆裂。

微波爐的烹調技巧

微波爐的烹調技巧

食品溫度	食品的溫度越低，烹調的時間越長，冷凍食品要比常溫食品加熱時間長。
食品濕度	因為微波易被潮濕食品吸收，所以食品濕度越大，加熱時間越短。
食品形狀	因為微波只能穿透食品表面以下2-4公分，所以食品的厚薄會影響到加熱時間。
食品密度	緊密的食品與疏松的食品加熱時間不同，前者所需時間要長一些。
食品數量	微波能量是一定的，不因食品的多少而改變，所以食品數量越大，所需加熱時間越長。
骨頭和脂肪	骨頭傳熱較快，肥肉吸收微波能量較多，所以烹調帶骨和帶脂肪的肉類注意局部過熱。
加蓋	將食品放入帶蓋容器烹調，可以減少熱量和蒸氣的散發，縮短烹調時間。
放置	食品烹調時應均呈環狀擺放，盡量避免疊放，這樣有利于提高均勻性。
攪拌	當加熱湯、汁料或飲品等液體食物時，加熱前以及加熱過程中略加攪拌，可有效防止液體沸濺。
加封	用保鮮膜包蓋食品，可以防止湯汁飛濺弄髒爐腔，而且可以保持水分和營養。
擱置	食品從微波爐取出後，食品內部仍在加熱，可以擱置一段時間，火候因素應予考慮。

保養 · 維修

保養：經常性的清潔保養，是微波爐正常工作的保證。

清潔前一定要把微波爐電源斷開

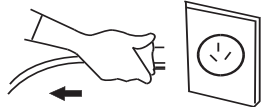

不要使用清潔劑及含有金屬材質的清潔物品清潔爐腔及爐門



外殼層，使用軟布蘸肥皂水清潔，並用柔軟的乾布擦淨。

用濕布清除爐門、門封和爐腔內的食物屑，用濕布蘸肥皂水清除油垢。

保持爐門內部的清潔，避免留有食物殘渣，引起爐腔打火或產生異味，同時防止油垢腐蝕轉輪或爐腔內生成鏽斑。

一周至少將其取出一次，放入肥皂水中清洗，防止油垢腐蝕轉輪。

如果電源軟線損壞，為避免危險，必須由製造廠或其維修部或類似的專職人員來更換。

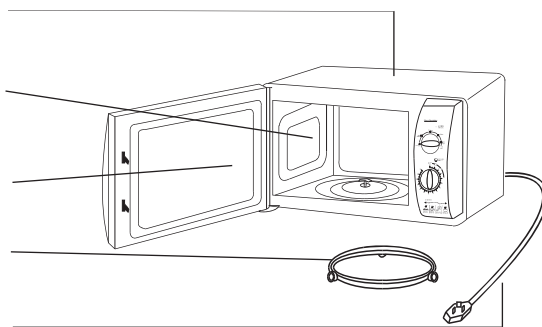

注：微波爐長期不用時，注意將爐體各部位可能殘留的水漬、油垢擦乾淨，避免生鏽。



警告

如果微波爐工作異常或損壞，在專業維修人員維修完畢之前，請不要繼續使用。

疑難解答 · 售後服務

問題解答

為什麼爐燈不亮？

- 1、燈泡壞了；
- 2、未定時。

為什麼微波爐不工作？

- 1、沒插電源；
- 2、微波爐用的插座壞了；
- 3、爐門關閉不嚴，導致開關不閉合。

為什麼啓動時有“嘭”的聲音？

此屬正常現象，是變壓器高電壓高頻率情況下工作的啓動聲音。

為什麼工作時噪音大？

- 1、轉盤支架沒放正；
- 2、玻璃轉盤放歪；
- 3、將變壓器、磁控管及高速散熱風扇的工作聲音和較小的共振聲音誤認爲噪音。

為什麼不加熱或加熱慢？

- 1、沒通電源；
- 2、在進行功能選擇時，沒選加熱功能。

為什麼蒸汽會從排風口冒出？
為什麼有水從爐門下溢出？

蒸汽冒出是烹調過程中的正常現象，有時因蒸氣過濃，聚集在爐內，凝結成水並溢出，這是正常的。

微波能量能從爐門屏觀察窗嚮外泄漏嗎？

不能，金屬屏障將微波能量反射回爐內。觀察窗只允許光線通過，微波無法通過。

如果在沒有放入食物的情況下啓動微波爐會損傷微波爐嗎？

是的，決不要這樣做。

為什麼烹調結束後需擱置？

擱置幾分鐘很重要。微波烹調使食物集聚熱量，在從爐中取出食物之後，食物內部要繼續加熱2-3分鐘，擱置可使食物關節部分、大塊蔬菜或糕點在爐外進行徹底烹調。

為什麼我的微波爐烹調食物不像說明書說的那樣快？

檢查使用說明，看看是否完全遵守指令，查明設定不同時間的原因。烹調時間的設定只作參考，爲防止過度烹調，要掌握微波烹調技巧。食物的體積、重量、形狀對烹調時間都有影響。電壓低於210V，加熱慢；爐門關閉不到位或電壓低於190V，不加熱。以指令作爲參考，靈活掌握。

為什麼有時烹調時會發生閃電和清脆的響聲？

- 原因有以下幾點：
1. 使用了含金屬成分的餐具（包括金、銀）；
 2. 將叉子或其他金屬用具遺忘在爐內；
 3. 使用過多的金屬箔；
 4. 使用金屬絲捆綁食物。

為什麼微波爐工作時會發出“嗡嗡”的聲音？

微波爐工作時高壓變壓器以及風扇正常工作時發出的聲音屬於正常現象，請放心使用。

為什麼不用擔心微波泄漏？

微波泄漏量國家標準爲5mW/cm²，海爾現場生產控制遠低於國家標準。

爐門有一定晃動會引起微波泄漏嗎？

不會。

微波爐工作時有風、燈光或氣味出來會引起微波泄漏嗎？

不會，這屬於正常現象。

Contents

Parts and Accessories	1
Technical Specifications	1
Safety Precautions	2
Unpacking • Installing • Placement	2-3
Control Panel	3
Use Your Oven	3
How to Select Cooking Utensils	4
Tips for Microwave Cooking	5
Maintenance • Repair	5
Questions & Answers • After-sale Services	6

Parts and Accessories

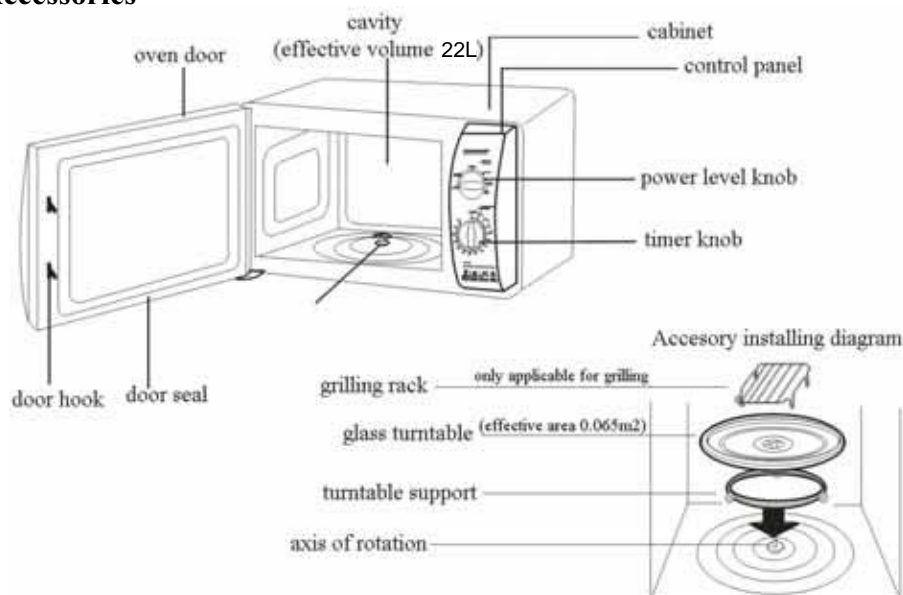

Circuit Diagram

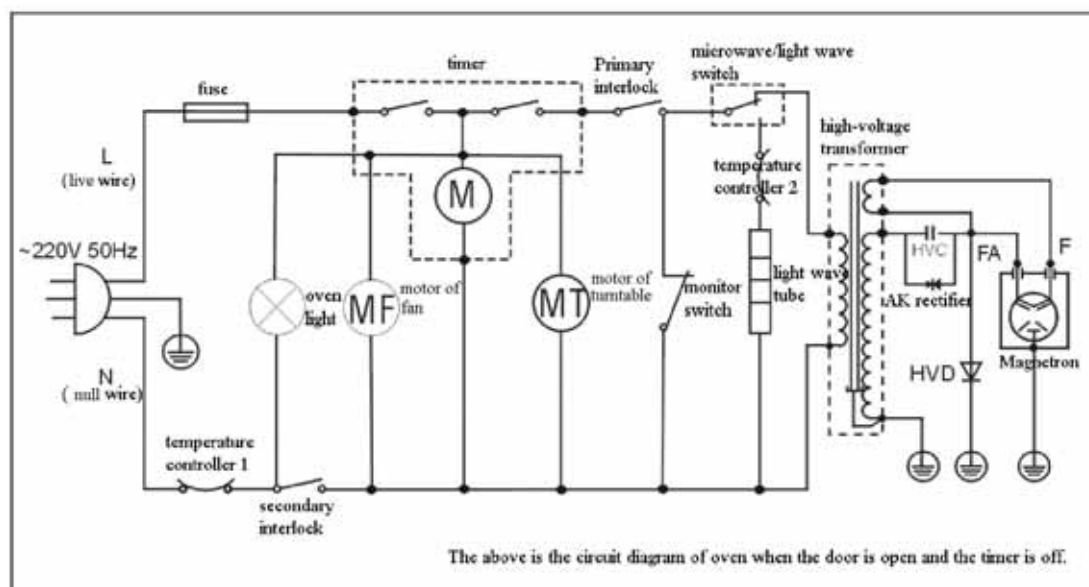

Technical Specifications

Model	Power voltage (V/Hz)	Input (W)	Output (W)	Grilling power (W)	Microwave frequency (MHz)	Cavity volume (L)	Outside dimensions (H x W x D)	Effective cavity dimensions (H x W x D)
MO-2270MG	~220/50	1200	700	950	2450	22	288x486x370	196x311x312
MM-2270MG	~220/50	1200	700	950	2450	22	288x486x380	196x311x312
MI-2270MG	~220/50	1200	700	950	2450	22	288x486x376	196x311x312
MK-2270MG	~220/50	1200	700	950	2450	22	288x486x370	196x311x312

Please note that the dimensions and volume are estimated values. Due to the continuous improvement, the technical specifications may be different from the above table, which will not be informed separately.

Safety Precautions:

• Please read the safety precautions thoroughly for safe and convenient usage of Haier microwave oven.

1. Do not put metal stick into the interlock hole at the front side of cavity. It may cause microwave leakage!
2. Do not add excessive force to the opposite direction on the door. It may deform the door and cause microwave leakage!
3. Do not use enclosed container in cooking. For food with skin, remember to puncture it before cooking.
4. Remove the grease remained in the cavity before cooking. Combustible cookware like plastic container is not recommended, as it may cause smoke or fire in heating. Please keep an eye on the oven during cooking. Do not leave for a long time.
5. After cooking is finished, take care when opening the container or removing the cover film. It may emit hot vapor and cause scalding!
6. Do not use metal container in cooking. It may ignite!
7. Do not touch the view window and the upper part of the cabinet to avoid scalding.
8. If the cavity is under high temperature (e.g. after cooking), do not use the oven immediately. Please wait for it cooling down before next usage.

- Warning: if the door or door seal is damaged, DO NOT use it until it is repaired by proper qualified maintenance personnel.
- Warning: No one except the proper qualified maintenance personnel shall make inspection and maintenance, including operations like dismantling the protective cover that prevents microwave energy from leaking.
- Warning: DO NOT cook liquid or food within enclosed container. It may cause explosion!
- Warning: Children are not allowed to use the microwave oven without supervision, unless they have received sufficient instructions enough to use the oven with safe method, and understand that improper method can result in danger.
- Use only cookware applicable for microwave inside the oven.
- When cooking food packed with plastic or paper, please keep an eye on the oven because there's a chance to ignite.
- If smoke should occur, pull off the power plug immediately and close the door of oven to control the spreading of fire.
- The beverage heated with microwave oven may delay in boiling or splashing. Please take care of it when taking out the beverage.
- Feeding bottles and baby food cans shall be stirred or shaken. Please check the temperature of the food inside the bottle to avoid scalding.
- DO NOT cook fresh or boiled eggs with shell, as they may burst during heating or even after heating, unless you use certain container as accessory of the oven (such as the steam pot).
- DO NOT operate the microwave oven when it is empty. No-load operation will damage the oven.
- DO NOT place combustible materials near the microwave oven. Please keep an eye on the cooking during operation, and set proper cooking time. Overcooking may cause fire.
- Light food with little water may be uneven in heating, as different materials have different capability in absorbing microwave.
- Do not perform defrost immediately after grilling or long-time heating with microwave. Please wait for the cooling down of the glass turntable.
- DO NOT pierce the mesh of the oven door. It may cause microwave leakage! Do not use sharp items to clean the glass turntable.



DO NOT use the product for industrial and commercial purpose!

Unpacking • Installing • Placement

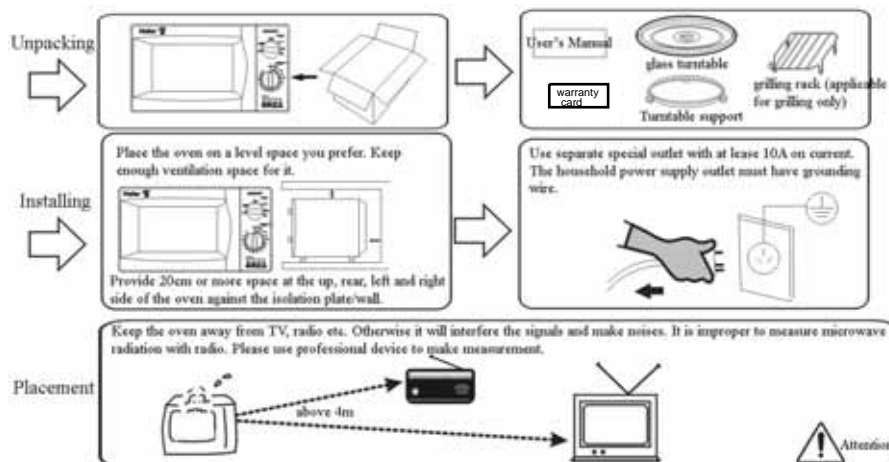

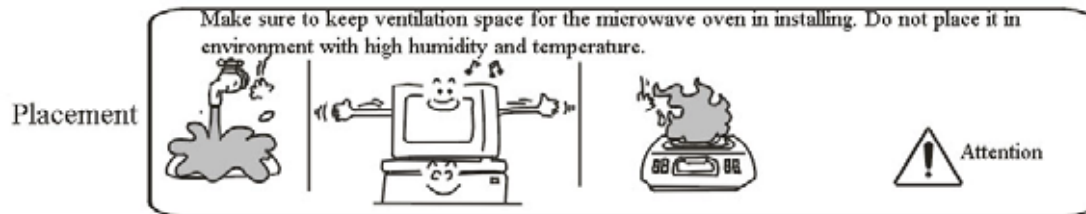

Control Panel

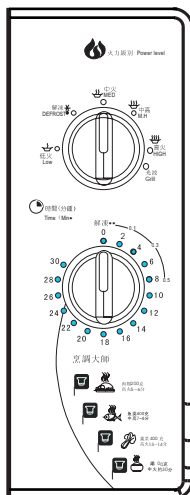

1. "Power level" knob: use it to adjust the power level and cooking method as per your requirement.
2. "Time (min)" knob (max 30min): use it to set desired cooking time.

Description of microwave power level

Low: output power 120W M.H.: output power 540W

Defrost: output power 230W High: output power 700W

Med: output power 380W Grill: output power 950W

You can refer to the "suggested cooking guide" at the lower part of control panel for your cooking.

Use Your Oven

Set cooking power level and time by "power level" knob and "time (min)" knob.

> Put the food into suitable container. Open the door, place the container at the center of turntable and close the door.

> Turn the "power level" knob to select suitable power level according to the cooking requirement. Turn the "time (min)" knob clockwise to set the cooking time.

Attention: Once the cooking time is set, the microwave oven will start operating. If the set time is less than 2 minutes, first set it to position exceeding 2 minutes, and then turn it back to desired time.

> If you open the door during cooking, the oven will stop operating. The oven light will glow. If you close the door, the oven will continue cooking. When cooking time is up, the oven will remind you with a beep, and stop operating. The cooking is finished.

> In light-wave grilling, it is suggested to open the door and turn over the food at half time of grilling.

> In grilling, please put the food evenly on container like heatproof ceramic dish or glass dish, and then place the container at the center of glass turntable. DO NOT touch the cavity.

> In defrosting, turn the "power level" knob to "defrost", and then turn the "time (min)" knob clockwise to set suitable defrosting time. The defrosting time is decided by the weight of food:

i.e. 0.1kg food needs 3 minutes; 0.3kg food needs 5 minutes; 0.5kg food needs 8 minutes.

You can also refer to the cooking guide printed at the lower side of control panel for your cooking.

Attention: In usage of grilling microwave oven, DO NOT make the power cord contact the light-wave tube at the upper side of cabinet. It may cause softening and deforming of power cord and result in safety problems!

How to Select Cooking Utensil

Selection of the microwave cooking utensil

Please select suitable cookware for the microwave oven

The features of microwave



absorbed by food



passing through glass



reflected by metal

Container type	Microwave	Grilling
Heatproof glass container	√ Applicable	√ Applicable
Non-heatproof glass container	× Not applicable	× Not applicable
Heatproof plastic container	√ Applicable . Please use containers with “microwave-safe” mark.	× Not applicable
Non-heatproof plastic container	× Not applicable . Containers that may be deteriorated by microwave are not applicable. . Foam tray can only be utilized in defrosting fresh food.	× Not applicable
Ceramic container	√ Applicable . Ceramic containers with color pattern or decoration of gold and silver are not applicable.	√ Applicable . Ceramic containers with inner color pattern may drop colors. Thus it is not recommended to use.
Lacquer ware	× Not applicable . It may drop lacquer or break.	× Not applicable
Metal container made by aluminum etc.	× Not applicable . It may cause arcing by metal net or rack, therefore is not applicable. . Coloring plate (metallic product) for microwave oven is not applicable either. . Steam cookware for microwave oven is applicable.	√ Applicable . If the handle of container is made of resinous material, the container is not applicable.
Wooden, bamboo and paper container	× Not applicable . It may ignite.	× Not applicable . Paper products processed with heatproof technology are applicable.
Preservative film and heatproof PE bag	√ Applicable . It is not applicable in greasy cooking (such as cooking meat and fried food) because the cooking may produce high temperature.	× Not applicable . It may melt under high temperature.
Aluminum foil	× Not applicable . Sometimes it can be utilized in defrosting.	√ Applicable . Wrap the food with aluminum foil to do grilling.

Remarks: After cooking is finished, do not wash the glass turntable with cold water. It may cause broken of the turntable! Please wait till the turntable is cooling down naturally.

Tips for Microwave Cooking

Tips for microwave cooking

Food temperature	The lower the food temperature is, the longer the cooking time will cost. The frozen food generally costs longer time than the common food.
Food humidity	Humid food absorbs more microwave energy. Thus the higher the food humidity is, the shorter the cooking time costs.
Food shape	The microwave can only pass through the food for 2-4cm under surface. Therefore the thickness of the food will influence the heating time.
Food density	Different density requires different heating time. Food with high density will cost longer cooking time.
Food quantity	The microwave energy is fixed and will not change with the quantity of food. Therefore large quantity of food will cost long cooking time.
Bones and fat	Bones can transfer heat faster than common food. Fat can absorb more microwave energy. Therefore please pay attention to overheating on certain part when you cook meat with bones and fat.
Cover	It will reduce losses of heat and vapor by putting the food into container with cover, and thus will shorten the cooking time.
Placement	Place the food in circular shape and avoid piling up. It can improve the evenness during cooking.
Stirring	In heating liquid food like soup, juice or beverage, please stir the liquid both before and halfway during heating. It can effectively prevent the liquid from boiling and splashing.
Sealing	Sealing the food with preservative film can prevent the liquid from splashing and soiling the cavity. It can also keep the moisture and nutrition of the food.
Standing	After cooking is finished, the food taken out of the oven is still being heated inside. Considering of the flavor and cooking degree, you can give it some standing time.

Maintenance • Repair

Maintenance: Periodical maintenance and cleaning can guarantee the normal operation of microwave oven.

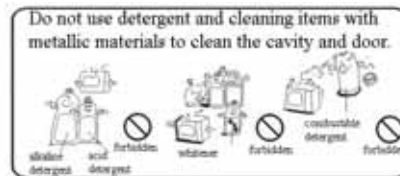
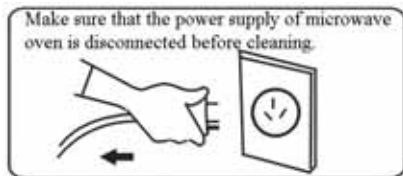

Use soft cloth and neutral soapy water to clean the cabinet, and wipe it with soft dry cloth.

Use humid cloth to clear the food scrap on the door, door seal and inside the cavity. Use wet cloth and soapy water to clear the greasy stain.

Keep the inner side of the door clean. Remove any food residue as it may cause igniting, smell or rusty spot inside the cavity, and corrode the axis of rotation.

Please take it out and wash with soapy water at least once a week to prevent the grease from corroding the axis of rotation.

If the power supply cable is damaged or faulty, make sure to have it replaced by the professional maintenance personnel of the manufacturer or after-sale services department.

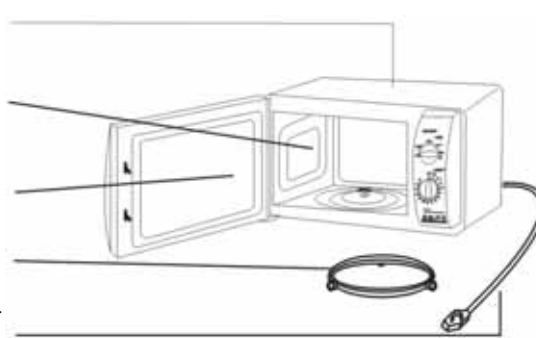

Remarks: If the microwave oven is idle for a long time, please clean the water stain and greasy stain that may remain on each part of the oven, and place it in dry environment with good ventilation to avoid rusting.

Warning If the microwave oven has abnormal operation or is damaged, DO NOT use it any more before it is repaired by professional maintenance technicians

Questions & Answers

Questions & Answers

Why doesn't the oven light glow?	<ol style="list-style-type: none"> 1. The oven light is faulty. 2. The timer is not set.
Why doesn't the oven operate?	<ol style="list-style-type: none"> 1. The power supply is off. 2. The outlet for the oven is faulty. 3. The door is not closed completely, thus the safety system prevents the power supply from switching on.
Why does the oven start with a sound like striking?	It is a normal sound indicating that the transformer starts operating under high voltage and frequency.
Why does the oven make large noises in operating?	<ol style="list-style-type: none"> 1. The turntable support is defective. 2. The glass turntable has malposition. 3. The transformer, magnetron and high-speed venting fan will make sound during operation, and there may be resonant sound.
The heating is slow, or does not work?	<ol style="list-style-type: none"> 1. The power supply is off. 2. The heating function is not set during function setting.
Why does vapor come out of the air discharge outlet? Why does water flow out below the door?	It is normal that the vapor may appear during cooking. Sometimes the vapor is too thick and gathered inside the oven, and finally condensed into water which may flow out. It is normal phenomenon.
Does microwave energy pass through the view window on the door?	No. The metal shield will reflect the microwave energy back to the oven. The view window only allows harmless light to pass through. The microwave can not pass through it.
If the oven is started without food, will it be damage?	Yes. NEVER do that.
Why is standing time recommended after microwave cooking is over?	It is important to give the food several minutes for standing time. Food cooked with microwave oven gathers heat inside. After you take out the food from the oven, the food will continue heating inside for 2-3 minutes. It can evenly and completely cook the jointer of the food, big block of vegetables or cookies outside the oven.
Why doesn't my oven always cook as fast as the cooking guide says?	Check your cooking guide again to make sure you've followed directions correctly, and to see what might cause variations in cooking time. Cooking guide times are only suggestions. To prevent overcooking, you should learn the cooking tips with microwave oven. Variations in the size, shape, weight and dimensions of the food require different cooking time. If the voltage is below 210V, the heating will be slow; if the door is not closed completely or the voltage is below 190V, the heating will not work. Please use the cooking guide as reference along with your own judgment.
Why is there arcing or cracking sound during cooking sometimes?	<p>It may be caused by following reasons:</p> <ol style="list-style-type: none"> 1. Cookware has metal part (including gold and silver); 2. Fork or other metal dishware are left in the oven; 3. Too many metallic foil are used; 4. Metallic thread is used to bind the food.
Why does the oven make humming sound during operation?	It is the sound made by high-voltage transformer and fan during operation. It is normal phenomenon and has no influence on your safe usage of the oven.
Why should I rest assured on microwave leakage?	The national standard of microwave leakage is $5\text{mW}/\text{cm}^2$. The field control value of Haier is by far lower than the national standard.
The door can be slightly swayed. Will it cause microwave leakage?	No.
The oven may give off vapor, light or smell during operation. Will it cause microwave leakage?	No. It is normal phenomenon.



Specific No.0050502452A

Free Manuals Download Website

<http://myh66.com>

<http://usermanuals.us>

<http://www.somanuals.com>

<http://www.4manuals.cc>

<http://www.manual-lib.com>

<http://www.404manual.com>

<http://www.luxmanual.com>

<http://aubethermostatmanual.com>

Golf course search by state

<http://golfingnear.com>

Email search by domain

<http://emailbydomain.com>

Auto manuals search

<http://auto.somanuals.com>

TV manuals search

<http://tv.somanuals.com>