

Haier

TFT-LCD COLOUR TELEVISION RECEIVER

OWNER'S MANUAL

This User's Manual is applicable for the following models:
L32A9-AK, L32A9-AK, L32A9⁺-AK, L32A9-AKF

Please read this manual carefully
before operating the unit, and keep
it for future reference.

Haier

Congratulations on your purchase, and welcome to the "family"!

Dear Haier product owner:

Thank you for your confidence in Haier. You've selected one of the best-built, best-backed products available today. We'll do everything in our power to keep you happy with your purchase for many years to come.

As a member of the Haier "family," you're entitled to protection by one of the most comprehensive warranties and outstanding service networks in the industry.

thanks for investing in a Haier product.

CONTENT

BEFORE OPERATING

Warning.....	1
Important Safety Instructions.....	2
Buttons and interface location.....	4
Remote controller.....	6
Remote controller key function.....	7
Effective range of remote controller.....	8
External equipment connections.....	9

BASIC OPERATING

Switching on/off the TV set.....	14
Select input modes	15
Searching channel.....	16
Watching TV program.....	18
Picture control functions.....	21
Sound control functions.....	23
Time functions.....	26
Function menu.....	28
Adjust menu.....	29
Lock setup.....	32

OTHERS

Others functions.....	35
Stream media broadcast system.....	37
Specifications and functions.....	47
Maintenance.....	48
Troubleshooting.....	49

Warning



WARNING



WARNING

TO REDUCE THE RISK OF ELECTRIC SHOCK DO NOT REMOVE COVER (OR BACK). NO USER SERVICEABLE PARTS INSIDE. REFER TO QUALIFIED SERVICE PERSONNEL.

*To avoid electric hazards, it is strongly suggested that the back cover not be opened, as there is no any accessory inside the casing.

*If necessary, please contact authorized after-sales services.

*A lightning flash mark in a triangle: A potentially hazardous situation, which, if not avoided, could result in serious injury by high voltage.

*An exclamation mark in a triangle: Major part or accessory of which technical specifications must be followed if it is to be replaced.

Warning:

To avoid fire or electric hazards, never place your television receiver in an area with heavy moisture. Attention should be paid to avoid accidental scratches or impacts onto the LCD screen.

Caution:

- ▲ Please read this manual carefully before using your television and keep this manual in a good place for future reference.
- ▲ To achieve the best performance of your television, read this User's Manual carefully and properly store it for future reference.
- ▲ Information of screen displays and figures in the User's Manual may vary due to technical innovations.

Caution:

Unauthorized disassembly of this product is prohibited.

Important Safety Instructions

The product should be tightly fixed to avoid drop damages and even fire.

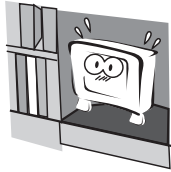

To avoid fire hazards, do not use this product under direct sunlight or closely to heat sources.

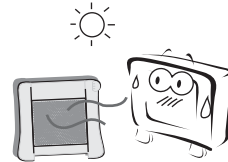

Do not locate the product close to water or oil, which may cause fire hazards.

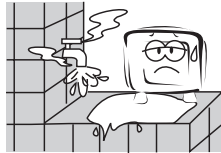

Unplug the power supply and antenna of the product when there is a rainstorm, especially Thunderstorm.

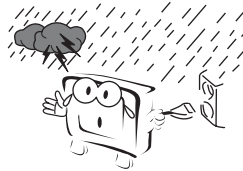

Do not use damaged or worn electric plugs, and keep electric cord away from heat sources to avoid electric shocks or fire hazards.



Do not connect excessive sockets in parallel or share the same socket by multiple plugs to avoid fire hazards.

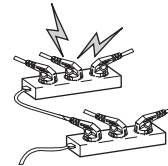

The product must be placed on a solid and stable surface to avoid collapse.

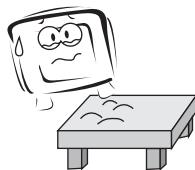

Unauthorized disassembly of the television is prohibited to avoid electric shocks or fire hazards. Contact authorized after-sales service if technical service is needed.

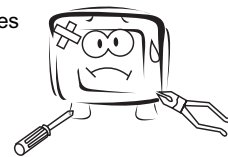

Keep the product away from a transformer or heat source to avoid fire hazards.

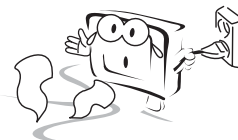
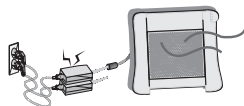

Disconnect the product from power supply and contact authorized after-sales service if abnormal sound is heard in the product.

Buttons and interface location

- This is a simplified representation of front panel.
- Here shown may be somewhat different from your TV.

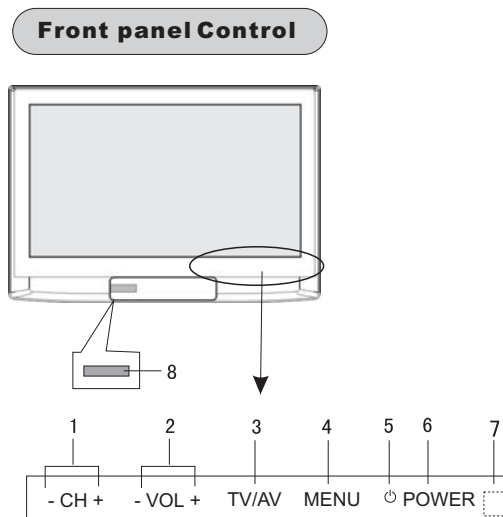

Buttons and functions

- 1、CH-/+ : program minus and plus , menu options
- 2、VOL-/+ : volume decrease and increase , menu reset and entry
- 3、TV/AV: all input source select:TV-VIDEO-SIDE VIDEO-S VIDEO-YUV-USB-VGA-DVI
- 4、MENU: menu display
- 5、Power on/off and indicator: in red when standby mode, in blue when display.
- 6、POWER : AC power on/off
- 7、Remote control signal receive window
- 8、Multi-media input

Buttons and interface location

Rear panel Control

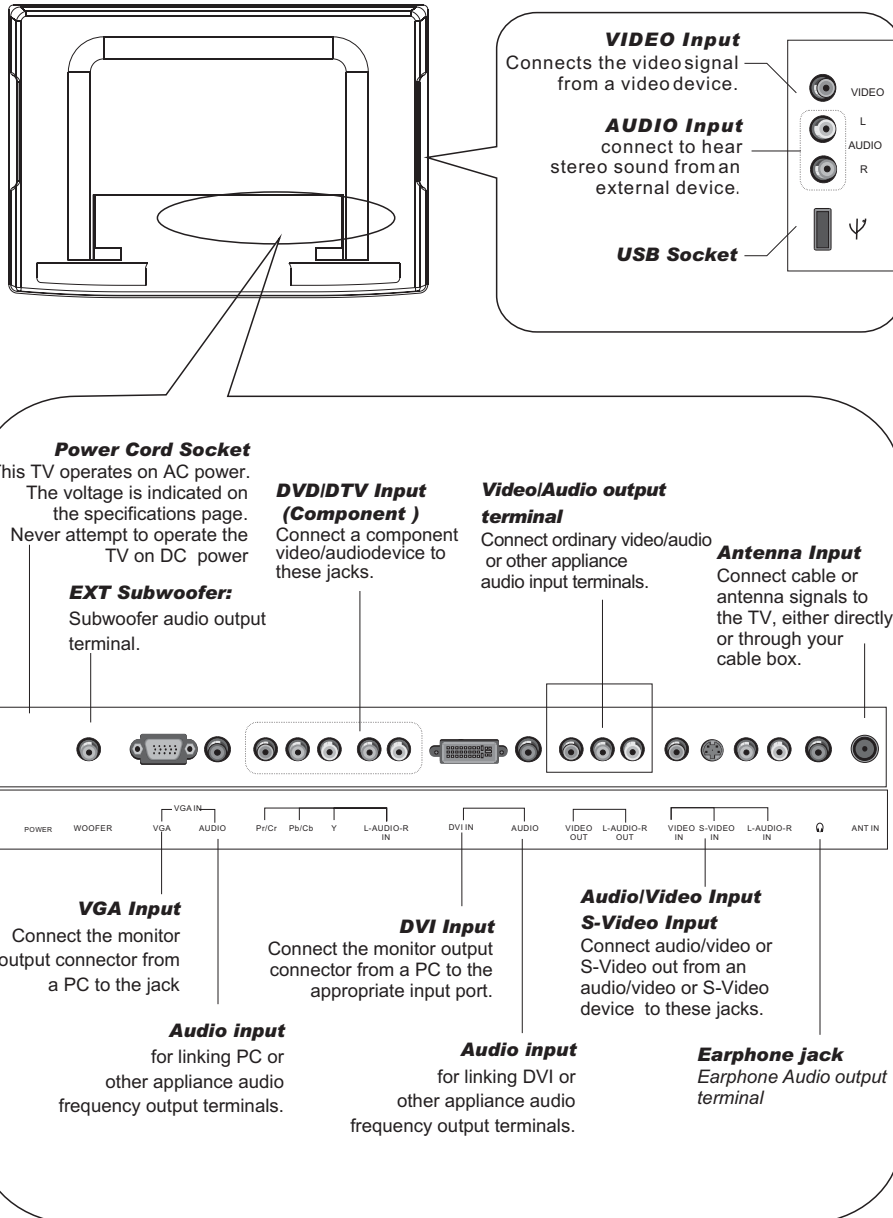

Remote controller

Battery loading

1. Slide open the cover of the battery compartment on the back of the remote controller.
2. Load two 7# (AAA) alkaline batteries in the compartment. (plus and minus poles to respective mark)
3. Replace the cover of the battery compartment.

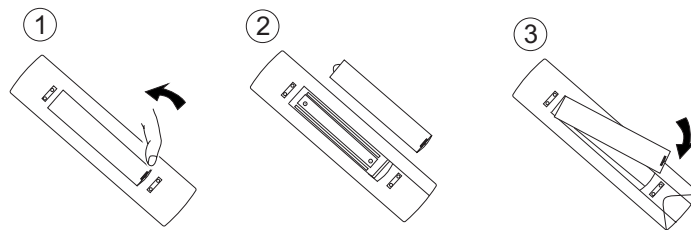

Precautions

As strong light may interfere the signals, change your position to operate the remote controller if the television cannot be turned on or off as you expect.



Make sure that two AAA alkaline batteries are loaded. The batteries must be of the same type. The batteries must be located properly. The batteries are not rechargeable.

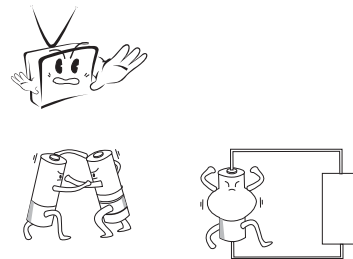

Keep the remote controller away from heat source or humid area to ensure effective performance of the remote controller.

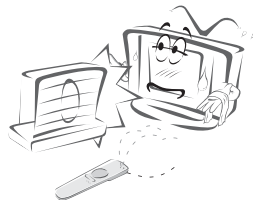

Make sure that there is no obstacle between the remote controller and television set.

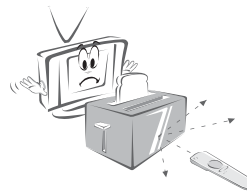

⑥

Remote controller key function

The remote controller cannot be operated unless the batteries are properly loaded.

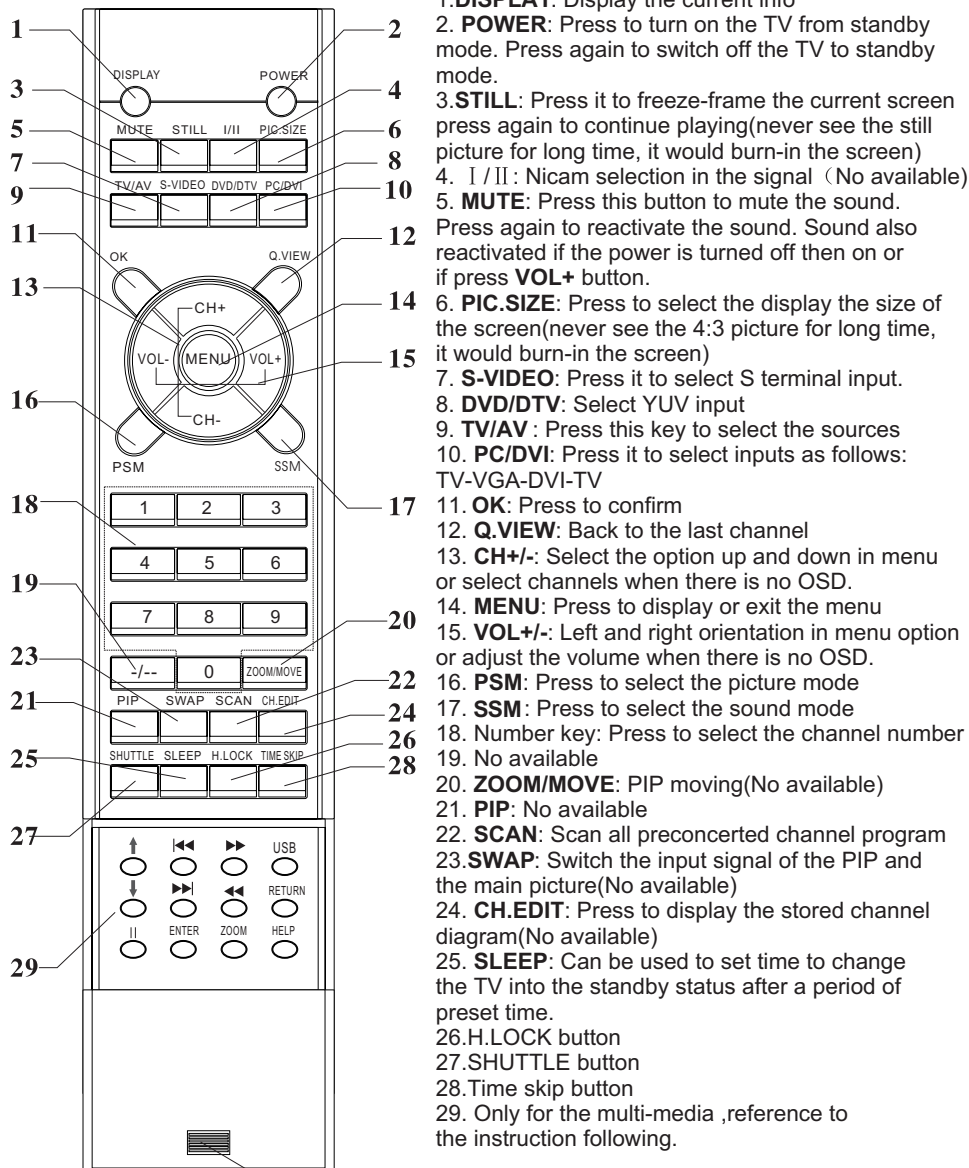

1. **DISPLAY**: Display the current info
2. **POWER**: Press to turn on the TV from standby mode. Press again to switch off the TV to standby mode.
3. **STILL**: Press it to freeze-frame the current screen press again to continue playing(never see the still picture for long time, it would burn-in the screen)
4. **I / II**: Nicam selection in the signal (No available)
5. **MUTE**: Press this button to mute the sound. Press again to reactivate the sound. Sound also reactivated if the power is turned off then on or if press **VOL+** button.
6. **PIC.SIZE**: Press to select the display the size of the screen(never see the 4:3 picture for long time, it would burn-in the screen)
7. **S-VIDEO**: Press it to select S terminal input.
8. **DVD/DTV**: Select YUV input
9. **TV/AV**: Press this key to select the sources
10. **PC/DVI**: Press it to select inputs as follows: TV-VGA-DVI-TV
11. **OK**: Press to confirm
12. **Q.VIEW**: Back to the last channel
13. **CH+/-**: Select the option up and down in menu or select channels when there is no OSD.
14. **MENU**: Press to display or exit the menu
15. **VOL+/-**: Left and right orientation in menu option or adjust the volume when there is no OSD.
16. **PSM**: Press to select the picture mode
17. **SSM**: Press to select the sound mode
18. Number key: Press to select the channel number
19. No available
20. **ZOOM/MOVE**: PIP moving(No available)
21. **PIP**: No available
22. **SCAN**: Scan all preconcerted channel program
23. **SWAP**: Switch the input signal of the PIP and the main picture(No available)
24. **CH.EDIT**: Press to display the stored channel diagram(No available)
25. **SLEEP**: Can be used to set time to change the TV into the standby status after a period of preset time.
26. **H.LOCK** button
27. **SHUTTLE** button
28. Time skip button
29. Only for the multi-media ,reference to the instruction following.

Note: The cover of the multi-media keys press down to the appropriate position

The function just takes the remote control for example in this manual P+/--(CH+/-),V+/--(VOL+/-),MENU,TV/AV and POWER on TV panel are corresponding with the CH+/-,VOL+/-,MENU,TV/AV and POWER keys.

Effective range of remote controller

Effective range

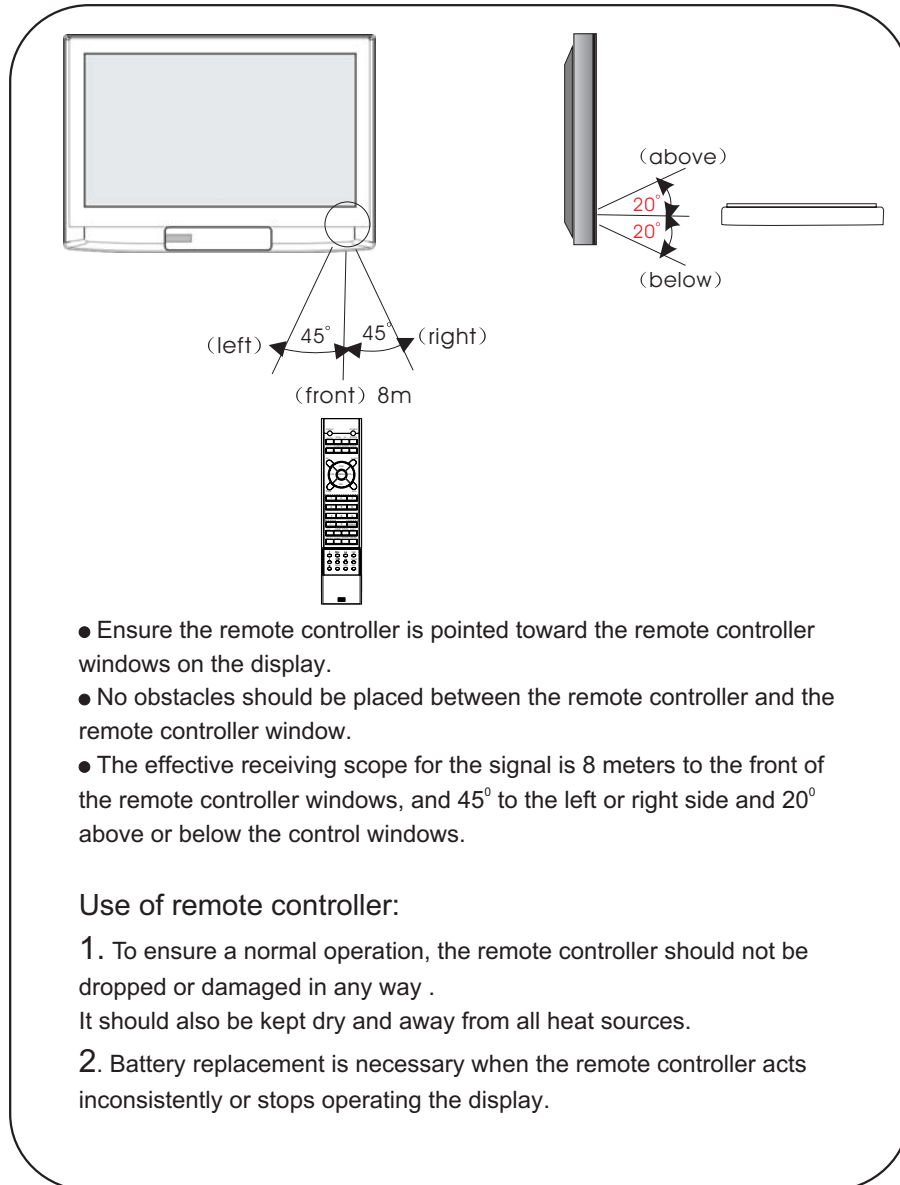

External Equipment Connections

Antenna Connection

- Antenna or Cable Service without a Cable Box Connections
- For optimum picture quality, adjust antenna direction if needed.

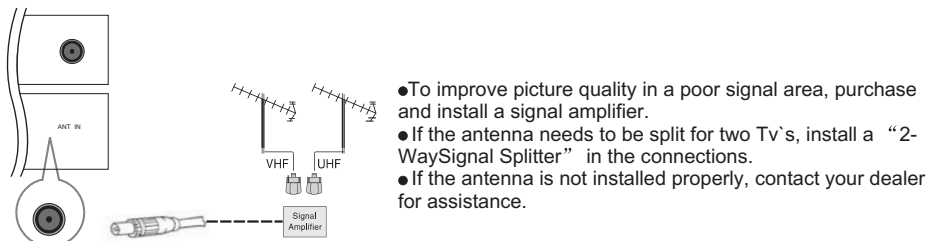
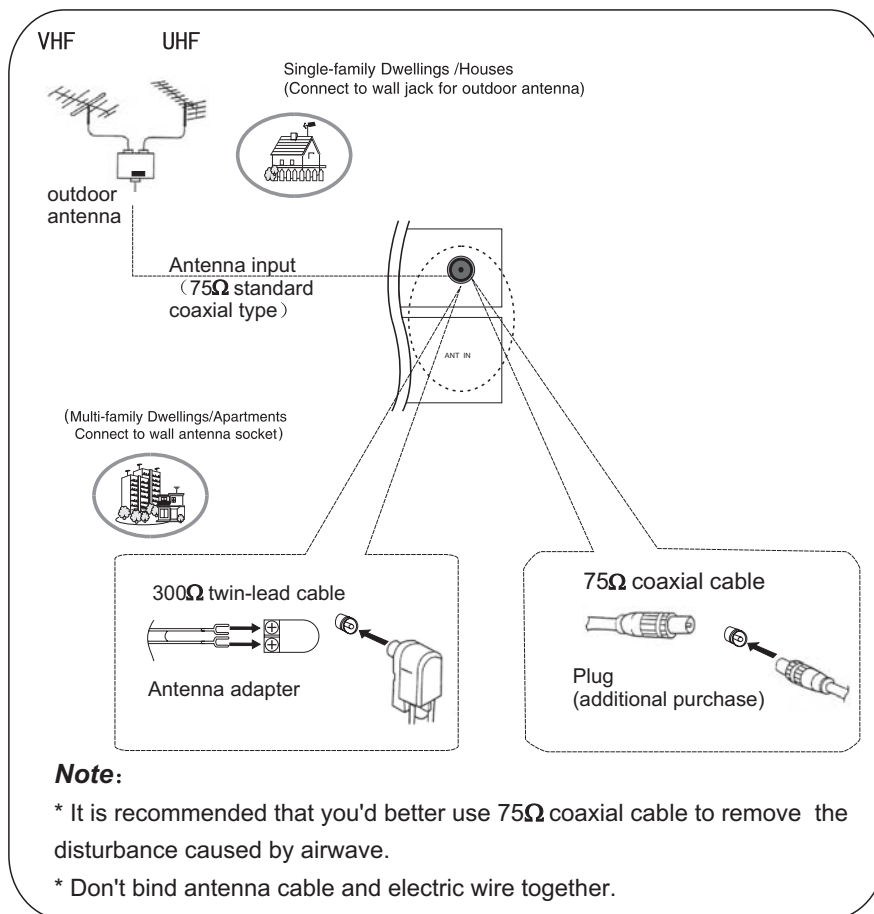

External Equipment Connections

DVD setup

How to connect

1. Connect the DVD video outputs (Y, Pb/Cb, Pr/Cr) to the COMPONENT (Y, Pb/Cb, Pr/Cr) INPUT jacks on the TV and connect the DVD audio outputs to the AUDIO INPUT jacks on the TV, as shown in the figure.

2. If your DVD only has an S-Video output jack, connect this to the S-VIDEO input on the TV and connect the DVD audio outputs to the AV IN jacks on the TV, as shown in the figure.

NOTE: If your DVD player does not have component video output, use S-Video.

How to use

1. Turn on the DVD player, insert a DVD.
2. Use the S-Video button on the remote control to select S-VIDEO mode.
3. Press Play button on external equipment for program play.
4. Refer to the DVD player's manual for operating instructions.

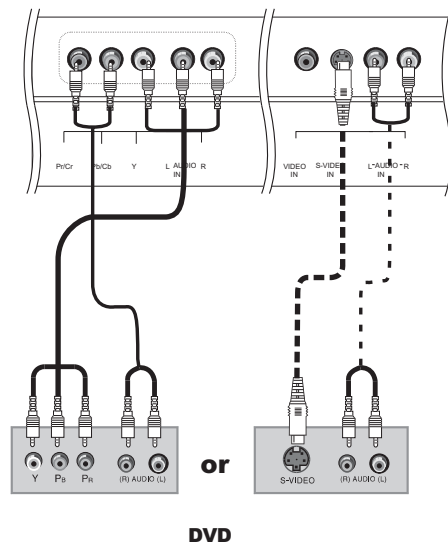

DTV setup

-To watch digitally broadcast programs, purchase and connect a digital set-top box.

How to connect

Use the TV's COMPONENT (Y, Pb/Cb, Pr/Cr) INPUT jacks, VGA or DVI port for video connections, depending on your set-top box connections available. Then, make the corresponding audio connections.

How to use

1. Turn on the digital set-top box. (Refer to the owner's manual for the digital set-top box.)
2. Use PC/DVI on the remote control to select PC or DVI (Y, Pb/Cb, Pr/Cr) mode.
3. Press Play button on external equipment for program play.

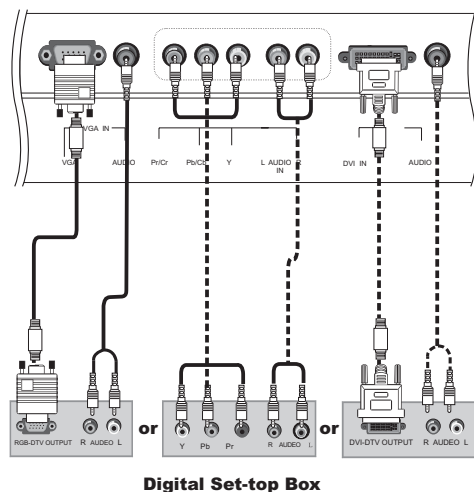

External Equipment Connections

PC setup

How to connect

1. Use the TV's VGA IN or DVI (Digital Visual Interface) IN port for video connections, depending on your PC connector.

- If the graphic card on the PC does not output analog and digital RGB simultaneously, connect only one of either VGA IN or DVI INPUT to display the PC on the TV.

- If the graphic card on the PC does output analog and digital RGB simultaneously, set the TV to either VGA or DVI; (the other mode is set to Plug and Play automatically by the TV.)

2. Then, make the corresponding audio connection. If using a sound card, adjust the PC sound as required.

How to use

1. Turn on the PC and the TV.

2. Turn on the display by pressing the POWER button on the TV's remote control.

3. Use PC/DVI on the remote control to select PC or DVI source.

4. Check the image on your TV. There may be noise associated with the resolution, vertical pattern, contrast or brightness in PC mode. If noise is present, change the PC mode to another resolution, change the refresh rate to another rate or adjust the brightness and contrast on the menu until the picture is clear. If the refresh rate of the PC graphic card can not be changed, change the PC graphic card or consult the manufacturer of the PC graphic card.

NOTES:

1、 Use a DVI cable.

2、 Avoid keeping a fixed image on the TV's screen for a long period of time. The fixed image may become permanently imprinted on the screen.

3、 The synchronization input form for Horizontal and Vertical frequencies is separate.

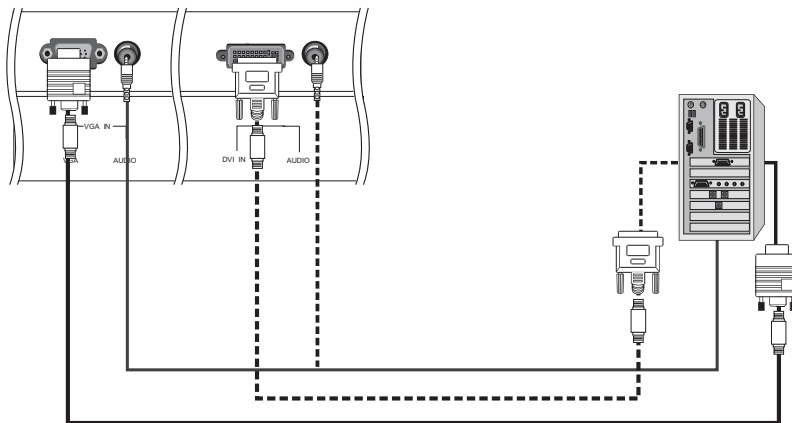

External Equipment Connections

Connect Woofer

1. Take the woofer out, and place it the hindrind. (See picture)
2. Connect cable to the woofer terminal and LCD TV terminal, and insert the connecting cable into the terminal slot.



External Equipment Connections

Connecting Headphones

You can connect a set of headphones to your set if you wish to watch a TV programme without disturbing the other people in the room.

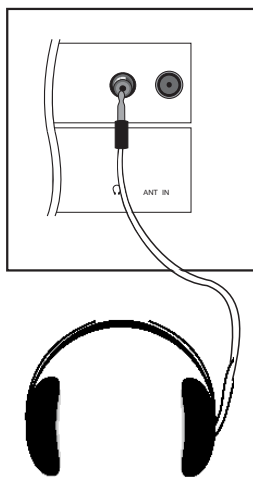

Plug a set of headphones into the 3.5mm mini-jack socket on the rear panel of the set.

Note:

- Prolonged use of headphones at a high volume may damage your hearing.
- You will not receive sound from the speakers when you connect headphones to the system.

Power source

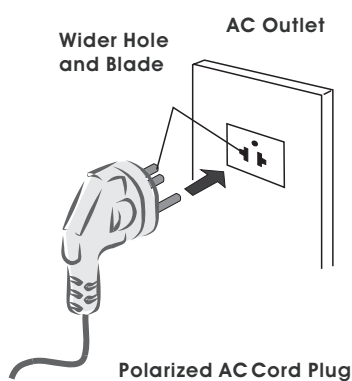

TO USE AC POWER SOURCE

Use the AC polarized line cord provided for operation on AC. Insert the AC cord plug into a standard polarized AC outlet.

NOTES:

- Never connect the AC line cord plug to other than the specified voltage. Use the attached power cord only.
- If the polarized AC cord does not fit into a non-polarized AC outlet, do not attempt to file or cut the blade. It is the user's responsibility to have an electrician replace the obsolete outlet.
- If you cause a static discharge when touching the unit and the unit fails to function, simply unplug the unit from the AC outlet and plug it back in. The unit should return to normal operation. Polarized AC Cord Plug.

Switching ON/OFF the TV set

In the manual, the OSD (on screen display) may be different from your TV's because it is just an example to help you with the TV operation.

Power ON/OFF

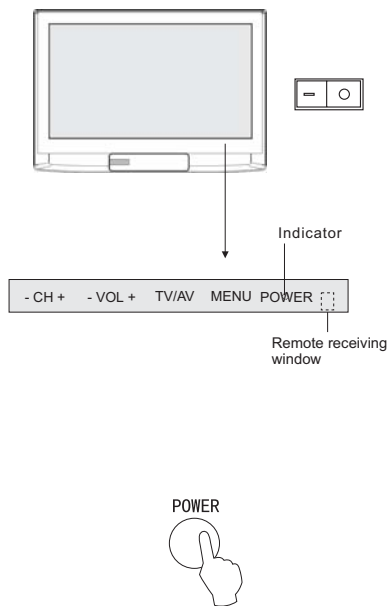

Switching ON/OFF the TV set

- 1 Please press down the power switch to switch on AC power supply and the power indicator will light .
- 2 If the indicator is lighting in red, press **POWER** button on the remote control again.
- 3 If you want to exchange to standing by status, please press down **POWER** button on the remote controller.
- 4 If you want to fully switch off the power supply for the TV set, please press down the power switch button on the TV set.

Choose the Menu Language

When you start using your set for the first time, you must select the language which will be used for displaying menus and indications.

- 1 Press **MENU** and **VOL+/-**-button to select the **FUN.** Menu.
- 2 Press **CH+/-**-button to select **Language**.
- 3 Select a particular language by pressing **VOL+/-** button repeatedly. You can choose one of two languages. (Chinese or English)
- 4 When you are satisfied with your choice, press **MENU** button to return to normal viewing.

Select input modes

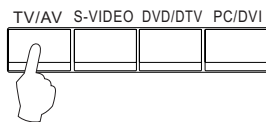

Choose the input source

If you hope to enjoy the picture from the external input source, before to select the source, you need to connect the devices, otherwise, when you select the source, the none or no signal will appears on the screen.

Press **TV/AV** button on remote controller, the menu appears on the screen. Then press **CH+/-** to select the TV item, and press **VOL+/-** to ensure it.

Source
TV
AV1
AV2
YPbPr/YCbCr
VGA
DVI
USB

TV: the input source from ANT IN terminal output.

AV1: the input source from AV1 terminal output.

AV2: the input source from AV2 terminal output.

YPbPr/YCbCr: the input source from YPbPr terminal output.

VGA: the input source from VGA IN terminal output.

DVI: the input source from DVI IN terminal output.

USB: the input source from USB socket terminal output.

Before watching TV program, you need to ensure your TV in TV mode.

Searching Channel

- This TV set has three methods to set channels, which are respectively full automatic, manual search, fine tune.
- In this section, how to use the remote control to set channel is explained. You can also use buttons on the TV set to set channel.

Full automatic search mode

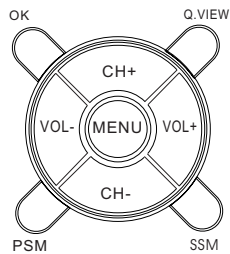

Automatic search

1 Press the MENU button and VOL+/- button, till tuning menu shown on the right display on the screen.

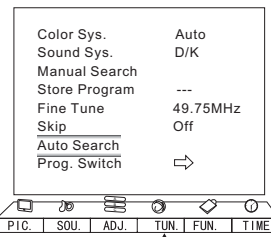

Note : the tuning menu will be only operated in normal TV mode.

2 Press the CH+/- buttons to select "Auto Search" item.

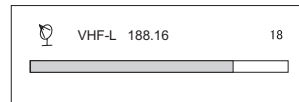

3 Press the VOL+ button to ensure automatic search function work.

After the search has finished, all channels now playing program will be automatically preset in order.

4 Press MENU button to stop automatic search function.

Searching Channel

Manual search

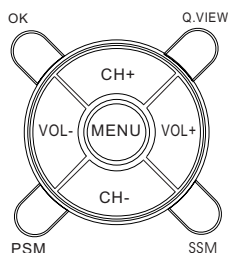
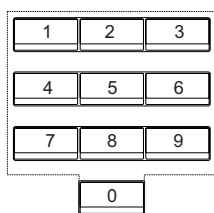

Manual search

1 Press the CH+/- buttons or the PROGRAM NUMBER (0-9) button to choose desired channels (regard channel 1 as example) .



2 Press the MENU button and VOL+/- button, till the TUN. menu shown on the right display on the screen.

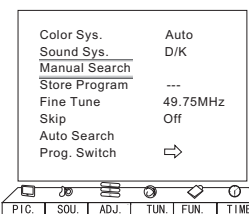

3 Press the CH+/- buttons to select " **Manual Search**" item.

4 Press the VOL-/+ buttons to start searching.

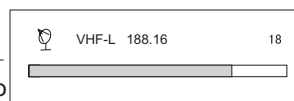

When searching successfully for the channel, the Manual search stopping automatically, at this time, press CH- button to select **Store Program**, then press VOL+/- to set the store.

Fine tune

If the picture and/or sound are poor, try using the FINE TUNE feature. Do not use this feature unless reception is poor.

1 Repeat step 1-2, then press CH+/- buttons to select " **Fine Tune**" item.

2 Press VOL-/+ buttons repeatedly to carry out fine tune, till the best picture and sound are obtained, then loosen the button.

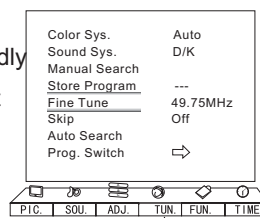

Watching TV Program

You can watch TV program in a presetting channel.

Watching TV program

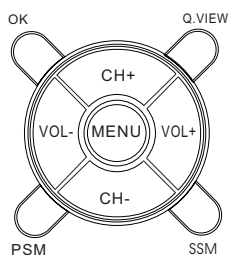
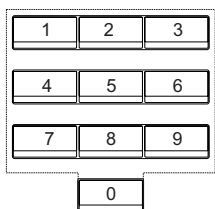
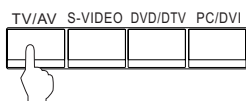

To select the TV mode

Before watching TV program, you may ensure your TV in TV mode.

Press TV/AV button to select TV mode.

How to select the desired program

1 Using "Program number" buttons.

- Directly enter the channel number with the numeric keypad on the remote control.

If to select channel numbers of double-digit or three-figure , press continuously the numeric buttons in three second.

2 Using the CH+/- buttons.

- Press the CH+ button to select a channel number in number increasing direction.

- Press the CH- button to select a channel number in number decreasing direction.

How to select the desired sound

Press the VOL-/+ buttons on the remote or the front of the TV set to adjust the volume level. The range is 0~100.

When the volume buttons are pressed the volume level is displayed automatically on the TV screen.

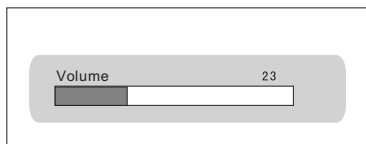

Watching TV Program (continued)

Watching TV program

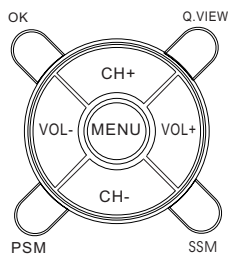
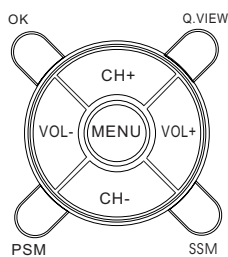

If the color of some channel is abnormal

Usually this should be set in the auto position. However if the color displayed on the screen are incorrect, you can manually select the correct color system.

Press the menu and VOL+/- button, till the picture menu shown on the right will display on the screen.

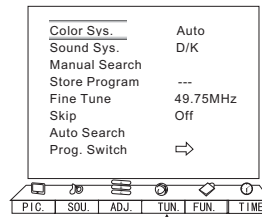

If picture color is abnormal

Press the CH+/- buttons to select "Color Sys.", then press the VOL-/+ buttons to select the correct color system. In general, you can set it as "AUTO".

If sound is abnormal

Press the CH+/- buttons to select "Sound Sys.", then press the VOL-/+ buttons to select the correct sound system. In general, you can set it as "D/K".

Skip

After the programs are presetting, you can skip some programs so that to select your favorite channels only.

1. Press CH+/- button or Direct-digit choosing button to select a channel directly (take channel 18 for example).
2. Press MENU, CH+/- and VOL+/- button, till the TUN. menu shown on the right will display on the screen.
3. Press VOL-/+ button to set Skip On.
4. Press MENU to exit.

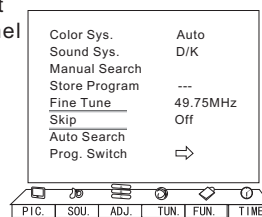

If you want to recover the skipped channel

1. Use Direct-digit Choosing button to select the number of the channel to be recovered.
2. Do the above steps again.
3. Press VOL+/- button to set Skip OFF.

Watching TV Program (continued)

Watching TV program

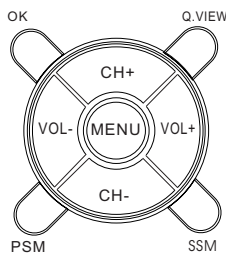

Prog. Switch

1. Press MENU, CH+/- and VOL+/- button, till the **TUN.** menu shown on the right will display on the screen.

2. Press CH+/- button to select **Prog.Switch**.

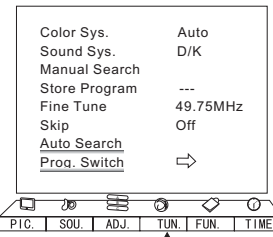

3. Press VOL+ to enter the submenu, and press the digital button to set the desired channel number, Press CH+ button to To Prog. Press the digital button to set the exchange channel number, press CH+ button to Switch, then press VOL+ button to ensure.

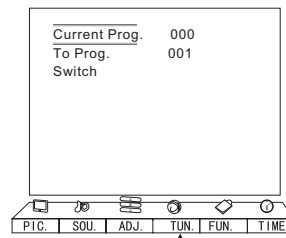

4. press MENU exit.

Quick program view

This function enables quick swap to the last watched program.

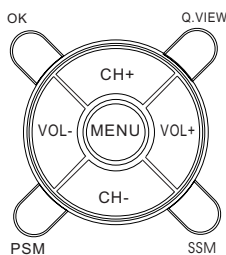

1 Suppose the channel number you used just now is 8 and the channel number you are using is 18 (as shown in the figure).

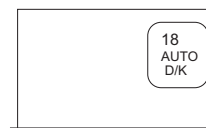

2 If you want to return to the last watched program channel 8, you can simply press the Q.View button.



3 If you want to return to channel 18, press the button again. Use this function, you can easily change between the channel you are using and the channel you used last time.

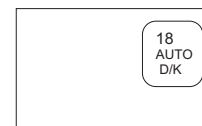

Picture Control Functions

Multiple picture modes

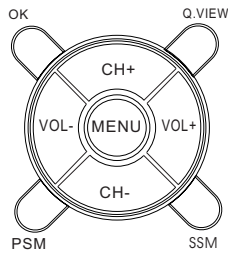

How to select picture modes

You can quickly select the desired picture mode from three preset modes and one customized mode.

Press the PSM button to select the desired picture quality. Four kinds of picture modes (i.e., "Normal", "Soft", "Personal", "Bright") can be selected in turn.

PIC. Mode
Bright
Normal
Soft
Personal

The 4 modes are

Picture mode	Picture quality
Personal	A spare setting that can be adjusted to personal tastes
Normal	Designed for rooms that have good all round lighting
Soft	Designed for nighttime low light viewing
Bright	Designed for rooms with high ambient lighting such as daytime sport;

How to customize your own picture status

1 Press the MENU button and VOL+/VOL- button, till the PIC menu shown on the right display on the screen.

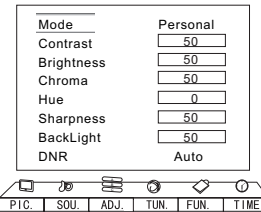

2 Press the CH+/- buttons to select the item to be adjusted, then press the VOL-/+ buttons to obtain the desired effect.

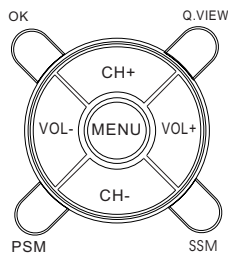
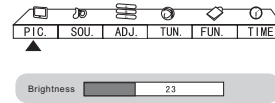

ITEM	Press VOL-	Press VOL+
Brightness	Dark	Bright
Contrast	Weak	Strong
Sharpness	Soft	Sharp
Chroma	Shallow	Deep
Hue(only in NTSC mode)	More purple	More green
BackLight	Green	Red

NOTE : these items are adjustable only under the "personal" setting.

Picture Control Functions

Multiple picture modes

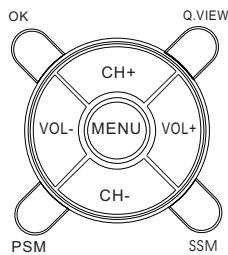

DNR(Digital Noise Reduction)

Automatically filters out and reduces the image noise and improves picture quality when receiving weak video signals.

- 1 After calling up the Picture menu, press CH+/- button to select "DNR" item.
- 2 Press VOL+ to enter the list. Select **Auto**, **Off**, **Weak**, **Medium** or **Strong** according to the image noise.
- 3 Press MENU return to the picture menu.

Mode	Personal
Contrast	50
Brightness	50
Chroma	50
Hue	0
Sharpness	50
BackLight	50
DNR	Auto

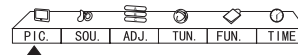

In other modes

TV/AV1/AV2/USB

Mode	Personal
Contrast	50
Brightness	50
Chroma	50
Hue	0
Sharpness	50
BackLight	50
DNR	Auto

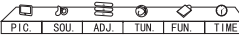

Only N system. ←

YPbPr/YCbCr

Mode	Personal
Contrast	50
Brightness	50
Chroma	50
Hue	0
Sharpness	50
BackLight	50
DNR	Auto

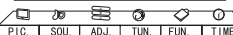

→ No adjustable

VGA/DVI

Mode	Personal
Contrast	50
Brightness	50
Chroma	50
Hue	0
Sharpness	50
BackLight	50
DNR	Auto

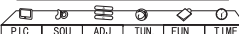

No adjustable

Sound Control Functions

Multiple sound modes

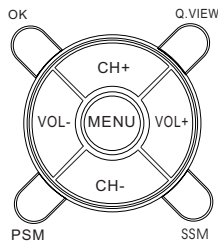

How to choose sound mode

Press the **SSM** button to select the desired sound quality. Four kinds of sound modes (i.e., “Standard”, “Theater”, “Personal”, and “Music”) can be selected in turn.

SOU. Mode
Music
Standard
Theater
Personal

Sound mode	Sound quality
Personal	A spare setting that can be adjusted to personal tastes
Standard	normal sound with moderate bass and treble setting
Music	Designed to reduce the bass and treble which enhances the voice for news programs
Theater	Enables extra bass and treble to enhance the movie experience;

How to customize your own sound quality

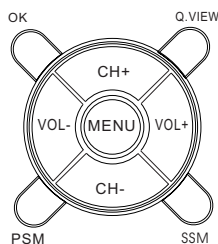

1 Press MENU button and VOL+/- button, till the **SOU.** menu shown on the right display on the screen.

Volume	50
Balance	0
SOU. Mode	Personal
Treble	50
Bass	70
Surround	On
AVC	Off
Woofers	Off

2 Press CH+/- buttons to select the item to be adjusted, then press VOL+/- buttons to obtain the desired effect.

Treble: Increases or decreases the treble.

Bass: Increases or decreases the bass.

Sound Control Functions

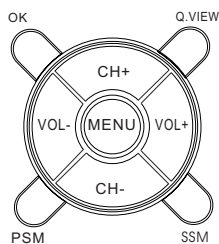

(Continue)

Balance

This will adjust the output of the right and left speakers to obtain the best stereo reproduction for your listening position.

The intermediate value is 0. When indication value of Balance increases toward +50, sound of the right and left speaker becomes stronger and weaker, respectively. When indication value of Balance decreases toward -50, sound of the right and left speaker becomes weaker and stronger.

Press CH+/- button to Select **Balance**,
Press VOL+ button to increase the audio output in the right speaker;
press VOL- button to increase the audio output in the left speaker.

surround sound

The surround sound feature expands the audio listening field wider and deeper to create exceptional sound quality from the TV's speakers.

Press CH+/- button to Select **Surround**,
press VOL+/- button to set Surround as **Off** or **On**

AVC(Auto volume control)

Each broadcasting station has its own signal conditions, and so it is not easy for you to adjust the volume every time the channel is changed. This feature lets you automatically adjust the volume of the desired channel and reduces the volume differences between channels and programs, providing a more constant overall level. This will also reduce the dynamics of sound.

Press CH+/- button to Select **AVC**,
press VOL+/- button to set Surround as **Off** or **On**

Woofersound

Woofers is a speaker that complements front speaker's reproduction capability of low-pitched sound.

Press CH+/- button to Select **Woofers**,
press VOL+/- button to set Surround as **Off** or **On**

Sound Control Functions

Mute



How to eliminate sound

When you need to pay attention to surrounded sounds, or there is a telephone calling you or there are some guests visiting you, the sound elimination (mute) function is very convenient.

1 Press the MUTE button on the remote control and "MUTE" type face will display on the lower part of the screen. At this time, the sound of the TV set is turned off.



2 If you want to recover the sound, press the MUTE button again or directly press the VOL-/+ buttons.

Time Functions

Clock setting and timer on/off functions

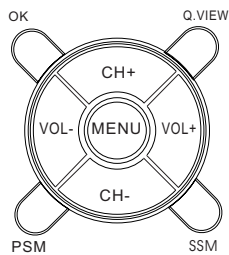

Clock setting

The clock will only work if the TV set is turned on or in standby. When the set is disconnected from the power supply or is turned off by the main power on the rear panel, the clock loses power and will need to be reset when the power is reconnected.

1 Press MENU button and VOL+/- button, and the **TIME** menu display on the Screen.

Clock	--:--
Off Time	--:--
On Time	--:--
On Prog	000
Remind Time	--:--
Remind Prog.	000

2 Press CH+/- buttons select "**Clock**", press VOL -/+ buttons to select hour or minute position, then press the digital buttons to set the value of hour or minute;

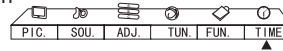

On/off timer

Using on/off timer function, the TV set can automatically turn on to a preset program or shut down in a preset time.

1 Press CH+/- buttons to select "On time", press VOL -/+ buttons to select hour or minute position; then press the digital buttons to set the value of hours or minutes.

Clock	--:--
Off Time	--:--
On Time	--:--
On Prog	000
Remind Time	--:--
Remind Prog.	000

2 Press CH+/- buttons to select "On prog", then press the digital buttons to select your desired channel.

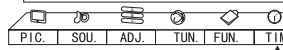

3 Repeat step 1-2 to set "Off time" .

Indication will appear on the screen 1 minute prior to expiry of set time.
Suppose Timer Off is set, and indication is as follows:

Off Time

When the above indication appears on the screen, set time may be changed if VOL +/- button is pressed.

NOTE:

1. If Clock option is setting, the time you set for Off Timer /On Timer will be a point of time. Otherwise, if Clock is not set, the time you set for Off Time/On Time will be a period of time.
2. Sleep Off/ Off Time can not be set at simultaneously. If both of the two are set, the later setup will be operation.

Time Functions

Remind Time and Remind Program setting

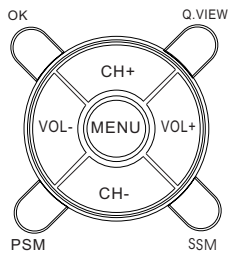

How to use the remind time and program

Program remind timer, that displays an on-screen reminder prompt, when a program on a different channel is due to start.

1 Press MENU and VOL+/- button to call up the **TIME** menu on the screen.

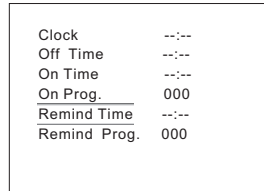

2 Press CH+/- buttons to select "**Remind Time**", then press VOL -/+ buttons to select hour or minute position; then press the digital to set the value of hour or minute.(take 19:30 as an example)

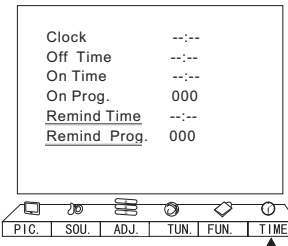

3 Press CH+/- buttons to move the cursor to "**Remind Prog.**", then press the digital buttons to set the desired channel.

Function menu

It is possible to select language, OSD transparency, menu timeout, calendar, 3A optimize, time skip.

Function menu operation

1. Press MENU and VOL+/- button to enter the FUN. Menu.
2. Press CH+/- to select desired item.
3. Press VOL+/- button to adjust the values level.
4. Press menu to exit.

Language	English
Menu Timeout	15seconds
Menu Background	Translucent
BlueScreen	Off
Calendar	
3A Optimize	Off
Time Skip	0Min

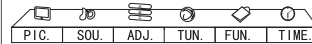

No adjustable in YPbPr/YCbCr/VGA/DVI/USB modes

No adjustable in AV/AV2/YPbPr/YCbCr/VGA/DVI/USB modes

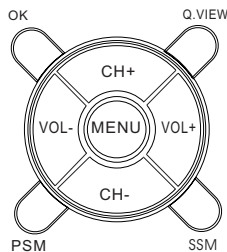

Menu Timeout

Repeat step 2 and 3 to set the menu out time.

Each Press of VOL+/- button repeatedly to select the number of preset minutes, the time will be set in sequence: 5seconds, 10seconds, 15seconds, 20seconds, 25seconds, 30seconds, 40seconds.

Menu Background

Repeat step 2 and 3 to select semi transparency and opaque background of OSD.

BlueScreen

Repeat step 2 and 3 to select BlueScreen.

If you select ON, when no signal, the background is blue; if you select OFF, when no signal, the background is dark.

3A Optimize

Repeat step 2 and 3 to set the **3A optimize** as on or off.

The 3A optimize tracks picture contrast and color to improve the quality of picture in terms of brightness and sharpness.

Calendar

Repeat step 2 to select the **Calendar**, press

VOL+ button to search the desired year or month.

Press CH+/CH- button to adjust the desired year or month.

1981-01-01						
Sun.	Mon.	Tue.	Wed.	Thu.	Fri.	Sat.
				1	2	3
4	5	6	7	8	9	10
11	12	13	14	15	16	17
18	19	20	21	22	23	24
25	26	27	28	29	30	31

Time Skip

Repeat step 2 to select

the **Time Skip**, Each Press of VOL+/- button repeatedly to elect the number of preset minutes, the time will be set in sequence: 0seconds, 1seconds, 2seconds, 3seconds, 4seconds, 5seconds, 6seconds, 7seconds, 8seconds, 9seconds, 10seconds.

Adjust menu

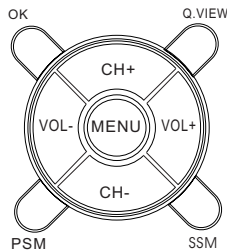

1. Press MENU and VOL+/- button to enter the ADJ. menu.
2. Press CH+/- to select desired item.
3. Press VOL+/- button to adjust the values level.
4. Press menu to exit.

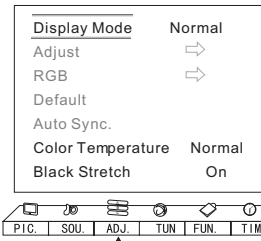

Display Mode

Repeat step 2 and 3 to set the Display Mode.

Normal

Choose **Normal** when you want to view the picture without any alteration. However, the top and bottom portions of the picture will be cropped.

Wide Screen

Choose **Wide Screen** when you want to adjust the picture horizontally, in a linear proportion to fill the entire screen.

4:3 Mode

Choose **4:3 Mode** when you want to view a picture with an original 4:3 aspect ratio, with black bars appearing at both the left and right sides.

You can also press PIC.SIZE button on remote controller to select the desired picture ratio.

Color temperature

Repeat step 2 and 3 to set the **Color temperature**.

There are four kinds of modes (i.e., "**Normal**", "**Warm**", "**Green**", "**Cold**") can be selected in turn.

This will increase or decrease **Warm** (red) and **Cool** (blue) colors to suit personal preferences. Select **Cool** to give the white colors a blue tint, **Normal** to give the white colors a neutral tint, **Warm** to give the white colors a red tint. **Green** to give the white colors a green tint.

Black Stretch

Black Stretch-(Automatically Increases the Contrast Rage)

Repeat step 2 and 3 to set the **Black Stretch**.

Adjust menu

In VGA and DVI input mode, H-Position and V-Position can be adjusted to eliminate transverse line interference and decentered picture.

PC setting

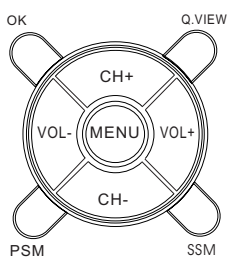
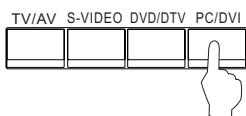

Note:

1. As adjusting H position or V position parameter, It is natural that the picture will have faintness once in a while if the range is more, then to adjust contrarily to normal position.
2. H-position, V-position, Auto Adjust are not available in TV mode.
3. Auto Adjust is not available in AV and S-VIDEO mode.

PC setting

Press PV/DVI button to select PC or DVI mode.

- 1 Press MENU button and VOL+/VOL- button, till the ADJ. Menu display on the screen.
- 2 Press CH+/- buttons to select the item to be adjusted, then press VOL+/- buttons to adjust.

Only be adjustable in the VGA/DVI mode.

Display Mode	Normal
Adjust	⇒
RGB	⇒
Default	
Auto Sync.	
Color Temperature	Normal
Black Stretch	On

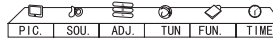

Adjust

This will adjust the picture of H-position, V-position, H-size, V-size and Fine Tune.

Press CH+/- buttons to select **Adjust**, then press VOL+/- buttons to enter the sub menu.

H Size	0
H Position	0
V Size	0
V Position	0
Fine Tune	0

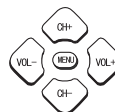
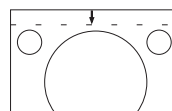
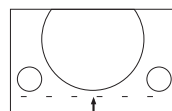
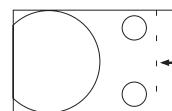
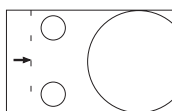
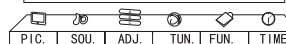

H Size: Horizontal size of picture can be adjusted in this item.
H Position: Horizontal position of picture can be adjusted in this item.

V Size: Vertical size of picture can be adjusted in this item.
V Position: Vertical position of picture can be adjusted in this item.

Fine Tune: Adjust phase to the best effect suiting for VGA signal.

Adjust menu

In VGA and DVI input mode, H-Position and V-Position can be adjusted to eliminate transverse line interference.

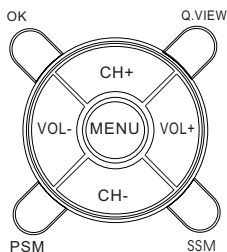

NOTE :
As the frequency of display differ in PC device, you may select the appropriate frequency to obtain desired effect. If the signal of receive is excess, the picture can be not displayed or wrong on the screen.

(Continue)

PC setting

1 Press CH+/- buttons to select **RGB**, then press VOL-/+ buttons to enter the sub menu.

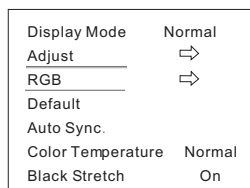

2 Press CH+/- buttons to select the desired item, press VOL+/- button to adjust.

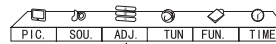

RGB is opted for adjustment of the numerical value of red, green and blue in VGA/DVI mode.

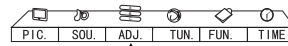
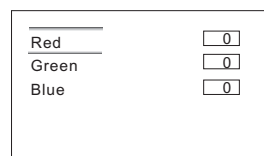

Default

This is opted for adjustment of parameters to delivery setup in VGA mode.(After the operation, complete will be on the right of the operation)

Repeat step 1 and 2 to set the **Default**.

Auto Sync

This is opted for adjustment of picture location frequency and phase parameters in VGAmode.(After the operation, complete will be on the right of the operation)

In VGA ,if no signal input, the Auto Sync will be no adjustable.

Repeat step 1 and 2 to set the **Auto Sync**.

Note

Recommendatory frequency as follow:

Sequence	frequency	H-frequency (KHz)	V-frequency (Hz)	Remark
1	640*480@60Hz	31.5	60	DOS
2	800*600@60Hz	37.88	60	VESA
3	1024*768@60Hz	48.36	60	VESA

Lock setup

The television has the function of security default lock. Password needs to be entered when the program lock mode is to be set.

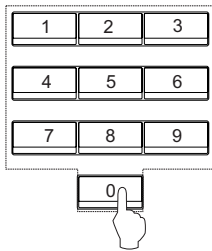
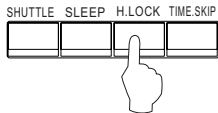

Note:

If Clear Lock is activated, the password setup cannot be changed.

How to use the password function

Press H.LOCK button, Password will appear on the screen.



The initial password of the television is 0000 and security default password is 9443. then enter Lock Set menu. (as follow)

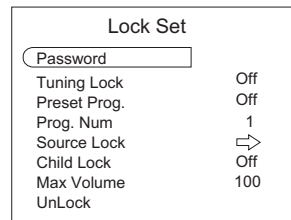

Note: If the password is not correctly entered, you will be required to reenter the password and the cursor will stay at the first place.

Press EXIT to cancel the window.

To set new Password

The password can be changed.

After entering the Lock set menu, Press CH+/- to select **password**, Press vol+/-, the screen will display the follow.



If correct password is entered, the screen will display the follow.



Press digital button to set the new desired password, and the screen will display the follow.



If the desired password is entered correctly twice, the old password will be changed. If the desired password is not correctly entered twice, the screen will display New ----, then you have to reenter the password.

Lock setup

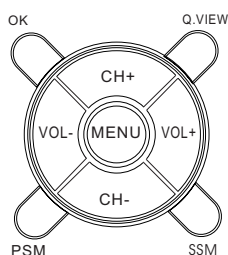
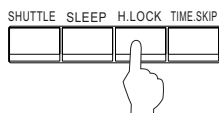

Tuning Lock

Press **CH+/-** to select Tuner Lock and **VOL+/-** to set On/Off. (To set On, some operation such as search will be not available. When enter the TUN. menu, Tuner Lock will be on the screen, and the time will be the same with the main menu if no operation. If you want to operate TUN. menu, you need to enter the Lock menu to set Tuner Lock Off or operate Clear Lock.

Preset Prog.

Prog Set is opted for setting up start channel. Press **CH+/-** button to select Prog Set. Press **VOL+/-** button, sources can be swapped in TV/AV1/SAV1/AV2/YPbPr/VGA/DVI/USB/Off mode. After setup, this set mode will be entered if the television is switched off and on again. To set Off, the television will memory the off-channel.

Prog. Num

Prog Num is opted for setting up preset channel. Press **CH+/-** button to select Prog Num. Press **VOL+/-** button, to select channel number. (The item is not available except TV signal.)

Source Lock

Source Lock is opted to hinder external input modes, such as AV, Scart and VGA. Press **CH+/-** button to select the option, and press **VOL+/-** button to display Source Lock menu as follows:

Source Lock	
AV1	Off
SAV1	Off
AV2	Off
YPbPr/YCbCr	Off
VGA	Off
DVI	Off
USB	Off

Press **CH+/-** button to select desired option. Press **VOL+/-** button to set up the mode of Source Lock. If some Source Lock is set **ON**, the mode will be entered and the screen will display blue background with the mute mode activated and Lock. In lock on mode, when screen is blank, icon Lock will be always displayed on the screen. If lock mode is to be verified, enter Source Lock submenu and set relative mode off, or select Clear Lock in the Lock Set Menu.

Lock setup

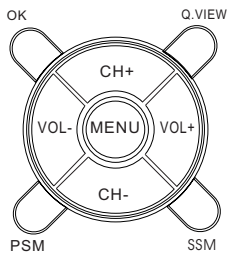

Child Lock

Press **CH+/-** button to select Child Lock. Press **VOL+/-** button to set **On** or **Off** mode. If lock on mode is set, Child Lock is activated automatically. In such case, if Child Lock button (button on the television) is pressed, the screen will display **Child Lock**, which can be erased by press of **EXIT** button. 5 seconds later after the latest press, the screen display will disappear automatically. The Child Lock mode can be resumed by entering Lock Set menu, set Child Lock **ON** or **OFF**.

Max Volume

Press **CH+/-** button to select Max Volume. Press **VOL+/-** button for adjustment between 0~100. If a certain value is set, when volume is being adjusted, the sound value can not exceed maximum volume value. If current volume is over Max Volume, when Lock Set menu is set, current volume will become set maximum volume. If current volume is below maximum volume, customer set volume will stay unchanged.

UnLock

Press **CH+/-** button to select Unlock mode. Press **VOL+/-** button to unlock all set modes, setting all lock options to off, and the maximum volume returns to 100.

Others functions

Nicam、Sleep、display functions

I/II

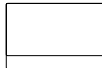

NICAM

Press the I/II button will result in fast swap of **NICAM** function of current program.

DISPLAY

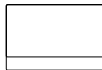

Display function

Press the DISPLAY button, then the channel number and system will be displayed on the screen. Press the DISPLAY button again, it is disappear.



SLEEP

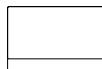

Sleep

The TV set will switch automatically to standby at the preset time with the SLEEP time on. You may set the sleep time.

each press of **SLEEP** button repeatedly on the remote control to select the number of preset minutes, the timer will be set in sequence: **(0Min, 5Min, 15Min, 30Min, 60Min, 90Min, 120Min)**.

After the sleeptime is programmed, the display will appear briefly every ten minutes to remind you that the sleep timer is operating.

To confirm the sleep timer setting, press **SLEEP** and the remaining time will be displayed for a few seconds.

To cancel the sleep timer, press **SLEEP** repeatedly until the display turns to **0 Min**.

Others functions

Scan、 Shuttle functions

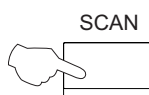

Scan

1 If you want to select a desirable program, you may scan all the TV programs in memory. You can simply press **Scan** button to do this. Press scan button once, there are nice pictures on the screen, press Scan button again, there are sixteen pictures on the screen to scan.

2 If you want to stop the function during auto tuning, simply press **Scan** button again.

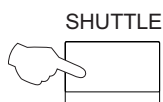

Shuttle function

Shuttle function enables quick swap to setting program.

Press Shuttle button about 3 second, and the display **store** on the screen, at the time, you may operate other, then if you scan over program, you may press again shuttle button to return to the setting program.



Stream media broadcast system

Stream media play prepare

1. Supporting equipment

1. Equipment supporting Mass and Storage agreements include USB, mobile hard disk, card reader, some MP3 and digital camera.

2. Equipment supporting PTP agreement includes some digital camera.

2.1 Supporting media:

picture, music, MPEG4, MPEG2 and MPEG1;

Supporting file format:

*.Avi, *.DIVX, *.MPEG, *.DAT, *.MP3, *.WMA, *.JPG and *.JPEG. Due to particularity of file code and file mode, It is possible that some files cannot be read.

2 If Pic & Music mode is activated, relative media file format will include JPEG and MP3 files. After Picture is selected, MP3 files set for play will open both music and picture files for sync play performance. As some files must be read while music is being played, the speed of picture operation response might be affected.

3. Before starting operation, verify USB storage device is of FAT32 and FAT file system format. At present, this television does not support NTFS and the file system of other format.

4. Many movie files use suffix of AVI and MPG. However, many kinds of format

are used for internal files. This television can only play some AVI and MPG files of this format. Those files with suffix of dat are not movie files, but data files used by computers, and cannot be played for movies.

5. External card reader supports most digital cards available in the market. Readable digital cards are classified according to the property of card readers and can be connected to mobile hard disks (working voltage 5.0V, working current not over 500mA).

6. Sometime the television operation may be halted due to excessive rate of information code errors. In such case, restart the system. As there are many nonstandard USB mobile devices in the market. If this kind of USB mobile devices are used in the stream media play system, the problem of identification failure might occur. The same problem may also happen with computers, not televisions.

7. It is suggested that the external devices with USB2.0 interface be used to improve velocity of information reading and continuity of information play.

Stream media broadcast system

Stream media system setup

Note: Memory cards or USB devices are not supplied with this TV.

USB setup

- 1 Insert USB in the card slots at the left side the TV.
- 2 Insert it to be clicked in.
- 3 Press USB button on the remote controller to enter the stream media system.

CARD setup

This TV is compatible with the card of SD/MMC/CF/MS/SM format.

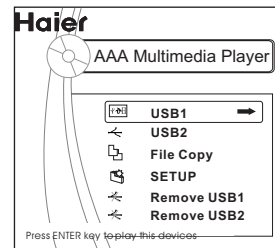

How to use

1、 Jack of card Instructions:

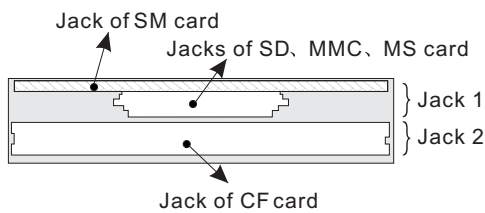

Note

1. Please note chooses uses the digital memory card with you corresponds the receptacle
2. Card reader in 1 cannot simultaneously insert two kind of cards in the graphical representation position

2、 Insert the card as right direction. As following Card in common use

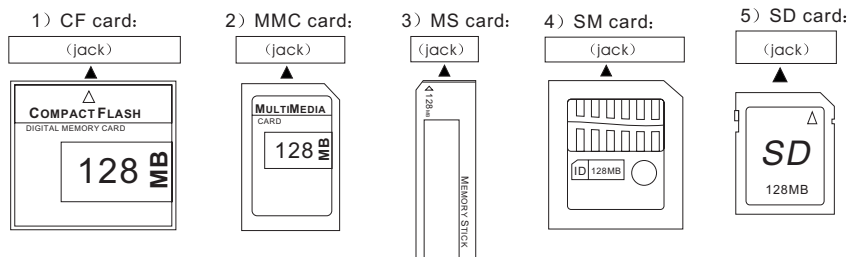

Note:

1. the card insertion time, after the flows media system starts 2s, insert the card to numerical code card reader, do not bring card to start flow media system.
2. After card insertion, indicator light will shine, and enters glitters condition, after period of time, indicator light enters constant bright condition, indicates already distinguishes finished, this time carries on play operation and so on.
3. In the market, the digital card type are very many, please uses standard product of the standard factory, meets reads takes difficult or reads speed limits, please replaces the digital card.

Stream media broadcast system

Removing USB device

- 1 Press up ↑ or down ↓ to select Remove USB, and press ENTER button to ensure it.
- 2 press **RETURN** button to exit menu.
- 3 Remove the memory card/USB device.
- 4 If to remove the card device, press **RETURN** button to return to the main menu, and remove the card.

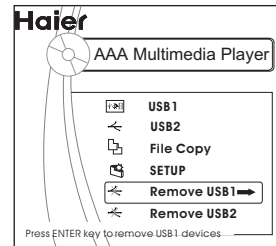

Card data protection

- Do not remove the card/USB device when the content is being read or when browsing. Such action may damage the memory card/USB device.
- Do not touch the terminals on the back of the card.
- Always insert a card in the correct direction. Failure to do so may result in damage to the card and the unit.
- Do not subject the card to excessive pressure or strong impacts.
- Malfunctions of the unit or card may result in data loss or damage to the card.
- Haier shall not accept any liability for damage or loss of stored data.



Warning:

Memory cards can be swallowed by young children. Do not allow children to handle memory cards. Please remove the memory card immediately after use.

Stream media broadcast system

To start the media play

1. Press **USB** button to enter media play system.
2. Press up ↑ or down ↓ button to select the desired option.
3. Press **ENTER** button to enter desired option.
4. Press **RETURN** to return the previous menu.

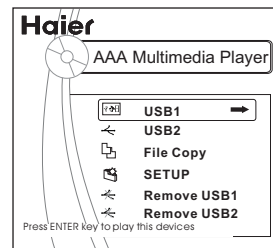

5. If to exit USB system, you need to return to the main menu to protection card data.

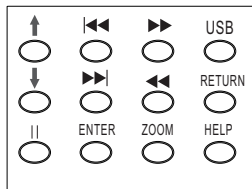

Note: If there are no operation two minute later, the TV will enter the saver automatically, at the time, press any button of USB system to exit the saver menu.

To operate the menu

1. Press up ↑ or down ↓ to select the item with up or down.
2. Press ◀ or ▶ to select the desired item of submenu with left or right.
3. Press **ENTER** button to ensure the desired option, to enter the submenu, to resume the speed of standard.
4. Press ▶ or ◀ button to operate play quickly or slowly.
5. Press pause II button to make the program stop, and press again to resume it.
6. Press **ZOOM** button to make zoom, and press ◀ or ▶ or ↑ / ↓ button to enjoy the detail.
7. Press **HELP** button to call up or exit the OSD information. And press **HELP** button to call up or exit the OSD during operating file copy.
8. Press **RETURN** button to return to previous menu and stop play, press **RETURN** button repeatedly to return to main menu.

Stream media broadcast system

To select stream media broadcast system

1. Press up ↑ or down ↓ button to select "Card" or "USB".
(The device be inserted and identified).
2. Press **ENTER** button to enter adjusted option.

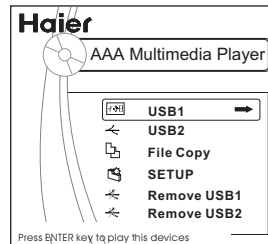

To play picture

1. Press up ↑ or down ↓ button to select Picture item.
2. Press **ENTER** button to enter the menu of play.
3. Press again up ↑ or down ↓ button to select desired enjoy picture, and then press **ENTER** button to enter the play menu.
4. On screen display, Press ↑ or ↓ to select the speed of play. (Normal, Slow, Fast).
5. Press ◀◀ or ▶▶ button to swap the picture of next and previous. Press **RETURN** button to return.

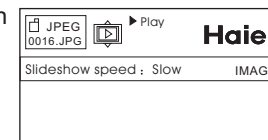
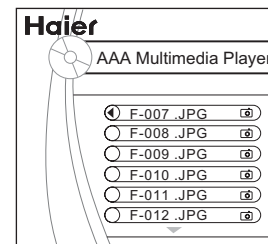
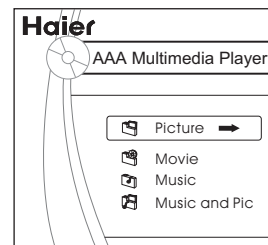

To enjoy the picture detail

1. After selecting the picture to play, press **ZOOM** to select desired zoom.
2. Press **HELP** button to exit the display, and then press ↑ or ↓ or ◀◀ or ▶▶ to move and enjoy the picture detail.

To make the picture overturn

Each press of ▶▶ button to make overturn 90° with right, press **ENTER** button to resume the program playing.

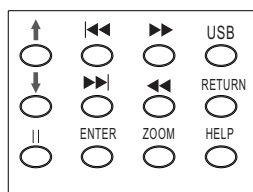

Note:
the play file menu are different with your USB devices.

Stream media broadcast system

To enjoy music

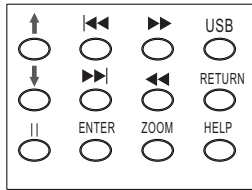

1. Press up ↑ or down ↓ button to select "Music" option.

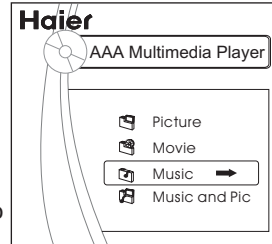

2. Press ENTER button to enter play menu.

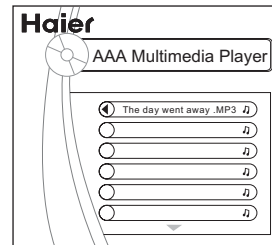

3. Press up ↑ or down ↓ button to select desired music, and then press ENTER button to play music.

Note: The play file menu are different with your USB device.

4. When playing music, press up ↑ or down ↓ to select play mode, (play mode: standard, program, Random; Repeat mode: Disc Repeat, Folder Repeat, File Repeat) and press ENTER button to ensure the mode.



5. When playing music, press ◀◀ or ▶▶ button to swap the next and previous music

6. Press RETURN button to exit the playing.

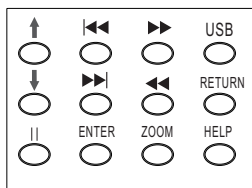

Note: 1. **DISC Repeat mode:** press up ↑ or down ↓ button, the DISC Repeat will appear on the screen, and then press ENTER to ensure it.

2. **Program mode:** press ↑ or ↓ button to select the music in right list, and press ENTER button to program in turn, and then press ▶▶ button to select "Done", and then press ENTER button to ensure it.

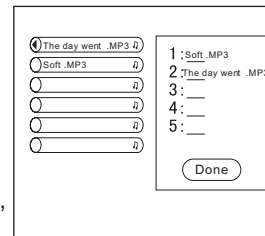

Stream media broadcast system

To play Movie

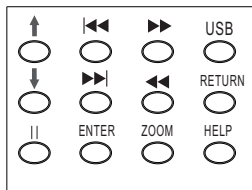

1. Press up ↑ or down ↓ button to select "Movie" option.

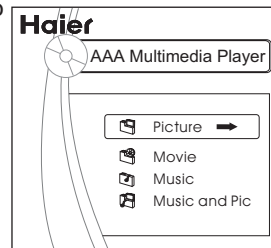

2. Press **ENTER** to enter play menu.

3. Press again up ↑ or down ↓ button to select desired movie, and press again **ENTER** button to play it.

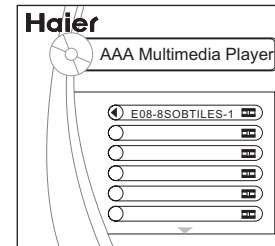

4. On screen display, press **◀◀** or **▶▶** button to select in turn:

File*-PlayBack Control-Audio channel-Play Mode

5. Press **▶▶** or **◀◀** button to set speed, press **ENTER** button to resume to standard mode.



6. Press **◀◀** or **▶▶** button to select the next movie or previous.

7. Press **RETURN** button repeatedly to return.

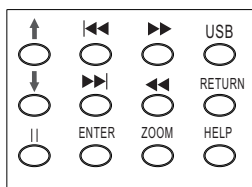

Stream media broadcast system

To select the Music and PIC item

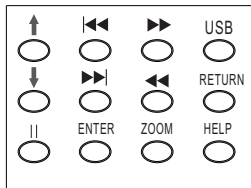

1. Press up ↑ or down ↓ button to select "Music and Pic" option, and press **ENTER** button to enter menu.

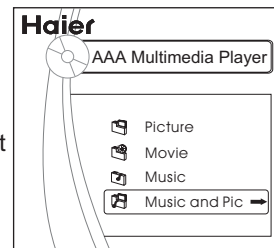

2. Press up ↑ or down ↓ to select desired file, and press ►► button to ensure it. (◀◀ to cancel). Repeat step 2 to select more file, and press **ENTER** button to enter play menu.

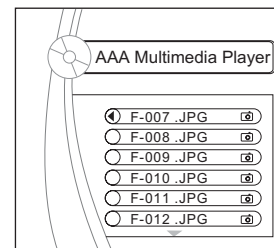

3. On screen display menu, press up ↑ or down ↓ to select the speed to play. (**Normal, Slow, Fast**).

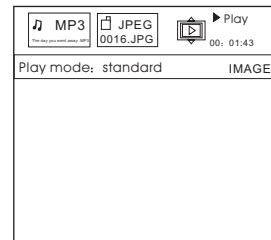

4. Press ►► or ◀◀ button to swap the next and previous picture, press ◀◀ or ►► button to select the music.

Note: press pause || button to stop playing the picture.

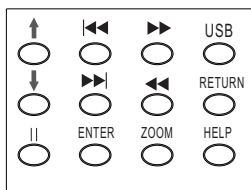

5. Press repeatedly **RETURN** button to return.

Note: On the music and picture, the playing music is *.mp3 format.

Stream media broadcast system

Copy file function

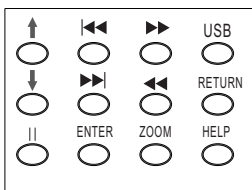

1. Press up ↑ or down ↓ to select "File Copy" item.

2. Press **ENTER** button to enter the copy menu.

3. Press **ENTER** button to enter the file menu, and press up ↑ or down ↓ button to select "Card" or "USB".

4. Press **ENTER** button to enter Card or USB, and select the files to copy, then press **HELP** button to call up COPY and PASTE, and then press ↑ / ↓ button to select COPY, and press **ENTER** button to confirm, press again ↑ / ↓ button to select PASTE, then press **ENTER** button to paste, in this time, the "File already exists, overwrite it?" will appears on the screen, and press **LEFT** or **RIGHT** button to select YES/NO, and then press **ENTER** button to confirm.

5. Press **ENTER** to cancel.

Note:

▶▶ button to select the all files;
◀◀ button to cancel.

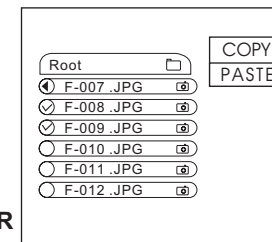
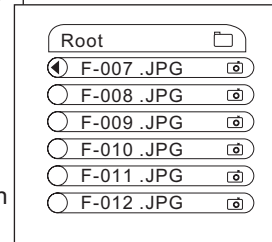
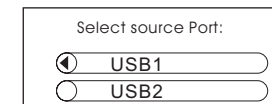
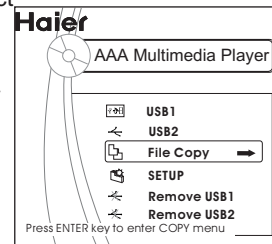

Stream media broadcast system

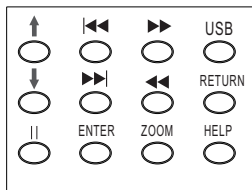

To select language

1. Press ↑ or ↓ to select "SETUP " item.
2. Press ENTER button to enter the SETUP menu,
3. and press again ENTER button to enter language option.
4. Press ↑ or ↓ to select desired language, and press ENTER to ensure it.
5. Press RETURN button to return.

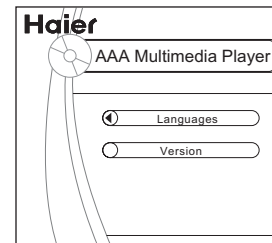
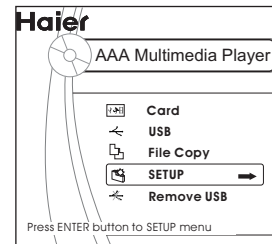

To display the version

1. Repeat steps 1-2, and then press ↑ or ↓ to select version.
2. Press ENTER button to display the version number.

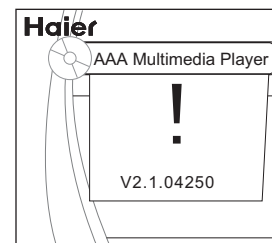

Specifications and functions

Picture proportions 4:3/wide screen: (3 modes)
Panorama picture: 16:9
Picture element: 1366×768
Multi-input compatibility
Advanced technology for motion picture processing
Two speakers/optional

Complex component: RCA-pin×3
Component video signal: YUV×1
S terminal: Mini DIN 4-pin×1
RGB input: D-sub 15-pin×1 (480i/p, 720p, 1080i, 1080p)
Audio input: RCA-pin TYPE (L/R)×4: full support
separate audio frequency input
Audio system: stereo

Size: (WxDxH) unit: 1010mmX300mmX605mm
(stand and speaker included)

Working conditions

Power: ~150V-240V, 50/60Hz
Power consumption: ≤140W

Temperature

Working: 5°C~35°C Storage: -10°C~45°C

Humidity

Working: 20~80% Storage: 5~90%

Maintenance

- Early malfunctions can be prevented. Careful and regular cleaning can extend the amount of time you will have your new TV. Be sure to turn the power off and unplug the power cord before you begin any cleaning.

Cleaning the Screen

1. Here's a great way to keep the dust off your screen for a while. Wet a soft cloth in a mixture of lukewarm water and a little fabric softener or dish washing detergent. Wring the cloth until it's almost dry, and then use it to wipe the screen.
2. Make sure the excess water is off the screen, and then let it air-dry before you turn on your TV.

Cleaning the Cabinet

To remove dirt or dust, wipe the cabinet with a soft, dry, lint-free cloth. Please be sure not to use a wet cloth.

Extended Absence

If you expect to leave your TV dormant for a long time (such as a vacation), it's a good idea to unplug the power cord to protect against possible damage from lightning or power surges.

Troubleshooting

For the sake of time and cost, it is strongly recommended that you check out the problem by yourself according to the instructions listed hereunder before contacting the after-sales service for technical assistance.

Problem	Possible remedies
No picture, no sound	Turn on the power supply; Properly plug the TV set to the power socket; Check to see if the power cable of other appliance is plugged in the TV set. Make sure that the power cable of the TV set is properly connected.
Good picture, no sound	Depress the volume button; Check out the audio frequency input signals.
Failure of remote controller	Check to see if the remote controller display receiving window are blocked by other objects and if batteries are properly loaded.
No color, weak color or poor picture	Designate the item of color from the Picture menu and depress the volume button; Keep the display and VCR separate a reasonable space; Activate some functions to store picture brightness; Make sure that the display and signal source are available and turned on.
Excessive brightness or darkness	Adjust brightness or contrast.
Picture too big or small	Adjust the setup of sizes.
One speaker failure	Balance the sound in the menu.
Slight sound from display	It is a normal phenomenon.

Note: Do not leave the television with static picture in an extended period as it may result in residual image on your television screen.

Note: Production of the screen requires high and precision technologies. However, there might be some dark or bright (red, blue or green) spots, or some anomalistic stripes or spots. This is not defect. If the TV set is used in an area 2,400 meters above the sea level where the air pressure is below 750hpa, the picture on the screen may be affected and a muffled sound might be produced. These phenomena might happen in the area 1,500 meters above the sea level. This is resulted from difference between air pressures inside and outside the display. This is not a defect covered by the limited warranty.

NOTE

Design and specifications are subject to change without notice.
The dimension in this manual is a approximation.

Haier

01
0090506321A

Free Manuals Download Website

<http://myh66.com>

<http://usermanuals.us>

<http://www.somanuals.com>

<http://www.4manuals.cc>

<http://www.manual-lib.com>

<http://www.404manual.com>

<http://www.luxmanual.com>

<http://aubethermostatmanual.com>

Golf course search by state

<http://golfingnear.com>

Email search by domain

<http://emailbydomain.com>

Auto manuals search

<http://auto.somanuals.com>

TV manuals search

<http://tv.somanuals.com>