

Haier

COLOR TV RECEIVER

OWNER'S MANUAL

Please READ this manual carefully before operating the unit, and keep it for future reference.

The Owner's Manual for the Follow Models:
21F9D-P, 21T9D-P, 21F9D, 21T9D, 1407

*Please read this manual carefully before using your television and keep this manual in a good place for future reference.

CONTENTS

Before Operation

Warning and cautions	2
Installation	3
Aerial connection.....	3
Preparation of the remote control unit.....	3
Function buttons and external sockets	4
Front panel of the TV set.....	4
Rear panel of the TV set.....	4
Buttons on the remote control	5
Basic operation	
Switching on/off the TV set	6
Watching TV program	7
Watching TV program.....	7
Program swap and auto scan functions.....	8
Searching channel	9
Full automatic search mode.....	9
Semi-automatic search.....	10
Manual fine tune.....	11
Program skip	12
Convenient picture and sound control functions	13
Multiple picture modes	13
Black stretch and noise reduce.....	14
Mute function.....	15
Time functions	16
Clock setting and timer on/off functions.....	16
Sleep timer and program preset	17
Setup function	18
Screen saver and child lock functions.....	18
AVL and calendar functions.....	19
Select language.....	20
Position exchange function	21
Others	
Connection to the external audio and video equipment	22
Troubleshooting guide	23
Specifications	24

Warning and cautions

1. When you clean the TV set, please pull out the power plug from AC outlet. Don't clean the cabinet and the screen with benzene, petrol and other chemicals.



4. Do not place the TV set near rain or moisture as it may cause an electric shock, or the TV set to catch fire. The TV set must only be used in dry in door locations.

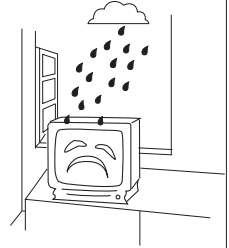

2. In order to prolong the using life of the TV set, please place it in a well ventilated location.

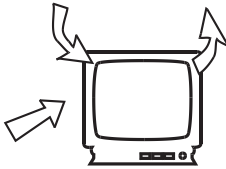

5. The back cover must only be removed by a registered electrical service person. Removing the back cover may result in electric shock, fire or damage to the TV set.



3. Don't place the TV set in direct sunlight or near a heat source.

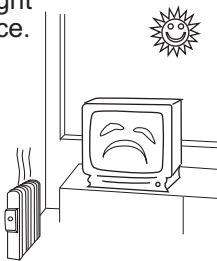

6. If the TV set is not going to be used for a long time, or there is a severe thunder & Lighting storm, it is recommended that the TV set be disconnected from the AC power outlet and the aerial plug removed.

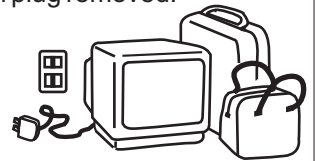

Explanation on the display tube

In general, it is not needed to clean the tube surface. However, necessary, it's surface can be cleaned with a dry cotton cloth after cutting off the power. Don't use any cleanser. If using hard cloth, the tube surface will be damaged.

Installation

Aerial connection

Generally speaking, to enjoy a clearer picture, we recommend that you use a CATV system or an outdoor antenna. In different places, the suitable antenna type and position are different.

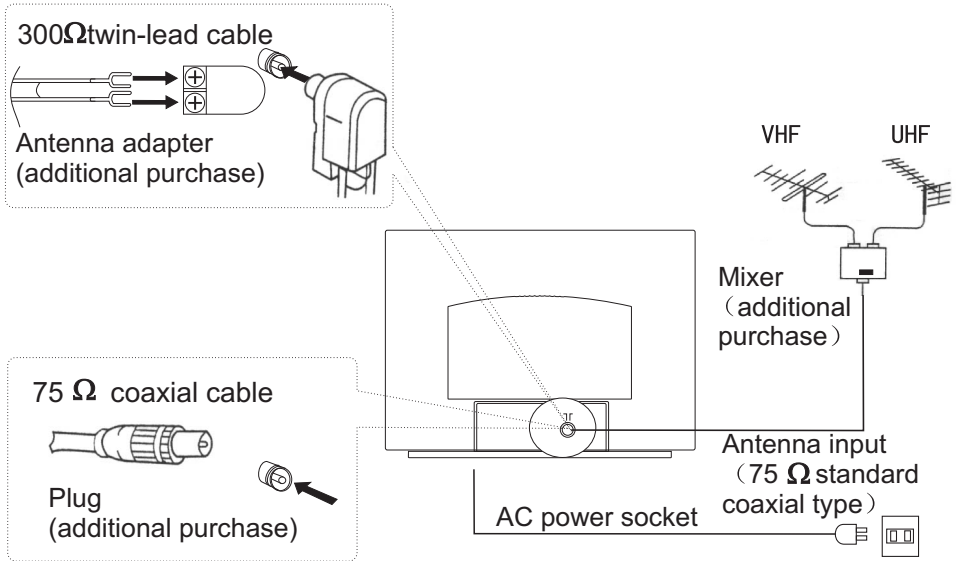

Note:

- * It is recommended that you'd better use 75Ω coaxial cable to remove the disturbance caused by airwave.
- * Don't bind antenna cable and power wire together.

Preparation of the remote control unit

Battery installation

Take off the battery compartment cover. Place two AAA batteries, make sure that battery polarity matches with the +/- mark inside the battery compartment.

Operation notes for the remote control unit

- Under normal conditions, the life time of batteries is one year.
- If you don't intend to use the unit for a long period or the electricity of the batteries is used up, remove the batteries to prevent batteries acid from leaking into the battery compartment.
- Don't throw your batteries into a fire. Dispose of your batteries with a specified method.
- Avoid the falling and the wetting of the remote control unit.

Function buttons and external sockets

Front and side panel of the TV set

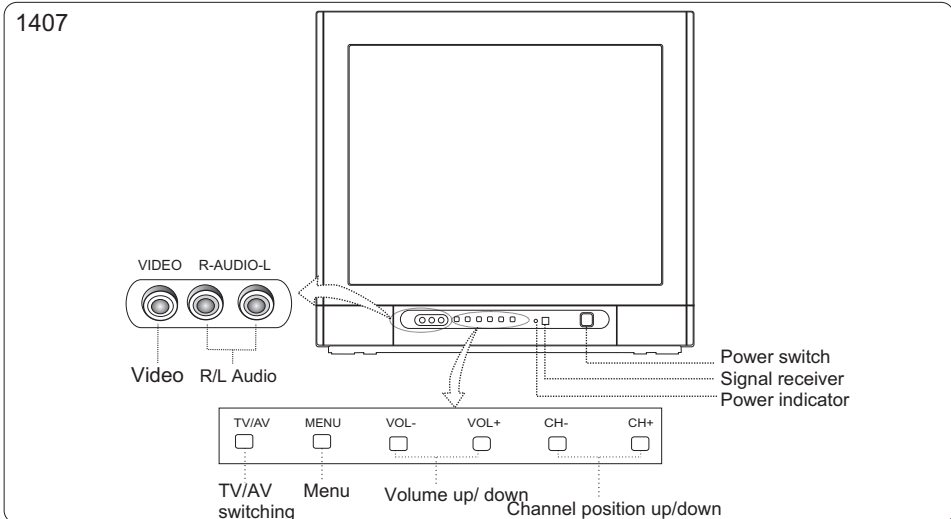

21F9D, 21F9D-P, 21T9D, 21T9D-P

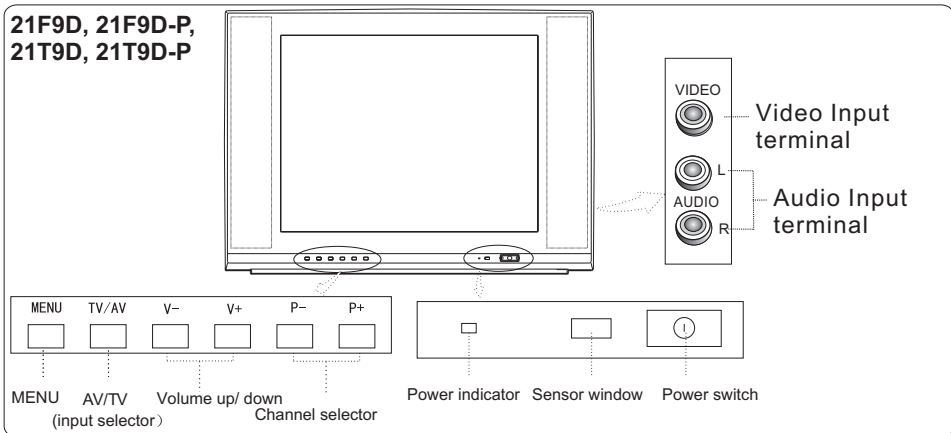

Note: The cabinet and buttons of TV is only for reference.

Rear panel of the TV set

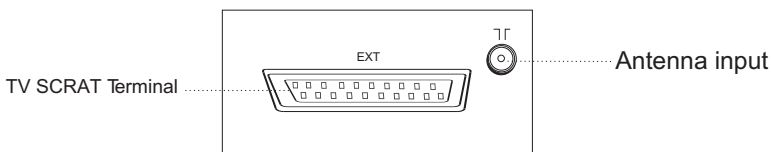

NOTE

If you want to connect the TV set to the other audio/video equipment, please refer to P22.

Buttons on the remote control

Buttons and Descriptions

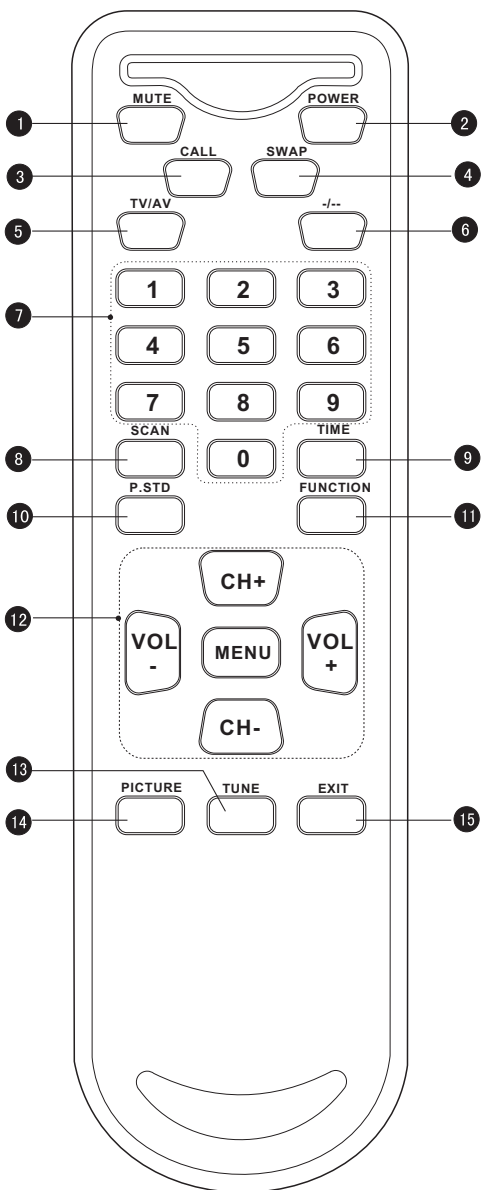

- 1 Mute Button
Press to conceal the sound of programs.
- 2 Stand by Button
- 3 Screen Display Button
- 4 Swap function Button
- 5 TV and AV Exchange Button
To exchanger between TV and other available video inputs
- 6 Digital selector
- 7 Program number Button
- 8 Program scan Button
- 9 Time menu
- 10 Picture mode selection
- 11 Function menu
- 12 Menu Select/Adjust Button
Use this button to adjust the menu, the volume and the channels.
- 13 Tune menu
- 14 Picture menu
- 15 Exit screen display

Switching on/ off the TV set

- In the following, the methods of using power switch and remote controller to switch on/off power supply for the TV set will be explained.

Switching on/ off the TV set

Switching on/ off the TV set

1 Please press the power switch to switch on AC power supply and the power indicator will light.

2 If the indicator is lighting in red, press the POWER button on the remote control again.

Note:

1 When you don't operate the TV set with a remote control, you can turn on it directly through pressing the P+/- buttons on the TV set (Child Lock must be turned off).

4
AUTO
BG



2 If you want to exchange to standby status, please press down the POWER button on the remote control.

3 If you want to fully switch off the power supply for the TV set, please press the power switch button on the TV set.

Auto switch-off function

When the "Back" function is on, if an empty channel is selected or the TV programs are ended for the day, the power will be switched off 5 minutes later automatically. If the "OFF TIME" is on, it will be switched off according to the presetting time. The auto power off function does not work under video input or when the background is off.

(Note: If the "off timer" is less than 5 minutes, it will be switched off automatically to the preset Time.)

Watching TV

- You can watch TV program in a preset channel.

Watching TV program

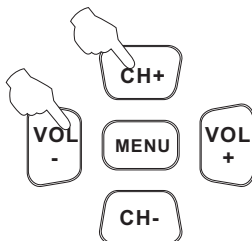
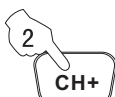
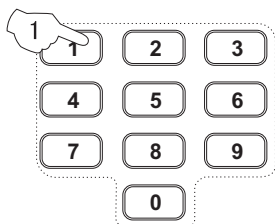

How to select TV program

Select the desired program

1 Using "Program number" buttons

- Directly enter the channel number with the numeric keypad on the remote control.
- To select channel numbers from 10 ~ 99 press [-/--] button and enter the two digit channel number
- To select channel numbers from 100 ~ 218 press [-/--] button twice and enter the 3 digit channel number

2 Using the CH+/- buttons

- Press the CH+ button to select a channel number in number increasing direction.
- Press the CH- button to select a channel number in number decreasing direction.

Select the desired sound

Press the VOL+/- buttons on the remote or the front of the TV set to adjust the volume level.

If the colour or sound of a channel is abnormal

The settings of the colour system or the sound system may be wrong.

Press the TUNE button and setting menu shown on the right will display on the screen.

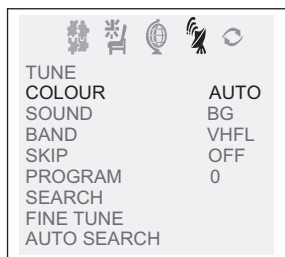

- If picture colour is abnormal
Use the CH+/- buttons to select Colour then the VOL+/- buttons to select the colour system.. Press the EXIT button to save the setting.
- If the picture sound is abnormal
Use the CH+/- buttons to select Sound then press the VOL+/- buttons to select the sound system.

Watching TV (continued)

- Swap function enables quick swap to the last watched program.
- Auto scan function enables automatic successive scanning of all the programs in memory with "OFF" skip status (each channel will last about 2 seconds).

Program swap and auto scan functions

Program swap



1 Suppose the channel number you used just now is 8 and the channel number you are using is 18 (as shown in the figure).

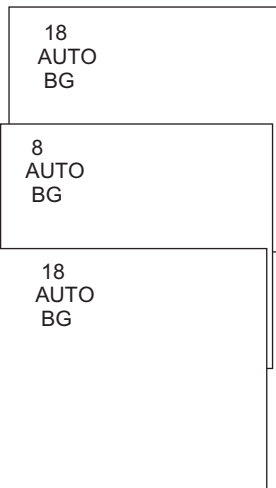

2 If you want to return to the last watched program channel 8, you can simply press the SWAP button.

3 If you want to return to channel 18, press the button again. Through this function, you can easily change between the channel you are using and the channel you used last time.

Auto program scan



1 If you want to select a desirable program, you may scan all the TV programs in memory. You can simply press the SCAN button to do this. The programs will appear one after another from beginning to end (each channel number will last about 2 seconds).

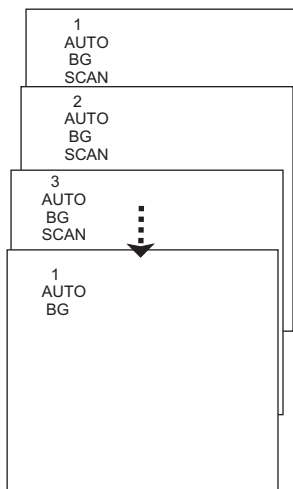

2 If you want to stop the function during auto scanning, simply press the SCAN button again.

Searching channel

- This TV set has three methods to set the channels, which are respectively full automatic, semi-automatic and manual fine tune.
- In this section, how to use the remote control to set the channel is explained. You can also use the buttons on the TV set to set channel.

Full automatic mode

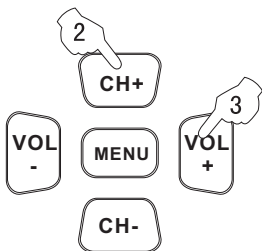

Automatic search

1 Press the TUNE menu button , till the TUNING menu shown on the right display on the screen.

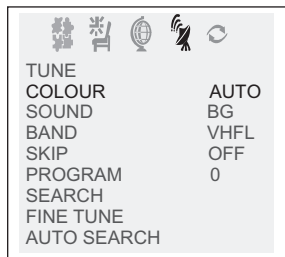

2 Press the CH+/- buttons to select "AUTO SEARCH".

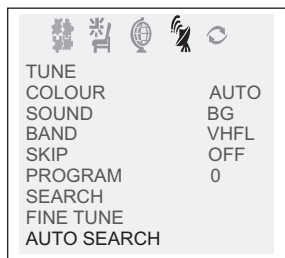

3 Press the VOL+ button to ensure automatic search function operates. All channels now playing program will be automatically preset in order . After the search has finished, the first program number will display on the screen.

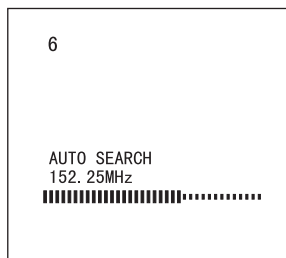

Display function

Press the CALL button, then the channel number and the systems will be displayed on the screen.



Searching channel

(Continued)

Semi-automatic search

Semi-automatic search

1 Press the CH+/- buttons or PROGRAM NUMBER (0-9) buttons to choose desired channels (I.E. channel 1) .

1
AUTO
BG

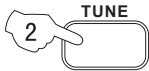

2 Press the TUNE menu button, till the TUNING menu shown on the right display on the screen.

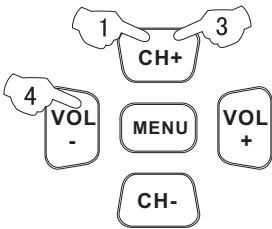

3 Press the CH+/- buttons to select "SEARCH".

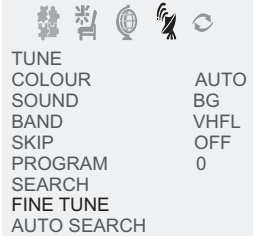

4 Press the VOL-/+ buttons to start searching.

The VOL- (down) button is used for lower side program search.
The VOL+ (up) button is used for higher side program search.

Repeat this step, till find the desired channel.

1

SEARCH
152.25MHz



To turn off the on-screen menu

In general, after you press the MENU button, the menu item display (PICTURE, TIME, FUNCTION, TUNE, EXCHANGE, ETC.) will automatically disappear within 15 seconds. If you want to eliminate these contents immediately, please press the EXIT button.

Searching channel

(Continued)

Program skip

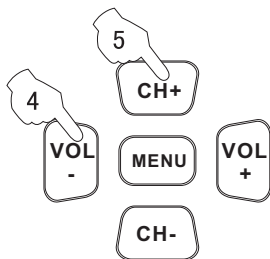
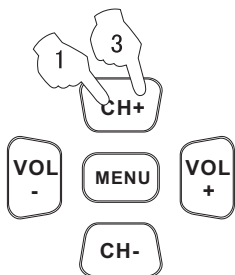

Program skip

The Program skip feature enables you to skip/hide programs that you do not wish to be displayed when using the CH+/- buttons. These channels will still be displayed by directly using the channel number buttons on the remote control.

1 Press the CH+/- buttons or PROGRAM NUMBER (0-9) button to choose desired channels (I.E. channel 1).

1
AUTO
BG

2 Press the TUNE menu button, till the TUNING menu shown on the right display on the screen.

TUNE	AUTO
COLOUR	BG
SOUND	VHFL
BAND	OFF
SKIP	0
PROGRAM SEARCH	
FINE TUNE	
AUTO SEARCH	

3 Press the CH+/- buttons to select "SKIP".

4 Press the VOL-/+ buttons to turn the SKIP function "ON".

TUNE	AUTO
COLOUR	BG
SOUND	VHFL
BAND	ON
SKIP	0
PROGRAM SEARCH	
FINE TUNE	
AUTO SEARCH	

5 Press the TUNE button to close the menu. When you use the CH+/- buttons to select channel, this channel will be skipped. However, you can still use the PROGRAM NUMBER buttons to select the skipped channel numbers.

If you want to recover the skipped channel

1 Use the PROGRAM NUMBER buttons to select the channel number to be recovered.

2 Repeat those steps just now.

3 Press the VOL-/+ buttons to turn the SKIP function "OFF".

Convenient picture and sound control functions

Multiple picture modes

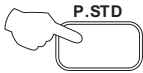

How to select picture modes

You can quickly select the desired picture mode from four preset modes and one customized mode.

Press the P.STD button to select the desired picture quality. Five kinds of picture modes (i.e., "STANDARD", "RICH", "USER", "LISTEN", "SOFT") can be selected in turn.

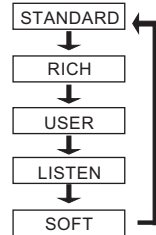

How to customize your own picture status

1 Press the PICTURE menu button, till the PICTURE menu shown on the right display on the screen.



2 Press the CH+/- buttons to select the item to adjusted, then press the VOL-/+ buttons to obtain the desired effect.

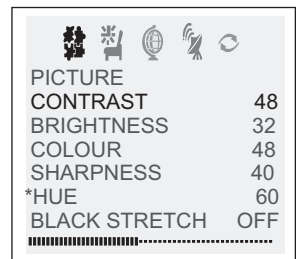
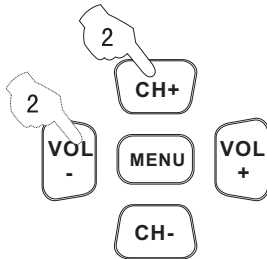

ITEM	Press VOL-	Press VOL+
CONTRAST	Weak	Strong
BRIGHTNESS	Dark	Bright
COLOUR	Shallow	Deep
SHARPNESS	Soft	Sharp
*Hue	lean to purple	lean to green

Note:

The "Hue" item only appears when the colour system is NTSC.

Convenient picture and sound control functions

(Continued)

- Black Stretch-(Automatically Increases the Contrast Rage)
- Noise Reduce - (Picture Noise & Grain Reduction Circuit. Only use on poor reception.)

Black stretch and noise reduce

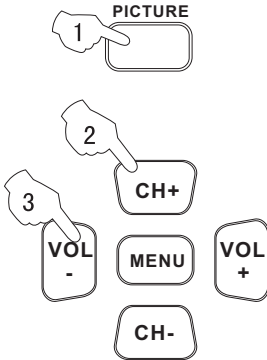

How to select BLACK STRETCH

1 Press the PICTURE menu button , till the PICTURE menu shown on the right display on the screen.

PICTURE	
CONTRAST	48
BRIGHTNESS	32
COLOUR	48
SHARPNESS	40
*HUE	60
BLACK STRETCH	OFF

2 Press the CH+/- button to select "BLACK STRETCH".

PICTURE	
CONTRAST	48
BRIGHTNESS	32
COLOUR	48
SHARPNESS	40
*HUE	60
BLACK STRETCH	ON

3 Press the VOL-/+ buttons to turn the BLACK STRETCH function "ON" or "OFF".

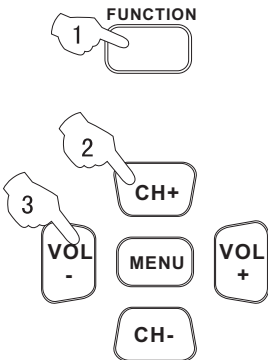

1 Press the FUNCTION menu button , till the FUNCTION menu shown on the right display on the screen.

FUNCTION	
ENGLISH	
BACKGROUND	ON
NOISE REDUCE	ON
FADE	ON
CHILD LOCK	OFF
AVL	ON
CALENDAR	

2 Press the CH+/- buttons to select "NOISE REDUCE".

FUNCTION	
ENGLISH	
BACKGROUND	ON
NOISE REDUCE	OFF
FADE	ON
CHILD LOCK	OFF
AVL	ON
CALENDAR	

3 Press the VOL-/+ buttons to turn the NOISE REDUCE function "ON" or "OFF".

Convenient picture and sound control functions

(Continued)

Mute function



Sound mute

1 Press the MUTE button on the remote control and "MUTE" type face will display on the lower part of the screen. At this time, the sound of the TV set is turned off.

MUTE

2 If you want to recover the sound, press the MUTE button again or directly press the VOL-/+ buttons.

Time functions

Clock setting and timer on/off functions

Clock setting

The clock will only work if the TV set is left turned on or in standby. When the set is disconnected from the power supply or is turned off by the main power on the front panel, the clock loses power and will need to be reset when the power is reconnected.

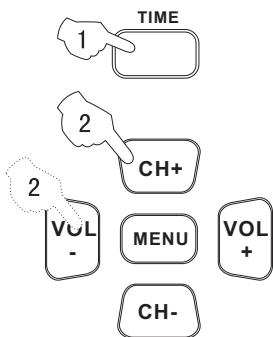

1 Press the TIME menu button, and the TIME menu display on the screen.

2 Press the CH+/- buttons select "CLOCK", then press the VOL -/+ buttons to adjust the time in hour position; press again the CH+/- buttons to select the time in minute position, then press the VOL -/+ buttons to adjust the value of minutes .

TIME	
CLOCK	17:18
ON TIME	18:00
ON PROG	1
OFF TIME	--:--
SLEEP TIMER	0
REMIN TIME	--:--
REMIN PROG	1

On/off timer

Using on/off timer function, the TV set can automatically turn on to a preset program or shut down in a preset time.

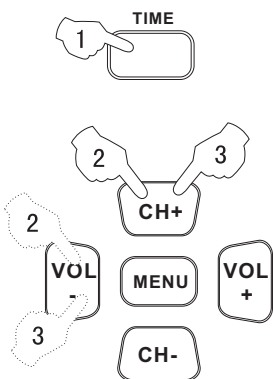

1 Press the TIME menu button to call up the TIME menu on the screen.

2 Press the CH+/- buttons to select "ON TIME", then press the VOL -/+ buttons to set the value in hour position; press again the CH+/- buttons to select the minute position and set the value of the minute.(take 18:00 as an example)

3 Press the CH+/- buttons to select "ON PROG", then press the VOL-/+ or program direct number buttons to select your desired channel (take 8 as an example).

4 Repeat step 1-2 to set OFF TIME.(take 23:00 as an example)

TIME	
CLOCK	17:18
ON TIME	18:00
ON PROG	1
OFF TIME	--:--
SLEEP TIMER	0
REMIN TIME	--:--
REMIN PROG	1

TIME	
CLOCK	17:18
ON TIME	18:00
ON PROG	8
OFF TIME	23:00
SLEEP TIMER	0
REMIN TIME	--:--
REMIN PROG	1

Time functions

(Continued)

Sleep timer and program preset

Sleep timer

The TV set have 18 sections option for sleep timer function (each section has a time interval of 10 minutes) (See right chart):

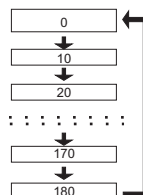

1 Press the TIME menu button, and the TIME menu display on the screen.

2 Press the CH +/- buttons to select "SLEEP TIMER".

3 Press the VOL -/+ buttons to adjust the SLEEP TIMER level.

TIME				
CLOCK				17:18
ON TIME				18:00
ON PROG				8
OFF TIME				23:00
SLEEP TIMER				120
REMIND TIME				--:--
REMIND PROG				1

REMIND PROG function

Program remind timer, that displays an on-screen reminder prompt, when a program on a different channel is due to start.

1 Press the TIME menu button to call up the TIME menu on the screen.

2 Press the CH +/- buttons to select "REMIND TIME", then press the VOL +/- buttons to set the value in hour position; press again the CH +/- buttons to select the minute position, and then set the value of the minute. (take 19:00 as an example)

3. Press the CH +/- buttons to select "REMIND PROG", then press the VOL +/- buttons or the program direct number buttons to set the desired channel (take 18 as an example).

NOTE: For REMIND PROG to operate CHILD LOCK must be turned off.

TIME				
CLOCK				17:18
ON TIME				18:00
ON PROG				8
OFF TIME				23:00
SLEEP TIMER				120
REMIND TIME				19:00
REMIND PROG				1

TIME				
CLOCK				17:18
ON TIME				18:00
ON PROG				8
OFF TIME				23:00
SLEEP TIMER				120
REMIND TIME				19:00
REMIND PROG				18

Set up function

Screen saver and childlock functions

How to start screen saver function

When the BACKGROUND function is ON, the screen will turn automatically as shown "NO SIGNAL" of moving .

NO SIGNAL

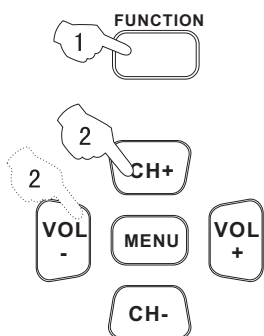

1 Press the FUNCTION menu button, till the FUNCTION menu shown on the right display on the screen.

2 Press the CH+/- buttons to select "BACKGROUND" and press the VOL-/+ buttons to turn the BACKGROUND function "ON" .

FUNCTION	
ENGLISH	
BACKGROUND	ON
NOISE REDUCE	ON
CHILD LOCK	OFF
AVL	ON
CALENDAR	

Child lock function

Enables the TV front control buttons to be locked.

1 Press the FUNCTION menu button, till the FUNCTION menu shown on the right display on the screen.

2 Press the CH+/- buttons to select "CHILD LOCK" and press the VOL-/+ buttons to turn CHILD LOCK function "ON" .

FUNCTION	
ENGLISH	
BACKGROUND	ON
NOISE REDUCE	ON
CHILD LOCK	OFF
AVL	ON
CALENDAR	

NOTE:

All the control panel buttons on the front of the TV are disabled when CHILD LOCK is turned on. The power switch will still turn the TV set off.

Set up function

(Continued)

AVL and calendar functions

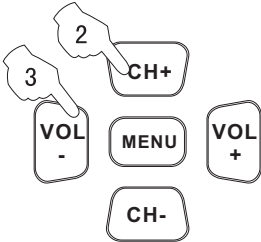
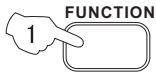

AVL function

1 Press the FUNCTION menu button, till the FUNCTION menu shown on the right display on the screen.

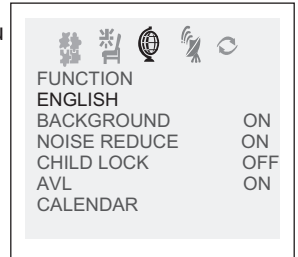

2 Press the CH+/- button to select "AVL" .

3 Press VOL-/+ button to turn the AVL function "ON" or "OFF."

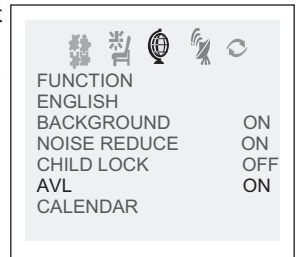

Calendar function

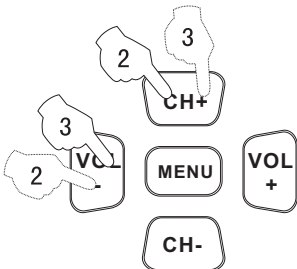
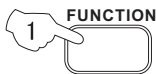

1 Press the FUNCTION menu button, till the FUNCTION menu shown on the right display on the screen.

2 Press the CH+/- button to select "CALENDAR", then press the VOL-/+ buttons to the CALENDAR display on the screen.

3 Press the VOL-/+ buttons to turn the YEAR/MONTH/DAY, press CH+/- buttons to set or adjust the YEAR/MONTH/DAY.

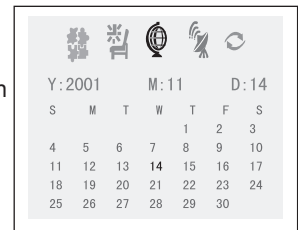
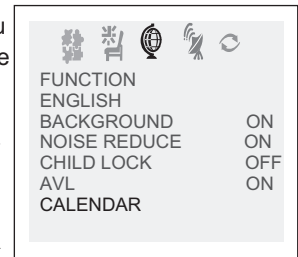

Set up function

(Continued)

Select a language

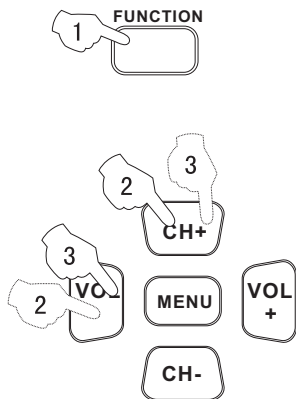

Select a language

1 Press FUNCTION menu button, till FUNCTION menu shown on the right display on the screen.

2 Press the CH+/- buttons to select "ENGLISH".

3 press the VOL-/+ buttons to select the desired language. Then all the items will be displayed in the selected language.

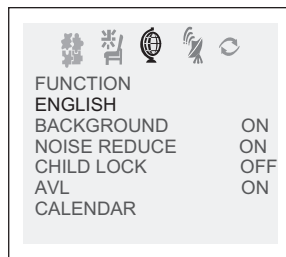

Position exchange functions

Exchange

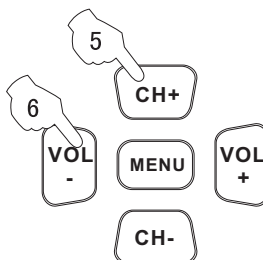
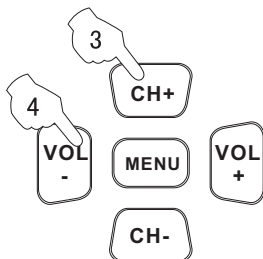
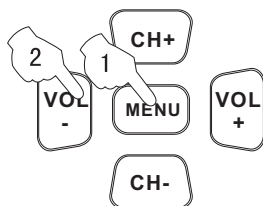

Exchange

This feature enables TV programs that may be on a wrong TV channel number to be swapped/exchanged. This feature is very useful when Automatic Search Tuning has been used, to reallocate the found programs to the correct channel numbers.

1 Press the MENU button till the EXCHANGE menu display on the screen.

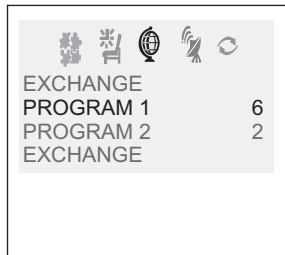

2 Press the VOL-/+ buttons or the PROGRAM NUMBER (0-9) buttons to set PROGRAM 1 TO 6.

3 Press the CH-/+ buttons to select "PROGRAM 2".

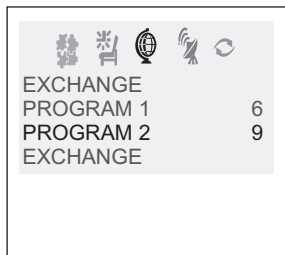

4 Press the VOL-/+ buttons or the PROGRAM NUMBER (0-9) buttons to set PROGRAM 2 TO 9.

5 Press the CH+/- buttons to select "EXCHANGE".

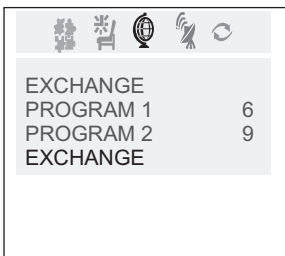

6 Press the VOL-/+ buttons to set "EXCHANGE".

Connecting the TV set to the other video and audio equipment

Connecting to the other video and audio equipment

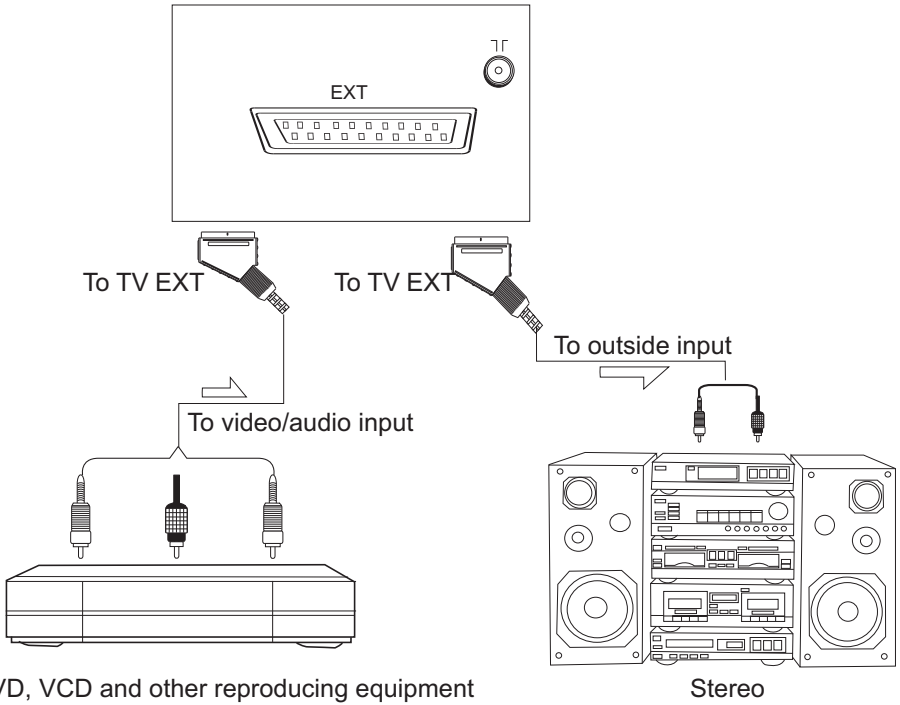

















DVD, VCD and other reproducing equipment

Stereo

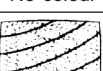
Troubleshooting guide

- To assist in location possible faults use help guide below.

BREAKDOWN PHENOMENON		CHECKING
PICTURE	SOUND	
 <p>Picture with snow</p>	 <p>Noise</p>	The aerial direction and connection
 <p>Double or Triple Image</p>	 <p>Normal</p>	This is called ghosting which can be minimized with an outside aerial, and good quality cable and terminations. Altering the aerial direction can also minimize this effect.
 <p>Disturb</p>	 <p>Noise</p>	Electrical interference which can be caused by cars, motorbikes etc, Fluorescent lamps and dirty insulators on overhead power cables.
 <p>Normal</p>	 <p>No sound or 1 speaker no sound</p>	<ol style="list-style-type: none"> 1. Volume Sound mute. 2. Only 1 speaker has no sound. Press S.STD button to choose USER mode, then check whether the BALANCE item value in SOUND menu equal to 0. Adjust the BALANCE item in SOUND menu as you wish in USER mode.
 <p>No Picture</p>	 <p>No sound</p>	Ensure that the power supply is connected to the TV set and turned on. Also ensure that the TV set is not in "Listen Mode" or that the brightness and contrast are not turned down.
 <p>No colour</p>	 <p>Normal volume</p>	Adjust colour control
 <p>Scramble</p>	 <p>Normal or Weak Volume</p>	Adjust channel again
 <p>Colour Spot</p>	 <p>Normal volume</p>	Colour Purity fault which can be caused by moving the TV set, placing magnets near the TV screen or turning on/off house hold appliances such as vacuum cleaners near the TV set. Turn the TV off with the mains power switch for 15 minutes. When the power is turn on again the TV set will automatically degauss the picture. In server cases leave the TV set turned off overnight.

Note:

- 1.If the fault can not be repaired using the above guide consult with your local authorized service center.
- 2.The TV set must only be repaired by a qualified registered service person. Never attempt to remove the back cover as the TV set has dangerous voltages in side that may cause a fatality or fire.
3. The cabinet may produce the occasional "snapping sound" This is normal and caused by the materials in the cabinet expanding with room temperature changes.

Specifications

Colour system	PAL, SECAM	
	BG, DK, I	
Picture tube	1407	14"color picture tube
	21F9D, 21F9D-P, 21T9D, 21T9D-P	21"colour picture tube
Sound output power	2W (not distortional)	
Power requirements	1407	~ 110V-250V 50Hz/60Hz
	21F9D, 21F9D-P, 21T9D, 21T9D-P	~ 180V-250V 50Hz/60Hz
Power consumption	1407	≤ 60W
	21F9D, 21F9D-P, 21T9D, 21T9D-P	≤ 70W
Dimension	1407	342 (Width) x371 (Depth) x318 (Height) (mm)
	21F9D, 21F9D-P, 21T9D, 21T9D-P	603 (Width) x475 (Depth) x430 (Height) (mm)
Accessories	Remote control	X1
	Owner's manual	X1
	Battery(AAA)	X2

*The design and specifications may be changed without notice.

Haier

01
0090506138B

Free Manuals Download Website

<http://myh66.com>

<http://usermanuals.us>

<http://www.somanuals.com>

<http://www.4manuals.cc>

<http://www.manual-lib.com>

<http://www.404manual.com>

<http://www.luxmanual.com>

<http://aubethermostatmanual.com>

Golf course search by state

<http://golfingnear.com>

Email search by domain

<http://emailbydomain.com>

Auto manuals search

<http://auto.somanuals.com>

TV manuals search

<http://tv.somanuals.com>