

Haier

COLOR TV RECEIVER

OWNER'S MANUAL

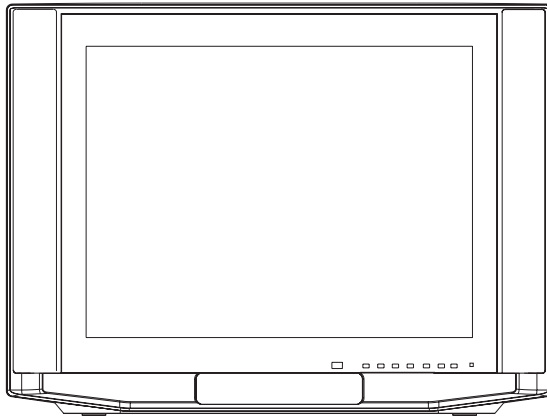

Please READ this manual carefully before operating the unit, and keep it for future reference.

The Owner's Manual for the Following Models:
29F5D, 34F5D

* For your enjoyment of this TV set, please read this manual carefully and keep it good for future reference.

CONTENTS

Before Operation

Warning and cautions.....	2
Installation.....	3
Antenna connection.....	3
Preparation for the remote control.....	3
Position of Button and Plug-ins.....	4
Front and side panel.....	4
Back panel.....	4
Function button of the remote control.....	5
The screen display menu.....	6

Basic Operation

Switch on/off the TV set.....	7
Watching TV programs.....	8
Watching TV program.....	8
Program swap and auto scan functions.....	9
Tune.....	10
Auto search.....	10
Search.....	11
Fine tune and Program lock functions.....	12
Skip unnecessary channel.....	13
Exchange programs.....	14
Picture adjusting.....	15
Select the picture modes and set the picture quality.....	15
Color Temp function.....	16
3A Optimize and 3DNR functions.....	17
Comb filter and Layer En./Color En. Functions.....	18
Sound adjusting.....	19
Select the sound modes and set the sound quality.....	19
Equalizer and mute functions.....	20
Time setup function.....	21
Set current time and on/off time functions.....	21
Remind Program Function.....	22
Setup function.....	23
Select the menu Language and Screensaver functions.....	23
Select Switch on mode and HDM scan function.....	24
Tilt function and setting Transparency menu.....	25
Setting the Lock.....	26
Change your password.....	26
Setting the Lock.....	27
Others functions.....	28
Calendar, picture still and zoom functions.....	28
Setting and Using Favorite programs, Setting Sleep Timer.....	29
VGA input adjustment.....	30
Multi-Media Player system.....	31
Multi-Media Player Preparation.....	31
To operate the menu.....	33
Multi-Media player.....	34
Copy file function.....	38
Setup functions.....	39

Technical operation

External connections.....	40
Video/Audio output connection, VGA input.....	40
Video/Audio input connection.....	41

Others

Trouble shooting.....	42
Specifications.....	43

Warning and Cautions

1. When you clean the TV set, please pull out the power plug from AC outlet. Don't clean the cabinet and the screen with benzene, petrol and other chemicals.



4. Do not place the TV set near rain or moisture as it may cause an electric shock, or the TV set to catch fire. The TV set must only be used in dry indoor locations.

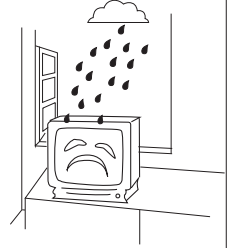

2. In order to prolong the using life of the TV set, please place it in a well-ventilated location.

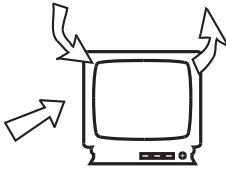

5. The back cover must only be removed by a registered electrical service person. Removing the back cover may result in electric shock, fire or damage to the TV set.

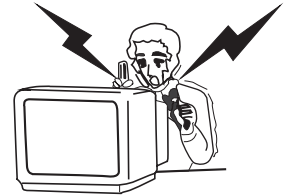

3. Don't place the TV set in direct sunlight or near a heat source.

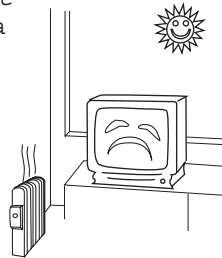

6. If the TV set is not going to be used for a long time, or there is a severe thunder & lightning storm, it is recommended that the TV set be disconnected from the AC power outlet and the aerial plug removed.

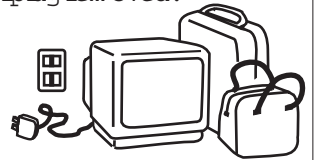

Explanation on the display tube

Should the picture tube require cleaning, disconnect the power and use a dry soft cotton cloth. Do not use any cleanser or abrasive cloths.

Installation

Antenna connection

Generally speaking, to enjoy a clearer picture, we recommend that you use a CATV system or an outdoor antenna. In different places, the suitable antenna type and position are different.

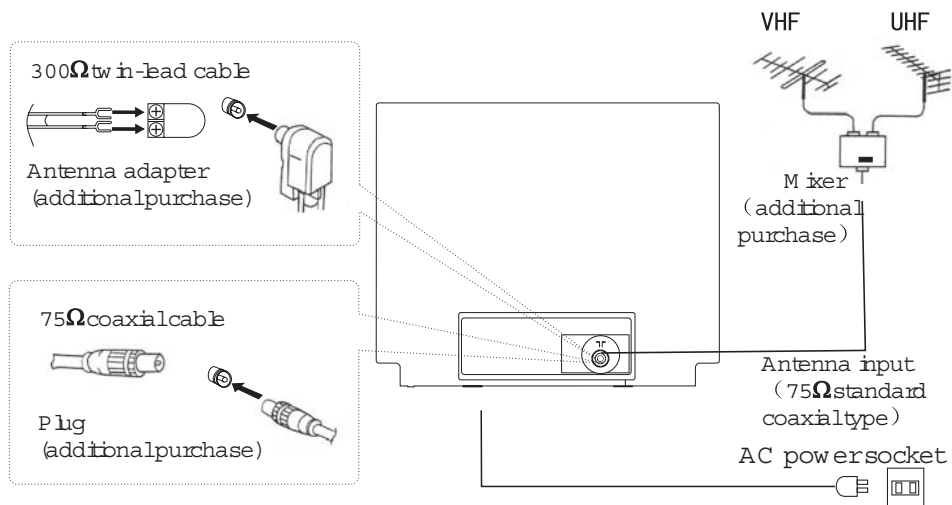

Note:

* It is recommended that you'd better use 75Ω coaxial cable to remove the disturbance caused by air wave.

* Don't bind antenna cable and electric wire together.

* the plug type may vary depending on the model.

Preparation for the remote control

Battery installation

Take off the battery compartment cover. Place two AA batteries, make sure that battery polarity matches with the +/− mark inside the battery compartment.

Operation notes for the remote control unit

- Under normal conditions, the life time of batteries is one year.
- If you don't intend to use the unit for a long period or the electricity of the batteries is used up, remove the batteries to prevent batteries acid from leaking into the battery compartment.
- Never place batteries in a fire.
- Avoid dropping the remote control and/or getting it wet.

Position of Buttons and Plug-ins

Front and Side panel

Side AV terminal

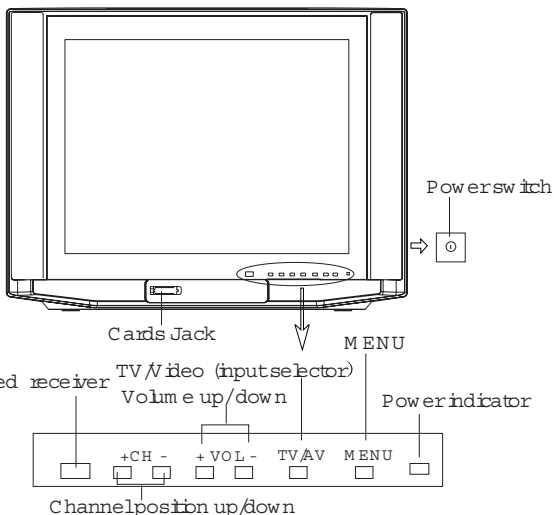
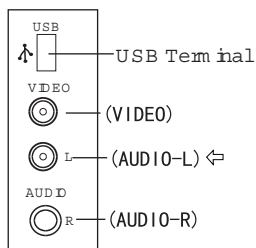

Note:

The cabinet and buttons of TV is only for reference.

Back panel

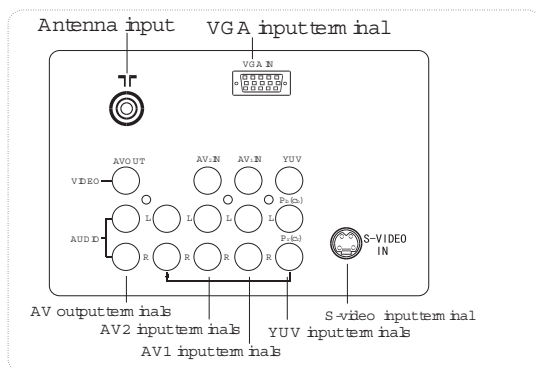

S-video input terminal: Special video (S-VIDEO) AUDIO: L/MONO Track (L/MONO) R Track (R)
 AV output terminals: VIDEO AUDIO: L/MONO Track (L/MONO) R Track (R)
 AV2 input terminals (MONITOR): VIDEO AUDIO L/MONO Track (L/MONO) R Track (R)
 AV1 input terminals (MONITOR): VIDEO AUDIO L/MONO Track (L/MONO) R Track (R)
 DVD component terminals:
 Interlaced signal (Y, Cb, Cr) AUDIO: L/MONO Track (L/MONO) R Track (R)
 Progressive signal (Y, Pb, Pr) AUDIO: L/MONO Track (L/MONO) R Track (R)
 HDTV input terminals: Y, Pb, Pr terminal AUDIO: L/MONO Track (L/MONO) R Track (R)

Note

- When the AV2 terminal, USB terminal or the side AV terminal can not be connected at the same time.
- When the side AV is connected, please select the AV 2 terminal.

Function Buttons of the Remote Control

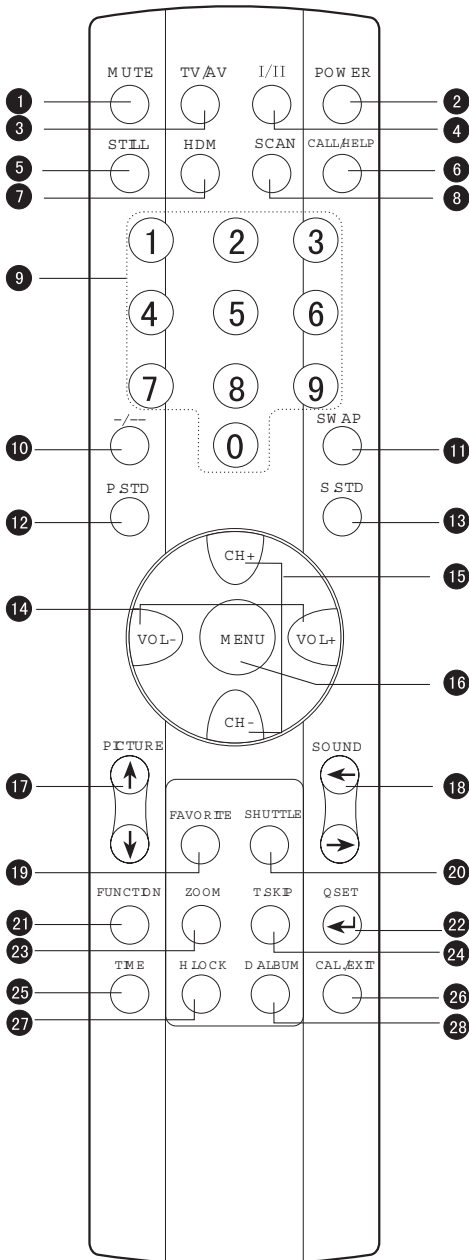

Function buttons of the remote control

- 1 Mute button
To eliminate the sound of the programs
- 2 DC standby and power button
- 3 TV and AV exchange button
A changeover between TV and other input signals like AV
- 4 I/II select button
- 5 Picture still button
- 6 Screen call/help button
- 7 HDM menu call button
- 8 Program scan button
- 9 Direct select button
Select a TV channel directly
- 10 Digital selection button
Changeover from one digital, two digital and three digital
- 11 Program swap button
- 12 Picture mode selection button
- 13 Sound mode selection button
- 14 Volume adjustment button
- 15 Program adjustment button
- 16 Menu call/select button
Select menu, call and exit
- 17 Picture menu call/game direction select
- 18 Sound menu call/game direction select
- 19 Favorite program button
- 20 (No available)
- 21 Function menu call
- 22 QSET button (No available)
- 23 Zoom select button
- 24 Time skip button (No available)
- 25 Time menu call button
- 26 Calendar/Exit button
- 27 Hotel back button
- 28 Digital album (No available)

The Screen Display Menu

For your convenience of operation, here lists the screen display menus of this model as your reference.

Picture menu

MENU	
Picture	Picture Mode ◀ Standard ▶
Sound	Brightness 50
Tune	Contrast 50
Setup	Color 50
Timer	Hue 0
	Sharpness 30
	ColorTemp. ◀ Cool ▶
	Advance ▶

Sound menu

MENU	
Picture	Sound Mode ◀ Standard ▶
Sound	3D Mono ◀ Off ▶
Tune	SRS D'abg ◀ Off ▶
Setup	Tmbass ◀ Off ▶
Timer	Woofer ◀ Off ▶
	Balance 0
	Equalizer ▶

Tune menu

MENU	
Picture	Exchange ▶
Sound	Program edit ▶
Tune	Search ▶
Setup	Auto Search ▶
Timer	Quick Search ▶

Setup menu

MENU	
Picture	Language ◀ English ▶
Sound	Screen Saver ◀ On ▶
Tune	Curtain I ▶
Setup	ColorSys. ◀ PAL50 ▶
Timer	HDM scan ◀ 100Hz ▶
	Transparency On
	Tit 0

Timer menu

MENU	
Picture	CurrentTime 122 7
Sound	Off Time -- --
Tune	On Time -- --
Setup	On program 10
Timer	Rem ind time -- --
	Rem ind program --
	Sleep Time ◀ Off ▶

Lock menu

Lock Set	
Change Password	
New PWD	----
Confirm PWD	----
Confirm	▶
Lock	◀ Off ▶
ChannelLock	◀ Off ▶

Note:

When the TV set is powered on, there might be different from what have been illustrated above. Please do some adjustments as follows to meet your needs.

1. Press the MENU button, and then press CH +/- buttons to select the menu in the main menu: PICTURE, SOUND, TUNE, SETUP and TIMER. Of course, you may select these menus directly by pressing the PICTURE, SOUND, TIME and FUNCTION buttons on the remote control.
2. If it is not in sub-menu, press the VOL +/- buttons to enter the sub-menu.
3. Then press the CH +/- to select the desired item, press the VOL +/- buttons to adjust the numerical value. After that, press the MENU button to return the main menu.
4. If you want exit the menu, press the MENU button repetitiously.

Switch on/ off the TV set

- In the following, the methods of using power switch and remote control to switch on/off power supply for the TV set will be explained.

Switch on/off the TV set

Switch on/off the TV set

1. Connect the power supply wire. Then press the power switch button, the power indicator will light, in several seconds the picture will display on the screen.

2. If the TV is in the state of standby, press the POWER button or the CH +/- buttons on the remote control.

Note:

1. Press the CH +/- buttons which is on the TV set to get out of the standby state when the remote control is not in use.

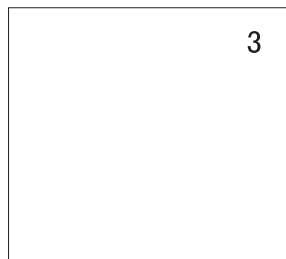

2. Press the POWER button on the remote control to the standby mode.

3. Press the power button on the TV set to completely power off the TV.

4. To eliminate the magnetization completely, the TV set de-gausses automatically. There is the sound of PENG, it is natural.

Automatic standby function

If no signal has been received, and after five minutes, it will stand by automatically.



Watching TV Programs

Watching TV programs

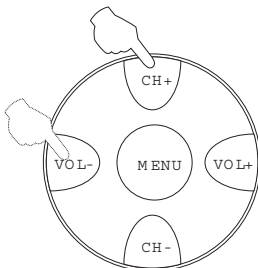
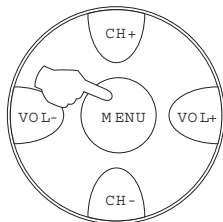
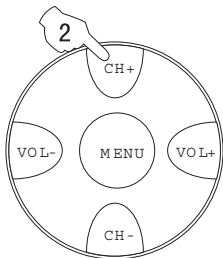
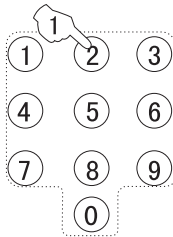

How to select the TV program

Select the desired program

- Use the direct number selection button
 - Press the button from 0-9 to select a one-figure channel.
 - If you want to select a double figures channel, press the figure-selection button and change it into two-figure mode, then press the number of the channel.
 - If you want to select a three figures channel, press the figure-selection button and change it into three-figure mode, then press the number of the channel.
- Use the CH +/- buttons
 - Press the CH+ button to select the channel of the larger number.
 - Press the CH- button to select the channel of the smaller number.

Select the desired sound

Press the VOL +/- buttons to adjust the volume to your need.

If the colour or sound of a certain channel is abnormal

If the TV set you bought is abnormal in colour or sound in a certain channel, it might be because the colour or sound system has been set in properly. You may follow the instruction below to adjust it. Press the MENU button, then press CH +/- buttons to select function menu, and you can see the form. Then press VOL+ button to enter sub-menu.

MENU	
Picture	Language ◀ English ▶
	Screen Saver ◀ On ▶
Sound	Curtain ◀ 1 ▶
	Colorsys. ◀ PAL50 ▶
Tune	HDM scan ◀ 60Hz ▶
Setup	Transparency On
Timer	Title 0

- If the colour of the picture is abnormal
Press the CH +/- buttons to move the indicator to "Color Sys.", and press the VOL +/- buttons to select the proper color.

- If the sound is abnormal
Refer the above steps to enter the Program edit menu. Press the CH +/- buttons to move the indicator to "Sound Sys.", and press the VOL +/- buttons to select the proper sound.

Program edit	
Program NO.	2
Skip	◀ Off ▶
Lock	◀ Off ▶
Sound Sys.	◀ BG ▶
Fine tune	<144.20MHz>

Watching TV Programs (continued)

- Swap function enables quick swap to the last watched program .

Program swap and auto scan functions



Program swap

1. Suppose the channel number you used just now is 8 and the channel number you are using is 18 (as shown in the figure).

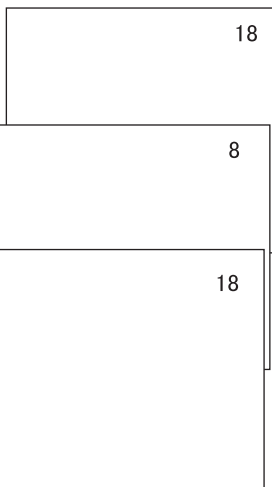

2. If you want to return to the last watched program channel 8, you can simply press the SW AP button.

3. If you want to return to channel 18, press the button again. Through this function, you can easily change between the channel you are using and the channel you used last time.



Auto program scan

1. Press the SCAN button to scan through all the memorized TV channels.

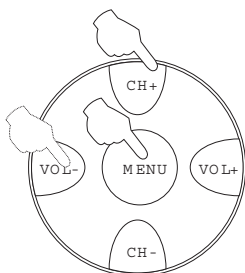
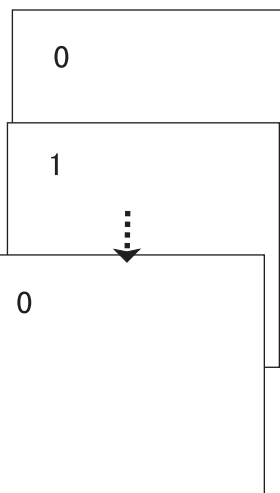

2. When it is the program that you desired, and press the MENU button to confirm .

Tune

- The TV set has three methods to set the channels, which are Auto search, Search and Fine tune.
- In this section, how to use the remote control to set the channels is explained. You can also use the buttons on the TV set to set channel.

Auto search

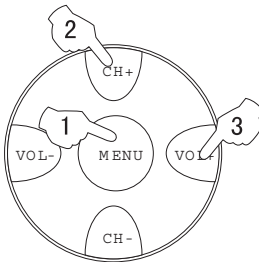

Auto search

1. Press the MENU button to display the menu, then press CH+/- buttons to select TUNE menu, press VOL+ button to enter.

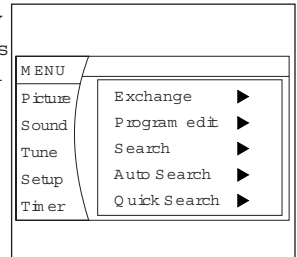

2. Press the CH+/- buttons to move the indicator to "Auto Search".

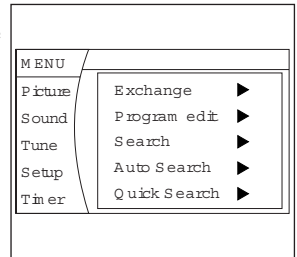

3. Press the VOL+ button, and "Auto Search" mode will work. The TV set will search automatically all available programs, after search is finished, all available programs will be stored in tun.

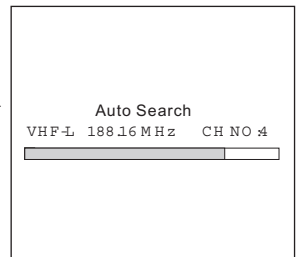

- If you want to stop the search, just press the MENU button.
- The order of the automatic search is due to the frequency of the program, generally speaking, it is used only the first time you search the program, and after the order of the program has been made, you don't have to use this function, otherwise the order of the program will be mixed.

After searching (Continued)

- Press the CH+/- buttons to check channels.
- If the color or sound is abnormal in a certain channel, it may be because that the color or sound system has not been set properly, then, you may adjust it to proper system (Refer to page 8).

Tune (Continued)

Search

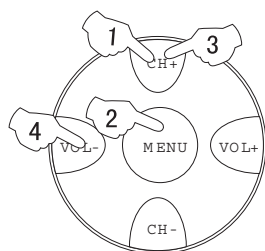

Search

1. Press the CH +/- buttons or Direct select button to select the desired channel number.

1

2. Press the MENU button to display the menu, then press CH +/- buttons to select TUNE menu, press VOL+ button to enter.

3. Press the CH +/- buttons to move the indicator to "Search", and then press the VOL+ button to enter the SEARCH menu.

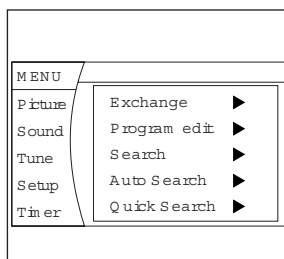

4. Press the VOL+ or VOL- buttons, the TV set will begin to search up or down, when the TV set has searched a program, the TV set will stop searching. If the program is not the one you need, you can press the button again, let the TV set continue to search until it has searched the TV signal you need.

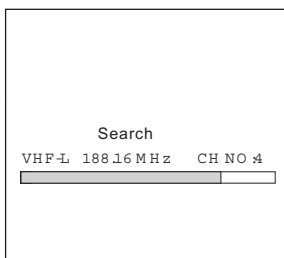

CALL/HELP



Note:

Usually, five seconds after the channel has been changed, the channel number will disappear automatically. If you want to know which channel you are watching, just press the CALL/HELP button once.

Tune (Continued)

Fine Tune and Program Lock functions

Fine Tune

If the picture and/or sound are poor, try using the FINE TUNE feature. Do not use this feature unless reception is poor.

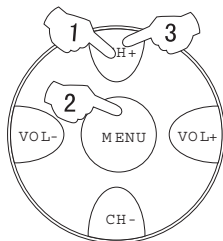

1. Press the CH +/- buttons or Direct select button to select the desired channel number. (For example, the channel 1.)

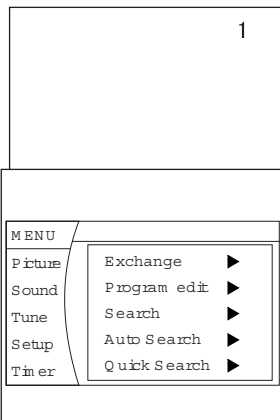

2. Press the MENU button to display the menu, then press CH +/- buttons to select TUNE menu, press VOL+ button to enter.

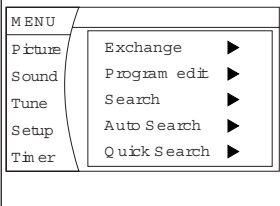

3. Press the CH +/- buttons to move the indicator to "Program edit", then press the VOL+ button to sub-menu.

4. Press the CH +/- buttons to move the indicator to "Fine Tune".

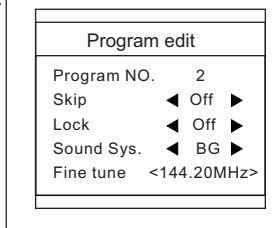

5. Press the VOL+ button to enter the Fine Tune Menu, and then the VOL- button to search downwards or the VOL+ button to search upwards until it has searched the TV signal you need.

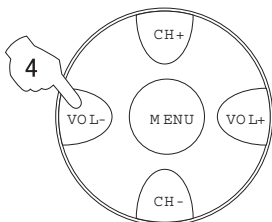

Program Lock buttons

If the program Lock and the program Lock of the Lock Set are ON, the screen is black and LOCK will shown. The program is locked.

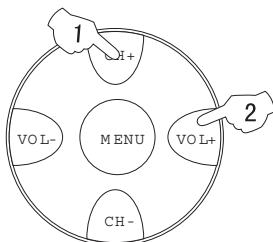

1. Repeat the steps 1-4 of Fine Tune to select the Lock item.

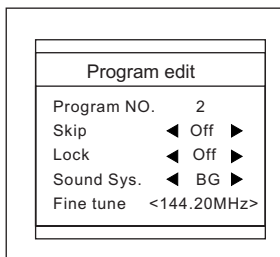

2. Press the VOL+ button to turn the Lock function to "On".

3. Press the H Lock button to turn the Program Lock function to "On" (Refer to page 27), then the screen

is black. After setting the Program Lock to On, the Lock of the Program Edit menu will fail.

Tune (Continued)

Skip unnecessary channel

Skip unnecessary channel

The Program skip feature enables you to skip/hide programs that you do not wish to be displayed when using the CH +/- buttons. These channels will still be displayed by directly using the channel number buttons on the remote control.

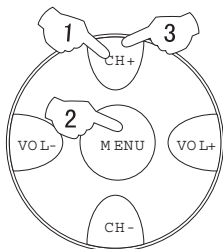

1. Press the CH +/- buttons or Direct select button to select the desired channel number. (For example, the channel 1.)

1

2. Press the MENU button to display the menu, then press CH +/- buttons to select TUNE menu, press VOL+ button to enter.

MENU	
Picture	Exchange ▶
Sound	Program edit ▶
Tune	Search ▶
Setup	Auto Search ▶
Timer	Quick Search ▶

3. Press the CH +/- buttons to move the indicator to "Program edit", then press the VOL+ button to sub-menu.

4. Press the CH +/- buttons to move the indicator to "Skip".

Program edit	
Program NO.	2
Skip	◀ Off ▶
Lock	◀ Off ▶
Sound Sys.	◀ BG ▶
Fine tune	<144.20MHz>

5. Press the VOL +/- buttons to turn the Skip function to "ON".

6. Press the MENU button to exit the menu display.

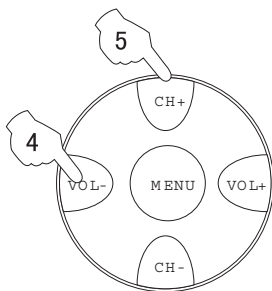

If you want to recover the skipped channel

1. Use the Channel Selection buttons to select the number of the channel to be recovered.
2. Repeat those steps just now.
3. Press the VOL +/- buttons to turn the SKIP function OFF.

Tune (Continued)

Exchange Programs

Exchange Programs

This feature enables TV programmes that may be on a wrong program number to be moved to another number.

This feature is very useful when Automatic Search Tuning has been used because programmes are stored in the order they are found, which is usually not the desired order.

When organising, it is best to start from the lowest programme number first.

1. Press the MENU button to display the menu, then press CH + / - buttons to select TUNE menu, press VOL + button to enter.

2. Press the CH + / - buttons to move the indicator to "Exchange".

3. Press the VOL + button to sub-menu.

4. Press the VOL - / + buttons to set the Current Program to 3.

5. Press the CH + / - buttons to move the indicator to "Exchange Program", then press the VOL - / + buttons to set the Exchange Program to 9.

6. Press the CH + / - buttons to move the indicator to "Exchange", press the VOL + button to confirm.

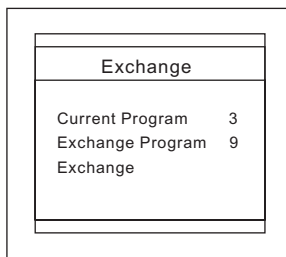
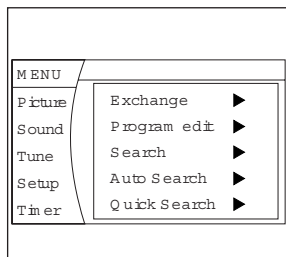
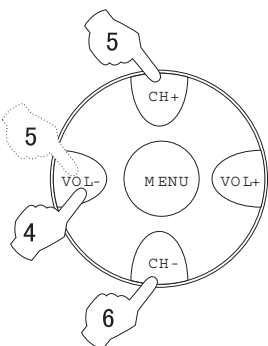
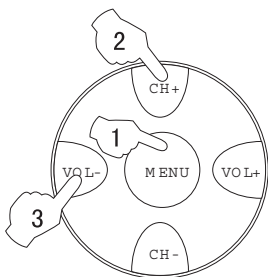

Picture Adjusting

Select the picture modes and set the picture quality



How to select the picture modes

You can quickly select the desired picture mode from four preset modes and one customized mode.

Press the P STD button to select the desired picture quality.

MODE	PICTURE QUALITY
Standard	Medium color and brightness
Soft	Low color and brightness
User	Set by yourself
Listen	(No pictures)
Rich	Bright color

Set the picture quality

When the Picture Mode is User mode, you can set the picture quality.

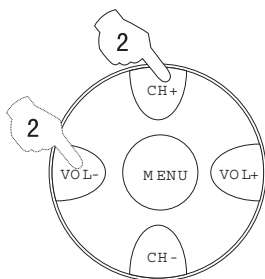
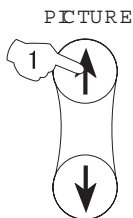

1. Press the PICTURE button, the Picture menu will appear on the screen.

2. Press the CH +/- buttons to move the indicator to the desired option (For example, Contrast), then press VOL +/- buttons to set the desired quality. Press the PICTURE button to exit the Picture menu.

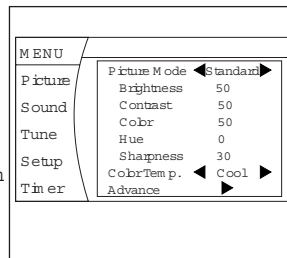

Option	Press VOL- button	Press VOL+ button
Brightness	Dark	Bright
Contrast	Weak	Strong
Color	Light	Thick
Sharpness	Soft	Sharp

Tip: HUE option is available only in N color system.

Picture Adjusting (Continued)

Color Temp Function

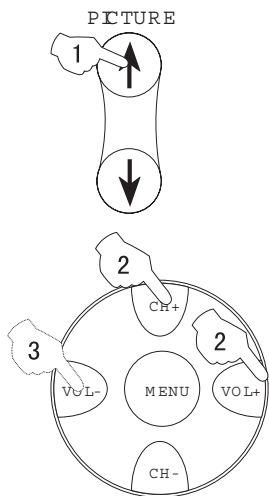

Color Temp Function

1. Press the PICTURE button, the Picture menu will appear on the screen.

2. Press the CH +/- buttons to move the indicator to "ColorTemp".

3. Press the VOL +/- buttons to select "Cool", "Warm" or "Standard".

MENU	
Picture	Picture Mode ◀ Standard ▶
Brightness	50
Sound	Contrast 50
Tune	Color 50
Setup	Hue 0
Timer	Sharpness 30
	ColorTemp. ◀ Cool ▶
	Advance ▶

Picture Adjusting (Continued)

3A Optimize and 3DNR Functions

3A Optimize Function

1. Press the PICTURE button, the Picture menu will appear on the screen.

MENU	
Picture	Picture Mode ◀ Standard ▶
Sound	Brightness 50
	Contrast 50
	Color 50
Tune	Hue 0
	Sharpness 30
Setup	ColorTemp. ◀ Cool ▶
Timer	Advance ▶

2. Press the CH +/- buttons to move the indicator to "Advance", then press the VOL+ button to sub-menu.

3. Press the CH +/- buttons to move the indicator to "3A Optimize".

MENU	
Picture	3A Optimize ◀ On ▶
Sound	Comb filter ◀ Off ▶
Tune	3DNR ◀ Off ▶
Setup	Layeren. ◀ Off ▶
Timer	Coloren. ◀ Off ▶

4. Press the VOL +/- buttons to select "On", "Off" or "Window".

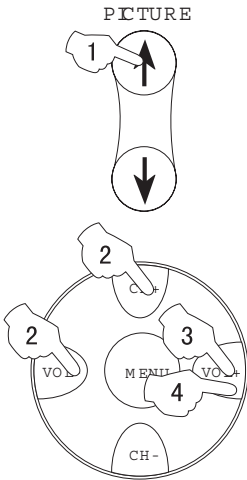

3DNR Function

1. Press the PICTURE button, the Picture menu will appear on the screen.

MENU	
Picture	Picture Mode ◀ Standard ▶
Sound	Brightness 50
	Contrast 50
	Color 50
Tune	Hue 0
	Sharpness 30
Setup	ColorTemp. ◀ Cool ▶
Timer	Advance ▶

2. Press the CH +/- buttons to move the indicator to "Advance", then press the VOL+ button to sub-menu.

3. Press the CH +/- buttons to move the indicator to "3DNR".

4. Press the VOL +/- buttons to select the desired item.

MENU	
Picture	3A Optimize ◀ On ▶
Sound	Comb filter ◀ Off ▶
Tune	3DNR ◀ Off ▶
Setup	Layeren. ◀ Off ▶
Timer	Coloren. ◀ Off ▶

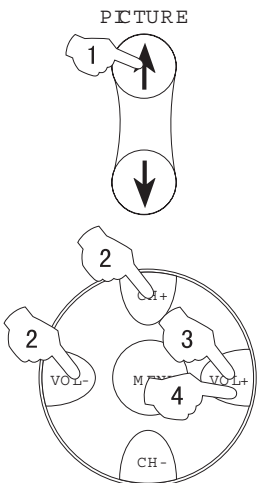

Picture Adjusting (Continued)

Comb filter and Layer En./Color En. Functions

Comb filter Function

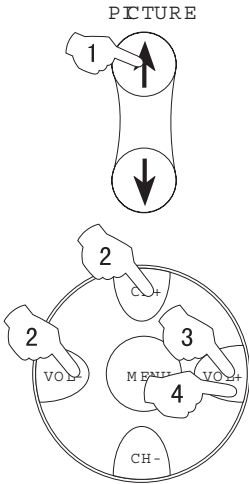

1. Press the PICTURE button, the Picture menu will appear on the screen.

2. Press the CH +/- buttons to move the indicator to "Advance", then press the VOL+ button to sub-menu.

3. Press the CH +/- buttons to move the indicator to "Comb filter".

4. Press the VOL +/- buttons to select "On" or "Off".

MENU	
Picture	Picture Mode ◀ Standard ▶
	Brightness 50
Sound	Contrast 50
	Color 50
Tune	Hue 0
	Sharpness 30
Setup	Color Temp. ◀ Cool ▶
Timer	Advance ▶

MENU	
Picture	3A Optimize ◀ On ▶
Sound	Comb filter ◀ Off ▶
Tune	3DNR ◀ Off ▶
Setup	Layeren. ◀ Off ▶
Timer	Coloren. ◀ Off ▶

Layer En./Color En. Functions

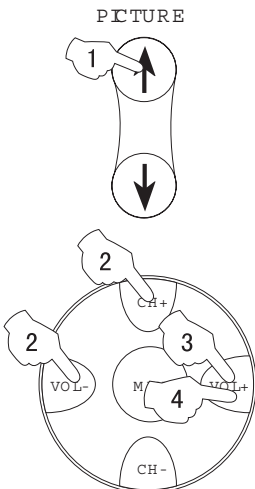

1. Press the PICTURE button, the Picture menu will appear on the screen.

2. Press the CH +/- buttons to move the indicator to "Advance", then press the VOL+ button to sub-menu.

3. Press the CH +/- buttons to move the indicator to "Layeren." or "Coloren.".

4. Press the VOL +/- buttons to select "On" or "Off".

MENU	
Picture	Picture Mode ◀ Standard ▶
	Brightness 50
Sound	Contrast 50
	Color 50
Tune	Hue 0
	Sharpness 30
Setup	Color Temp. ◀ Cool ▶
Timer	Advance ▶

MENU	
Picture	3A Optimize ◀ On ▶
Sound	Comb filter ◀ Off ▶
Tune	3DNR ◀ Off ▶
Setup	Layeren. ◀ Off ▶
Timer	Coloren. ◀ Off ▶

Sound Adjusting

Select the sound modes and set the sound quality



How to select the sound modes

You can quickly select the desired sound mode from three preset modes and one customized mode.

Press the S STD button to select the desired picture quality. Four kinds of sound modes can be selected in turn.

Sound Mode	Sound quality
Standard	Standard
News	Speech
User	You can set it by yourself
Music	Musical

Set the sound quality

When the Personal mode is selected, you can customize the sound quality.

1. Press the SOUND button, the Sound menu will appear on the screen.

2. Press the CH+/- buttons to move the indicator to the desired option, then press VOL+/- buttons to set the desired quality. Press the SOUND button to exit the Sound menu.

MENU	Setting
Picture	Sound Mode ◀ Standard ▶
	3D Mono ◀ Off ▶
Sound	SRS D ãbg ◀ Off ▶
	Trubass ◀ Off ▶
Tune	W oof er ◀ Off ▶
Setup	Balance 0
Timer	Equalizer ▶

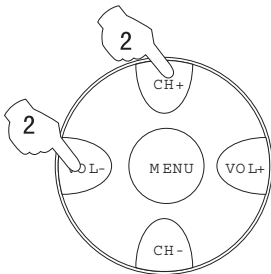
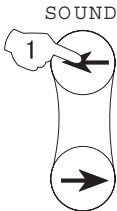

Adjusting the Balance item

Option	Press VOL- button	Press VOL+ button
BALANCE	R track down	L track down

Adjusting the Special items

Option	Setting "On"
3D Mono	3D dynamic surround
SRS D ãbg	SRS D ãbg
Trubass	Enhance bass
W oof er	Enhance woofer

Sound Adjusting (Continued)

Equalizer and Mute functions

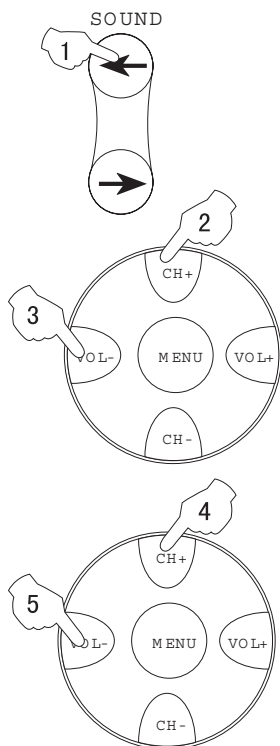

Equalizer function

1. Press the SOUND button, the Sound menu will appear on the screen.
2. Press the CH+/- buttons to move the indicator to "Equalizer".
3. Press the VOL+ button to sub-menu.
4. Press the VOL-/- buttons to select the desired item.
5. Press the VOL+/- buttons to adjusting.

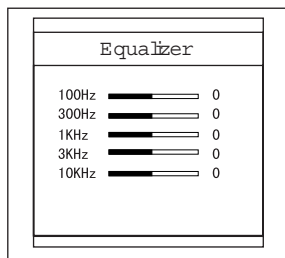
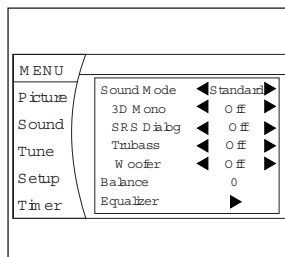

Tip: The Equalizer can be adjusting only for the personal mode.

How to use the Mute function

When you want to listen to the sound nearby, or when you are answering the telephone, or talking with your friends, you may use the mute function.

1. Press the MUTE button once, a sign of mute will appear on the screen, the sound will be eliminated completely.



2. Press the VOL+/- buttons or press the MUTE button again, and the sound will be recovered.

Time Set Up Function

- This model has time set function such as On/Off Time, Sleep and Rem ind Time, etc.
- The unit of the TIME menu is minute.

Set current time and On/Off Time functions

Set current time

When this function is used, please first check whether the clock is in accordance with your local time; if not, you can follow the instructions to adjust it.

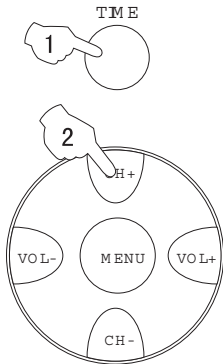

1. Press the TME button, the Time menu will appear on the screen.

2. Press the CH+/- buttons to move the indicator to "Current Time".

Tips:

- The available option is green.
- Press the VOL-/+ buttons to select the desired item.
- Press the CH+/- buttons to adjust the value.
- After setting the Current time, press MENU button to confirm.

MENU	
Picture	Current Time 12: 7
Sound	Off Time --: --
Tune	On Time --: --
Setup	On program 10
Timer	Rem ind time --: --
	Rem ind program ---
	Sleep Time ◀ Off ▶

On/Off Time function

The TV set can be powered on/off at a preset time and it can start with a program you have preset.

Here take On Time function for example. The Off Time function is same with it.

1. Press the TME button, the Time menu will appear on the screen.

2. Press the CH+/- buttons to move the indicator to "On Time".

Tips:

- The available option is green.
- Press the VOL-/+ buttons to select the desired item.
- Press the CH+/- buttons to adjust the value.
- After setting the On Time, press MENU button to confirm.

MENU	
Picture	Current Time 12: 7
Sound	Off Time --: --
Tune	On Time 18: 00
Setup	On program 10
Timer	Rem ind time --: --
	Rem ind program ---
	Sleep Time ◀ Off ▶

3. Press the CH+/- buttons to move the indicator to "On Program", then press the VOL-/+ buttons to adjust (For example, 10).

4. Repeat step 1-2 to turn OFF TIME. (take 23:00 as an example)

MENU	
Picture	Current Time 12: 7
Sound	Off Time 23: 00
Tune	On Time 18: 00
Setup	On program 10
Timer	Rem ind time --: --
	Rem ind program ---
	Sleep Time ◀ Off ▶

Note:

This function will only be available when the TV set is in the mode of standby.

Time Set Up Function (Continued)

Rem ind Program Function

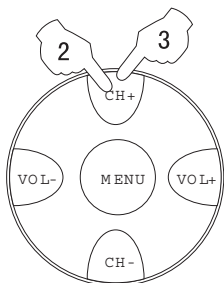

Rem ind Program Function

With Rem ind Program function, the TV set can automatically change a preset program in a preset time.

1. Press the TIME button, the Time menu will appear on the screen.

MENU	
Picture	Current Time 12: 7
Sound	Off Time 23: 00
	On Time 18: 00
Tune	On program 10
Setup	Rem ind time --: --
	Rem ind program ---
Timer	Sleep Time ◀ Off ▶

2. Press the CH +/- buttons to move the indicator to "Rem ind Time".

Tips:

- The available option is green.
- Press the VOL +/- buttons to select the desired item.
- Press the CH +/- buttons to adjust the value.
- After setting the Rem ind Time, press MENU button to confirm.

MENU	
Picture	Current Time 12: 7
Sound	Off Time 23: 00
	On Time 18: 00
Tune	On program 10
Setup	Rem ind time 19: 00
	Rem ind program ---
Timer	Sleep Time ◀ Off ▶

3. Press the CH +/- buttons to move the indicator to "Rem ind Program", then press the VOL +/- buttons to adjust (For example, 18).

MENU	
Picture	Current Time 12: 7
Sound	Off Time 23: 00
	On Time 18: 00
Tune	On program 10
Setup	Rem ind time 19: 00
	Rem ind program 18
Timer	Sleep Time ◀ Off ▶

TIP:

The unit of the TIMER menu is minute.

Screen Display

Press CALL/HELP button to call the screen display, such as channel number, color system, sound system.

3
PAL 50
BG

Set Up Function

Select the menu Language and Screen Saver function

How to select the menu Language

- You may choose Chinese or English.

1. Press the FUNCTION button, the Function menu will appear on the screen.

2. Press the CH+/- buttons to move the indicator to "Language", then press the VOL+ button to select the desired language, then the OSD language of the TV set to the OSD language selected.

MENU	
Picture	Language ◀ English ▶
	Screen Saver ◀ On ▶
Sound	Curtain ◀ 1 ▶
	Colbrsys. ◀ PAL50 ▶
Tune	HDM scan ◀ 100Hz ▶
Setup	Transparency ◀ On ▶
Timer	Tilt ◀ 0 ▶

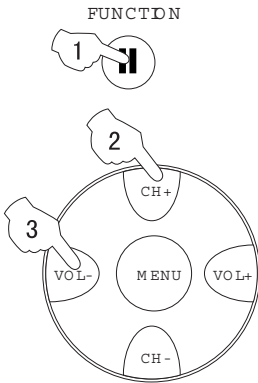

How to start screen saver function

When the SCREEN SAVER is ON, if no signal has been received, and after five minutes, it will stand by automatically.

1. Press the FUNCTION button, the Function menu will appear on the screen.

2. Press the CH+/- buttons to move the indicator to "Screen Saver".

3. Press the VOL+ button to turn the function On or Off.

MENU	
Picture	Language ◀ English ▶
	Screen Saver ◀ On ▶
Sound	Curtain ◀ 1 ▶
	Colbrsys. ◀ PAL50 ▶
Tune	HDM scan ◀ 100Hz ▶
Setup	Transparency ◀ On ▶
Timer	Tilt ◀ 0 ▶

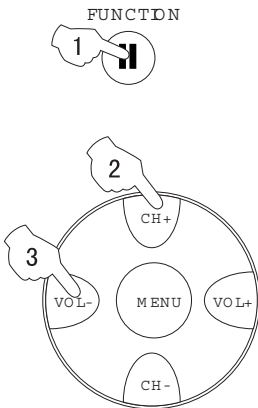

Set Up Function (Continued)

Select Switch on mode and HDM scan function

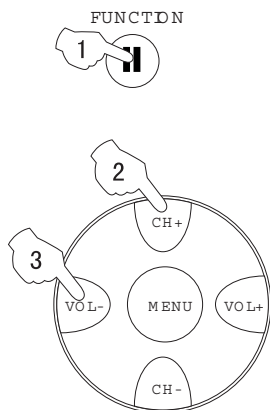

Select Switch on mode

- There are some kind of Switch on mode, such as I, II, III, etc. You can choose one you need.

1. Press the FUNCTION button, the Function menu will appear on the screen.

2. Press the CH +/- buttons to move the indicator to "Curtain".

MENU	
Picture	Language ◀ English ▶
Sound	Screen Saver ◀ On ▶
Tune	Curtain ◀ I ▶
Setup	Colorsys. ◀ PAL50 ▶
Timer	HDM scan ◀ 100Hz ▶
	Transparency ◀ On ▶
	Time ◀ 0 ▶

3. Press the VOL+ button to select the desired Switch on mode.

HDM Scan function

- The HDM scan includes Pixel, 75Hz, 100Hz and 60P, etc.

1. Press the FUNCTION button, the Function menu will appear on the screen.

2. Press the CH +/- buttons to move the indicator to "HDM scan".

MENU	
Picture	Language ◀ English ▶
Sound	Screen Saver ◀ On ▶
Tune	Curtain ◀ I ▶
Setup	Colorsys. ◀ PAL50 ▶
Timer	HDM scan ◀ 100Hz ▶
	Transparency ◀ On ▶
	Time ◀ 0 ▶

3. Press the VOL +/- buttons set the desired scan.

Set Up Function (Continued)

Tilt function and setting Transparency Menu

Tilt function

- When the TV set is affected by the geomagnetism so that the whole picture turn tilt, you can use the function.

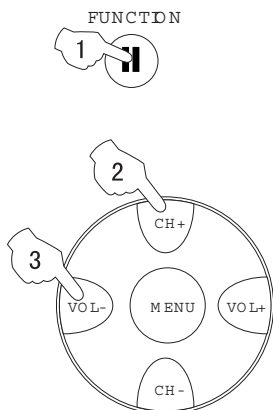

1. Press the FUNCTION button, the Function menu will appear on the screen.

MENU	
Picture	Language ◀ English ▶
	Screen Saver ◀ On ▶
Sound	Curtain ◀ I ▶
	Colorsys. ◀ PAL50 ▶
Tune	HDM scan ◀ 100Hz ▶
Setup	Transparency ◀ On ▶
Timer	Tilt ◀ 0 ▶

2. Press the CH+/- buttons to move the indicator to "Tilt".

4. Press the VOL-/+ buttons to adjust.

Setting Transparency Menu

- When the function is ON, the menu display is transparent.

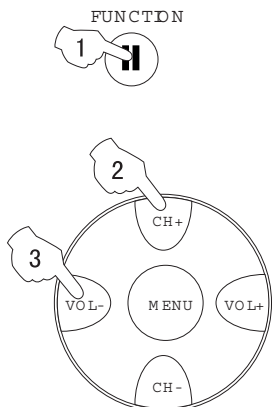

1. Press the FUNCTION button, the Function menu will appear on the screen.

MENU	
Picture	Language ◀ English ▶
	Screen Saver ◀ On ▶
Sound	Curtain ◀ I ▶
	Colorsys. ◀ PAL50 ▶
Tune	HDM scan ◀ 100Hz ▶
Setup	Transparency ◀ On ▶
Timer	Tilt ◀ 0 ▶

2. Press the CH+/- buttons to move the indicator to "Transparency".

3. Press the VOL+ button to turn the function On or Off.

Setting the Lock

- This TV set provides you with the LOCK function, you can choose it due to your need to protect your TV set.

Change your password

Change your password

This TV set can set a four digit password, the original one is 0000, if you want to reset it, please follow the instructions below.

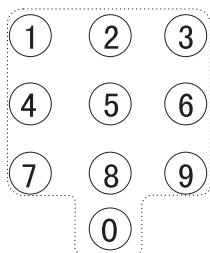
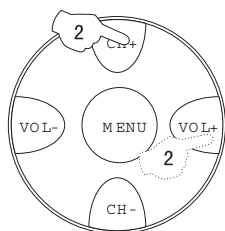

1. Press the H LOCK button, then press the Digital number button to input the password, screen will show as the form on the right.

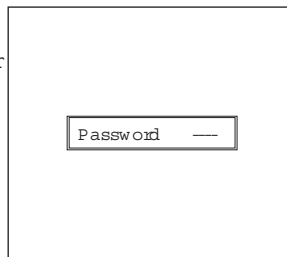

2. Press the CH +/- buttons to move the indicator to "New PWD", and then press the Digital number button to input the password.

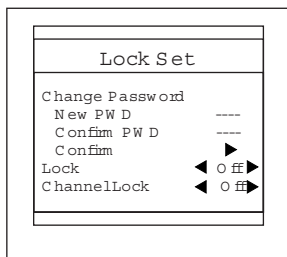

3. Press the CH +/- buttons to move the indicator to "Confirm PWD", and then press the Digital number button to input the password again.

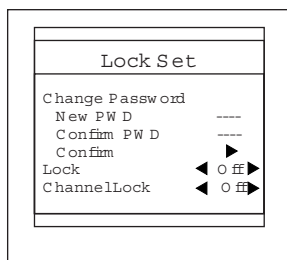

4. Press the CH +/- buttons to move the indicator to "Confirm", and then press the VOL+ to confirm. If it is correct, then the screen displays change successfully.

5. If the confirmed password is not accordance with the new password, then the screen will display failure.

Tip:

After changing the password, you must memorize the new password for fear you can not use the function.

Setting the Lock (Continued)

Setting the Lock

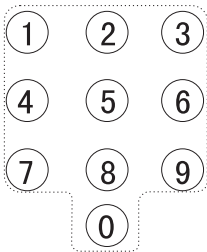
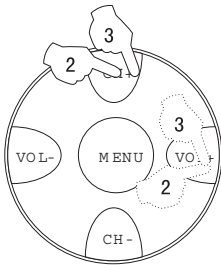
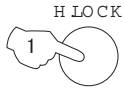

Setting the Lock

There are Child Lock and Channellock setting, you can set it due to your need.

1. Press the H LOCK button, the screen will show as the form on the right.

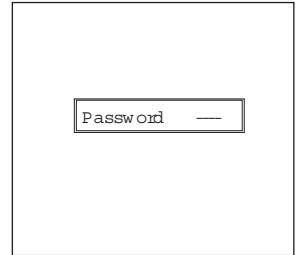

2. Press the Direct-digit Choosing button 0 for four times (or input the password you set) to enter the Lock Menu.

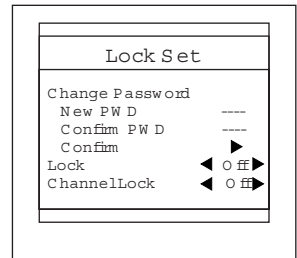

3. Press the CH +/- buttons to move the indicator to "Lock", then press the VOL+ button to turn the function ON or OFF.

Description of each lock function

1. When the LOCK is set ON, if the buttons on the TV are pressed, the screen will indicate that the TV set is in the status of Lock, and the buttons won't work.
2. The ChannelLock allows the TV to always be on the same channel when you turn it on.
3. If you forget your password or a password is accidentally set enter 9443 as the password. This will enable you to regain control.

Others Functions

Calendar, Picture Still and Zoom functions

CAL,EXIT

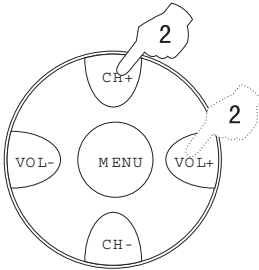

Calendar function

Note: The calendar can not renew automatically.

1. Press the CAL,EXIT button, the Calendar menu will appear on the screen.

2. Press the VOL-/+ buttons to move the indicator to the year/the month/the day, and then press the CH+/- buttons to adjust the year, the month and the day to dem and the desired date.

2000/ 1/ 1

Sun	Mon	Tue	Wed	Thu	Fri	Sat
						1
2	3	4	5	6	7	8
9	10	11	12	13	14	15
16	17	18	19	20	21	22
23	24	25	26	27	28	29
30	31					

Picture Still function

When you watching TV, press the STILL button to still the picture. Press the STILL button or any others to resume the playing.

Still

STILL



Zoom function

When you watching TV, press the ZOOM button to change the picture scale.

Zoom ◀ 4:3 ▶

ZOOM



Others Functions (Continued)

Setting and Using Favorite programs, Setting Sleep Timer

FAVORITE

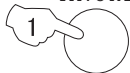

2

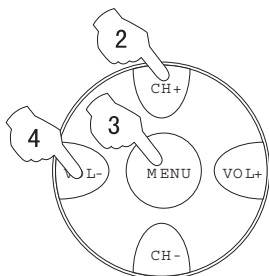

Setting Favorite programs

After setting the Favorite function, you can select the programs that you favorite.

1. Press the FAVORITE button twice, then the screen displays the Favorite menu.

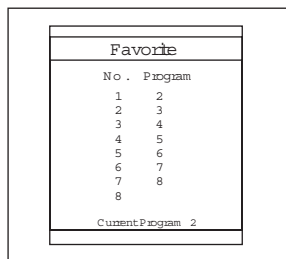

2. Press the CH +/- buttons to move the indicator to "NO. 1".

3. Press the menu button or the VOL+ button to confirm the current program. Press the VOL- button to cancel.

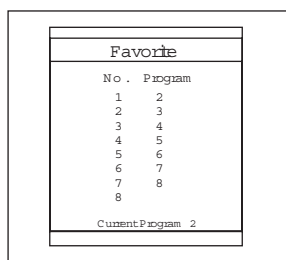

4. Repeat above steps to set other program or preset the programs.

FAVORITE



TIMER

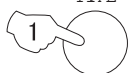

2

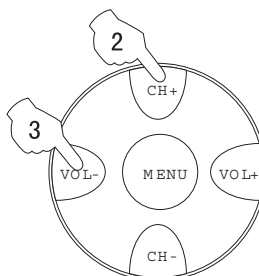

Using Favorite function

Press the FAVORITE button continuously, you can select the favorite programs that are set.

Setting Sleep Timer

1. Press the TIME button, the Time menu will appear on the screen.

2. Press the CH +/- buttons to move the indicator to "Sleep Time".

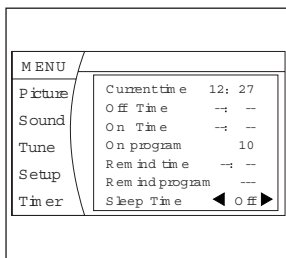

3. Press the VOL +/- buttons to turn the time on/off.

Others Functions (Continued)

VGA input adjustment

Setting the PC software

1. First, click on Settings on the Windows start menu and click on "Control Panel".
2. Double click on the Display icon.
3. Click on the Settings tab on the display dialog-box.
4. Adjust the resolution to 640X480 pixels.
5. Click the Advanced button and click the Monitor tab on the dialog-box. Set the vertical-frequency to 60Hz and then click the OK button.
6. Connect the PC to the TV set by the VGA terminal.

VGA input adjustment



1. Press the TV/AV button, then press CH +/- buttons to select the PC input mode. Press the VOL +/- buttons to confirm.

2. Press the MENU button to move the indicator to "Avan", and press VOL+ button to enter the sub-menu.

MENU		
Picture	H-Position	0
	V-Position	0
Sound	H-Range	0
	V-Range	0
Avan	PCC	0
Setup	KEY	0
	TCC	0
Timer	BCC	0

3. Press the CH +/- buttons to move the indicator to the desired options, then press the VOL +/- buttons to adjust the effect of the screen.

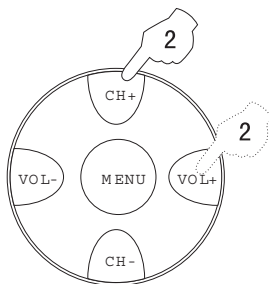

Multi-Media Player System

Multi-media player preparation

1. Supported equipment

1) Equipment supporting Mass Storage agreements include USB, mobile hard disk, card reader, some MP3 and digital camera.

2) Equipment supporting PTP agreements include some digital cameras.

2.1 Supporting media:

picture, music, MPEG 4, MPEG 2 and MPEG 1;

Supporting file formats:

*Avi, *DIVX, *MPEG, *.DAT, *MP3, *WMA, *JPG and *JPEG. Due to particularity of file code and file format, it is possible that some files may not be read.

2. If Picture & Music mode is activated, relative media file format will include JPEG and MP3 files. After Picture is selected, MP3 files set for play will open both music and picture files for sync play performance. As some files are read while music is being played, the response of picture operation response might be affected.

3. Before starting to operation, verify USB storage device is of FAT32 and FAT file system format. At present, this television does not support NTFS and the file system of other format.

4. Many movie files use suffix of AVI and MPG. However, many kinds of format are used for internal files. This television can only play some AVI and MPG files of this format. Those files with suffix of data are not movie files, expect data files used by computers, and cannot be played for movies.

5. External card readers supports most digital cards available in the market. Readable digital cards are classified according to the property of card readers and can be connected to mobile hard disks (working voltage 5.0V, working current not over 500mA).

6. Sometimes the television operation may be halted due to excessive rate of information code errors. In such case, restart the system. Because there are many non-standard USB mobile devices in the market. If this kind of USB mobile devices are used in the Multi-media play system, the problem of identification failure might occur. The same problem may also happen with computers, not televisions.

7. It is suggested that the external devices with USB 2.0 interface be used to improve velocity of information reading and continuity of information playing.

USB setup

1. Insert USB in the USB slots at the right side the TV.

2. Insert it to be clicked in.

3. Press USB button on the remote controller to enter the Multi-media system.

CARD setup

This TV is Compatible with the card of SD/MMC/CF/MS/SM format.

How to use

1. Jack of card Instructions:

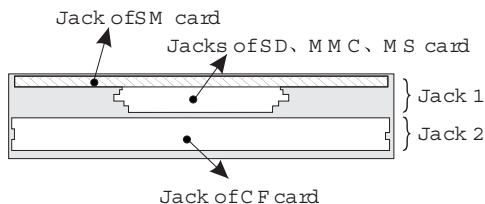

Note

1. Please note chooses uses the digital memory card with you corresponds the receptacle.

2. Card reader in 1 cannot simultaneously insert two kind of cards in the graphical representation position

Multi-Media Player System (Continued)

Multi-media player preparation

2. Insert the card as right direction .As following Card in com m on use

1) CF card:

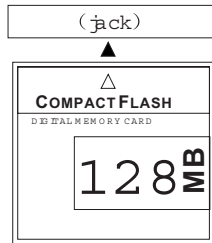

2) MMC card:



3) MS card:

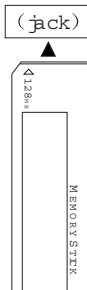

4) SM card:

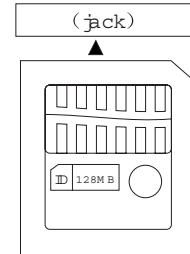

5) SD卡:

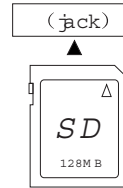

Note :

1. the card insertion time , after the flow s m edia system starts 2s , insert the card to num erical code card reader , donot bring card to start flow m edia system . 2. After card insertion , indicator light will shine , and enters glitters condition , after period of time , indicator light enters constant bright condition , indicates a ready distinguishes finished , this time carries on play operation and so on . 3. In the market , the digital card type are very many , please uses standard product of the standard factory , m eets reads takes difficult or reads speed limits , please replaces the digital card .

To start the media play

1. Press the TV/AV button on the remote control to enter the menu option. Press the CH +/- buttons to select USB , and then press VOL+ button to confirm .

2. After entering the stream media player , press ↑ ↓ buttons to select desired options .

3. Press the ← button to enter desired option .

4. Before watching TV program , you must return the main menu . Repeat the step 1 to select the TV option , and then press VOL+ button to confirm .

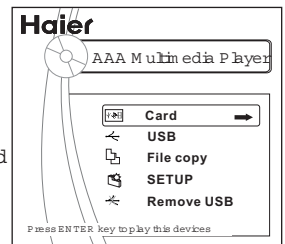

TIP : If there are no operation one minute later , the TV will enter the save automatically , at the time , press any button of USB system to exit the save menu .

TV/AV

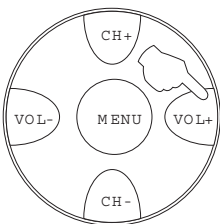
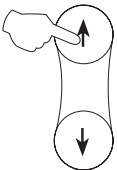

Multi-Media Player System (Continued)

To operate the m enu

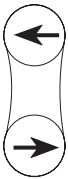
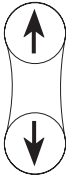

ZOOM



CALL/HELP



CAL./EXIT



To operate the m enu

1. Press the ↑ or ↓ button to select the item with up or down.

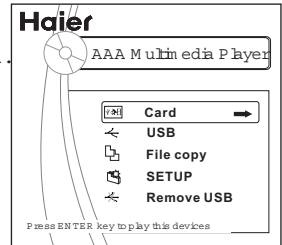

2. Press the ← or → button to select the desired item of sub-m enu with left or right.

3. Press the ↵ button to ensure the desired option, to enter the sub-m enu, to resume the speed of standard.

4. Press the ►► or ◀◀ button to operate play quickly or slowly. Press the ►► button to circum rotate the picture also.

5. Press the || button to pause the player, and press again to resume it.

6. Press the ZOOM button to enlarge the picture, and press ←/→ or ↑/↓ buttons to enjoy the detail.

7. Press the CALL/HELP button to call or exit the m enu display. And press the CALL/HELP button to call or exit the m enu display during operating file copy.

8. Press the CAL./EXIT button to return to previous m enu and stop player; press CAL./EXIT button repeatedly to return to main m enu.

Multi-Media Player System (Continued)

Multi-Media Player

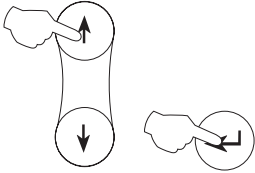

To select stream media broadcast system

1. Press the ↑ or ↓ button to select "card" or "USB". (The device be inserted and identified).
2. Press the ← button to enter selected option.

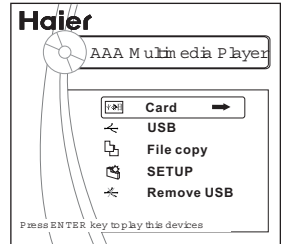

To play picture

1. Press the ↑ or ↓ button to select Picture item .
2. Press the ← button to enter the menu of play.

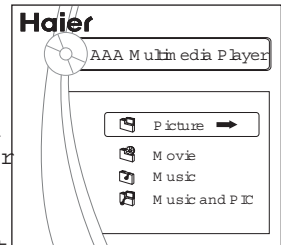

TIP :

The menu displaying is different for the files in your input devices.

3. Press the ↑ or ↓ button to select the desired picture , and then press the ← button to enter the play menu .
4. On the menu of play, press the ↑ or ↓ button to select the speed of play. (Normal, slow or fast).

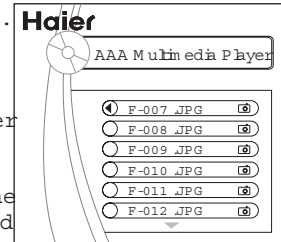

5. After disappear the menu play, press the ← or → button to swap the picture of next and previous . Press CAL./EXIT button to return.

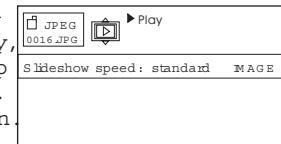

To enjoy the picture detail

1. After selecting the picture to play, press the ZOOM button to select desired scale .
2. Press the CALL/HELP button to exit the display, and then press the ↑ or ↓ , ← or → button to move and enjoy the picture detail.

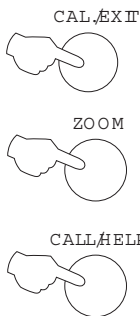

To make the picture overturn

- Press the ►► button to make overturn 90° with right once . Press the ← button to resume the program playing .

Multi-Media Player System (Continued)

Multi-Media Player

To enjoy music

1. Press the \uparrow or \downarrow button to select the Music option.

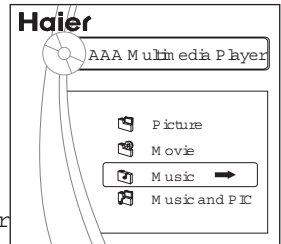
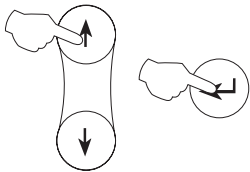

2. Press the \leftarrow button to enter the menu of play.

3. Press the \uparrow or \downarrow button to select the desired music, and then press the \leftarrow button to play.

Note: the play file menu are different with your USB device.

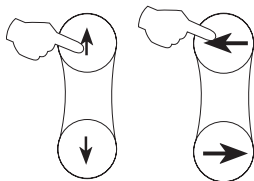
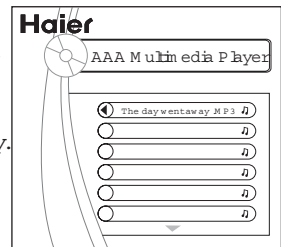

4. When playing music, press the \uparrow or \downarrow button to select play mode, (play mode: standard, program, Random, Disc Repeat, Folder Repeat, File Repeat) and press the \leftarrow button to confirm.

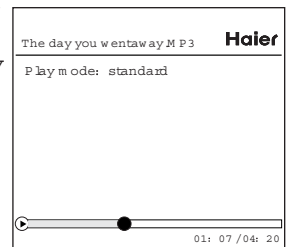

CAL./EXIT



5. Press the CAL./EXIT button to exit the playing.

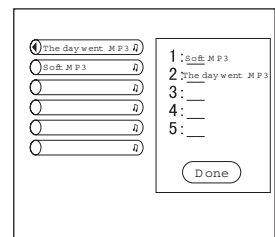

Multi-Media Player System (Continued)

Multi-Media Player

To play M ovie

1. Press the \uparrow or \downarrow button to select the M ovie option.

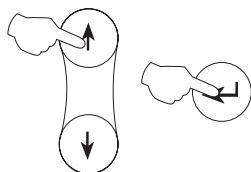
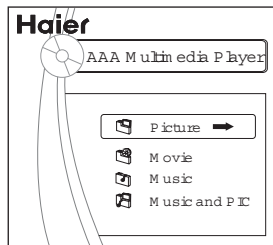

2. Press the \leftarrow button to enter the m enu of play.

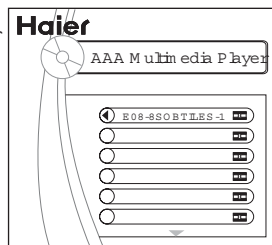

3. Press the \uparrow or \downarrow button to select the desired m ovie, and then press the \leftarrow button to play.



4. On the m enu of play, press the \leftarrow or \rightarrow button to select in turn: File-P lay Back Control-Auto channel-P lay M ode

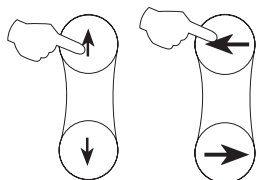

5. Press the \gg or \ll button to set speed, press \leftarrow button to resume to standard m ode.



6. Press the \leftarrow or \rightarrow button to select the next m ovie or previous.

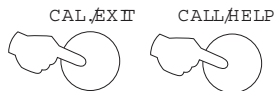

7. Press the CAL./EX IT button repeatedly to return.

Multi-Media Player System (Continued)

Multi-Media Player

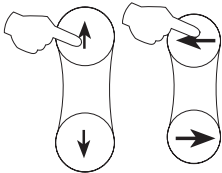
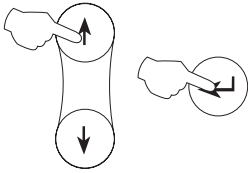

CAL./EXIT



To select the Music and PIC item

1. Press the \uparrow or \downarrow button to select the Music and PIC option.

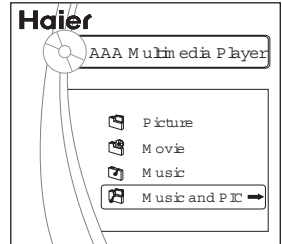

2. Press the \leftarrow button to enter the menu of play.

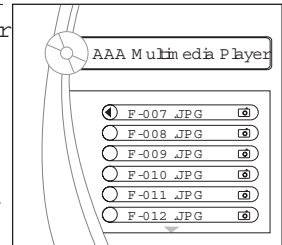

Note: the play file menu are different with your USB device.

3. Press the \uparrow or \downarrow button to select desired file, and press the \rightarrow button to confirm it. (Press the \leftarrow button to cancel). Repeat step 2 to select more files, and press the \leftarrow button to enter play menu.



TIPS :

On the playing, press the \gg or \ll button to change the pictures, press the \leftarrow or \rightarrow button to change the music.

4. On the menu of play, press the \uparrow or \downarrow button to select the speed of play. (Normal, slow or fast).

TIP :

On the playing, press the \parallel button to pause the picture.

5. Press repeatedly CAL./EXIT button to return.

Note :

On the music and picture, the playing music is *.mp3 format.

Multi-Media Player System (Continued)

Copy file function

Copy file function

1. Press the \uparrow or \downarrow button to select the File copy option.

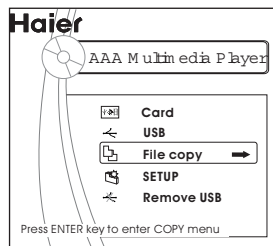
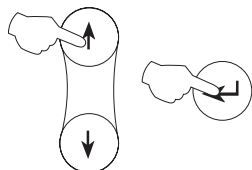

2. Press the \leftarrow button to enter the copy menu.

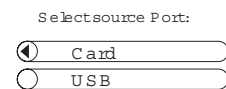

3. Press the \leftarrow button to enter the file menu, and press the \uparrow or \downarrow button to select "Card" or "USB".

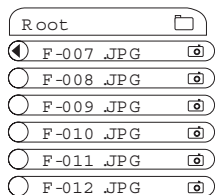

CALL/HELP



4. Press the CALL/HELP button to call the menu, and then press the \uparrow/\downarrow button to select the file, press the \leftarrow button.

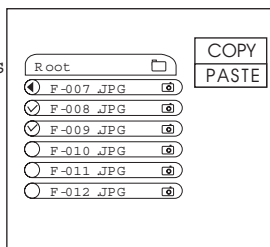

5. Press the CALL/EXIT button to exit the "Select source Port." displaying menu, and then press the \uparrow/\downarrow button to select USB or CARD.

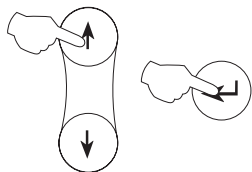

6. Press the \leftarrow button to enter the CARD or USB, to select the file folder. Press the CALL/HELP button to call the menu, and select the desired files. Press the \leftarrow button to confirm.

Multi-Media Player System (Continued)

Setup Functions

To select language

1. Press the ↑ or ↓ button to select the Setup option.

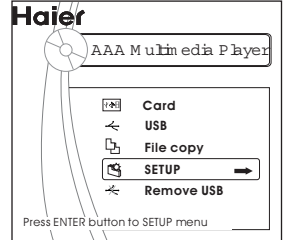
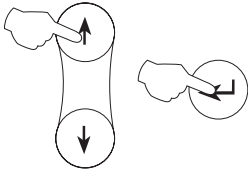

2. Press the ← button to enter the Setup menu. Press the ← button again to enter the Language option.

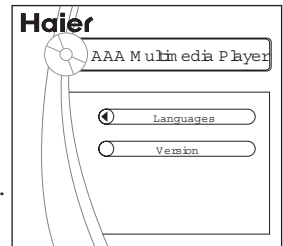

3. Press the ↑ or ↓ button to select desired language, and press the ← button to confirm.

To display the version

1. Repeat steps 1-2, and then press the ↑ or ↓ button to select version.

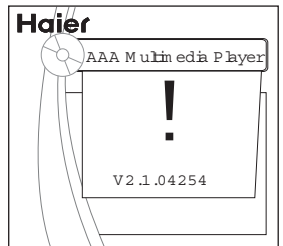
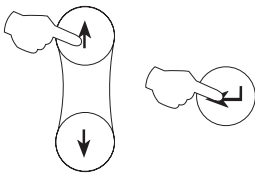

2. Press the ← button to display the version number.

Removing USB device

1. Press the ↑ or ↓ button to select the Remove USB option.

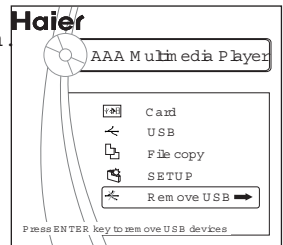
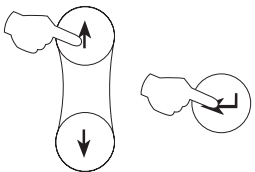

2. Press the ← button to confirm.

3. Remove the memory card/USB device.

4. If to remove the card device, press the CAL./EXIT button to return to the main menu, and remove the card.

External connections

- In the following, the methods of connecting the video/audio system and PC for the TV set will be explained.

Video/Audio Output Connection, VGA Input

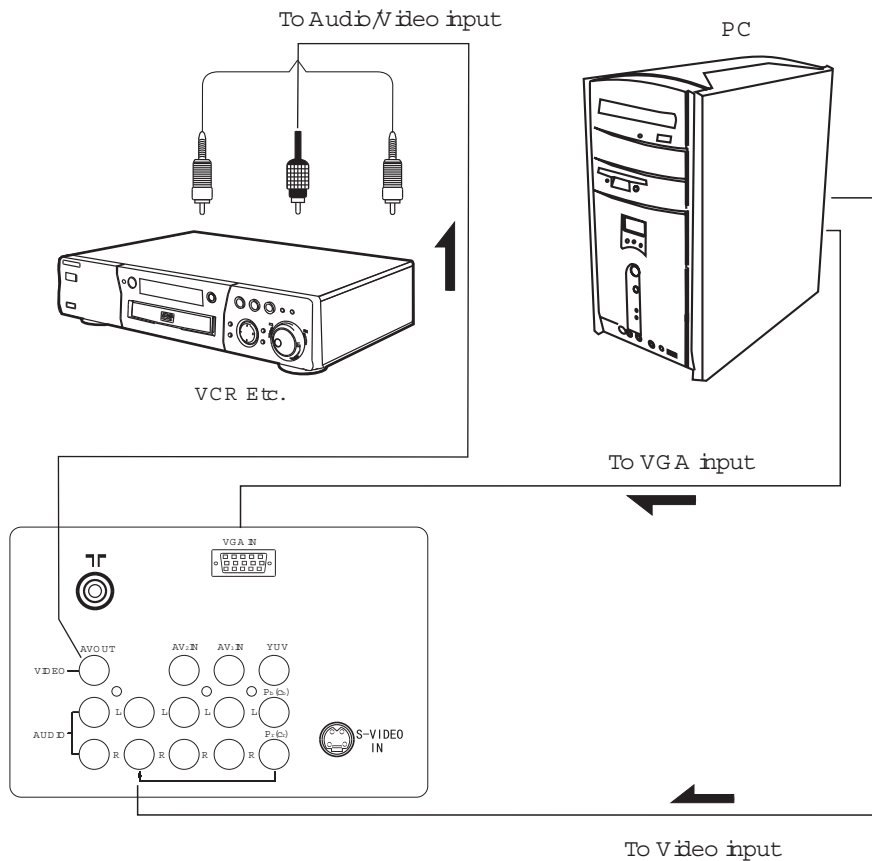

External connections (Continued)





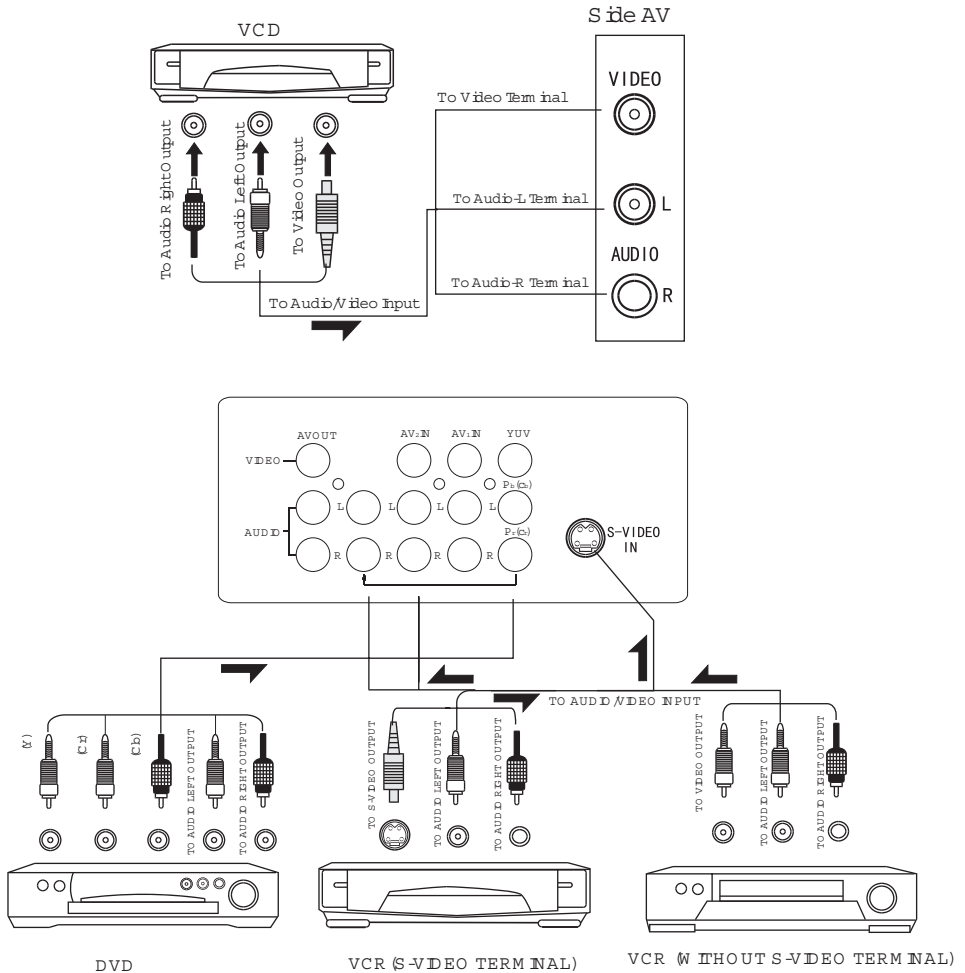











- In the following, the methods of connecting the video/audio system and others sets for the TV set will be explained.

Video/Audio Input Connection



Trouble shooting

- To assist in location possible faults use help guide below.

BREAKDOWN PHENOMENON		CHECKING
PICTURE	SOUND	
 Picture with snow	 Noise	The aerial direction and connection
 Double or Triple Image	 Normal	This is called ghosting which can be minimized with an outside aerial, and good quality cable and terminations. Altering the aerial direction can also minimize this effect.
 Disturb	 Noise	Electrical interference which can be caused by cars, motorbikes etc, Fluorescent lamps and dirty insulators on overhead power cables.
 Normal	 No sound	Volume Sound mute
 No Picture	 No sound	Ensure that the power supply is connected to the TV set and tuned on. Also ensure that the brightness and contrast are not turned down.
 No colour	 Normal volume	Adjust colour control
 Scramble	 Normal or Weak Volume	Adjust channel again
 Colour Spot	 Normal volume	Colour Purity fault which can be caused by moving the TV set, placing magnets near the TV screen or turning on/off household appliances such as vacuum cleaners near the TV set. Turn the TV off with the mains power switch for 15 minutes. When the power is turned on again the TV set will automatically degauss the picture. In severe cases leave the TV set turned off overnight.

Note:

- If the fault can not be repaired using the above guide consult with your local authorized service center.
- The cabinet may produce the occasional "snapping sound" This is normal and caused by the materials in the cabinet expanding with room temperature changes.

Specifications

- Design and specifications are subject to change without notice.

[The different specifications of different models]

Model	Dimensions (mm)	Power consumption
29F5D	817 (W) x 616 (H) x 515 (D)	≤ 200W
34F5D	920 (W) x 695 (H) x 530 (D)	≤ 220W

[The same specifications of different models]

Cobrsystem	PAL, SECAM, AV NTSC 3.58, 4.43	
Sound system	B/G, D/K, M	
Sound output	8W + 8W & 10W	
Power supply	~160V-250V, 50Hz/60Hz	
Accessories	Remote control	X1
	Owner's manual	X1
	Battery (AA)	X2
	Circuit diagram	X1

Haier

Free Manuals Download Website

<http://myh66.com>

<http://usermanuals.us>

<http://www.somanuals.com>

<http://www.4manuals.cc>

<http://www.manual-lib.com>

<http://www.404manual.com>

<http://www.luxmanual.com>

<http://aubethermostatmanual.com>

Golf course search by state

<http://golfingnear.com>

Email search by domain

<http://emailbydomain.com>

Auto manuals search

<http://auto.somanuals.com>

TV manuals search

<http://tv.somanuals.com>