

COLOUR TV RECEIVER

OWNER'S MANUAL

Please read this manual carefully before operating the unit, and keep it for future reference.

The Owner's Manual for the Follow Model:
29FA10-AM

CONTENTS

Before Operation

Warning and Cautions	2
Installation.....	3
Antenna connection.....	3
Preparation for the remote control	3
Position of keys and plug-ins	4
Front and side panel.....	4
Back panel.....	4
Using the remote control.....	5

Basic Operation

Power on and power off	6
Viewing TV programs.....	7
Viewing TV programs.....	7
Program scan and screen display.....	8
Saving mode, favorite program and shuttle.....	9
FM.....	10
Tuning.....	11
Automatic search.	11
Manual search	12
MFT.....	13
Skip.....	14
Adjusting the picture and the sound.....	15
Multiple picture modes	15
Multiple sound modes and setting the sound.....	16
S.C.C auto off and mute.....	17
Setting the other function.....	18
3A filter and screen protection.	18
Timer off.	19
Sleep timer and on timer	20
Setting the timer.....	20
Channels appointment.....	21
Background.....	22
Curtain function, calendar display	23
Channel exchange.....	24
Setting the lock.....	25
Changing your password.....	25
Setting the lock.....	26
Game.....	27
Game control buttons and method of playing the game.....	27

Technical operation

Connecting Additional Equipments.....	28
---------------------------------------	----

Others

Troubleshooting	29
Specifications.....	30

Warning and Cautions

1. When you clean the TV set, please pull out the power plug from AC outlet. Don't clean the cabinet and the screen with benzene, petrol and other chemicals.



4. To prevent the TV set from firing and electric shock, don't expose the TV set to rain or moisture.

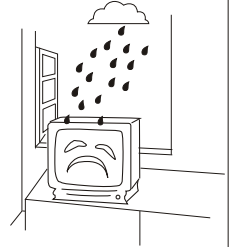

2. In order to prolong the using life of the TV set, please place it on a ventilated place.

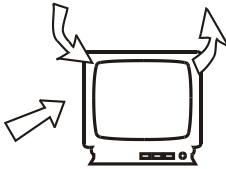

5. Don't open the back cover, otherwise it is possible to damage the components in the TV set and harm you.

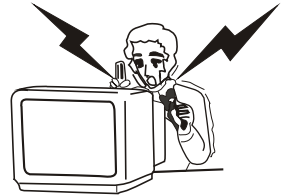

3. Don't place the TV set in the sunshine or near heat source.

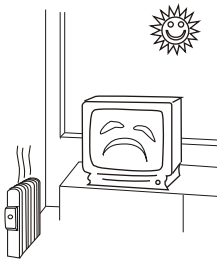

6. When the TV set isn't going to be used for long time or it is in thunder and lightning, please pull out the plug from AC outlet and the antenna plug from the cover of the TV set.

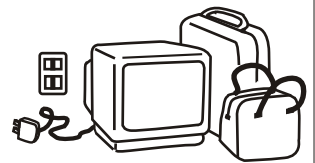

Explanation on the display tube

In general, it is not needed to clean the tube surface. However, necessary, it's surface can be cleaned with a dry cotton cloth after cutting off the power. Don't use any cleanser. If using hard cloth, the tube surface will be damaged.

Installation

Antenna connection

Generally speaking, to enjoy a clearer picture, we recommend that you use a CATV system or an outdoor antenna. In different places, the suitable antenna type and position are different.

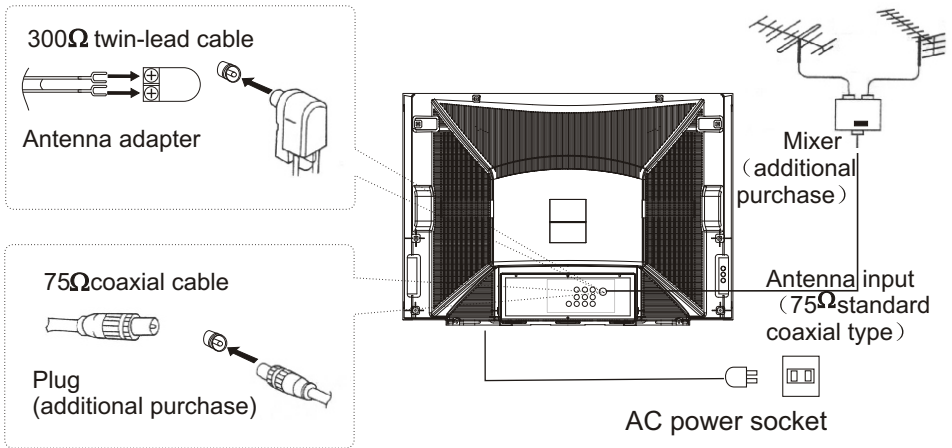

Note:

- * It is recommended that you'd better use 75Ω coaxial cable to remove the disturbance caused by airwave.
- * Don't bind antenna cable and electric wire together.

Preparation for the remote control

Battery installation

Remove the batteries cover.

Insert two size AA batteries matching the +/- polarities of the battery to the +/- marks inside the battery compartment.

Tips for remote operation

The battery life should be about one year under normal use.

When the remote control will not be used for a long period of time or when the batteries are worn out, remove the batteries to prevent leakage.

Do not throw the batteries into a fire. Dispose of used batteries in the specified manner.

Do not drop, dampen or disassemble the remote control.

Position of Keys and Plug-ins

Front panel

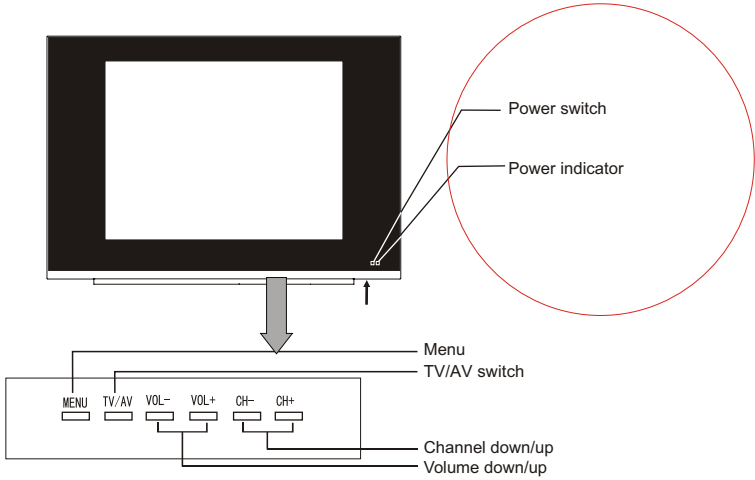

Back and side panel

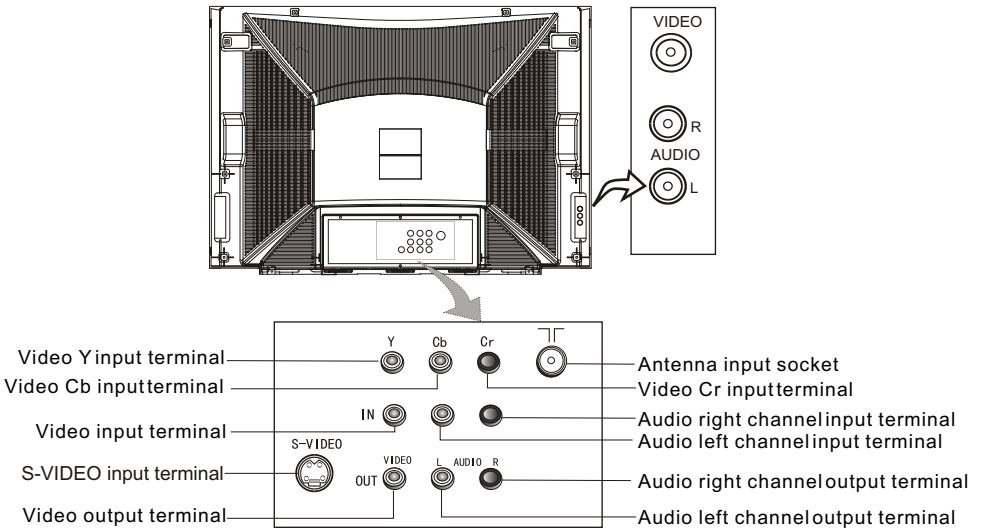

Using the Remote Control

Buttons and Descriptions

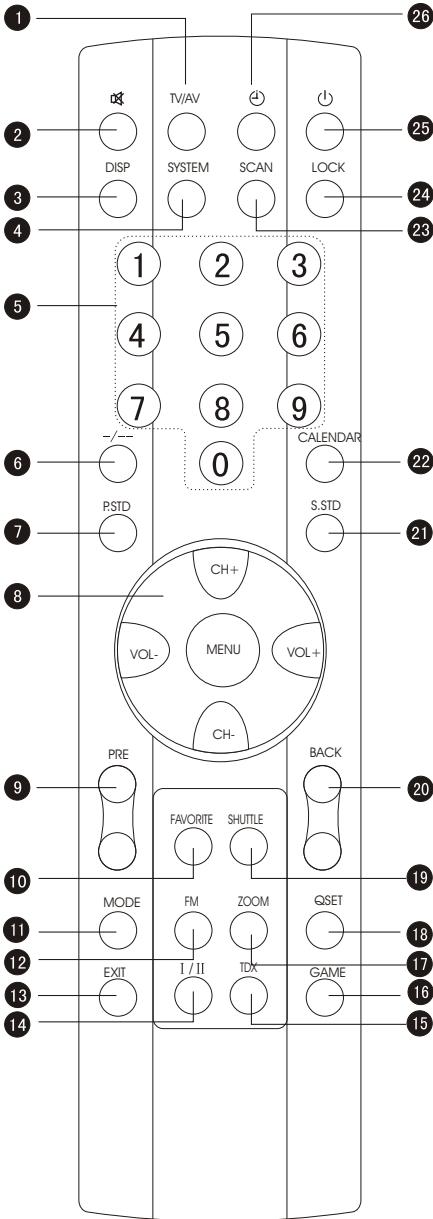

- 1 TV and AV Exchange Button
To exchange between TV and other available video inputs
- 2 Mute Button
Press to conceal the sound of programs.
- 3 Screen Display Button
- 4 System Adjust Button
- 5 Direct-digit Choosing Button
Directly select channel numbers
- 6 Digit Select Button
Change the channel position number between one digit, two-digits and three-digits.
- 7 Picture Mode Select Button
There are DYNAMIC, STANDARD, MILD, MEMORY, PICTURE MUTE and COLOR MUTE six modes of picture.
- 8 Menu Select/Adjust Button
Use this button to adjust the menu, the volume and the channels, as well as to control the game.
- 9 Program Play-forward Button
- 10 Favorite program button
- 11 Game Background Select Button
- 12 FM on /off button
- 13 Game Exit Button
- 14 No available
- 15 No available
- 16 Start/Restart Game Button
- 17 Change the aspect ratio
- 18 Saving mode on/off button
- 19 Shuttle button
- 20 Program Play-backward Button
- 21 Sound Mode Select Button
- 22 Calendar
- 23 Program Scan Button
- 24 Lock Setting button
- 25 DC Standby Button
- 26 Sleep Timer Button

Power On and Power Off

- Below are methods on how to power on/off the TV set with the switch on the TV and on the remote control.

Power on/off

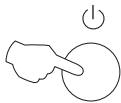
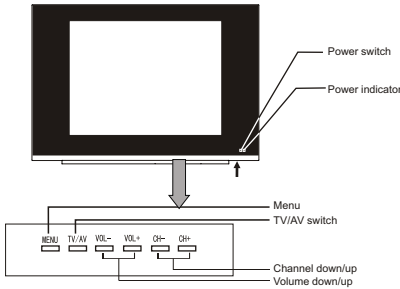

DC Standby Button

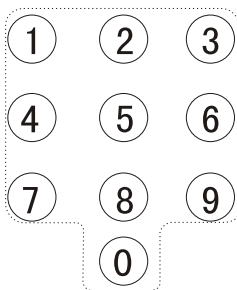

Direct-digit Choosing Button

Connect/disconnect to the power

1. Connect the power supply wire, then press power switch button, the power indicator will light, in several seconds the picture will appear on the screen.

2. If the TV is in the state of standby, press the  button on the remote control.

NOTE

- You can also press the 0-9 button to call off the standby status instead of pressing the DC Standby button. Press the digit button of the preset channel (limited to one digit), you can complete the selection of channel while you turn on the TV set(To operate the preset of TV channel, please see TUNING on page 11-14).
- When you do not use the remote control, you can directly press the CH+/- button on the television to call off the standby status.



3. Press the  button on the remote control to get into the standby status.

4. Press the  button on the TV set to completely turn off the TV.

Viewing TV Programs

- The channels amount to 218 .

Viewing TV programs

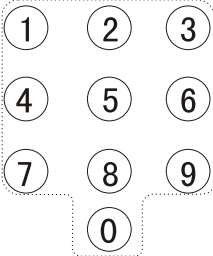

Direct-digit Choosing button



PRE BACK

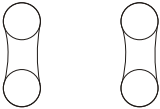

SYSTEM

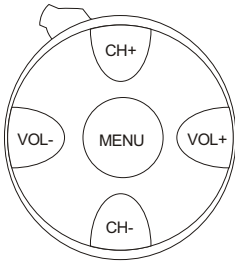

How to select the TV program

1. Use the direct-digit choosing button
 - Press the button from 0-9 to select a one digit channel.
 - If you want to select a two-digits channel, press the Digit Select button and change it into two-digits mode, then press the number of the channel.
 - If you want to select a three-digits channel, press the Digit Select button and change it into three-digits mode, then press the number of the channel.
 - If the channel position number you select is larger than 218, the TV will use the first two number as the channel position.
2. Use CH+/- button
 - Press CH+ to increase the channel position number.
 - Press CH- to decrease the channel position number.
3. Use PRE button and BACK button
 - Press PRE button, you can go back to the channels you viewed (as many as four).
 - Then, press BACK button, you can return to the channels you were watching just now (as many as four) .
 - For example, if you have viewed channel 1,2,3,4,5,6 after the TV is powered on, and the channel you are watching now is number 7, then press PRE button, you can view channel 6,5,4,3, and you may press the Back button to return to channel 7.

Choose the proper volume you like

Press VOL+/- button to adjust the volume.

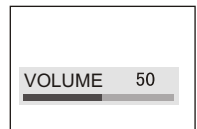

If the color of one channel is abnormal

It might be because the color has been set improperly. You may follow the instruction below to adjust it. Press SYSTEM button, and you can see the figure.

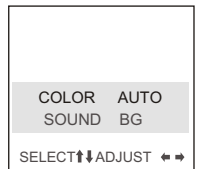

- If the color of the picture is abnormal Press CH+/- button, and move the indicator to COLOR, and press VOL+/- button to select the proper color(AUTO, NTSC3.58,NTSC4.43 and PAL will appear alternately). Generally, please set to AUTO.
- If the sound is abnormal Press CH+/- button, and move the indicator to SOUND, and press VOL+/- button to select the proper sound.

Viewing TV Programs (continued)

- Program scanning function is to let the television automatically scan all preconcerted channel program (about two seconds per channel).

Program scan and screen display

Program scanning function



1. If you want to scan the programs and select your favorite channel, just press the SCAN button, then the television will start scanning from the present channel with a rate of two seconds per channel and until all the preconcerted programs have been displayed once, the TV set will return to the starting channel.

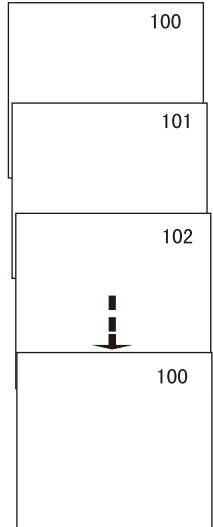

2. If you want to terminate this function during the scanning, press the SCAN button again, and the program will stay at the present channel.

Screen display



Usually, when you press the DISP button, the channel number will appear on the top right corner of the screen and press it again, the channel number will disappear or disappear automatically in about 5 seconds.

Viewing TV Programs (continued)

Saving mode, favorite program and shuttle

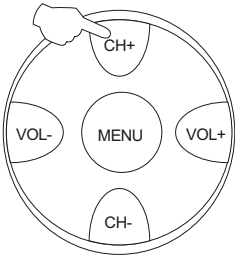

QSET



FAVORITE



SHUTTLE



Saving mode

1. Using the QSET button

- Press the QSET button to switch the saving mode on/off. And the screen will display on/off at the same time.
- Press the QSET button more than 3 seconds to call the ENERGY SAVE menu .

- #### 2. Press VOL+/- button and CH+/- button to set the options of AMBI-LUM/ AMBI-SND, after this, select the ADJUST option and press VOL+/- button to display OK, the set is finished.

ENERGY SAVE	
AMBI-LUM	BRI.
AMBI-SND	NOISE
ADJUST	➔
SELECT	↑↓
ADJUST	←➔

Note: 1. After adjusting the item in the ENERGY SAVE, the energy save function is on automatically.

2. If the energy save mode is on, the buttons P.STD and S.STD will not work. The screen displays ENERGY SAVE ON.

Favorite program setting

Press FAVORITE button for long time to enter the menu as right figure. Press CH+/- button to select the favorite program and VOL+/- button to adjust the channel. You could set 8 favorite programs.

After the setting, press FAVORITE button to select your favorite channel you have set .

FAV/POS	
1	2
2	3
3	4
4	5
5	6
6	7
7	8
8	9

Shuttle

Press SHUTTLE for long time to set the program you are watching as the shuttle channel.

If you want to back to this channel from the current channel, press SHUTTLE button once .

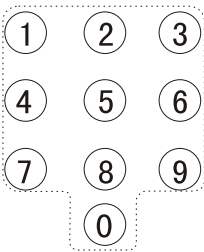
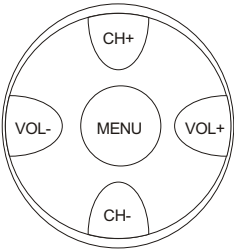

FM

Press FM to enter and press again to exit

Press CH+/- button to tune automatically

Press VOL+/- button to tune manually, press VOL+/- button to adjust the volume if there is no FM on screen.

1、 Press FM to enter.

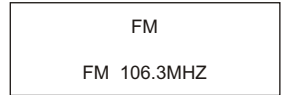

2、 Press CH+/- button to start to tune automatically.



3、 After searching the program the screen displays as right figure, you could press 0 button according the menu and displays as right.

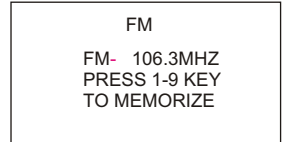

4、 Press 1-9 to display the menu. That means the programs have been stored.(take 1 for example)

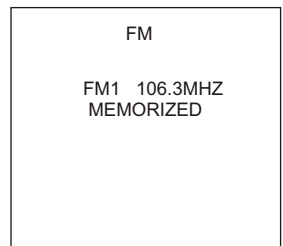

Note:1. Press VOL+/- button to tune manually.
Other steps is the same as the auto tuning.
2. 9 channels could be stored.

Tuning

- There are three ways of searching: automatic search, manual search and MFT (manual fine tune).
- You may operate it either on the TV or on the remote control. Here is mainly about the remote control.

Automatic search

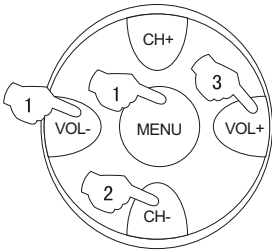

Automatic search

1. Press MENU button continuously until select TUN menu.

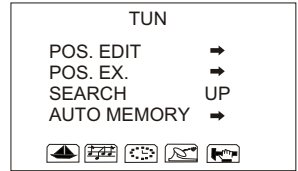

2. Press CH+/- button to move the indicator to AUTO MEMORY.

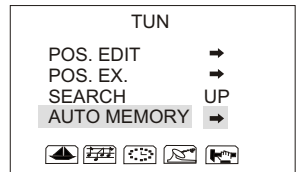

3. Press VOL+ button, then AUTO MEMORY mode will work. The TV set will search automatically all available programs, after that, all available programs will be stored in turn and the TV set will return to the first channel.

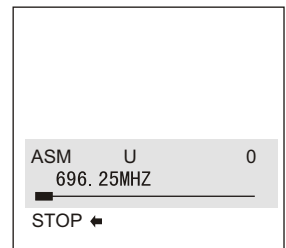

- If you want to stop the search, just press VOL- button.
- The order of the automatic search is due to the frequency of the program, generally speaking, it is used only at the first time you search the program, and once the order of the program has been confirmed, you don't have to use this function, otherwise the order of the program will be changed.

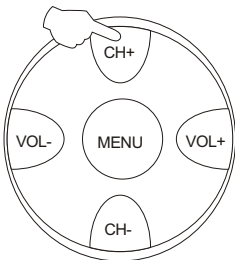

After searching

- Press CH+/- button to check the channels.
- If the color is abnormal in a certain channel, it may be the color system has not been set properly, so you should adjust it to the proper system (Reference to page 7).

Tuning(continued)

Manual search

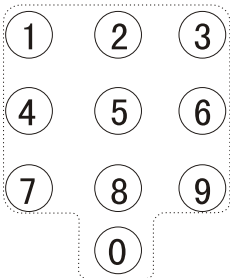
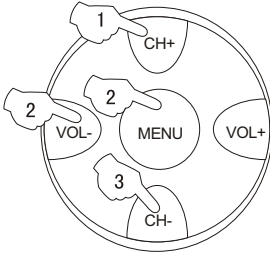

Direct-digit Choosing Button

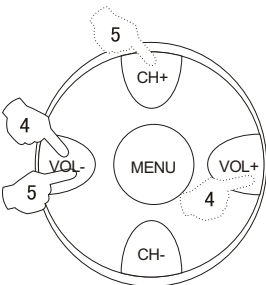

Manual search

1. Press CH+/- button or the Direct-digit Choosing button to select a channel directly (take channel 1 for example).

2. Press MENU button continuously until select TUN menu.

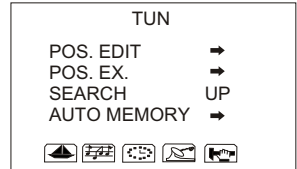

3. Press CH+/- button and move the indicator to SEARCH.

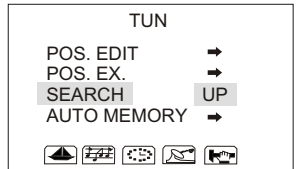

4. Press VOL+/- button to start searching.

- VOL- button is used to search the lower frequency channel.
- VOL+ button is used to search the higher frequency channel. Repeat the steps until you find the channel you need.

Tuning(continued)

MFT

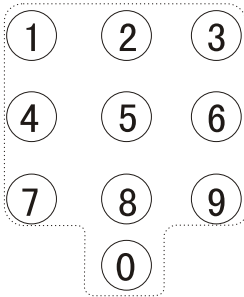
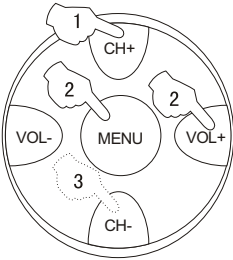

Direct-digit Choosing Button

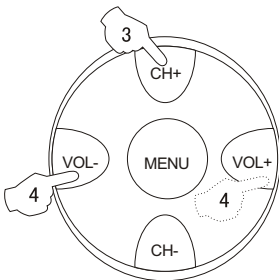

MFT(manual fine tune)

When you can't get a satisfactory picture and audio effect, you can fine tune to obtain.

1. Press MENU button continuously until select TUN menu.

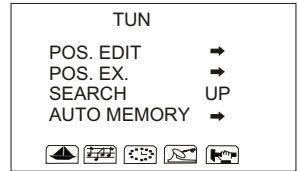

2. Press CH+/- button to select POS. EDIT and VOL+ button to enter.

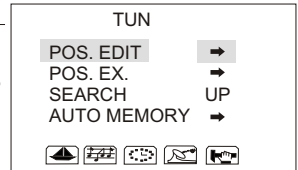

3. Press CH+/- button to select POSITION and VOL+/- button to select the channel (Take channel 1 for example)

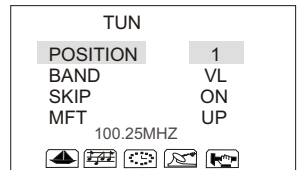

Note: the same way to adjust the BAND, and VL/VH/U will appear alternatively.

4. Press CH+/- button and move the indicator to MFT.

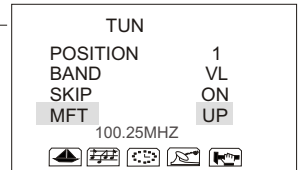

5. Press VOL+/- button repeatedly to fine tune, until the picture and the sound become satisfactory.

- VOL- button is used to search the lower frequency channel.
- VOL+ button is used to search the higher frequency channel.

Tuning(continued)

Skip

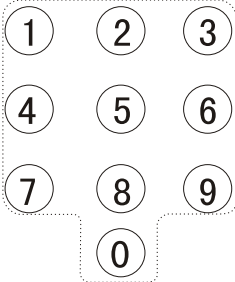

Direct-digit Choosing Button

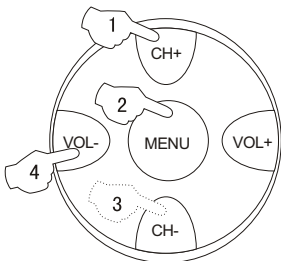

Skip

After the programs are presetted, you can skip some programs so that to select your favorite channels only.

1. Press MENU button continuously until select TUN menu.

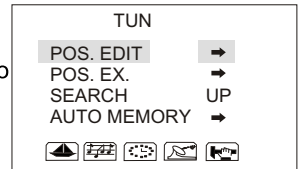

2. Press CH+/- button to select POSITION and VOL+/- button to enter.

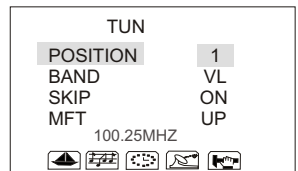

3. Press CH+/- button to select POSITION and VOL+/- button to select the channel (Take channel 1 for example)

4. Press CH+/- button and move the indicator to SKIP.

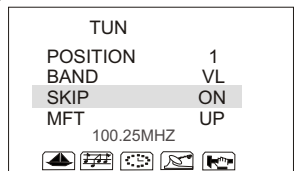

5. Press VOL+/- button to set it ON.

6. Press DISP button to close the menu. When you select channels with CH+/- button, this channel will be skipped. However, you can also use the Direct-digit Choosing button on the remote control to select this channel directly.

If you want to recover the skipped channel

1. Use Direct-digit Choosing button to select the number of the channel to be recovered.
2. Do the above steps again.
3. Press VOL+/- button to set SKIP OFF.

Adjusting the Picture and the Sound

Multiple picture modes

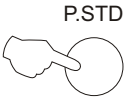

How to select the picture mode

You may select the mode you want from the five preset modes and one individual mode.

Press the P. STD button to select a mode you like. DYNAMIC PICTURE, STANDARD PICTURE, MILD PICTURE, MEMORY, PICTURE MUTE and COLOR MUTE, totally six picture modes can be selected alternately.

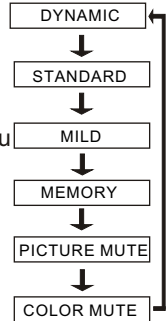

MODE	PICTURE QUALITY
DYNAMIC	BRIGHT COLOR
STANDARD	MEDIUM COLOR AND BRIGHTNESS
MILD	LOW COLOR AND BRIGHTNESS
MEMORY	SET BY YOURSELF
PICTURE MUTE	NO PICTURES
COLOR MUTE	BLACK AND WHITE PICTURE

If the picture mode is set to PICTURE MUTE or COLOR MUTE, it will autorenew to DYNAMIC mode when you restart your TV set with remote control.

Set the parameter of MEMORY

1. Press MENU button continuously until select PIC menu, press CH+/- button to select ADJUST and VOL+/- button to enter.

2. Press CH+/- button, move the indicator to the option you want to adjust, then press VOL+/- button to do the adjustment. Then the parameter will be automatically stored in MEMORY option.

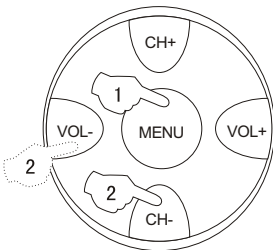
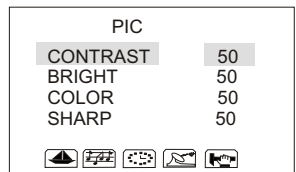
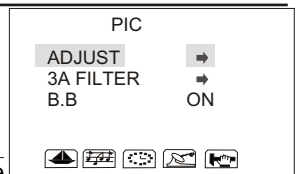

OPTION	VOL+	VOL-
CONTRAST	STRONG	WEAK
BRIGHT	BRIGHT	DARK
COLOR	THICK	LIGHT
SHARP	SHARP	SOFT
TINT	PURPLE	GREEN

*The item of TINT appears when the N system signal is received, and you can adjust it by VOL+/- button.

Adjusting the Picture and the Sound

(continued)

Multiple Sound Modes and Setting the Sound

S.STD



How to select the sound mode

You can quickly select your most favored sound mode from the following four kinds of modes.

Press the S.STD button to select the sound quality that you want. THEATER/NEWS/STD./USER can be selected in turn (their parameter may be adjusted due to your need).

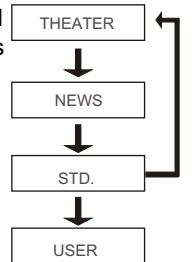

Setting the sound

This function can let you regulate the volume to the preconcerted parameter quickly (such as the BASS/TREB/BALANCE/S.WOOFER/WOOFER).

1. Press MENU button continuously until select SND menu.

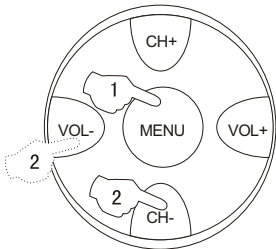

2. Press CH+/- button, move the indicator to the BASS, then press VOL+/- button to adjust the parameter you expect. With the same method, you can adjust the parameter of the BASS/TREB/BALANCE/WOOFER.

SND				
BASS	20			
TREB	40			
BALANCE	±00			
S.WOOFER	OFF			
WOOFER	00			

S.STD



3. Press the S.STD button repeatedly to select the different sound setting modes.

Adjusting the Picture and the Sound

(continued)

S.C.C, auto off and mute

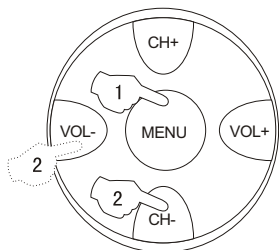

How to use the S.C.C(soft change channel)

- This TV set provides you with the function of S.C. C. When it is set "ON", the picture will fade in and fade out when the channel is changed.

1. Press MENU button continuously until select FUN menu.



2. Press CH+/-button, move the indicator to the S.C.C, then press VOL+/-button to set it ON or OFF.

Auto off

To prevent from forgetting to turn off the TV, this TV could turn off automatically. That is , if the off timer is set on and after two hours without any operation, this TV will switch into standby mode automatically to save your energy.

1. Press MENU button continuously until select FUN menu.

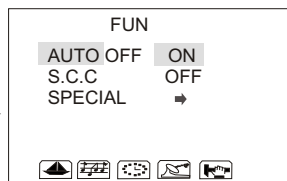

2. Press CH+/-button, move the indicator to the AUTO, then press VOL+/-button to set it ON.

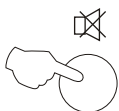

How to use the MUTE function

When you want to pay attention to the environment or answer a telephone, or to meet guests, using the mute function is very convenient.

1. Press  button, a sign will appear at the bottom center of the screen, and the sound of the TV set is cutoff.



2. In order to recover the sound, press  button again or press VOL+/-button.

Setting the other Function

3A filter and screen protection

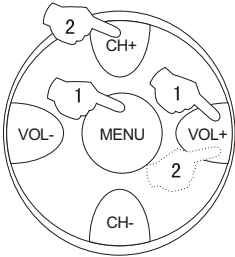

How to use the 3A filter function

1. Press MENU button continuously until select the PIC menu. Then press CH+/- button to move the indicator to 3A FILTER, and press VOL+/- button to enter.

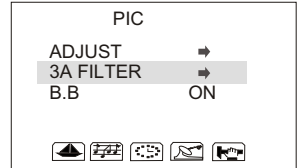

2. Press CH+/- button to move the indicator to the item you want to adjust and then VOL+/- button to adjust it . (Only available for USER mode)

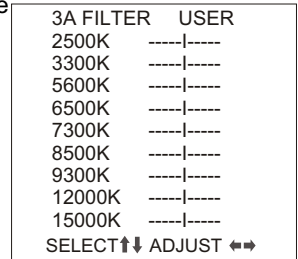

Note: FILTER can switch USER, STANDARD, 6500K, 7300K, 8500K and 9300K in cycle, and the color temperature changes when you switch.

Setting the Timer

- This TV set provides you with three timer functions such as timer on, timer off and sleep off.

Timer off

Timer off

Using this function can turn the TV set automatically into standby status at the preconcerted time.

1. Press MENU button continuously until select TIM menu, press CH+/- button to select CLOCK and VOL+/- button to set the time. (it will be the standard of the clock of ON/OFF TIMER.)

TIM	
CLOCK	0:00
OFF TIMER	0:00
ON TIMER	OFF
ON POS	0
APP. TIME	OFF
APP. POS	0



2. Press CH+/- button, move the indicator to OFF TIMER, then press VOL+/- button to set the time.

TIM	
CLOCK	0:00
OFF TIMER	0:00
ON TIMER	OFF
ON POS	0
APP. TIME	OFF
APP. POS	0



- Repeatedly press VOL+/- button, the time changes with a rate of one minute;
- Press VOL+/- button without releasing, the time changes with a rate of ten minutes.

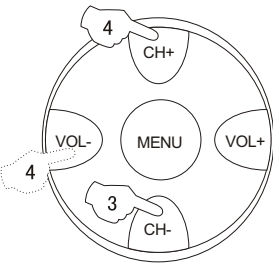
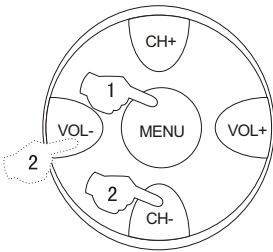

Setting the Timer (continued)

Sleep timer and on timer

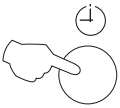

Sleep timer

Using this function, the TV set can be changed into the standby status after a period of preset time from when this function is activated.

1. The utmost time for this function is 120 minutes, and the time interval is 10 minutes. There are totally 12 kinds of off-time.

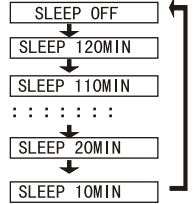

2. Press the button repeatedly, the screen will show in turn as the right form.

On Timer

When this function is used, the TV set can automatically turn the power on at the preset time in the standby status and display the preset program.

1. Press MENU button continuously until select TIM menu.

TIM	
CLOCK	18:00
OFF TIMER	18:20
ON TIMER	OFF
ON POS	0
APP. TIME	OFF
APP. POS	0

2. Press CH+/- button to select CLOCK and VOL+/- button to set the time. (it will be the standard of the clock of ON/OFF TIMER.)

TIM	
CLOCK	18:00
OFF TIMER	18:20
ON TIMER	19:00
ON POS	0
APP. TIME	OFF
APP. POS	0

3. Press CH+/- button, move the indicator to ON TIMER. Then, press VOL+/- button to set the time. (The method is the same as OFF TIMER.)

TIMER	
CLOCK	18:00
OFF TIMER	18:20
ON TIMER	19:00
ON POS	1
APP. TIME	OFF
APP. POS	0

4. Press CH+/- button, move the indicator to ON POS, press VOL+/- button to set the channel with which the TV is turned on (take 1 for example).

Note: if you set the APP.POS in child lock, APP.POS will be the standard of ON POS.

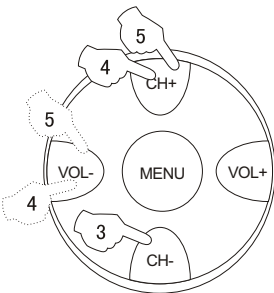
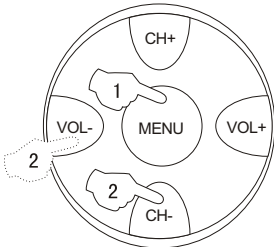

Setting the Timer (continued)

- The channels appointment function can help you conveniently preset programs. At the preset time, the TV set will automatically change to the preconcerted channel. If two or more programs are set in a same time, the last channel number will be selected.

Channels appointment

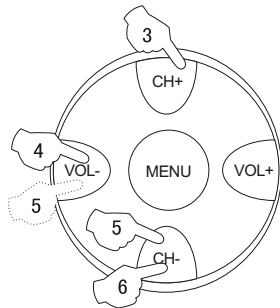
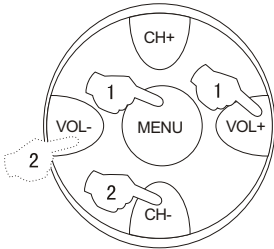

DISP



Channels appointment

1. Press MENU button continuously until select TIM menu, press CH+/- button to select CLOCK and VOL+/- button to set the time. (The method is the same as OFF TIMER. It is the standard of the clock of APP. POS)

TIM	
CLOCK	18:00
OFF TIMER	18:20
ON TIMER	19:00
ON POS	1
APP. TIME	OFF
APP. POS	0

2. Press CH+/- button, move the indicator to APP.TIME. Then press VOL+/- button to set the time (the method is the same as OFF TIMER).

- Repeatedly press VOL+/- button, the time changes with a rate of one minute;
- Press the button without releasing, the time changes with a rate of ten minutes.

TIM	
CLOCK	18:00
OFF TIMER	18:20
ON TIMER	19:00
ON POS	1
APP. TIME	19:30
APP. POS	0

3. Press CH+/- button, move the indicator to APP.POS.

4. Press VOL+/- button to set the channel number you want (e.g. 100).

TIMER	
CLOCK	18:00
OFF TIMER	18:20
ON TIMER	19:00
ON POS	1
APP. TIME	19:30
APP. POS	100

- At the preset time, the TV set will automatically change to the preconcerted channel;
- This function is only available when the TV set is on, and it cannot be used in the status of standby or power off.

Setting the Function

Background

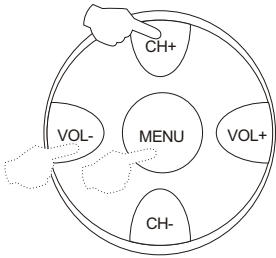

Background selection

If no signal has been received by the TV set, when the B.B function is set ON, the screen will change into the form on the right shows.

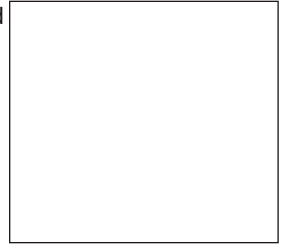

Press MENU button continuously until select the PIC menu. Then press CH+/- button to move the indicator to B.B, and press VOL+/- button to set it ON.

PIC	
ADJUST	→
3A FILTER	→
B.B	ON

SELECT ↑↓ ADJUST ↔

Setting the other Function(continued)

Curtain function,calendar display

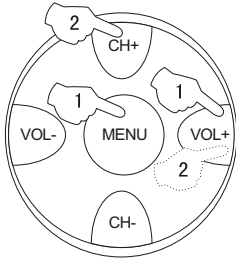

How to use the Curtain function

- This TV set provides three types of Curtain function for you to select.

1. Press MENU button continuously until select FUN menu.

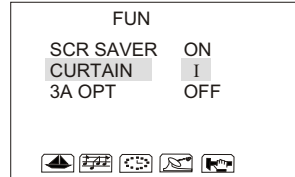

2. Press CH+/- button, and move the indicator to CURTAIN, then press VOL+/- button to select from I, II to III.

I: curtain

II : fade in and fade out

III: mixed I and II

Note: You can select 3A OPT ON or OFF, when you select ON, the color enhances.

CALENDAR



How to use the calendar function

This TV set has been designed to store the calendar from the year 1901 to 2050.

1. Press the CALENDAR button and then the calendar will appear on the screen (Press the CALENDAR button again to conceal the display), the display time is 10s.

AUG 2006						
SU	MO	TU	WE	TH	FR	SA
		1	2	3	4	5
6	7	8	9	10	11	12
13	14	15	16	17	18	19
20	21	22	23	24	25	26
27	28	29	30	31		

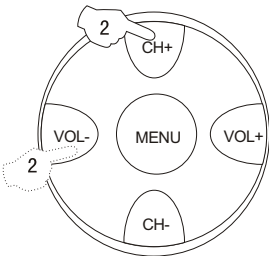

2. Press CH+/- button to adjust the YEAR, press VOL+/- button to adjust the MONTH.

Setting the other Function(continued)

- The function of channel exchange will enable you to exchange any two programs and you can conveniently adjust the order of the programs due to your own need.

Channel exchange

Channel Exchange

(for example, to change between channel1 and 9)

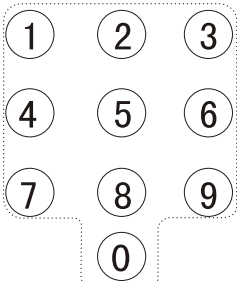
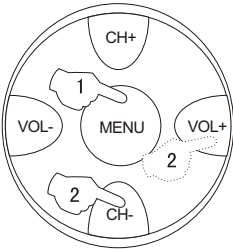

Direct-digit Choosing Button

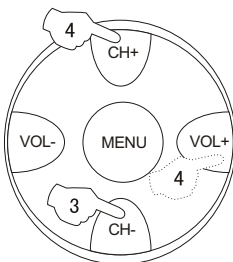

1. Press MENU button continuously until select TUN menu.

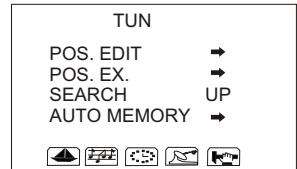

2. Press CH+/- button, move the indicator to POS.EX., Then press VOL+ button to enter the sub-menu.

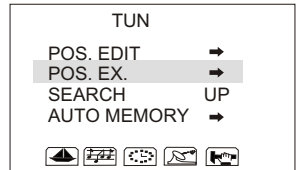

3. Press CH+/- button, move the indicator to EX.POS1, then press VOL+/- button to set the channel number to 1.

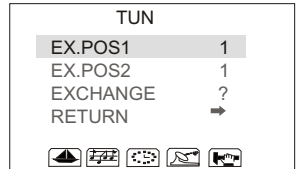

4. Press CH+/- button, move the indicator to EX.POS2, then press VOL+/- button to set the channel number to 9.

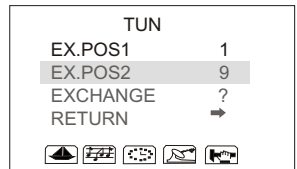

5. Press CH+/- button, move the indicator to EXCHANGE, then press VOL+/- button to confirm. Then the programs of the two channel will be exchanged.

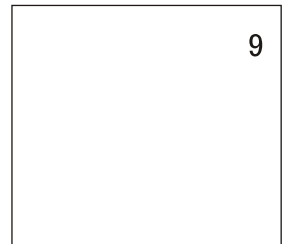

Setting the Lock

- This TV set provides you with the LOCK function, you can choose it due to your need to protect your TV set.

Changing your password

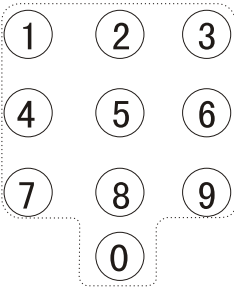
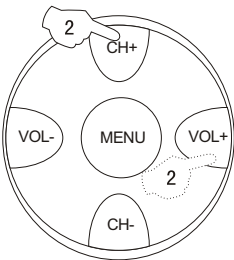
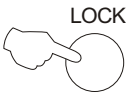

Direct-digit Choosing Button

Changing your password

This TV set can set a four digit password, the original one is 0000, if you want to reset it, please follow the instructions below.

1. Press LOCK button, the screen will show as the form on the right.

LOCK SET UP	
PASSWORD: ----	
CHANGE PW.	→
TUNING LOCK	OFF
PRESET PROG.	OFF
AV LOCK	OFF
CHILD LOCK	OFF
MAX. VOLUME	OFF
UNLOCK	→

2. Press the 0 button for four times, and enter the menu of LOCK setting. Press CH+/- button and move the indicator to CHANGE PW. , and press VOL+ button to enter the sub-menu of CHANGE PW.

LOCK SET UP	
PASSWORD: ----	
CHANGE PW.	→
TUNING LOCK	OFF
PRESET PROG.	OFF
AV LOCK	OFF
CHILD LOCK	OFF
MAX. VOLUME	OFF
UNLOCK	→

3. Press the Direct-digit Choosing button and input a four-digits password.

CHANGE PW.	
NEW PW.: ----	

4. After inputting the new password, return to the original status as shown on the right form, then, you can input the new password to enter the menu of LOCK.

LOCK SET UP	
PASSWORD: ----	
CHANGE PW.	→
TUNING LOCK	OFF
PRESET PROG.	OFF
AV LOCK	OFF
CHILD LOCK	OFF
MAX. VOLUME	OFF
UNLOCK	→

Note: After changing the password, please remember the new password, or you can not use this function in future.

Setting the Lock(continued)

Setting the Lock

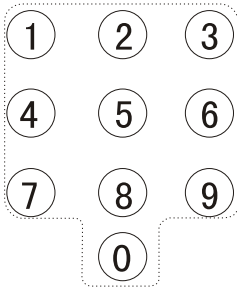
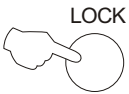

Direct-digit Choosing Button

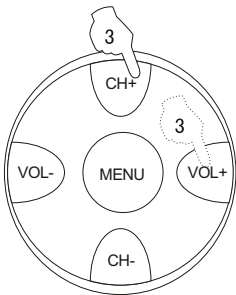

Setting the Lock

There are TUNING LOCK, PRESET PROG. ,AV LOCK, CHILD LOCK and MAX.VOLUME five lock setting, you can set it due to your need.

1. Press the LOCK button, the screen will show as the form on the right.

LOCK SET UP	
PASSWORD: ----	→
CHANGE PW.	→
TUNING LOCK	OFF
PRESET PROG.	OFF
AV LOCK	OFF
CHILD LOCK	OFF
MAX. VOLUME	OFF
UNLOCK	→

2. Press the Direct-digit Choosing button 0 for four times(or input the password you set), and enter the menu of LOCK.

LOCK SET UP	
PASSWORD: ----	→
CHANGE PW.	→
TUNING LOCK	OFF
PRESET PROG.	OFF
AV LOCK	OFF
CHILD LOCK	OFF
MAX. VOLUME	OFF
UNLOCK	→

3. Press CH+/- button, move the indicator to TUNING LOCK, then press VOL+ button to set it ON or OFF.

LOCK SET UP	
PASSWORD: ----	→
CHANGE PW.	→
TUNING LOCK	OFF
PRESET PROG.	OFF
AV LOCK	OFF
CHILD LOCK	OFF
MAX. VOLUME	OFF
UNLOCK	→

Note:

1. When the TUNING LOCK is set ON, if you want to enter the TUNING menu, you will have to type the password.
2. The PRESET PROG allows you to turn on the TV always with one channel.
3. When AV LOCK is set ON, AV cannot be used, hence the screen will change into black and indicate that it has been locked. The TV set will be in the status of mute.
4. When the CHILD LOCK is set ON, if the buttons on the TV are pressed, it will indicate that the TV set is in the status of CHILD LOCK, and the buttons won't work.
5. The MAX VOLUME allows you to set a figure of the top limit of volume.
6. The UNLOCK allows you to set all the lock to OFF.

Game

- This TV set provides you with the game, after entering the game, except the buttons that are appointed in the game(for example, the game button, CH+/-and MODE, etc.)and the DC Stand by button, the other buttons cannot be used.

Game control buttons and method of playing the game

Game control buttons

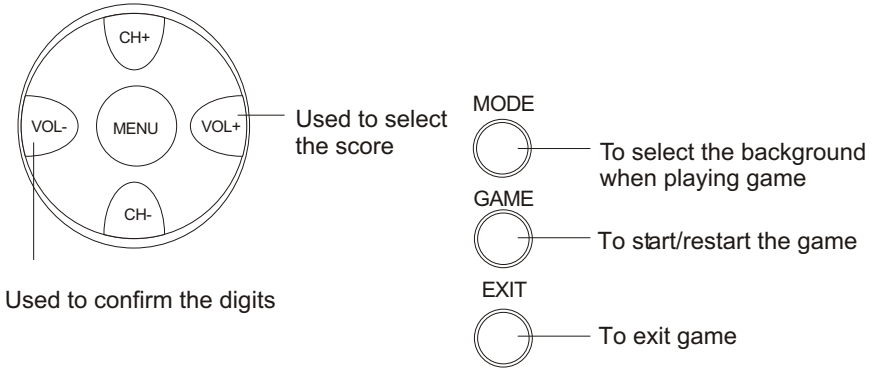

Method of playing the game

1. Press GAME button to start the game screen, then press VOL+ button to select the score of BET(1-10)(the score will decrease as much as the value of BET). After these operation you could press VOL- button to enter the game , the digits and flag will change quickly.

2. Press VOL+ button to enter after select a digit(1-8), and then the selection of the second digit, press VOL+ button again to start the second digit selection. REACH will display on the screen if 2 is also selected; and WIN will display on the screen if 2 is selected on the third position, and the score will also display on the screen.

3. You can press the GAME button to restart the game when it is game over or during the process of the game.

Note: WIN displays on the screen on the following condition, and the score is as following:

The three position	Score
Two 7(7 appears on two position)	5
Two flags	10
Three 7	200
Three flags	300
Three other digits except 7	100

1	5	7
BET	00	POINT
SCORE	000200	POINT
	←	→
START		BET

2	2	7
REACH		
BET	02	POINT
SCORE	000198	POINT
	←	→
START		BET

2	2	2
WIN		
ODDS	X	100
BET	02	POINT
SCORE	000198	POINT
	←	→
START		BET

Connecting Additional Equipments

Connecting additional equipments

- You can connect the DVD, VCR and stereo system to the AV output to enjoy a higher quality of picture and sound effect.

➤ Signal flow

- Ⓜ White (Audio left channel)
- Ⓡ Red (Cr and audio right channel)
- Ⓟ Blue (Cb)
- Ⓞ Green (Y)
- Ⓢ Yellow (Video)

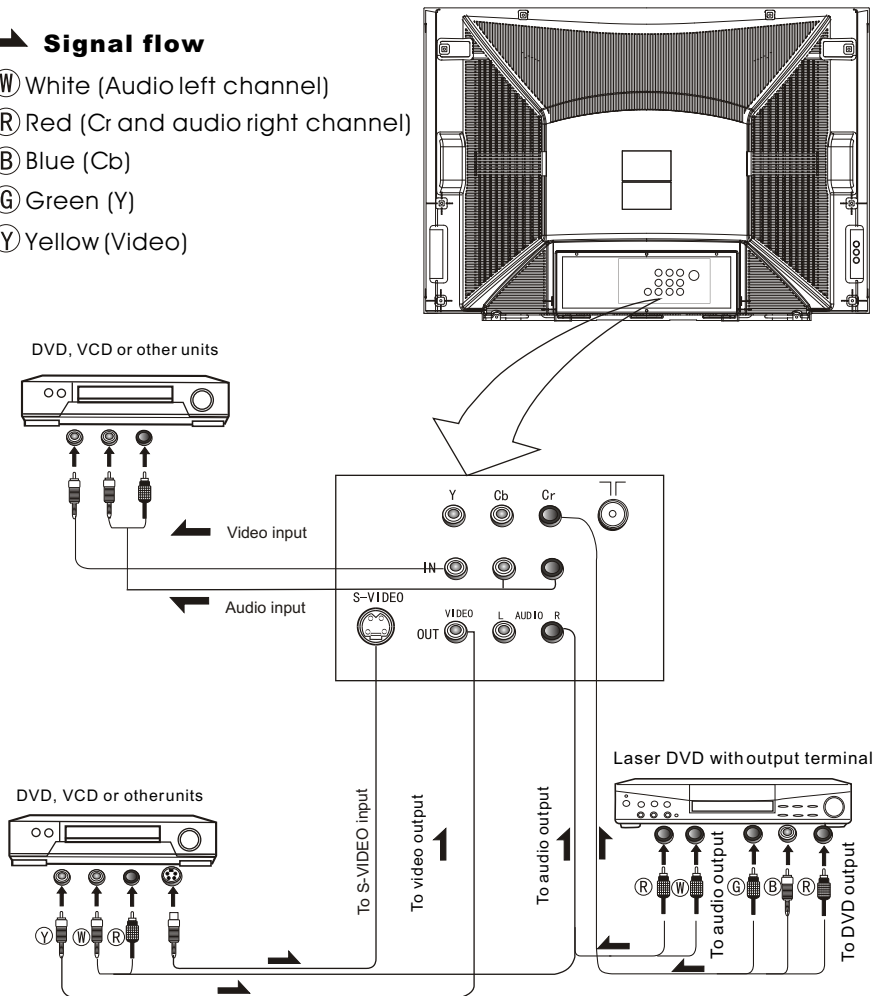

















Note: About the S-VIDEO

1. When receive s-video signal, you must remove video signal; when receive video signal, you must remove s-video signal.
2. When receive side video signal, you must remove back video signal; when receive back video signal, you must remove side video signal.

Troubleshooting

*To assist in location possible faults use help guide below.

BREAKDOWN PHENOMENON		CHECKING
PICTURE	SOUND	
 <p>Picture with snow</p>	 <p>Noise</p>	The aerial direction and connection
 <p>Double or Triple Image</p>	 <p>Normal</p>	This is called ghosting which can be minimized with an outside aerial, and good quality cable and terminations. Altering the aerial direction can also minimize this effect.
 <p>Disturb</p>	 <p>Noise</p>	Electrical interference which can be caused by cars, motorbikes etc, Fluorescent lamps and dirty insulators on overhead power cables.
 <p>Normal</p>	 <p>No sound</p>	Volume, Sound mute
 <p>No Picture</p>	 <p>No sound</p>	Ensure that the power supply is connected to the TV set and turned on. Also ensure that the TV set is not in "PICTURE MUTE" or that the brightness and contrast are not turned down
 <p>No color</p>	 <p>Normal volume</p>	Adjust color control
 <p>Scramble</p>	 <p>Normal or Weak Volume</p>	Adjust channel again
 <p>Color Spot</p>	 <p>Normal volume</p>	Colour Purity fault which can be caused by moving the TV set, placing magnets near the TV screen or turning on/off house hold appliances such as vacuum cleaners near the TV set. Turn the TV off with the mains power switch for 15 minutes. When the power is turned on again the TV set will automatically degauss the picture. In severe cases leave the TV set turned off overnight.

Note:

- 1.If the fault can not be repaired using the above guide consult with your local authorized service center.
- 2.The TV set must only be repaired by a qualified registered service person. Never attempt to remove the back cover as the TV set has dangerous voltages in side that may cause a fatality or fire.
3. The cabinet may produce the occasional "snapping sound". This is normal and caused by the materials in the cabinet expanding with room temperature changes.

Specifications

*The specifications offered you here are only for reference and, with the improvement of the products ,there may be some different between the description and the practicality.

Specifications

Color system	PAL NTSC3.58/4.43(AV)
Sound system	BG DK I M
Picture tube	29" color picture tube(the viewable dimension is 68 cm)
Sound output power	5W+5W
Power requirements	See rating plate
Power consumption	See rating plate
Dimension (mm)	830 (W) x 402 (D) x 583 (H) (mm)
Environment conditions	Working temperature: +5℃ ~+35℃ Working humidity: 20%-80% Storage temperature: -15℃ ~+45℃ Storage humidity: 5%-90%
Accessories	Remote control X1 Owner's manual X1 Battery(AA) X2

NOTE

Design and specifications are subject to change without notice.
The dimension in this manual is an approximation.

Free Manuals Download Website

<http://myh66.com>

<http://usermanuals.us>

<http://www.somanuals.com>

<http://www.4manuals.cc>

<http://www.manual-lib.com>

<http://www.404manual.com>

<http://www.luxmanual.com>

<http://aubethermostatmanual.com>

Golf course search by state

<http://golfingnear.com>

Email search by domain

<http://emailbydomain.com>

Auto manuals search

<http://auto.somanuals.com>

TV manuals search

<http://tv.somanuals.com>