

# Haier

## LCD TV RECEIVER

---

## USER'S MANUAL



Please read this manual carefully before using your television and keep this manual in a good place for future reference.

MODEL:  
LT19A1,LT22A1  
LT26A1,LT32A1  
LT42A1



# TABLE OF CONTENT

FOR YOUR SAFETY .....	2
PRECAUTIONS AND REMINDERS .....	3
IMPORTANT SAFETY INSTRUCTIONS .....	4
PACKAGE CONTENTS.....	5
PREPARATION.....	6
PREPARING YOUR LCD HDTV FOR WALL MOUNTING .....	6
PERIPHERAL CONNECTION GUIDE .....	8
OPERATING INSTRUCTIONS.....	9
TO USE THE FRONT PANEL CONTROL.....	9
TO USE THE REMOTE CONTROL.....	10
VIEWING MODE ILLUSTRATIONS.....	12
CONNECTING EQUIPMENT .....	13
TO USE THE MENUS .....	19
PICTURE MENU.....	19
SOUND MENU.....	20
TV MENU .....	20
FEATURES MENU .....	21
PARENTAL MENU .....	22
COMMON INTERFACE MODULE .....	23
OAD OPERATION .....	24
TIPS.....	25
PRODUCT SPECIFICATION.....	26
BEFORE CALLING SERVICE .....	28
GLOSSARY .....	29
APPENDIX .....	30
INFORMATION.....	32

SYMBOL	SYMBOL DEFINITION
 <p data-bbox="236 300 336 327">SA 1965</p>	<p data-bbox="464 163 1465 365"><b>DANGEROUS VOLTAGE:</b> The lightning flash with arrowhead symbol, within an equilateral triangle, is intended to alert the user to the presence of uninsulated “dangerous voltage” within the product’s enclosure that may be of sufficient magnitude to constitute a risk of electrical shock to persons.</p>
 <p data-bbox="236 501 336 528">SA 1966</p>	<p data-bbox="464 387 1465 542"><b>INSTRUCTIONS:</b> The exclamation point within an equilateral triangle to alert the user to the presence of important operating and maintenance (servicing) instruction in the literature accompanying the appliance.</p>

## Batteries installed warning

Caution - Danger of explosion if battery is incorrectly replaced. Replace only with the same or equivalent type.

The batteries (battery pack or batteries installed) shall not be exposed to excessive heat such as sunshine, fire or the like.

## FOR YOUR SAFETY

Before operating the TV please read this manual thoroughly. This manual should be retained for future reference.

### NOTICE

1. The changes or modifications not expressly approved by the party responsible for compliance could void the user's authority to operate the equipment.
2. Shielded interface cables and AC power cord, if any, must be used in order to comply with the emission limits.
3. The manufacturer is not responsible for any radio or TV interference caused by unauthorized modification to this equipment. It is the responsibilities of the user to correct such interference.

### WARNING:

To prevent fire or shock hazard, do not expose the TV to rain or moisture. Dangerously high voltages are present inside the TV. Do not open the cabinet. Refer servicing to qualified personnel only.

# PRECAUTIONS AND REMINDERS

Place unit on even surfaces.



Unplug immediately if other foreign materials are put inside TV box or if the TV fell down.

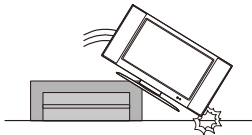

Do not cover or block any vents and openings. Inadequate ventilation may shorten the life of the display unit and cause overheating.



Unplug immediately if malfunction like no picture, no video/audio, smoke and bad odor from TV.



Prohibit/Avoid opening TV cabinet.

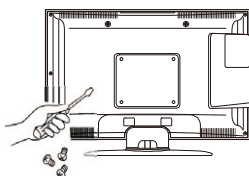

Avoid direct sunlight, dusty, high humidity and smoky areas.

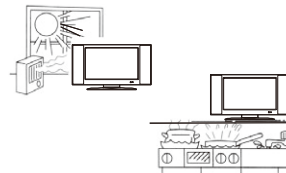

Don't throw any object inside the TV box like metals or other flammable materials.

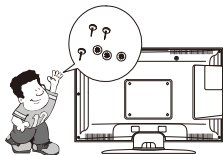

Remember to unplug the AC cord from the AC outlet before cleaning. Do not use liquid cleaners or aerosol cleaners to clean the display.



Call service personnel to clean the internal part of the TV once a year.



Don't place the TV in confined spaces or in a box when using it.

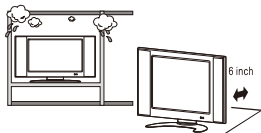

Make sure to unplug the unit when not in use for a long period of time (days).

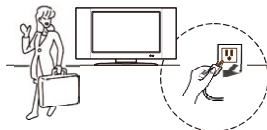

Do not place the display near water, such as bathtub, washbasin, kitchen sink, laundry tub, swimming pool or in a damp basement.

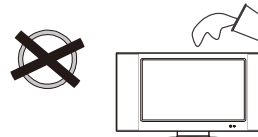

## Notice for Remote Controller

Avoid Dropping



Avoid Liquids



Avoid Aerosol Cleaners



# IMPORTANT SAFETY INSTRUCTIONS

---

## Read before operating equipment

1. Read these instructions.
  2. Keep these instructions.
  3. Heed all warnings.
  4. Follow all instructions.
  5. Do not use this apparatus near water.
  6. Clean only with a dry cloth.
  7. Do not block any of the ventilation openings. Install in accordance with the manufacturers instructions.
  8. Do not install near any heat sources such as radiators, heat registers, stoves, or other apparatus (including amplifiers) that produce heat.
  9. Do not defeat the safety purpose of the polarized or grounding type plug. A polarized plug has two blades with one wider than the other. A grounding type plug has two blades and third grounding prong. The wide blade or third prong is provided for your safety. When the provided plug does not fit into your outlet, consult an electrician for replacement of the obsolete outlet.
  10. Protect the power cord from being walked on or pinched particularly at plugs, convenience receptacles, and the point where they exit from the apparatus.
  11. Only use attachments/accessories specified by the manufacturer.
  12. Use only with a cart, stand, tripod, bracket, or table specified by the manufacturer, or sold with the apparatus. When a cart is used, use caution when moving the cart/apparatus combination to avoid injury from tip-over.
-   
91724
13. The TV should be operated only from the type of power source indicated on the label. If you are not sure of the type of power supplied to your home, consult your dealer or local power company.
  14. Unplug this apparatus during lightning storms or when unused for long periods of time.
  15. Refer all servicing to qualified service personnel. Servicing is required when the apparatus has been damaged in any way, such as power-supply cord or plug is damaged, liquid has been spilled or objects have fallen into apparatus, the apparatus has been exposed to rain or moisture, does not operate normally, or has been dropped.
  16. The Class I apparatus shall be connected to a mains socket outlet with a protective earthing connection.
  17. The mains plug or appliance coupler is used as the disconnect device, the disconnect device shall remain readily operable.
  18. **CAUTION** – These servicing instructions are for use by qualified service personnel only. To reduce the risk of electric shock, do not perform any servicing other than that contained in the operating instructions unless you are qualified to do so.
  19. For use only with Listed Wall Mount Bracket with minimum weight/load: Please see page.26
  20. Tilt/Stability – All televisions must comply with recommended international global safety standards for tilt and stability properties of its cabinets design.
    - Do not compromise these design standards by applying excessive pull force to the front, or top, of the cabinet, which could ultimately overturn the product
    - Also, do not endanger yourself, or children, by placing electronic equipment/toys on the top of the cabinet. Such items could unsuspectingly fall from the top of the set and cause product damage and/or personal injury.

21. Wall or Ceiling Mounting – The appliance should be mounted to a wall or ceiling only as recommended by the manufacturer.
22. Power Lines – An outdoor antenna should be located away from power lines.
23. Outdoor Antenna Grounding – If an outside antenna is connected to the receiver, be sure the antenna system is grounded to provide some protection against voltage surges and built up static charges. Section 810 of the National Electric Code, ANSI/NFPA No. 70-1984, provides information with respect to proper grounding of the mats and supporting structure grounding of the lead-in wire to an antenna-discharge unit, size of grounding connectors, location of antenna discharge unit, connection to grounding electrodes and requirements for the grounding electrode. See Figure below.

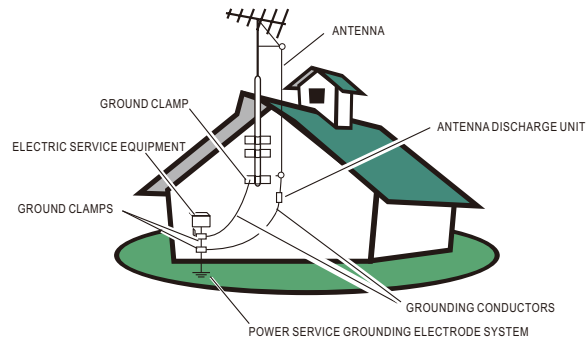

**EXAMPLE OF ANTENNA GROUNDING AS PER NATIONAL ELECTRICAL CODE** Note to the CATV system installer: This reminder is provided to call the CATV system installer's attention to Article 820-40 of the NEC that provides guidelines for proper grounding and, in particular, specifies that the cable ground shall be connected to the 6 English grounding system of the building, as close to the point of cable entry as practical. Please, make sure to connect the power plug to the wall outlet socket after connecting the TV to the adapter!

24. Apparatus shall not be exposed to dripping or splashing and no objects filled with liquids, such as vases, shall be placed on the apparatus.
25. Excessive sound pressure from earphones and headphones can cause hearing loss. Adjustment of the equalizer to maximum increases the earphones and headphones output voltage and therefore the sound pressure level.

## PACKAGE CONTENTS

- TV unit
- Remote Control
- Two (AAA) Batteries for the Remote Control
- Power Cord
- User Manual
- Quick Setup Guide

## PREPARATION

**IMPORTANT:** Do not apply pressure to the screen display area which may compromise the integrity of the display. The manufacturer's warranty does not cover user abuse or improper installations.

### PREPARING YOUR LCD HDTV FOR WALL MOUNTING

We suggest that you keep your TV at least 2.36 inches (60 mm) from the wall to prevent cable interference.

Before mounting your TV on the wall, you need to remove the base.

For your safety, please use listed wall mount bracket with minimum weight of the TV without stand. (Please see page.26)

To attach a wall mount bracket to your TV:

- 1 Loosen the screws holding your TV to the stand and remove the stand base from the TV.
- 2 Secure the wall mount bracket to the back of your TV using four screws, as indicated in the illustration.

#### For 19"/22" model

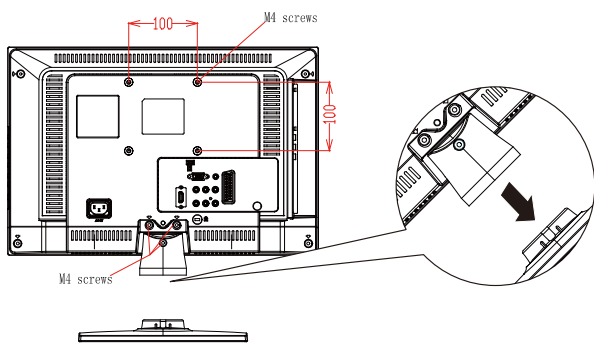

#### For 26" model

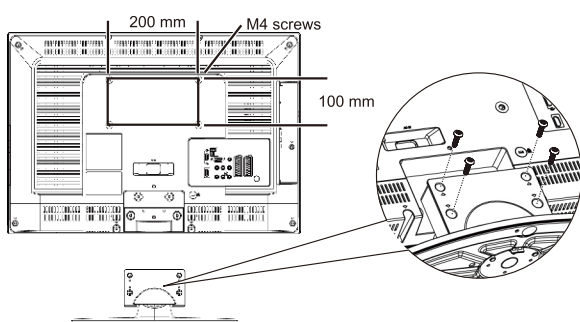

#### For 32" model

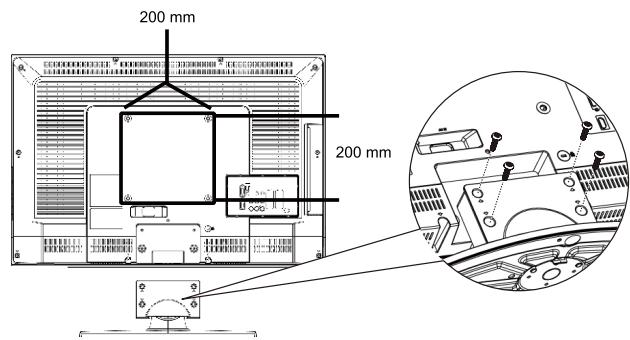

#### For 42" model

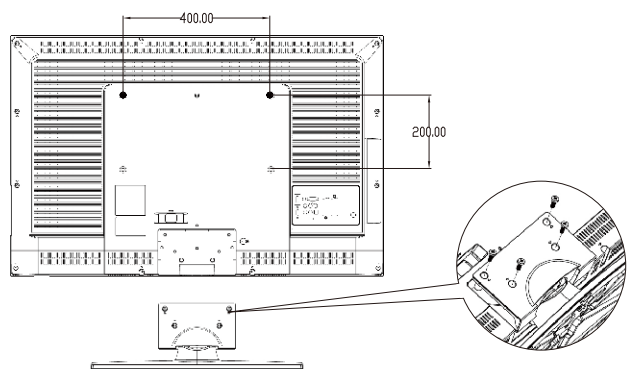

#### NOTE

- ▶ Wall mount bracket & screws are not included.

Please make sure to connect the power plug to the wall outlet socket after connecting the TV to the power cord!

1. **Install the base stand; place the TV on a solid surface.**

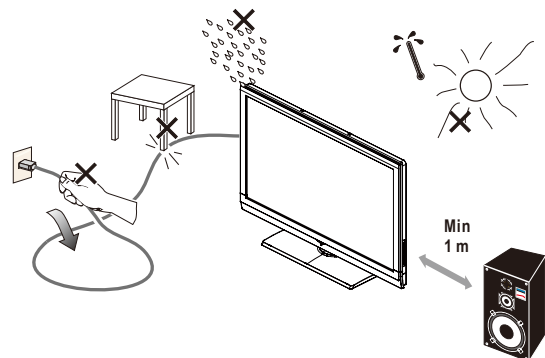

Ensure that the TV is placed in a position to allow free flow of air. Do not cover the ventilation openings on the back cover. To prevent any unsafe situations, no naked



flame sources, such as lighted candles, should be placed on or in the vicinity. Avoid heat, direct sunlight and exposure to rain or water. The equipment shall not be exposed to dripping or splashing.

2. Connect the antenna cable or CATV cable to the aerial socket **TV ANTENNA** at the back of the TV set.

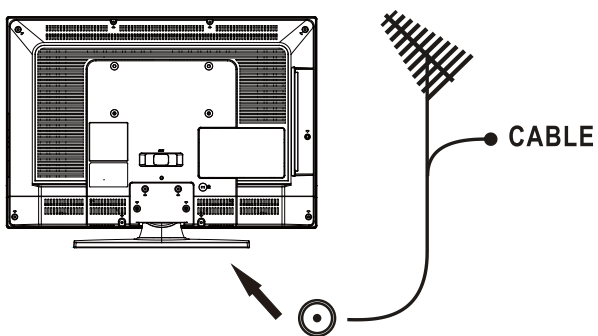

3. **Remote control:**  
Remove the cover of the battery compartment. Insert the 2 batteries supplied (Type AAA 1.5V).

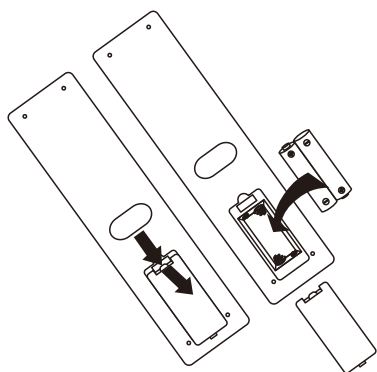

4. **Power:**  
Insert the power cord in the wall socket with AC power supply. You can see LED states at the front panel. If the LED colour is Blue, means the TV set is power on. If the LED colour is Red, which means this TV set is in standby state.
5. **Turn the TV on:**  
Press the POWER key on the Remote control or the side panel control knobs.

The TV will be turned on in a minute with display on the screen.

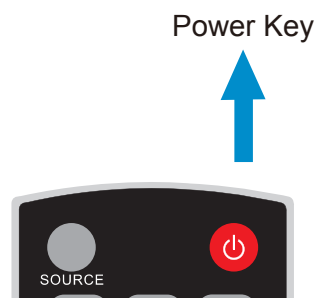

# PERIPHERAL CONNECTION GUIDE

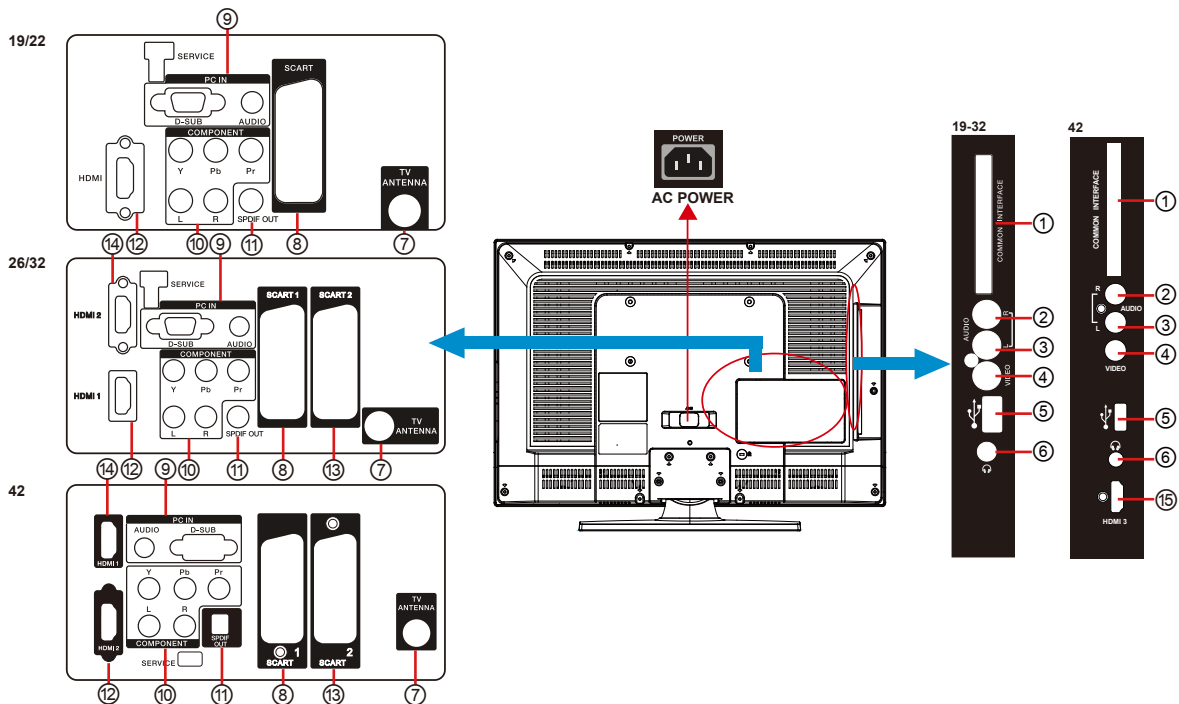



- ① **COMMON INTERFACE (CI)** – Conditional Access Module (CAM) use only. Please contact your service provider for details.
- ②、③、④ **AV IN** – Connect the primary source for composite video devices, such as a VCR or video game. Use the white and red connectors to connect the external audio from the same source.
- ⑤ **USB** – Support multimedia input for .MP3 and .JPEG file.
- ⑥ **Earphone Output** – Connect to the headphones. When the headphone is inserted to the plug, all the speakers will be muted.
- ⑦ **TV ANTENNA** – Connect to an antenna or digital cable (out-of-the-wall, not from Cable Box) for Digital TV.\*
- ⑧、⑬ **SCART** – Connect the video recorder or decoder to the television. Full SCART transmits RGB, CVBS video in/out, and audio in/ out; HALF SCART transmits S-Video, CVBS video in/out, and audio in/ out.  
**Note 1:** 19"/22" model only has one SCART port.  
**Note 2:** SCART1/2 has monitor out. (CVBS/YPbPr/ATV/DTV)
- ⑨ **PC IN** – Connect the video and audio cables from a computer here.
- ⑩ **COMPONENT (Y/Pb/Pr with Audio L/R)** – Connect the primary source for component video devices such as a DVD Player or set top box here.
- ⑪ **SPDIF (Digital Audio Out)** – When a digital audio signal is associated with the input selected for viewing, the digital audio will be available on this SPDIF connection to your home theatre system.
- ⑫、⑭、⑮ **HDMI** – Connect the primary source for digital video such as a DVD multimedia player or set top box through this all digital connector.  
**Note:** 19"/22" model only has one HDMI port.

Once your equipment is connected, use the following procedure to view the input signal: Press the SOURCE button on the remote controller to select the relevant source to view. (ex: Press YPbPr button to select "YPbPr" if you have connected a video recorder to Component socket.)

# OPERATING INSTRUCTIONS

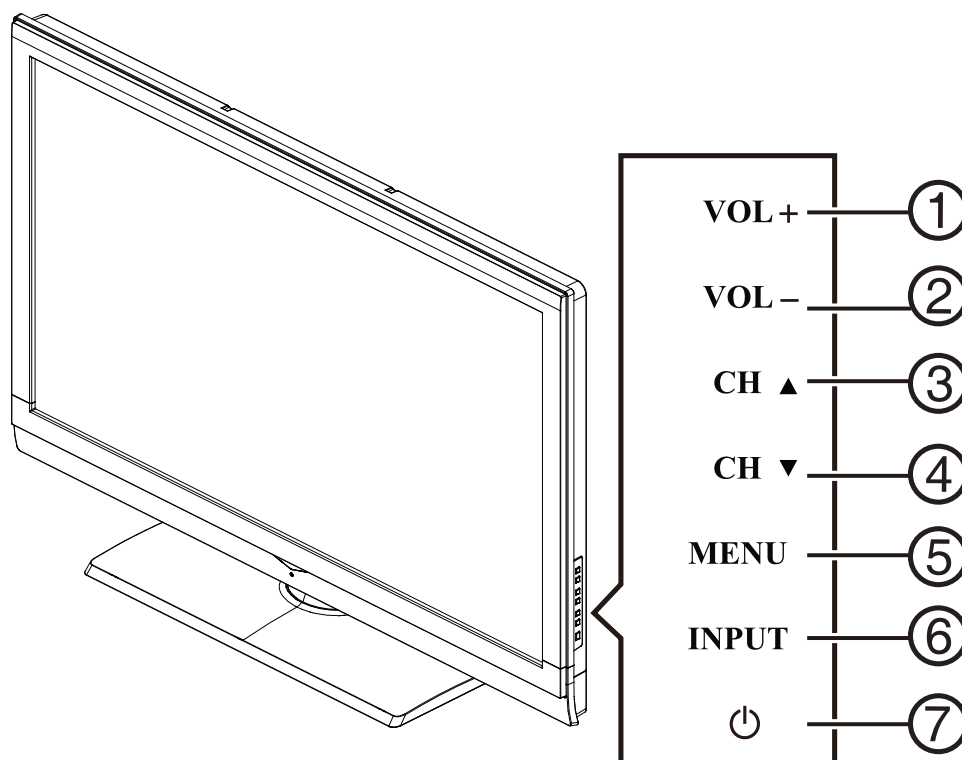
## TO USE THE FRONT PANEL CONTROL



1	VOL +	<b>VOL +:</b> Press to increase the sound volume level.
2	VOL -	<b>VOL - :</b> Press to decrease the sound volume level.
3	CH ▲	<b>CH ▲:</b> Press to select the next higher Programme number.
4	CH ▼	<b>CH ▼:</b> Press to select the next lower Programme number.
5	MENU	<b>Menu key:</b> Press to open or exit the OSD (on-screen display) menu.
6	INPUT	<b>Input key:</b> Press to select the input source.
7	 POWER	<b>Power key:</b> Press to turn on / off (standby) the TV set. (Press to turn on TV after the power on status, LED had changed to the Blue colour and stopped flashing.)

## TO USE THE REMOTE CONTROL

### POWER

Press to turn ON/OFF (standby) the TV.

### SOURCE

Press repeatedly to choose the various input sources.

### Number buttons

Press to enter TV channel number to select channel.

### EPG

Press to display the Electronic Programme Guide.

### PRE CH

Press to display the previous channel.

### HDMI

Press to choose HDMI source mode.

### YPbPr

Press to choose YPbPr source mode.

### VIDEO

Press to choose AV source mode.

### PC

Press to choose PC source mode.

### VOL+ /VOL-

Press + or - to adjust the volume.

### CH ^ / CH v

Press ^ or v to browse through the TV channels.

### MUTE

Switch the sound ON/OFF.



### ZOOM

Select the display aspect from Auto, Normal (4:3), Wide (16:9), subtitle, full screen, or 14:9 mode.

### DUAL

Press to select from mono, stereo, Dual I, or Dual II.

### AUDIO ADJ

Press to choose from Personal, Speech, Music.

### VIDEO ADJ

Press to choose the Smart Picture mode from Personal, Standard, Movie, Vivid, Eco.

### SLEEP

Press to set the preset time to switch the TV to standby mode automatically.

### MENU/EXIT

Press to open or close menu.

### ▲, ▼, ◀, ▶, OK

Press to adjust or confirm the various function items on the menu.

### INFO

Press to display or close the information screen.

### Colour buttons

- In TV mode: Follow the directions in the OSD screen.
- In Text mode: Text control buttons.

## TELETEXT

Press to display or close the Teletext.

## MIX

Display the Teletext with TV.

## SIZE

Press to change the font size: Full screen, Top half and Bottom half.

## SUBPAGE

Display the sub page (when available).

## INDEX

Press to return to page 100 or the index page.

## SUBTITLE

- In TV mode: It works only for turning on the subtitle and change to the next page marked as subtitle.
- In Text mode: Select the next page marked as a subtitle page and request it as the display page.

## HOLD

Press to stop the scrolling of pages. The text decoder stops receiving data.

## REVEAL

Reveal hidden information such as answers to a quiz.

## FAV

Display the Favourite Channel List.

## CH-LIST

Display the Channel List.

## USB

Press USB to display the multimedia selection screen.

## FREEZE

Press to freeze the TV picture.



## VIEWING MODE ILLUSTRATIONS

### Normal Mode

The original content would be at the centre of the screen.

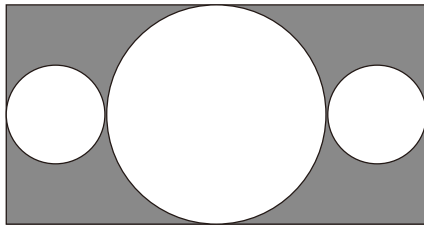

16:9 Content

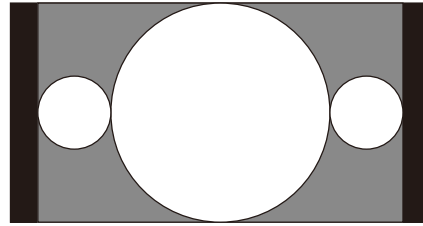

4:3 Content

### Wide Mode

The original content in this mode has to fill the entire screen of the display.

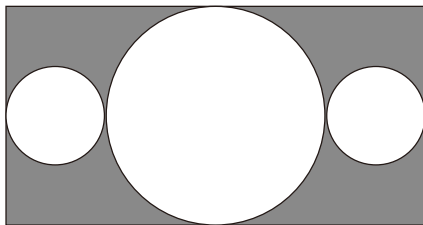

16:9 Content

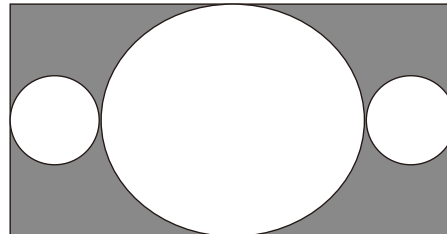

4:3 Content

### ZOOM Mode

For those wide format images which are originally programmed into 4:3 frames with black bars around, this mode would stretch the image in both width and height for full display with active data.

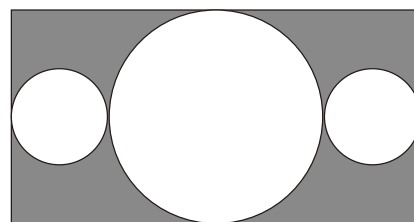
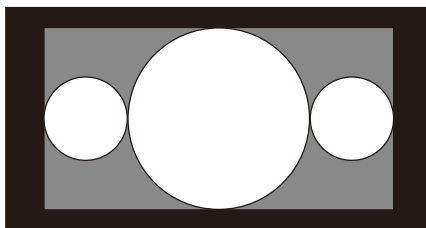

Same image in ZOOM mode

## CONNECTING EQUIPMENT

### Coaxial (RF)

#### Using Your Antenna or Digital Cable for DTV.

19"/22"/26"/32"

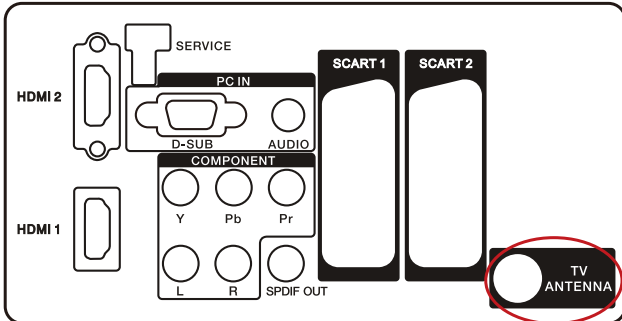

42"

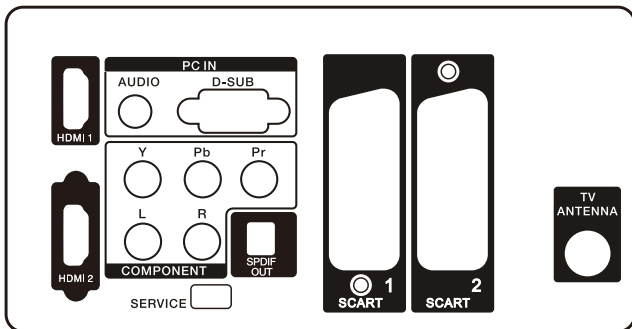

1. Turn off the HDTV.
2. Connect the coaxial (RF) connector from your antenna or digital cable (out-of-the-wall, not from the Cable Box) to the TV ANTENNA connector.
3. Turn on the HDTV.
4. Select ATV/DTV using the SOURCE button on the remote control or the control key on the side of the TV.

#### Using Your Antenna or Cable for DTV.

19"/22"/26"/32"

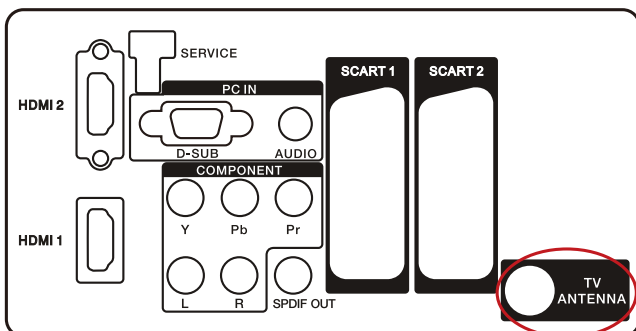

42"

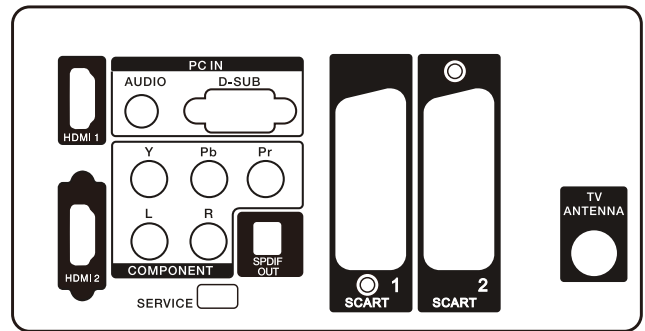

1. Turn off the HDTV.
2. Connect the coaxial (RF) connector from your antenna or cable (out-of-the-wall, not from the Cable Box) to the TV ANTENNA connector at the rear of the HDTV.
3. Turn on the HDTV.
4. Select ATV/DTV using the SOURCE button on the remote control or the control key on the side of the TV.

#### Using the Antenna or Cable for your VCR

19"/22"/26"/32"

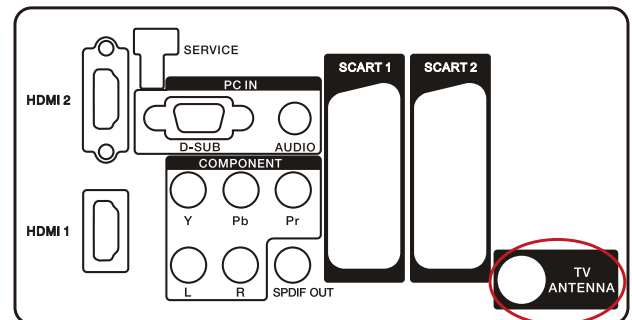

42"

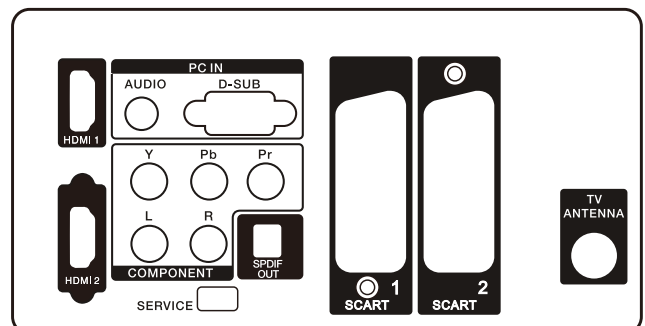

1. Turn off the HDTV and VCR.
2. Connect the "Output to TV", "RF Out" or "Antenna Out" connector on the rear of your VCR to the TV ANTENNA connector at the rear of the HDTV.
3. Turn on the HDTV and VCR.

4. Select ATV/DTV using the SOURCE button on the remote control or the control key on the side of the TV.

**NOTE**

- ▶ If you have an off-air antenna or cable TV, connect it to the "Antenna In" connector on the rear of your VCR.

### Connecting Your HDTV Set-Top Box Using HDMI (19"/22" only have one HDMI)

HDTV Set-Top Boxes that have a HDMI digital interface should be connected to the HDMI input of the LCD HDTV for optimal results.

### Connecting your HDTV Set-Top Box (Best)

19"/22"/26"/32"

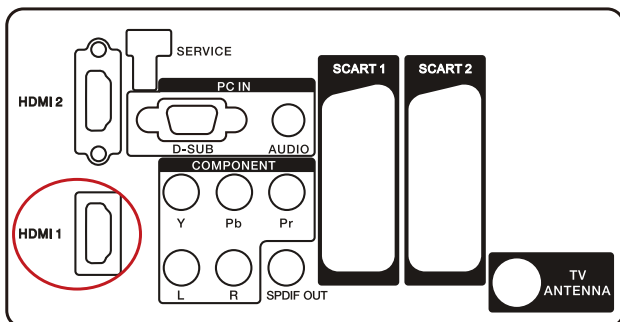

42"

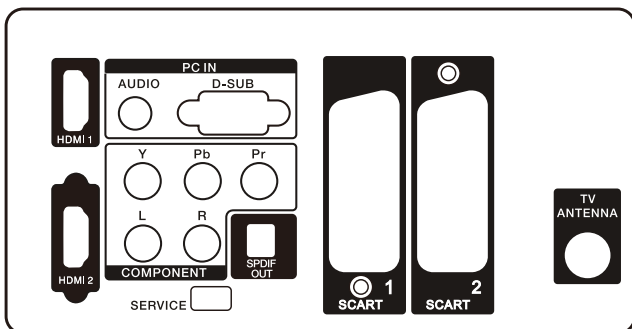

1. Turn off the HDTV and HDTV Set-Top Box.
2. Connect a HDMI cable to the HDMI output of your HDTV Set-Top Box and the other end to the HDMI Input at the rear of the HDTV.
3. Turn on the HDTV and HDTV Set-Top Box.

4. Select HDMI using the SOURCE button on the remote, side of the HDTV, or directly by pressing the HDMI button on the Remote Control.

**NOTE**

- ▶ The HDMI input on the HDTV supports High-bandwidth Digital Content Protection (HDCP). HDCP encrypts the transmission between the video source and the digital display for added security and protection.
- ▶ Refer to your HDTV Set-Top Box user manual for more information about the video output requirements of the product or consult your cable or satellite operator.

### For HDTV Set-Top Boxes with DVI

1. Turn off the HDTV and HDTV Set-Top Box.
2. Using a HDMI-DVI cable, connect the DVI end to your HDTV Set-Top Box and the HDMI end to the HDMI Input at the rear of the HDTV.
3. Turn on the HDTV and HDTV Set-Top Box.
4. Select HDMI using the SOURCE button on the remote, side of the HDTV, or directly by pressing the HDMI button on the Remote Control.

**NOTE**

- ▶ The HDMI input on the HDTV supports High-bandwidth Digital Content Protection (HDCP). HDCP encrypts the transmission between the video source and the digital display for added security and protection.
- ▶ Refer to your HDTV Set-Top Box user manual for more information about the video output requirements of the product or consult your cable or satellite operator.
- ▶ The DVI to HDMI connection provides video only. Connection to an alternate audio player is required for audio.



## Using Component Video

### Connecting your HDTV Set-Top Box (Better):

19"/22"/26"/32"

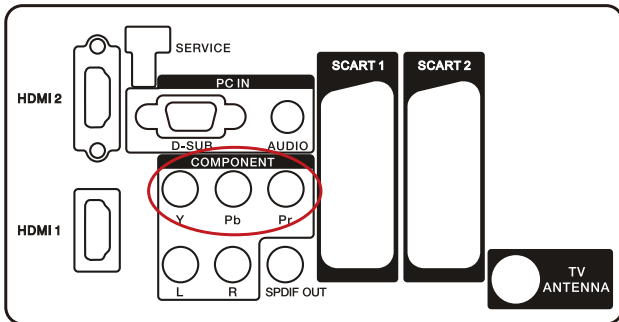

42"

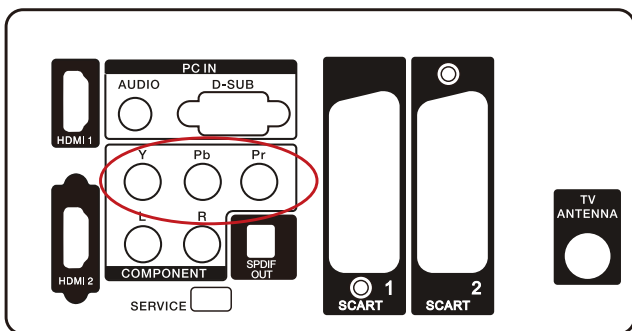

1. Turn off the HDTV and HDTV Set-Top Box.
2. Connect the Pr (red colour) connector on your HDTV Set-Top Box to the corresponding Pr (red colour) connector in the Component group.
3. Connect the Pb (blue colour) connector on your HDTV Set-Top Box to the corresponding Pb (blue colour) connector in the Component group.
4. Connect the Y (green colour) connector on your HDTV Set-Top Box to the corresponding Y (green colour) connector in the Component group.
5. Using an audio cable (red and white connectors), connect the cable to the audio output connectors associated with the Component output on your HDTV Set-Top Box and connect the other end to the audio connectors associated with the Component.
6. Turn on the HDTV and HDTV Set-Top Box.

7. Select YPbPr using the SOURCE button on the remote, side of the HDTV or directly by pressing the YPbPr button on the Remote Control.

#### NOTE

- ▶ Refer to your HDTV Set-Top Box user manual for more information about the video output requirements of the product or consult your cable or satellite operator.

## Connecting Your Basic Set-Top Box

### Using Composite Video



1. Turn off the HDTV and Set-Top Box.
2. Using an AV Cable, connect the Video (yellow colour) connector on your Set-Top Box to the corresponding Video (yellow colour) connector in the AV group at the side of the HDTV.
3. Using the red and white connectors, connect the cable to the audio output connectors associated with the Video output on your Set-Top Box and connect the other end to the audio connectors associated with the AV input at the side of the HDTV.
4. Turn on the HDTV and Set-Top Box.
5. Select AV using the SOURCE button on the remote, side of the HDTV or directly by pressing the VIDEO button on the Remote Control.

## Using Coax (RF)

19"/22"/26"/32"

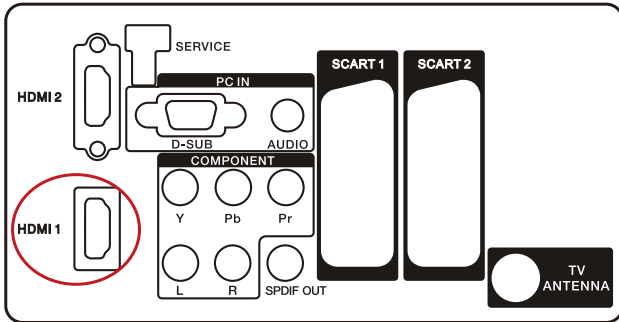

42"

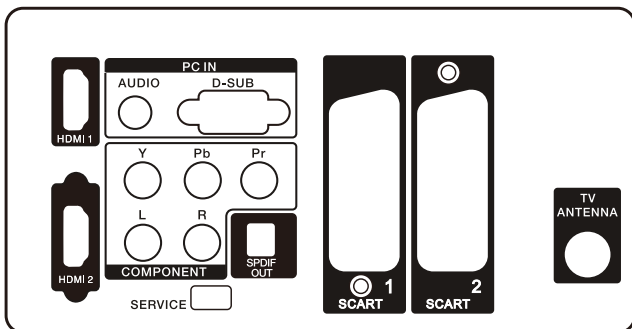

1. Turn off the HDTV and Set-Top Box.
2. Using a Coax (RF) cable, connect one end to the TV OUT (RF) on your Set Top Box and the other end to the TV input at the rear of the HDTV.
3. Turn on the HDTV and Set-Top Box.
4. Select ATV/DTV using the SOURCE button on the remote control or the control key on the side of the TV.

### NOTE

- ▶ Refer to your Set Top Box user manual for more information about selecting the video or RF output of the product.

## Connecting Your DVD Player

### Using HDMI

DVD players that have a digital interface such as HDMI (High Definition Multimedia Interface) should be connected to the HDMI input of the LCD HDTV for optimal results.

## Connecting your DVD Player (Best)

19"/22"/26"/32"

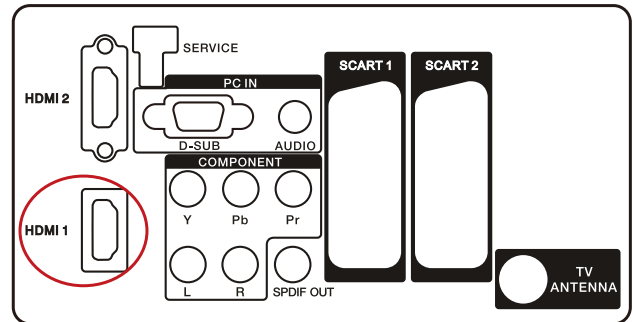

42"

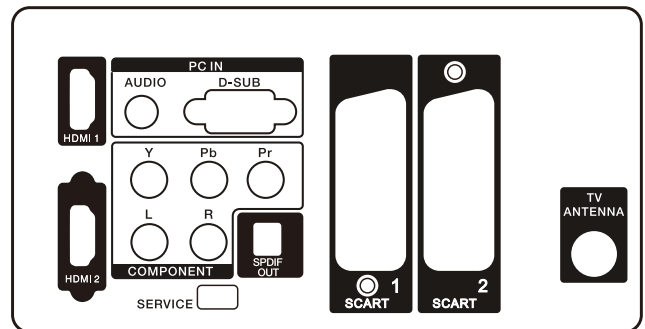

1. Turn off the HDTV and DVD player.
2. Connect a HDMI cable to the HDMI output of your DVD player and the other end to the HDMI Input at the rear of the HDTV.
3. Turn on the HDTV and DVD player.
4. Select HDMI using the SOURCE button on the remote, side of the HDTV or directly by pressing the HDMI button on the Remote Control.

### For DVD Players with DVI:

1. Turn off the HDTV and DVD player.
2. Using a HDMI-DVI cable, connect the DVI end to your DVD player and the HDMI end to the HDMI Input at the rear of the HDTV.
3. Turn on the HDTV and your DVD player.
4. Select HDMI using the SOURCE button on the remote, side of the HDTV, or directly by pressing the HDMI button on the Remote Control.

### NOTE

- ▶ Refer to your DVD player user manual for more information about the video output requirements of the product.
- ▶ The DVI to HDMI connection provides video only. Connection to an alternate audio player is required for audio output.

## Using Component Video

### Connecting your DVD Player (Better)

19"/22"/26"/32"

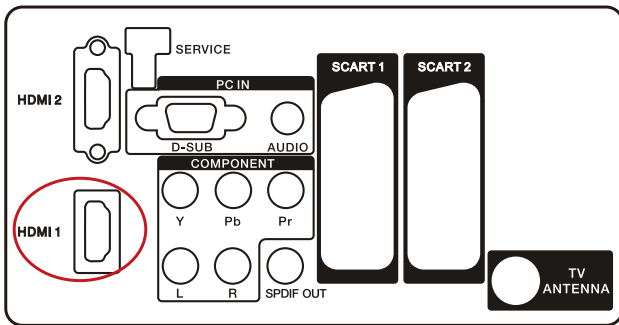

42"

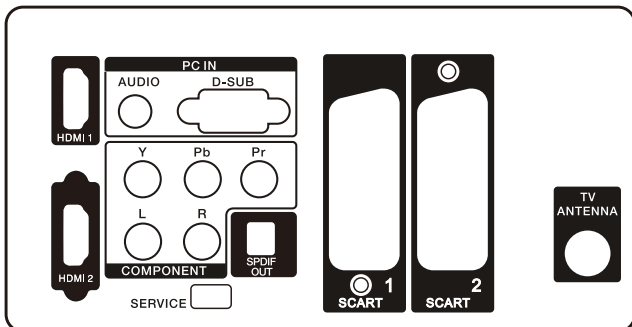

1. Turn off the HDTV and DVD player.
2. Connect the Pr (red colour) connector on your DVD player to the corresponding Pr (red colour) connector in the Component at the rear of the HDTV.
3. Connect the Pb (blue colour) connector on your DVD player to the corresponding Pb (blue colour) connector in the Component group at the rear of the HDTV.
4. Connect the Y (green colour) connector on your DVD player to the corresponding Y (green colour) connector in the Component group at the rear of the HDTV.
5. Using an audio cable (red and white connectors), connect the cable to the audio output connectors associated with the Component output on your DVD player and connect the other end to the audio connectors associated with the Component input at the rear of the HDTV.
6. Turn on the HDTV and DVD player.

7. Select YPbPr using the SOURCE button on the remote, side of the HDTV or directly by pressing the YPbPr button on the Remote Control.

#### NOTE

- ▶ Refer to your DVD player user manual for more information about the video output requirements of the product.

### Using SCART (19"/22" only support one scart)

#### Connecting your DVD Player (Good):

19"/22"/26"/32"

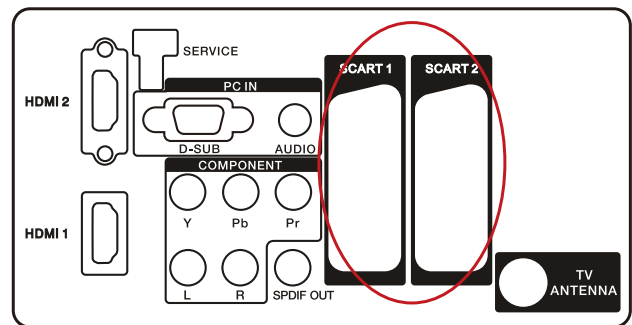

42"

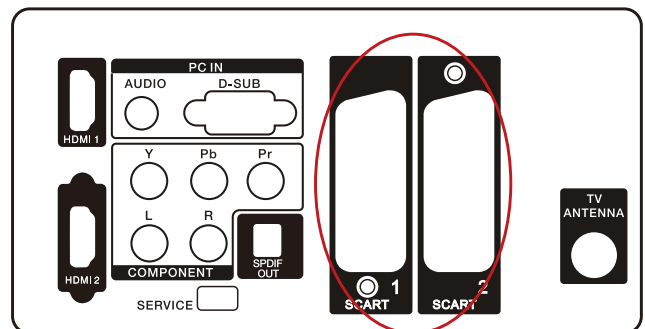

1. Turn off the HDTV and DVD player.
2. Connect the SCART socket of your DVD player to the SCART socket of the HDTV.
3. Turn on the HDTV and DVD player.
4. Select AV using the SOURCE button on the remote, side of the HDTV, or directly by pressing the VIDEO button on the Remote Control.

## Using Composite (AV) Video

### Connecting your DVD Player (Good)



1. Turn off the HDTV and DVD player.
2. Connect the Video (yellow colour) connector on your DVD player to the Video (yellow colour) connector in the AV group.
3. Connect the R (red colour) and L (white colour) audio connectors on your DVD player to the corresponding R (red colour) and L (white colour) audio input connectors in the AV group.
4. Turn on the HDTV and DVD Player.
5. Select AV using the SOURCE button on the remote, side of the HDTV or directly by pressing the VIDEO button on the Remote Control.

1. Turn off the HDTV and VCR or Video Camera.
2. Connect the SCART socket of your VCR or Video Camera to the SCART socket of the HDTV.
3. Turn on the HDTV and VCR or Video Camera.
4. Select AV using the SOURCE button on the remote, side of the HDTV or directly by pressing the VIDEO button on the Remote Control.

#### NOTE

- ▶ Refer to your VCR or Video Camera user manual for more information about the video output requirements of the product.

## Connecting to a PC

### 19"/22"/26"/32"

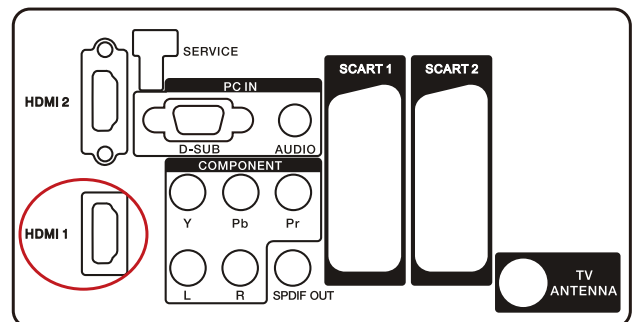

### 42"

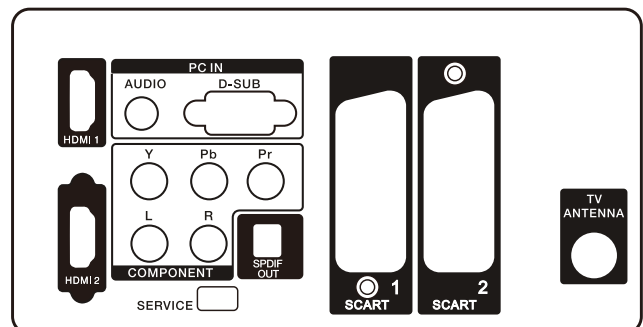

## Using SCART (19"/22" only support one scart)

### Connecting Your VCR or Video Camera

### 19"/22"/26"/32"

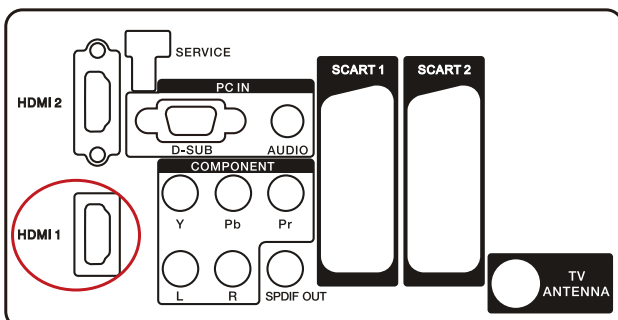

### 42"

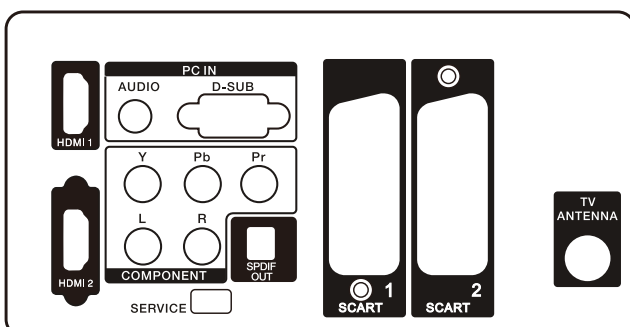

1. Turn off the HDTV and PC.
2. Connect a 15-pin D-Sub RGB (VGA) cable to the RGB output of your PC and the other end to the VGA input at the rear of the HDTV.
3. Connect the Audio Out on your computer to the AUDIO input at the rear of the HDTV.
4. Turn on the HDTV and PC.
5. Select VGA using the SOURCE button on

the remote, side of the HDTV or directly by pressing the PC button on the Remote.

### NOTE

- ▶ For the best picture quality when connecting a computer through VGA, set your computer timing mode to native resolution of panel. Please refer to the PC or graphic card's user guide for additional information on how to set the timing mode and the video output requirements of the product.

## TO USE THE MENUS

1. Press the **MENU/EXIT** button to display or close the main menu
2. Use the **Navigation Ring** to move around to select, adjust or confirm an item in the OSD (On Screen Display) menu.

Press the **MENU/EXIT** button to enter the main OSD. Adjust the items including **Picture**, **Sound**, **TV**, **Features**, and **Parental**.

However, some function items in the menus may only be enabled in the particular source modes.

## PICTURE MENU

The Picture menu in most source modes shows as below. It provides several video adjustment items for user fine tuning the video display.

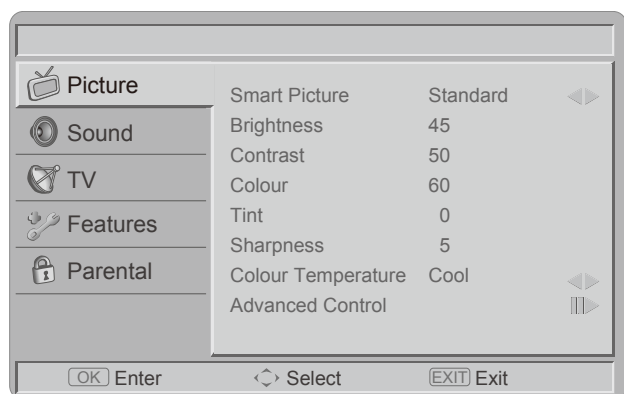

1. **Smart Picture:** To set the best picture appearance to a predefined picture

setting from Standard, Vivid, Movie, Eco, or Personal.

2. **Brightness:** To brighten the dark parts of the picture.
3. **Contrast:** To sharpen the picture quality.
4. **Colour:** To add or reduce colour.
5. **Tint:** To adjust the picture tint.
6. **Sharpness:** To improve detail.
7. **Colour Temperature:** To choose between Normal (neutral), Warm (redder), and Cool (bluer).
8. **Advanced Control:**

**[Noise Reduction]** - To filter out and reduces the image noise and improve picture quality. Select the effect degrees from Off, Low, Medium, High, or Auto.

**[Flash Tone]** - To adjust the skin colour to be more natural.

**[Back Light]** - To make the background colour brighter or darker.

**[DCR]** - Dynamic Contrast Ratio (DCR) auto adjusts the brightness of the screen to show more depths in the darker areas.

**[HDMI Mode]** - (HDMI only) User can select Auto/graphic/Video mode. Description as following:

- Auto: Automatic to get device information, device will indicate sending timing is video timing or graphic timing (PC timing).
- Graphic: Force video timing shows as graphic timing, for example: 720p shows 1280x720@60Hz; 1080i shows 1920x1080@60Hz. This mode optimises for PC input.
- Video: Force graphic timing shows as video timing, for example: 1280x720@60Hz shows 720p; 1920x1080@60Hz shows 1080i. This mode optimises for DVD player, camcorder, and other video appliances inputs.

## SOUND MENU

The Sound menu provides audio adjustment for user to modify the audio setting.

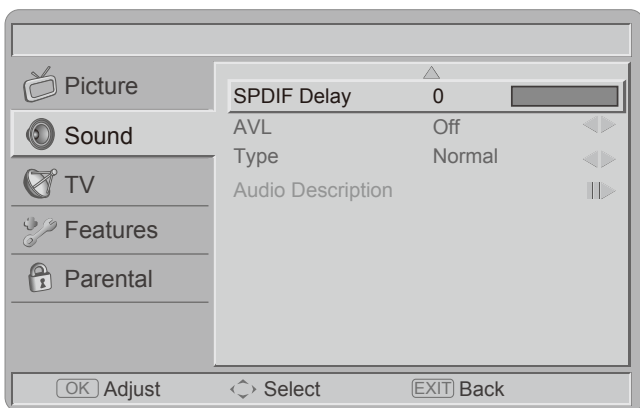
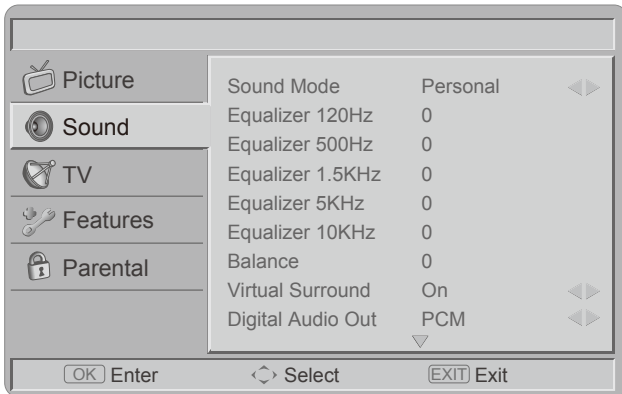

1. **Sound Mode:** To set the TV to a predefined sound setting from Personal, Music, or Speech.
2. **Balance:** To adjust the balance between left and right channels.
3. **Virtual Surround:** To add greater depth and dimension to the TV sound.
4. **Digital Audio Out:** To select the Digital Audio Out from Off or PCM.
5. **SPDIF Delay:** SPDIF Delay function will affect SCART/Line out audio also delay at that time. The NorDig HD IRD shall support the possibility to adjust the audio-delay on the SPDIF output (if available) up to 250 ms and it should be adjustable in 10ms steps, as the IRD may have several different user set-ups, resulting in different a/v delays; e.g. the IRD may be connected to several types of external audio-amplifiers and the STB may be connected to several types of external screens.

6. **AVL:** Choose On or Off to adjust volume to be consistent across programmes and channels automatically.

The following functions are only available for digital channels with audio signals.

7. **Type:** This function enables you to choose the type of the additional narration during the TV watching from Normal, Hard of Hearing, or Audio Description.

**Hard of Hearing:** This function provides narration to deaf and hard of hearing viewers.

8. **Audio description:** When the Type is set to "Audio Description", you can adjust the volume of the audio description.

## TV MENU

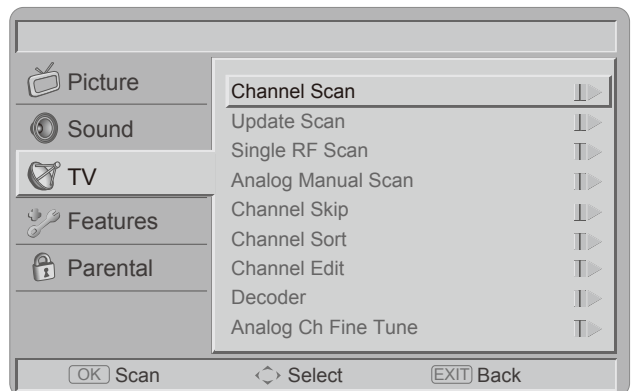
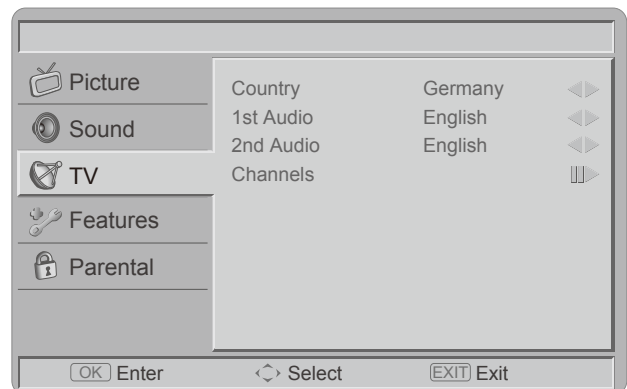

1. **Country:** To select the relevant country. This is the country you are in, or the country whose channels you want to receive if you live near its borders.
2. **Audio Carrier (ATV only):** Select Stereo, Dual 1, Dual 2, or Mono for ATV channel.

- 1st and 2nd Audio:** Use this function when two or more audio languages are broadcast. This is the language to be used for digital channels if it is available.
- Channels:** Enter the channels submenu, and choose from Channel Scan, Update Scan, Single RF Scan, Analog Manual Scan, Channel Skip, Channel Sort, Channel Edit, Decoder, and Analog CH Fine Tune.

**[Channel scan]** - Channel Scan will re-tune the television automatically. It is recommended to run the Channel Scan periodically to ensure that all new services are added.

**[Update scan]** - Search the new channels automatically that are not in the channel list.

**[Single RF Scan (Digital Only)]** - Enter the Single RF Scan in the Channels submenu to scan digital channels.

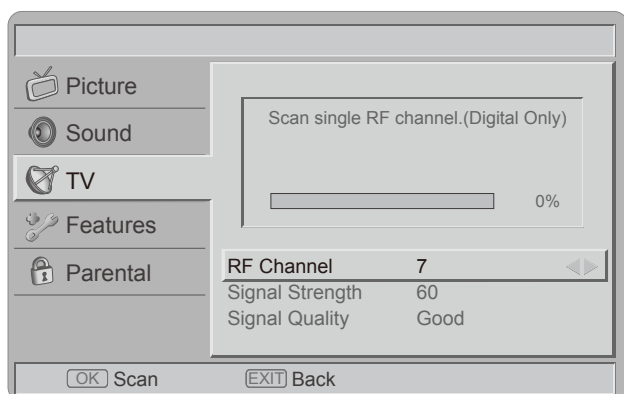

**[Analog Manual Scan]** - The television can be tuned-in manually using Analog Manual Scan. Use the number keys to enter the Start Frequency to scan up or scan down.

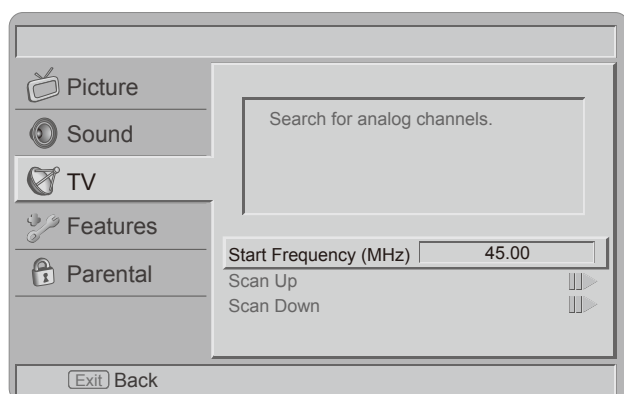

**[Channel skip]** - To prevent certain programs from being viewed by pressing CH + / - buttons on the remote control, the program position can be skipped.

**Tip:** The skipped program may not be found by pressing CH + / - buttons but can be access by pressing number buttons directly.

**Tip:** The skipped program may not be found by pressing CH  $\wedge$  /  $\vee$  but can be accessed by pressing number buttons directly.

**[Channel sort]** - Change the order of the Channel List.

**[Channel Edit]** - Enter the Channel Edit in the channels submenu to edit the channel number and channel name by using the number buttons 0~9.

**Note:** The following RC number-mapping table will not be shown on the TV screen.

RC	Available characters
0	. @ 0
1	_ - 1
2	A B C a b c 2
3	D E F d e f 3
4	G H I g H i 4
5	J K L j k l 5
6	M N O m n o 6
7	P Q R S p q r s 7
8	T U V t u v 8
9	W X Y Z w x y z 9

**[Decoder (Analog only)]** - Channel Decode support the Canal+ (paid television channel); however, the channel also broadcast some un-encrypted programs. These programs without encryption can be viewed free of charge.

**[Analog CH Fine Tune]** - Select Analog CH Fine Tune in the Channels submenu to adjust the frequency.

## FEATURES MENU

The Features menu in TV mode shows as below. This menu gives users the most flexibilities to satisfy their generally demands. According to the various requirements in different source modes, certain features should be hidden (disable) on the menu. The details footnotes will be described clearly below.

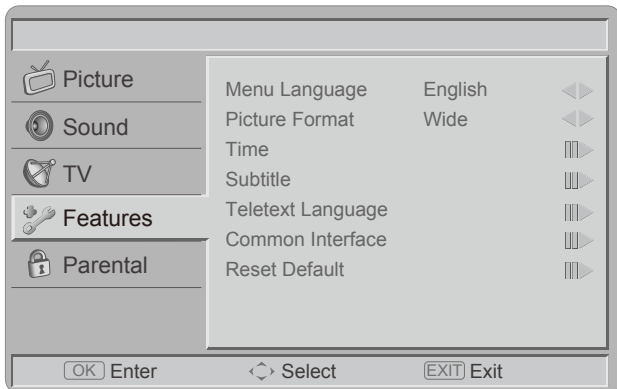

1. **Menu Language:** To select the on-screen display menu language.
2. **Picture Format:** To select the available display format from Auto, Normal, Native (HDMI only), Zoom 1, Zoom2, or Wide.
3. **Time:**

**[Time Zone]** - To select the time zone you are in.

**[Time]** - To set the time and date or select auto synchronization.

Tip: Before you want to set the time and date by your own, please make sure Auto synchronization is Off.

**[Sleep Timer]** - To set the TV to turn itself off within a certain time.

4. **Subtitle:**

**[Analog Subtitle]** - To display the transmitted subtitle on the screen. Either this text can be permanently displayed (assuming that the service is available in the broadcast) or only when mute is active.

**[Digital Subtitle]** - Use the Digital Subtitle function when two or more subtitle languages are broadcasted. If subtitle data in a selected language is not broadcasted, the default language subtitle will be displayed.

**[Subtitle Type]** - To choose the subtitle type from normal or hearing impaired.

5. **Teletext Language:**

**[Digital Teletext Language]** - To select the teletext language.

**[Decode Page Language]** - To set the

- teletext language to the regional location.
6. **Common Interface:** This menu appears with your CI supplier information.
  7. **HDMI Scan Info (HDMI only):**
    - [Automatic]** - Set to underscan or overscan automatically when the video signal is detected.
    - [Underscan]** - When the video signal is detected, all active pixels and lines are displayed with or without border.
    - [Overscan]** - When the video signal is detected, some active pixels and lines at the edges are not displayed.
  8. **Reset Default:** To reset all TV settings to the original factory values.

## PARENTAL MENU

Enable you to control special functions for the TV channels.

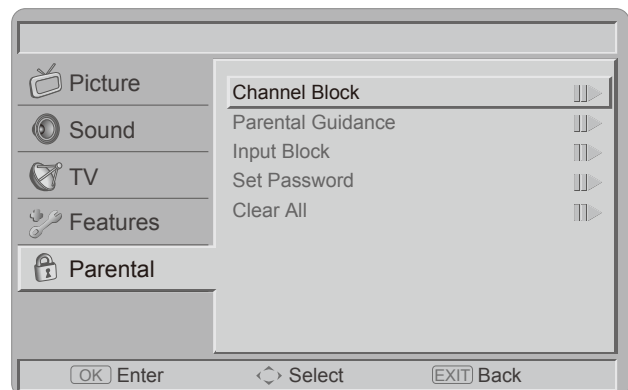

1. **Channel Block:** To block certain TV channels.
2. **Parental Guidance:** To control access programs based on their age ratings. All settings apply to digital channels.
 

Note: This function operates according to information from the broadcasting station. Therefore if the signal has no information, this function does not operate.
3. **Input Block:** To disable the specific external input signals.
4. **Set Password:** To set or change your password. Please follow the instructions to set it. All number combinations from 0000 to 9999 are valid.



Tip: Remember that 5351 is the default Change Password code. If your access code has been changed or you have forgotten the code, you can always get in by inputting the default code.

5. **Clear All:** To clear all the settings in the parental submenu.

## COMMON INTERFACE MODULE

- The Common Interface CI Slot, is designed to accept the Conditional Access CA Module coupled with a Smart card, in order to view pay TV programmes and additional services. Contact your Common Interface service provider for further information about modules and subscription options. Please note that CA modules and smart cards are not included, or supplied as optional extras by us.

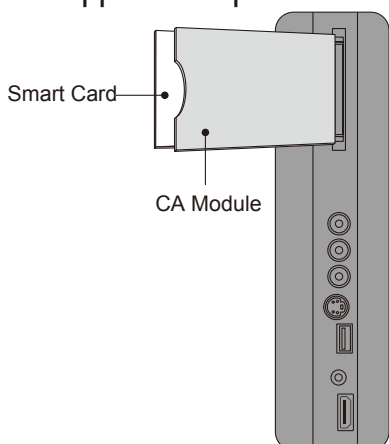

**WARNING:** Switch off your TV before any module is inserted into the Common Interface slot.

1. Correctly insert the CA Module and then the Smart Card into the CI slot located at the side of the TV.
2. Turn on the TV and press MENU and select the TV submenu.

“Common interface” will be displayed if the CA module is detected. Wait for few moments until the card is activated.

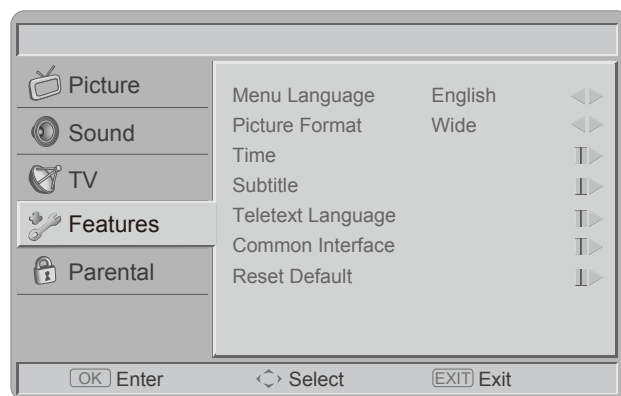

3. Select Common Interface to view the menu options and information on the inserted CI card.

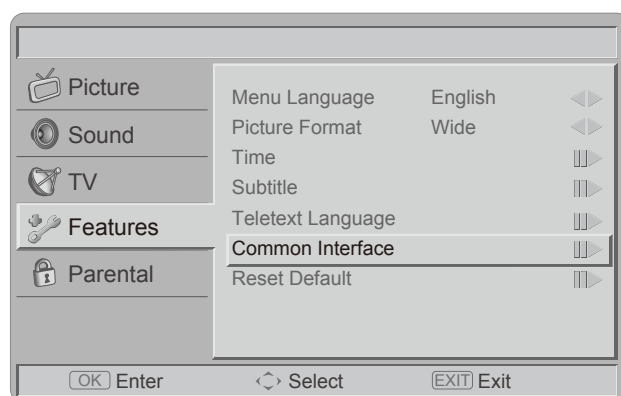

4. Press OK to access the card menu, for more details refer to the module's instruction manual.

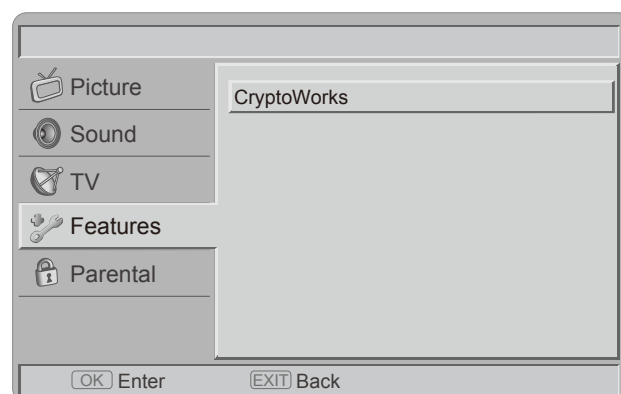
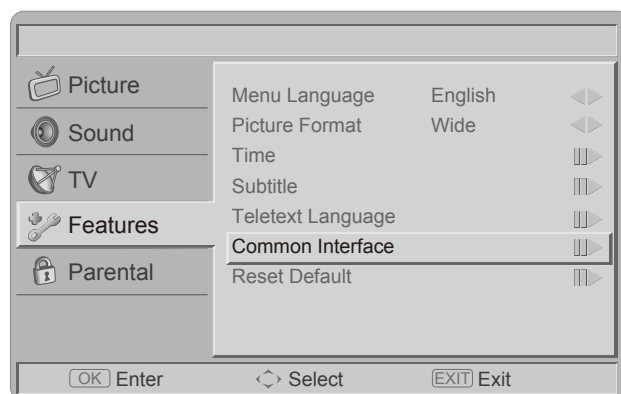

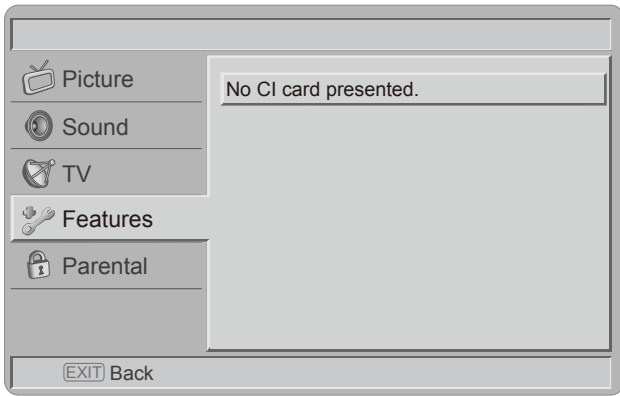

- When module is removed, the “Common Interface” menu will disappear from the screen.

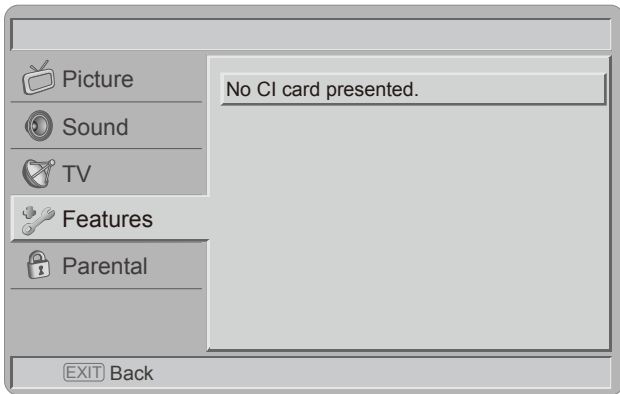

## OAD OPERATION

### OAD for Software Update function:

- When you get the updating news from the TV shop's web, you can update the operation software using the Download menu. The data for various units are transferred consecutively on a special receiving channel.
- you need to search the channel with updating code stream. (Note: you can get information from the TV shop or internet.)

### Operation

- When you search the channel. You will get a information.

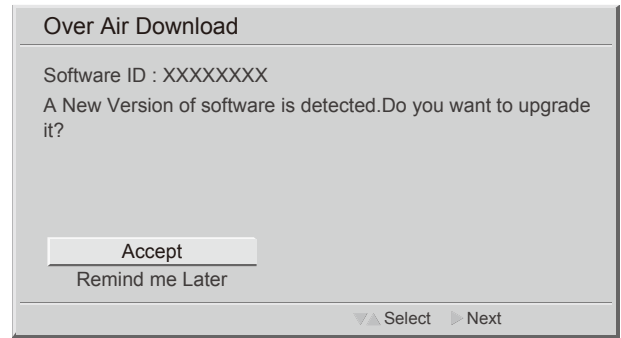

- Press ▲ ▼ to confirm if you would like to “Accept” this new software or “Reject” and use ► button to action update new software.

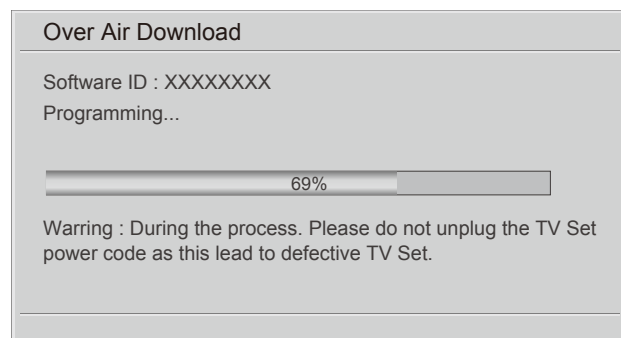
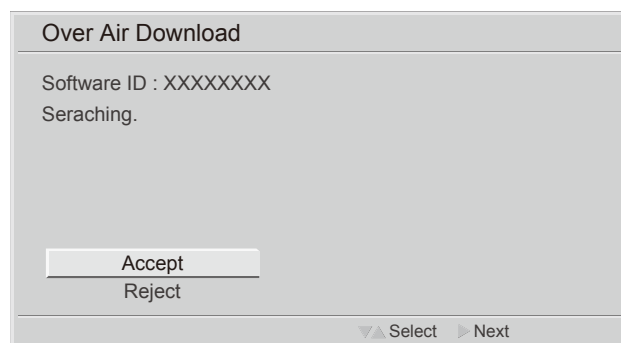
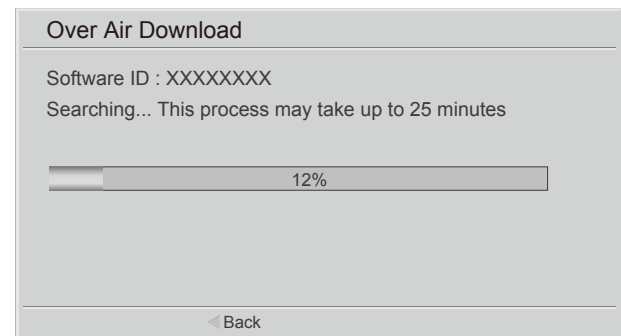
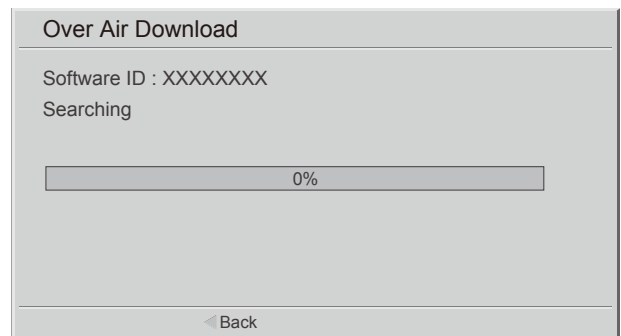

3. After the programming , please use ▲ ▼ to confirm if you would like to restart the TV. The software will be updated completely after restart the TV.

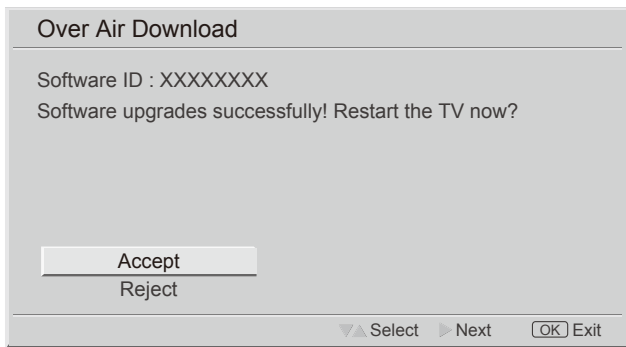

**NOTE:** You must not switch off the unit during this process!

## TIPS

### Care of the screen

Do not rub or strike the screen with anything hard as this may scratch, mar, or damage the screen permanently.

Unplug the power cord before cleaning the screen. Dust the TV by wiping the screen and the cabinet with a soft, clean cloth. If the screen requires additional cleaning, use a clean, damp cloth. Do not use liquid cleaners or aerosol cleaners.

### Mobile telephone warning

To avoid disturbances in picture and sound, malfunctioning of your TV or even damage to the TV, keep away your mobile telephone from the TV.

### End of life directives

We are paying a lot of attention to produce environmental friendly in green focal areas. Your new receiver contains materials, which can be recycled and reused.

At the end of its life, specialized companies can dismantle the discarded receiver to concentrate the reusable materials and to minimize the amount of materials to be disposed of.

Please ensure you dispose of your old receiver according to local regulations.

# PRODUCT SPECIFICATION

## NOTE

- \* This model complies with the specifications listed below.
- \* Designs and specifications are subject to change without notice.
- \* These models may not be compatible with features and/or specifications that may be added in the future.

Model No.	LT19A1	LT22A1	LT26A1	LT32A1	LT42A1
<b>DISPLAY</b>					
Viewable	18.5"	22"	26"	32"	42"
Television System	PAL, SECAM standard, DVB-T standard				
<b>CONNECTIONS</b>					
Rear Connectors	<b>Tuner input (75Ω)</b> <b>PC IN:</b> D-SUB and PC Audio (Headphone mini-jack) Recommended:1360x768/60Hz  <b>Component Video and L/R Audio input</b> Supported resolution: 480i, 576i/p, 720p, 1080i, 1080p(42" only)  <b>HDMI input</b> Supported scan rates: 480p, 480i, 576p, 576i, 720p, 1080i, 1080p(42" only)				
	SCART 1 SPDIF HDMI 1	SCART 1 SPDIF HDMI 1	SCART 1 SCART 2 SPDIF HDMI 1 HDMI 2	SCART 1 SCART 2 SPDIF HDMI 1 HDMI 2	SCART 1 SCART 2 SPDIF HDMI 1 HDMI 2 HDMI 3
	SCART 1: RGB + CVBS in/out + audio in/out SCART 2: S-Video + CVBS in/out + audio in/out				
	<b>COMMON INTERFACE</b> AV In (Composite Audio/Video) Earphone Output				
Side Connectors					
<b>WEIGHT &amp; DIMENSION</b>					
Dimensions with Stand (W x H x D)	455x145x388 mm	528x382x175.8 mm	657.2x489.3x219.0 mm	789.5x569.1x239.5 mm	1015.4x703.0x280.5 mm
Weight with Stand	3.7kg	4.8kg	8.0kg	11.1kg	20.5kg
Weight without Stand and Base	3.45kg	4.55kg	6.8kg	9.3kg	17.6kg

<b>WALL MOUNTING</b>					
VESA-compatible wall bracket (W x H)	100x100 mm	100x100 mm	200x100 mm	200x200 mm	400x200 mm
Screw type	Metric 4x10 mm	Metric 4x10 mm	Metric 4x10 mm	Metric 6x10 mm	Metric 6x10 mm
<b>POWER</b>					
Power Consumption	50W	55W	120W	130W	200W
Standby	< 1W				
Mains Power	AC100-240V~, 50/60Hz	AC100-240V~, 50/60Hz	AC220-240V~, 50/60Hz	AC220-240V~, 50/60Hz	AC220-240V~, 50/60Hz
Audio Power	3W + 3W	3W + 3W	5W + 5W	5W + 5W	10W + 10W
Ambient Temperature	5°C - 35°C				
<b>PACKAGE CONTENTS</b>					
Supplied Accessories	TV unit x1 Power cord x 1 Remote control x1 (with two size AAA alkaline batteries) User manual x1 Setup Guide x1				

## BEFORE CALLING SERVICE

Please make these simple checks before calling service. These tips may save you time and money since charges for receiver installation and adjustments of customer controls are not covered under your warranty.

Symptoms	Items to Check and Actions to follow
“Ghost ” or double image	*This may be caused by obstruction to the antenna due to high rise buildings or hills. Using a highly directional antenna may improve the picture.
No power	*Check if the TV’s AC power cord is plugged into the mains socket. *Unplug the TV, wait for 60 seconds. Then reinsert plug into the mains socket and turn on the TV again.
No picture	*Check antenna connections at the rear of the TV to see if it is properly connected to the TV. *Possible broadcast station trouble. Try another channel. *Adjust the contrast and brightness settings. *Check the Closed Captions control. Some TEXT modes could block the screen,
Good picture but no sound	*Increase the VOLUME. *Check if the TV is muted; press the MUTE button on the remote control.
Good sound but poor colour	*Adjust the contrast, colour and brightness settings.
Poor picture	*Poor picture quality may occur when an activated S-VHS camera or camcorder is connected to your TV and the other peripheral at the same time. Switch off one of the peripherals.
Snowy picture and noise	*Check the antenna connection
Horizontal dotted line	*This may be caused by electrical interference (e.g. hairdryer, nearby neon lights, etc.) *Turn off the equipment.
Television not responding to remote control	*Check whether the batteries are working. Replace if necessary *Clean the remote control sensor lens on the TV. *You can still use the buttons at the front of your TV. *Select the TV mode to ensure your remote control is set in the TV mode.

## **GLOSSARY**

---

### **HDTV**

HDTV displays are technically defined as being capable of displaying a minimum of 720p or 1080i active scan lines.

### **HDMI Inputs**

High-Definition Multimedia Interface

### **Audio / Video Inputs**

Located on the rear of the receiver, these connectors (RCA phono type plug) are used for the input of audio and video signals. Designed for use with VCRs (or other accessories) in order to receive higher picture resolution and offer sound connection options.

### **Menu**

An on-screen listing of features shown on the TV screen is made available for user adjustments.

### **RF**

Radio Frequency or modulated signal design used as the carrier for television broadcasts.

### **Sleep Timer**

You can set a time period for which the TV will be turn off automatically.

# APPENDIX

## Appendix 1

### VGA Timing table

Item	H.Freq.(KHz)	Mode	Resolution	V.Freq.(KHz)	19"~32"	42"
1	31.469	IBM VGA	640x350	70.086		
2	31.469	IBM VGA	720x400	70.087	•	
3	31.469	IBM VGA	640x480	59.94	•	•
4	35	MACINTOSH	640x480	67		
5	37.861	VESA	640x480	72.809		
6	37.5	VESA	640x480	75		
7	35.156	VESA	800x600	56.25		•
8	37.879	VESA	800x600	60.317	•	•
9	48.077	VESA	800x600	72.188		
10	46.875	VESA	800x600	75		
11	49.7	MACINTOSH	832x624	75		
12	48.363	VESA	1024x768	60.004	•	•
13	56.476	VESA	1024x768	70.069		
14	60.023	VESA	1024x768	75.029		
15	61.08	IBM XGA-2	1024x768	75.781		
16	44.772	VESA CVT	1280x720	59.855		•
17	47.776	VESA	1280x768	59.87		•
18	60.289	VESA	1280x768	75		
	49.702	VESA	1280x800	59.81		•
19	47.72	VESA CVT	1360x768	59.799	•	•
20	63.981	VESA	1280x1024	60.02		•
21	79.976	VESA	1280x1024	75.025		
	55.935	VESA	1440x900	59.887		•
	70.635	VESA	1440x900	74.984		
22	65.29	CVT1.76MW	1680x1050	59.954		•
23	64.674	CVT1.76MW-R	1680x1050	59.883		•
24	66.587	CVT2.3MA-R	1920x1080	60		•



## Appendix 2

### HDMI (High Definition Multimedia Interface) support format

1. Support 480i/480p, 576i/576p, 720p, 1080i, 1080p(42" only) format with HDCP.
2. Digital interface with 4 channels TMDS signal.

### Scart input/output description

TV Source	Screen Display Source	SCART1 Out	SCART2 Out
ATV	ATV	ATV	ATV
	CVBS	CVBS	CVBS
	HDMI /VGA / Component	-- / -- / Component	-- / -- / Component
DTV	DTV	DTV	TV
	CVBS	CVBS	CVBS
	HDMI /VGA / Component	-- / -- / Component	-- / -- / Component

# INFORMATION

## Connecting to Power

Check that the voltage marked on the product corresponds with your supply voltage. This product is fitted with a 16A plug (Or 10A Plug). If this plug is unsuitable or needs to be replaced, please note the following :

## Plug Replacement

If you need to replace the fitted plug.



### WARNING :

Never connect live or neutral wires to the earth terminal of the plug. Only fit an approved 16A plug . If in doubt, consult a qualified electrician.

## IMPORTANT

The wires in this mains lead are coloured as follows:

Blue-Neutral

Brown-Live

As the colours of the wires in the mains lead of this apparatus may not correspond with the coloured markings identifying the terminals in your plug, proceed as follows:

The wire which is coloured blue must be connected to the terminal which is marked with N or coloured blue. The wire which is coloured brown must be connected to the terminal which is marked L or coloured brown. Always ensure that the plug cord grip is fastened correctly.

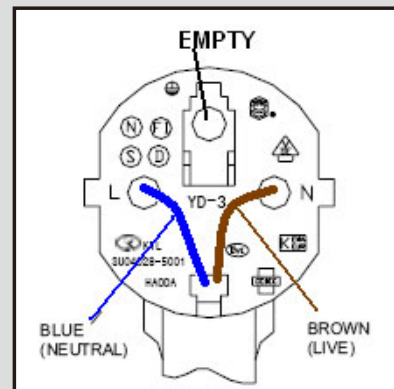

## CE marking



The shipped version of this device complies with the requirements of EEC directives 2004/108/EC "Electromagnetic compatibility" and 2006/95/EC "Low voltage directive"  
WASTE ELECTRICAL PRODUCTS SHOULD NOT BE DISPOSED OF WITH HOUSEHOLD WASTE. PLEASE RECYCLE WHERE FACILITIES EXIST. CHECK WITH YOUR LOCAL AUTHORITY FOR RECYCLING ADVICE.

Haier Europe Trading S.R.L.  
Via De Cristoforis,12-I 21100 Varese,Italy







# Haier



Q41G19MV672 1A

## Free Manuals Download Website

<http://myh66.com>

<http://usermanuals.us>

<http://www.somanuals.com>

<http://www.4manuals.cc>

<http://www.manual-lib.com>

<http://www.404manual.com>

<http://www.luxmanual.com>

<http://aubethermostatmanual.com>

Golf course search by state

<http://golfingnear.com>

Email search by domain

<http://emailbydomain.com>

Auto manuals search

<http://auto.somanuals.com>

TV manuals search

<http://tv.somanuals.com>