

# Haier Trouble-shooting

If the laundries fall to the outer side of the spin tub

If the laundries fall to the outer side of the spin tub, Please contact the after-sales service department.

(If there's breakdown, please pull off the power plug before checking) The following phenomena are not breakdowns sometimes. Please confirm again before sending it to repair. If there are real breakdowns, please come to the special maintenance department or after-sale service department of our company. Do not repair it by yourself.

Phenomena	The reason	How to settle
The machine does not function.	<ul style="list-style-type: none"> <li>Is there power failure?</li> <li>Is the power plug loose?</li> <li>Is the pulsator twisted by foreign materials?</li> </ul>	<ul style="list-style-type: none"> <li>Use it when the power is on.</li> <li>Insert the power plug tightly.</li> <li>Remove the foreign materials.</li> </ul>
The draining does not function	<ul style="list-style-type: none"> <li>Has the drain hose being laid down?</li> <li>Is the drain hose blocked by foreign material?</li> <li>Are there any laundries trapped at the outer side of the spin tub?</li> </ul>	<ul style="list-style-type: none"> <li>Put down the drain hose.</li> <li>Remove the foreign material.</li> <li>Please contact the after-sales service department.</li> </ul>
There's abnormal sound during washing	<ul style="list-style-type: none"> <li>Are there hair pin, coins or metal items brought inside the tub?</li> </ul>	<ul style="list-style-type: none"> <li>Remove the hair pin, coins or metal items.</li> </ul>
There's abnormal sound and violent vibration during spinning	<ul style="list-style-type: none"> <li>Is the machine slanting?</li> <li>Is the gland pressed evenly?</li> <li>Are there any laundries trapped at the outer side of the spin tub?</li> <li>Are the laundries in spin tub over loaded?</li> </ul>	<ul style="list-style-type: none"> <li>Pressed the gland evenly.</li> <li>Level the machine properly.</li> <li>Remove the laundries.</li> <li>Remove a little laundries.</li> </ul>

# Haier

TWIN-TUB WASHING MACHINE  
AWT-120LI

## USER

## Manual

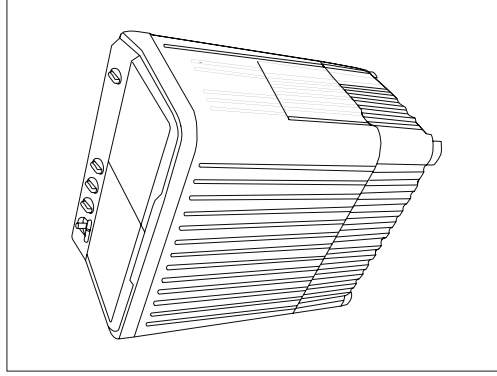

### WASHING MACHINE



### CONTENTS

- Packing list
- Specification
- Names of the parts
- Safety precautions
- Installation and adjustment
- Preparation before washing
- Do's and don'ts
- Usage of the detergent
- Washing sequence
- Maintenance
- Trouble-Shooting

## Packing list

Name	Quantity
● User's manual	● One piece
● Water inlet hose 	● One piece
● Gland 	● One piece
● Semi Auto washing machine	● One set

## Specification

Rated voltage · frequency	220V ~ · 50Hz
Water level / Water quantity (estimated) (L)	Maximum/89 Medium/75 Minimum/63
Washing capacity(kg)	12.0
Spinning capacity(kg)	6.0
Injection pressure(MPa)	0.02~0.2

★ Specifications may be subject to change without prior notice

## Cleaning the overflow filter

2. Take off the corrugation pipe.  
Dismantle the upper part of the corrugation pipe inside the overflow filter (as indicated in Figure 1).

3. Cleaning the overflow filter.  
Clean the lint around the filter and flush with tap water.

4. Install the overflow filter.  
(1).Install the corrugation pipe.  
(2).Insert the mounting plate at the bottom of the filter into the valve cover.  
(3).Hang up the hook at the left upper side.  
(4).Push the upper part in as indicated in Figure 2.

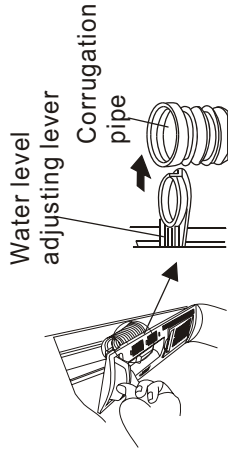

Figure 1

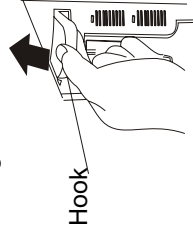
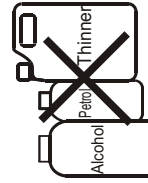

Figure 2

## Disposal of the complete unit

- Wipe the complete unit with soft cloth twisted dry.
- Wipe with neutral detergent if too dirty
- Do not wash it directly by water



- After washing, dismount the water inlet hose.
- Do not store water in the tub for long period. Discharge the water immediately after each using.
- Pull off the power plug and hang up the power cord.
- Hang up the drain hose.  
Wipe off the water drops on the surface and inside the tub with clean soft cloth.
- Open the cover of the wash tub and the inner/outer cover of the spin tub for some time (about one hour), then close them.

# Haier Maintenance

- After using, please clean the lint and eyewinker of the lint filter and overflow filter in time. Otherwise it may influence your using the machine.
- Please first pull off the power plug from the receptacle before cleaning.

## Cleaning the lint filter

- The lint filter must be used during washing.
- It must be cleaned in time after each using.

1. Press the elastic piece at upper end of lint filter to release the tab from the filter cover, and pull the lint filter outward to remove it. (See Figure 1).

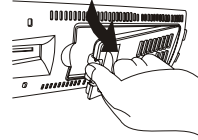
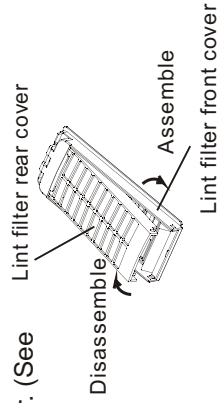

Figure 1

2. Remove lint

Pull the lower end of lint filter rear cover outward to disassemble it from the lint filter front cover.

Remove lint completely with clear water. (See Figure 2).



3. Install lint filter

Figure 2

## Cleaning the overflow filter

- Too much lint on the overflow filter will influence the normal usage of the machine. Please clean it every two months.

1. Take off the overflow filter.

As indicated in the figure, nip the elastic fixing claw and pull it to the direction of the arrow to take it off.

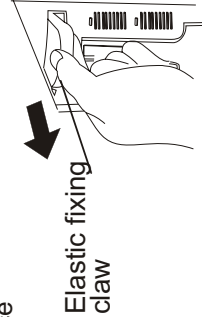

# Haier Names of the parts

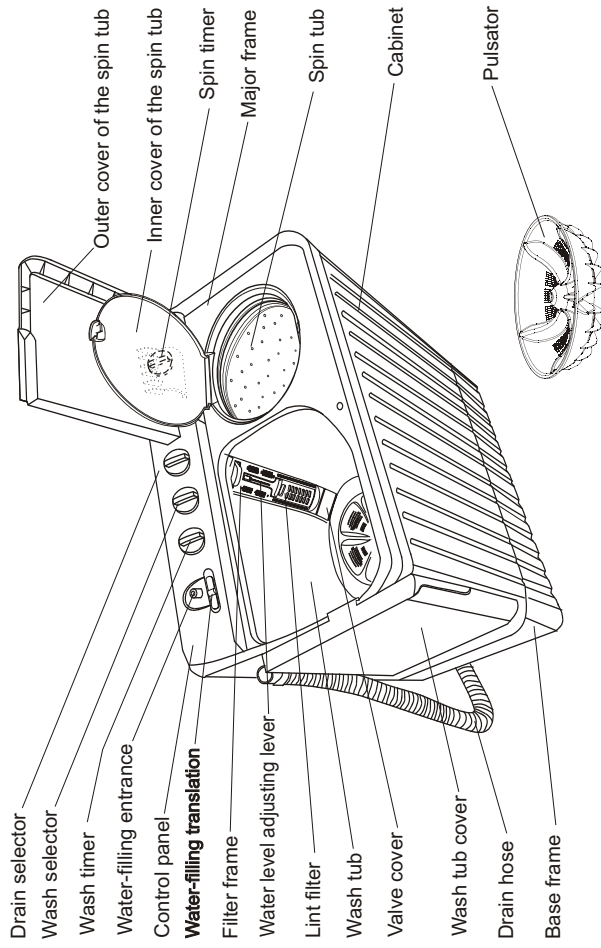

Notes: All illustrations in this manual are given for reference only. Your products and accessories may show differences from these illustrations due to our continuous improvement.

## Meaning and description of the symbols

<p>Warning sign</p>	<p>Contents marked with that symbol are related to the safety of the product and the personal safety of the users. Please operate in strict conformity to the contents, otherwise it may cause damage of the machine or injure the personal safety of the user.</p>
<p>Forbidding sign</p>	<p>Contents marked with that symbol are actions forbidden to perform. Performing of those actions may result in damage of the machine or injure the personal safety of the user.</p>

Please check if the power receptacle has good earthing condition before using to guarantee your safety.

Please insert the power cord into special receptacle with rated voltage. Be sure to use single-phase three pins receptacle. The earthing terminal of the receptacle must be earthed reliably. If possible, please adopt electric leakage protector.

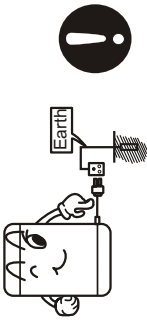

When the machine is normally using, please put the power plug at the location easily to be inserted and extracted by hand. Be sure to pull the plug off when there's power failure, or the machine is being moved, cleaned or when it is idle.



If the supply cord is damaged, it must be replaced by the manufacturer or its service agent or a similarly qualified person in order to avoid a hazard.



Do not put the machine at damp place like the bathroom. Never wash it with water. Do not place wet laundries on the control panel.

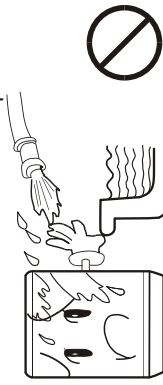

Do not use water hotter than 50°C.

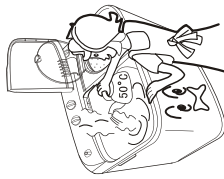

For washing machine with ventilation openings in the base, that a carpet must not obstruct the openings.

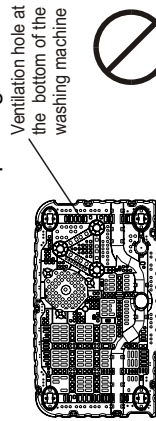

Ventilation hole at the bottom of the washing machine

Do not wash water-proof laundries like the raincoat, bike covers etc. to avoid abnormal vibrations.



Do not let the machine share one receptacle with other electric appliances. If the power plug is damaged, or the plugging into the receptacle is loose, do not use the plug any more.

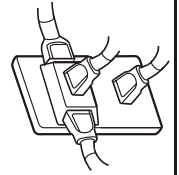

## Spinning

1. Put the laundries into the spin tub evenly and smoothly.
2. Press the gland in the tub properly. Close the inner and outer cover of the spin tub.
3. Spin
  - Select suitable spin time according to the laundries, and do spinning.
  - During spinning, if there is abnormal sound, it is generally owing to slanting placement of the laundries. Please stop the machine and reorder the laundries.
  - In spinning, it will pause the work if you open the outer cover of the spin tub. Close it to resume the spinning.

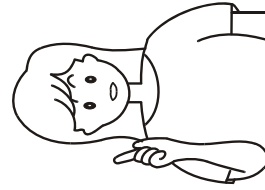

To do spinning and draining and rinse with water-filling together, please first do spinning for around 1 minute, then do draining or rinse with water-filling. Otherwise the spinning will stop owing to too much water stored in the spin tub.

## Rinsing

### Rinse with water-filling

1. Put the laundries into the wash tub. Select suitable current according to the laundries.
2. Adjust the water level  
Set the water level with water level adjusting lever according to the laundries quantity. Then fill suitable water continuously.
3. Rinse  
Adjust the wash timer to 5-7 minutes to do rinsing.

### Rinse with stored water

- (Repeat the midway spinning and rinsing with stored water for 2-3 times)
1. Put the laundries into the wash tub. Select suitable current according to the laundries.
  2. Fill water to preset water level.
  3. Rinse  
Adjust the wash timer to 2-3 minutes to do rinsing.

When the laundries quantity is few, please use "Standard" current. If you use "Strong" current, it may splash.

Do not stretch hands into the working machine. It is dangerous even if the rotation is slow. Take special care of the children.

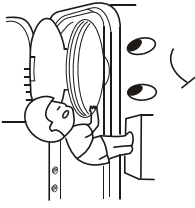

Do not decompose, repair or alter the machine by yourself.

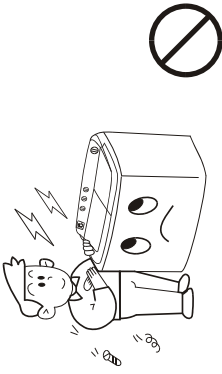

Do not put any hot or heavy items (such as the kettle with hot water) on the washing machine.

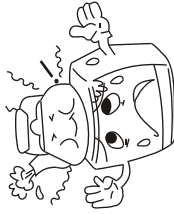

Do not wash laundries with volatile materials (such as thinner, petrol etc.).

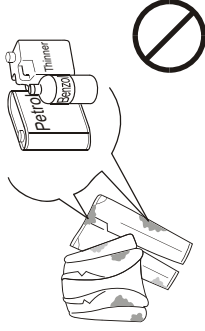

Handicapped or children without care shall not use the machine.

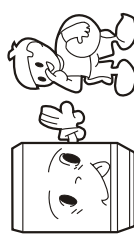

Keep the machine away from direct sunlight and heat source like the heater.

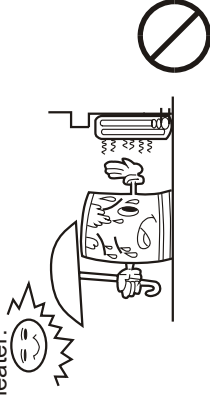

- To protect your laundries and washing machine, please take out all of the coins, buttons, sand, hairpin and other foreign materials before washing.



- Please check if the connection of the water inlet pipe is proper.
- It is suggested to use foamless washing powder.



# Haier Installation and adjustment

Please install and adjust the machine according to the requirement of the manual. It is very important to your security and correct operating the machine.

## Install the lint filter

Put the underside of the lint filter into overflow filter, then push the upside into overflow filter.

- After installation, please refer that the lint filter installed to the right station, otherwise the lint filter may be fallen off when washing, influencing your use.



## Usage of the drain hose

The drainage shall be smooth with the drain hose.

1. The height of the drain hose shall be less than 10cm, or the drainage will not be smooth enough and cause incomplete drainage.
2. Do not tramp or press the drain hose.
3. If the drain hose is too long, cut it at mid point. To make smooth drainage, cut the front end of the hose slantingly.
4. If extra drain hose is needed, please make separate purchase. The inner diameter of the extra hose shall not less than 30mm, and the length shall not exceed 1.5m.

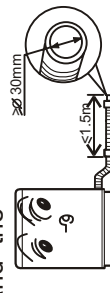
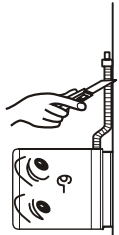
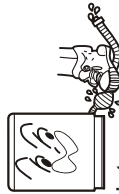
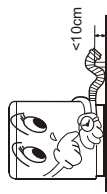

If the extra hose is too long, cut it either at point A or B.

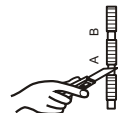

# Haier

## Midway spinning

1. Put the laundries into the spin tub evenly and smoothly.

2. Spin:

(1) Put the gland in properly.

Please put in the gland properly even if the laundries quantity is small.

Push Gland

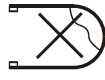
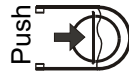
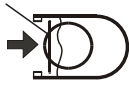

Proper The laundries are slanting

Proper

No gland

(2) Close the inner and outer cover of the spin tub.

(3) Spin for 1-2 minutes.

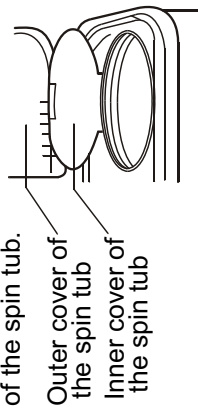

Outer cover of the spin tub  
Inner cover of the spin tub

3. Run the foam-removing spinning.

(1) Set the inlet selector handle on spin side and fill water for about 1 min.

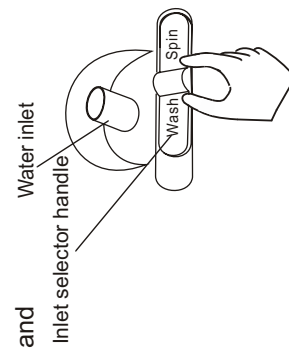

Water inlet  
Inlet selector handle

- In case water flows out from wash tub side due to too much inflow, please turn down the water tap a bit.

(2) Close the spin tub outer cover and spin for about 1 - 2 min.

# Haier Washing sequence

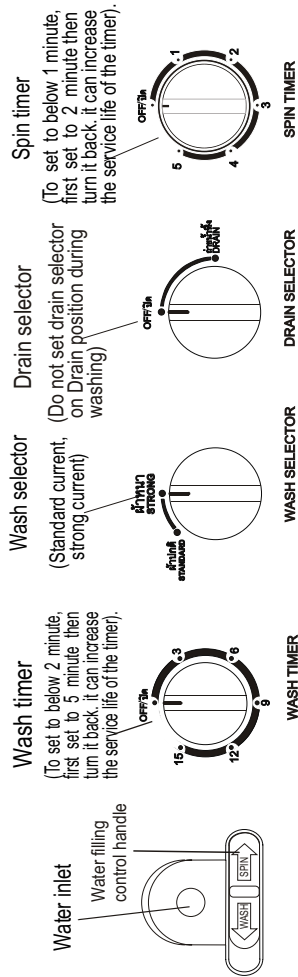

## Wash

- Inlet selector**
  - Set inlet selector to "Wash" side. (Figure 1)
  - Adjust water level rod to a position as needed.
- Fill the water and add the dissolved washing powder to make the water level reach the preset position. (Figure 2)  
Run washing program for some time to stir and dissolve the powder completely.
- Put in the laundries. If the water quantity is insufficient, please add water.
- Select the current.  
Select the strength of the current according to the laundries. (Figure 3)
- Select the washing time  
Select the washing time according to the laundries. (Figure 4)
- After washing, the buzzer will ring. Set the "DRAIN SELECTOR" at "DRAIN". (Figure 5).

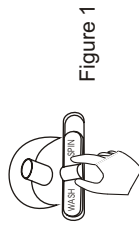

Figure 1

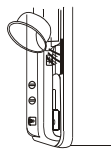

Figure 2

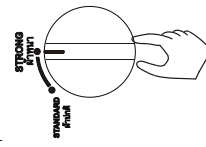

Figure 3

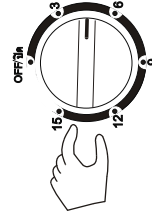

Figure 4

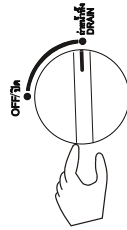
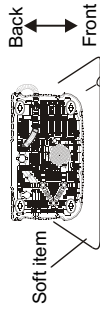

Figure 5

# Haier

How to change the direction of the drain hoses

- Figure 1 indicates the ex factory installation position of the drain hose.



Extend the drain hose from the side of spin tub

- Put soft items on the ground. Lean the machine down gently with the front surface facing the ground. Take off the drain hose from the cabinet. Take the hose out of the fixing groove. (See to Figure 2).

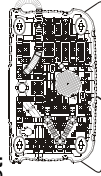

Figure 2

- Embed the drain hose into the groove along the side of the spin tub in the order of (1)-(3), heading for the side of the spin tub. (See to Figure 3).

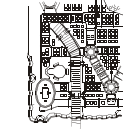

Figure 3

- Embed the drain hose into the groove with hands. Take care not to damage the drain hose in fastening the fixing clamp.

Extend to the spin tub side

## Install the water inlet hose; Select the water level

Insert the water inlet hose into the water-filling entrance on the control panel directly (pull it out to dismantle it)

Select water level according to the quantity of the laundries.

- Set the water level adjusting lever to needed line.

Use the new water inlet hose provided with the machine to connect to the water faucet. Old hose sets should not be reused.

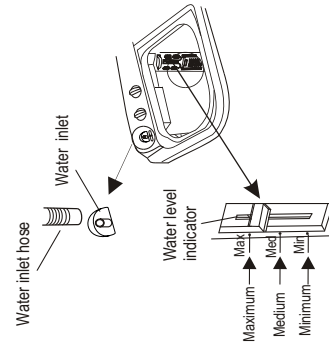

# Haier Preparation before washing

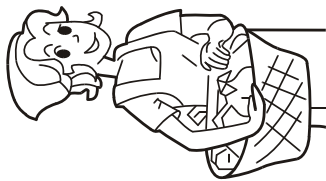

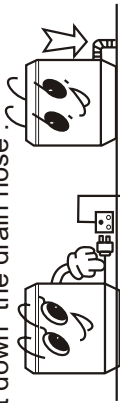

Preparation before washing

1. Connect the water inlet hose.
2. Confirm that the washing machine is earthed reliably. Then insert the power plug into the receptacle. Do not connect the earth terminal to the gas pipe and tap water pipe.
3. Put down the drain hose.



4. Slanting or uneven ground may result in unstable working or abnormal noise. Please make the machine stand horizontally.

Pay attention to following before washing the laundries

Check if the laundries has special requirement on washing	Clear the pocket. Take out the coins, sand, hairpins close zippers, etc.	Tie the long strips; fasten out the buttons; and loosen the laundries before putting them in the tub.	When the pulsator is running, the buttons of the laundries may cause noise. For the sake of discretion, please put the laundries with buttons into other laundries.
			
a. Check if the laundries are applicable for washing with machine.	b. Divide the laundries that are not colorfast from other laundries.	c. Put those laundries difficult to absorb water into water with hand.	d. For those laundries with heavy soil, please first remove the dirt like mud or dust. For the parts with heavy soil, please apply detergent on them in advance, which can make it easier to remove the soil.
e. For those laundries that may get lint ball and those with long fur, tum it over before putting in.	f. Do not put those laundries polluted by chemicals into the washing machine directly.		

# Haier Do's and Don'ts



- The capacity of washing and spinning of the machine refer to the weight of the standard laundries under dry condition that can be washed or spinned in one time.
- The thickness, size, type of the cloth will influence the actual washing capacity. It is suitable to put in reasonable amount of laundries and the laundries can be turned round in washing for one time washing.
- Do not select "Maximum" water level for laundries less than 1.5kg, so as to avoid splashing of water.
- It is suggested not to use high sudsing detergent.

## Usage of the detergent

### How to use the whitener

- Fill water to decided level. Dilute the whitener with container. Pour it slowly into the washing tub.
- Avoid using whitener on laundries with color or pattern as they are prone to lose color.
- The whitener shall not touch the laundries directly.
- Refer to the user's manual for the usage and quantity of the whitener.
- For powder whitener, please dissolve it before using.

### How to use the washing powder

- Direct dissolved in the machine:
  1. Fill small quantity of water.
  2. Add the powder. Run for 30 seconds to dissolve it completely.
  3. Put in laundries. Select suitable water level.
- The instant dissolving of the washing powder:
  1. Prepare warm water of 30°C and a container.
  2. Add the powder while stirring to fully dissolve it.
- The powder is more prone to pollute the laundries than the detergent. Therefore please use it with proper quantity.
- Dosage of different washing powder is different. Please refer to the instruction of the washing powder for the detail dosage.



## Free Manuals Download Website

<http://myh66.com>

<http://usermanuals.us>

<http://www.somanuals.com>

<http://www.4manuals.cc>

<http://www.manual-lib.com>

<http://www.404manual.com>

<http://www.luxmanual.com>

<http://aubethermostatmanual.com>

Golf course search by state

<http://golfingnear.com>

Email search by domain

<http://emailbydomain.com>

Auto manuals search

<http://auto.somanuals.com>

TV manuals search

<http://tv.somanuals.com>