

User's manual

Fully Automatic Washing Machine

Haier

This manual is for
HWM6815

- Please read this manual carefully before using.
- Retain it for future reference.





Contents

Names of the parts.....	1
Safety precautions	2
Installation and adjustment	4
Install the water inlet hose.....	6
Preparation before washing	8
Put in the laundries	9
Usage of the detergent	9
Use the operation buttons	10
Close the top lid	13
Finish washing	13
Disposal after washing	14
Trouble shooting • Answer to question.....	15
Packing list • Specification.....	16

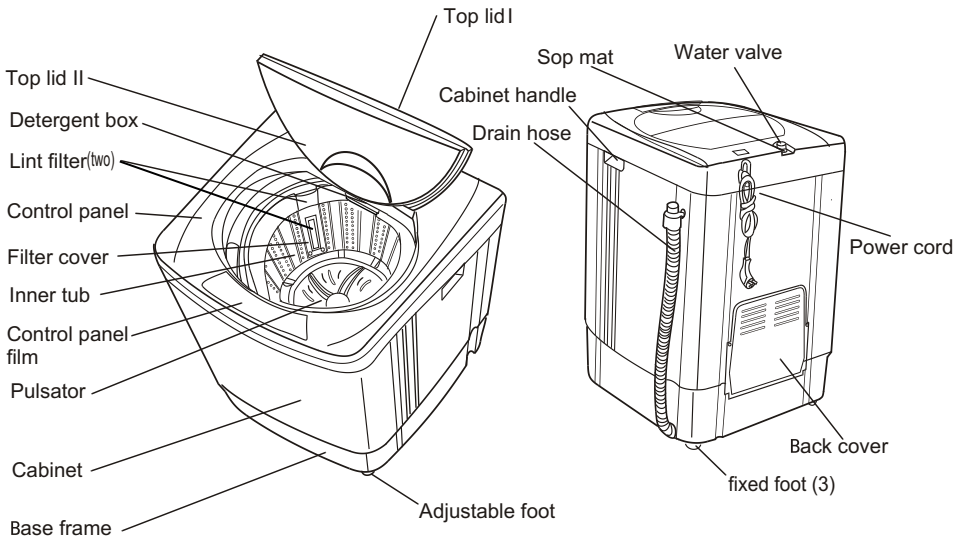
Names of the parts



Meaning and description of the symbols

<p>Warning sign</p> 	<p>Contents marked with that symbol are related to the safety of the product and the personal safety of the users. Please operate in strict conformity to the contents, otherwise it may cause damage of the machine or injure the personal safety of the user.</p>
<p>Forbidden sign</p> 	<p>Contents marked with that symbol are actions forbidden to perform. Performing of those actions may result in damage of the machine or injure the personal safety of the user.</p>

Safety precautions

Please plug the plug on special receptacle with rated voltage. Be sure to use single-phase three pins receptacle. Ensure the earthing prong of the power receptacle is earthed reliably. Use leakage protector if possible.



The power cord plug should be convenient to be plugged in or plugged out with hand while the washing machine runs normally. Be sure to pull the plug out and close the water tap when the machine is idle, when moving the machine, or when cleaning the machine. Do not use wet hand to insert or pull out the power plug.



Do not damage the power cord, bend, extend, twist, bind or alter it by force. Do not press or nip it with weight. If the power cord or the power plug is bad, or the power plug becomes flexible, to avoid risk it is required to have it replaced by the technicians of our special shop or the after-sale service department. Keep the pin of the power plug clean, if the power plug is polluted with dust, please wipe with dry cloth carefully.



Do not put the machine at damp place like the bathroom. Never wash it with water. Not put wet laundries on the control panel.

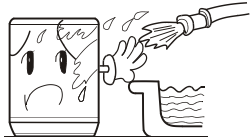

Do not use water hotter above 50°C.



In case the washing machine is installed on ground with carpet, do not block the ventilation hole with carpet.

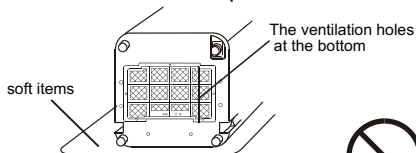

Do not wash water-proof laundries like the raincoat, bike covers etc. to avoid abnormal vibrations in spinning.



Do not let the machine share one receptacle with other electric appliances. If the power plug is damaged, or the plugging into the receptacle is loose, do not use the plug any more.

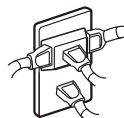

Safety precautions

Do not stretch hands into the working machine. It is dangerous even if the rotation is slow. Take special care of the children. Do not let the children climb the washing machine.



Do not decompose, repair or alter the machine by yourself.

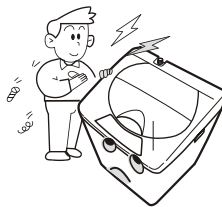

Do not put any hot or heavy items (such as the kettle with hot water) on the washing machine.



Do not wash laundries with volatile materials (such as thinner, petrol etc.)

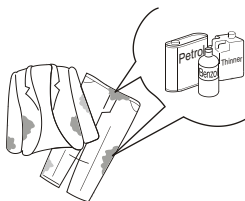

The handicapped or children without care shall not use the machine.

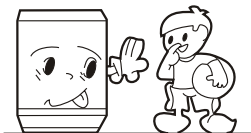

Keep the machine away from direct sunlight and heat source like the heater.

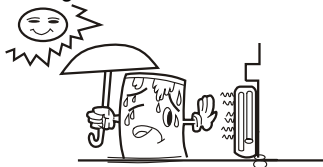

To prevent the lint inside the tub from blocking the cascade outlet during washing, please keep the lint filter in good condition, and install it to proper position. If the lint filter is lost or damaged, please contact the local after-sales service department of our company.

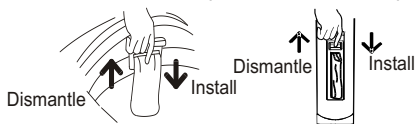

- To protect your laundries and washing machine, please take out all of the coins, buttons, sand, hairpin and other foreign materials before washing.



- Please check if the water faucet is open, and if the connection of the water inlet pipe is proper.

Caution: Do not connect to the hot water supply

- It is suggested to use foamless washing powder.

Installation and adjustment

Please install and adjust the machine according to the requirement of the manual. It is very important to your security and correct operating the machine.

Install the lint filter

Push the lint filter downward to location for lint filter.

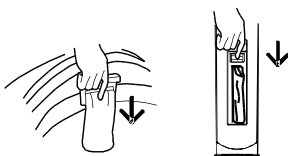

Install the bottom plate

After you open the package, please lean the washing machine gently down on soft items (like the towel cloth, blanket, etc.). Install the bottom plate to the bottom of the machine with the five screws by a cross screwdriver, then lift the machine up gently. See to the figure:

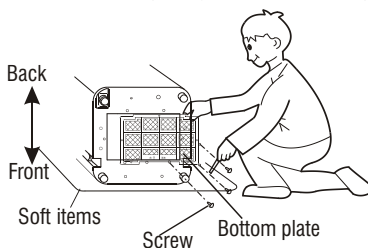

Adjust the installation position

The largest allowed slope of the shank base of the machine is 2° . The slanting or rough ground will result in unstable running or stoppage of the machine. Please adjust it with following methods:

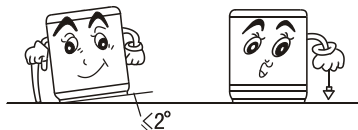

● Adjust the adjustable foot:

1. To twist the adjustable foot, please first lift up the side of the foot slightly, loosen the adjustable nut, and twist the foot.
2. Fasten the nut after adjustment.

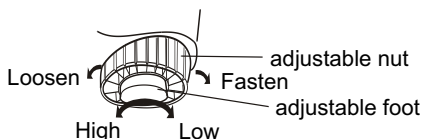

How to change the direction of the drain hose

1. Loosen the fastening screw of the back cover to take off the back cover. Be careful not to do it by force to prevent breaking the claw of the back cover. (as indicated in Figure 1)

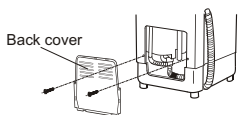

Figure 1

2. Take off the drain hose from the cabinet. Nip the drain hose outlet slightly. Dismantle the drain hose hook. Loosen the fixing screw of the drain hose frame to dismantle the drain hose frame. Pull the drain hose into the cabinet from the left side of the base frame.

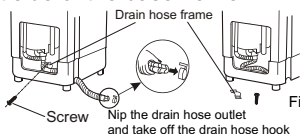

Figure 2

3. Extend the drain hose from the installation hole at the right side of the base frame. Fix the drain hose onto the base frame with the drain hose frame and fasten the screw. Then set the drain hose hook on the drain hose and hang the drain hose on the hanging hole of the cabinet. (As indicated in Figure 3)

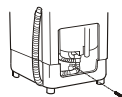

Figure 3

4. To install the back cover, first hang the lower beard of the back cover on the cabinet, then push the claws at the two side and the upper end from bottom to top to resume the original setting. Be careful not to do it by force. Then fasten the screw (two points) (as indicated in Figure 4).

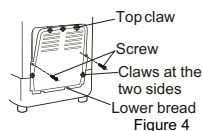
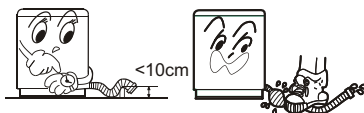

Figure 4

Usage of the drain hose

The drain hose shall drain smoothly

1. The height of the drain hose shall be less than 10cm, or the drainage will not be smooth, and cost such long time that the machine may stop at mid way.
2. Do not trample or press the drain hose.



3. If the drain hose is too long, cut it at mid point. To make smooth drainage, cut the front end of the hose slantingly.



4. If extra drain hose is needed, please make separate purchase. The inner diameter of the extra hose shall not less than 30mm, and the length shall not exceed 1.5m.



5. If the extra hose is too long, cut it either at A or B point.

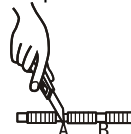

Install the water inlet hose

Confirm the water tap

Water tap, suitable



Water tap, not suitable

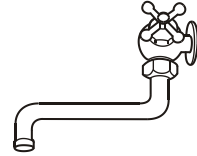

Outlet end surface

>10mm

It is required that the frontend shall be longer than 10mm. The outlet end surface of the tap shall be flat and smooth. If not please file it to avoid leakage.

Connection between the water inlet hose jointer and the water tap

1. Press the lower end of the lock lever and push down the slider. Take off the water inlet hose jointer from the water inlet hose component. See to Figure 1.
2. Loosen the screw till the water tap can be accessed. Put the jointer of the water inlet hose on the tap. See to Figure 2. (If the tap diameter is too large and the jointer can not be set on the water tap, please loosen the four screws and take out the bushing in the jointer. See to the figure 3.)

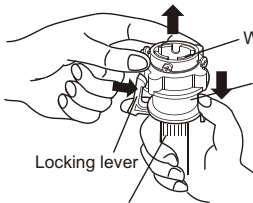

Figure 1

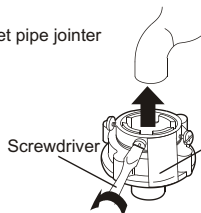

Figure 2

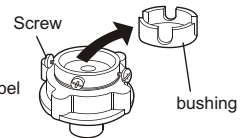

Figure 3

3. Fasten the four screws evenly. See to Figure 4.
4. Take off the nameplate. Twist the fastening nut as per the indication of the figure. See to Figure 5.

Remarks: Before twisting the fastening nut, the thread is 4mm above the upper surface of the nut. After twisting the fastening nut, the thread is 2mm above the upper surface of the nut. See to Figure 6.

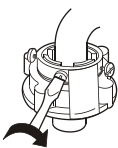

Figure 4

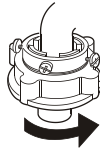
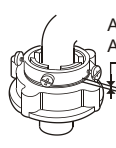

Figure 5



About 4mm before twisting
About below 2mm after twisting

Figure 6

Connection between the water inlet hose and the washing machine

1. Do not take off the water absorption cushion. Please check if the cushion is dropped or damaged before each usage. If it happens please contact our after-sale department immediately.
2. Put the nut of the water inlet hose on the valve jointer.
3. Fasten the nut. Swaying it gently to confirm if it's suitable.

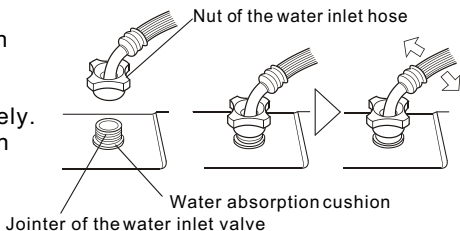

Note : The new hose- set supplied with appliance are to be used and the old hose-sets should not be reuse.

Connection between the jointer of the water inlet hose and the water inlet hose

1. Push down the slider. Insert the water inlet hose into the jointer.
2. Hang the lock lever to the jointer. Release the slider till a click sound is heard.

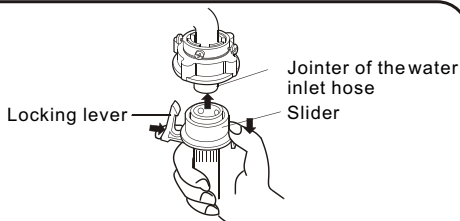

Check the connection between the jointer of the water inlet hose and the water tap

1. Swaying the hose gently to confirm if it is fastened stable.
2. After installation, open the tap to check if it leaks.
3. Do not bend the hose with overstrain.
4. Before each usage please check if the connection between the jointer of the water inlet hose and the water tap, and the installation of the water inlet hose are firm, so as to prevent dropping from improper installation position.

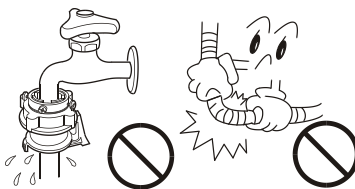

Take down the water inlet hose

1. Close the water tap.
2. Press the locking lever. Push down the slider. Then pull off the water inlet hose. If the machine is used more than once every week, the jointer of the water inlet hose can be kept on the tap to prevent damaging the fixing screw.

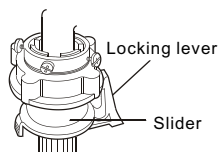

Preparation before washing





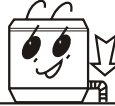

Preparation before washing

1. Connect the water inlet hose and open the water tap .
2. Confirm that the washing machine is earthed reliably . Then insert the power plug into the receptacle. Do not connect the earth terminal to the gas pipe and tap water pipe.
3. Put down the drain hose.



4. Slanting or uneven ground may result in unstable working or abnormal noise. Please make the machine stand horizontally.

Pay attention to followings before washing the laundries

<p>Confirm if there's special requirement for the laundries.</p>	<p>Clear the pocket. Take out the coins , sand, hairpins etc.</p> 	<p>Fasten the buttons and zippers.</p> 	<p>The quantity of the laundries shall not exceed the rated value. The big laundries like the jeans shall be put in loosely.</p> 	<p>When the pulsator is running , the buttons of the laundries may cause noise. For the sake of discretion, please put the laundries with buttons into other laundries.</p> 
--	---	--	--	---

- a. Please check if the laundries are applicable for washing.
- b. Separate those not colorfast from other laundries.
- c. For laundries not water absorbing, please put them into water with hands.
- d. For laundries with much soil, please remove the soil first. You can add detergent on the part with serious soil directly. It is much easier to remove the soil by that mean.
- e. For laundries likely to get lint ball or with long fibre, please first turn the inside out before putting them into the water.
- f. Do not put the laundries polluted with chemicals directly into the washing machine. For those small laundries ,laundries likely to be twisted or worn, and woolen laundries, please put them into mesh bag before washing.

Put in the laundries



- The capacity of washing and spinning of the machine refer to the largest weight of the standard laundries under dry condition that can be washed or spinned in one time. One time washing quantity shall be lower than the rated capacity.
- The thickness, size, type of the cloth will influence the actual washing capacity. It is suitable for one time washing to put in reasonable amount of laundries and the laundries can be turned round in washing.
- To wash thin laundries like the stocking, silk etc., please first put them into washing mesh bag (which can be purchased separately) before wash.

Usage of the detergent

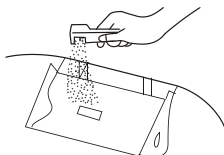

Inlet box of the detergent

How to use the whitener

- Fill water to decided level. Dilute the whitener with container. Pour it slowly into the washing tub.
- Avoid using whitener on laundries with color or pattern as they are prone to lose color.
- The whitener shall not touch the laundries directly.
- Refer to the user's manual for the usage and quantity of the whitener.
- For powder whitener, please dissolve it before use.

How to use the washing powder

- Direct dissolved in the machine
 1. Fill water to "Low" water level.
 2. Add the power. Run for 30 seconds to dissolve it completely.
 3. Put in the laundries. Select suitable water level.
- The instant dissolving of the washing powder:
 1. Prepare warm water of 30°C and a container.
 2. Add the powder while stirring to fully dissolve it.
- Put in the proper quantities detergent according to the water level and the laundries quantities.
- It is suggested not to use high sudsing detergent.
- Washing powder with poor quality or long time storage maybe caked. Please pay attention to cleaning the detergent box in time

Use the operation buttons

a. Description of the function of the buttons

SURPLUS(MIN)

- To indicate "--" during sensing.
- To indicate remaining min. During program running.
- To indicate remaining reserved time (hrs) during reservation period.
- To indicate fault symbols for abnormal conditions (see page 15)

Page 15 

"POWER ON/OFF"button

- Press "Power On/Off" button to connect power supply.
- After power is connected, pressing this button will cut off the supply.

"START/PAUSE"button

- After the power is switched on, press it to start the machine
- During working, push it to pause working.
 - During pause, push this button to restart and continue operation.

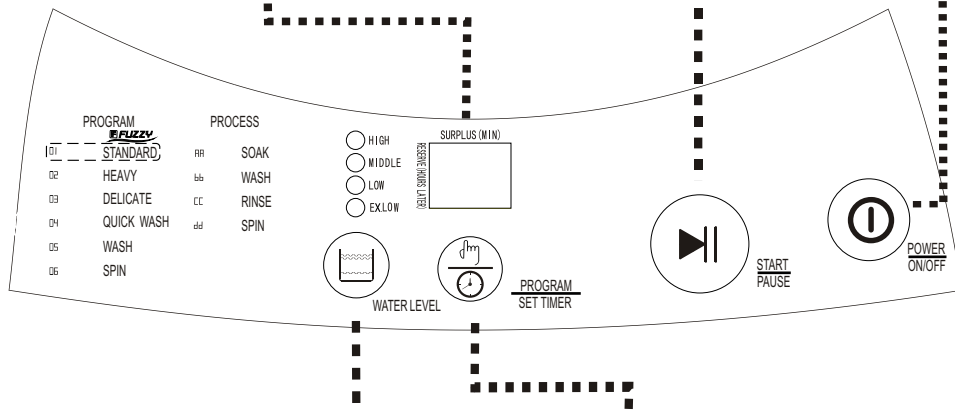

" WATER LEVEL"button

- The user selects a suitable water level depending on the load.

"PROGRAM /SET TIMER " button

- Press "PROGRAM/SET TIMER " button you can select one or several programs of Standard, Heavy, Delicate, Quick Wash, Wash and Spin.
- Press "PROGRAM/SET TIMER " button over 2 seconds, you can select the program of reservation. The nixie tube displays the reserved hours to the wash cycle end. The indicator flashes to indicate in-reservation.

Remarks: 1. After pressing "POWER ON/OFF" to connect power supply, if the washing machine lasts idle more than 5 min, it would automatically shut off the supply.

b. Operating procedure and explanations for the buttons

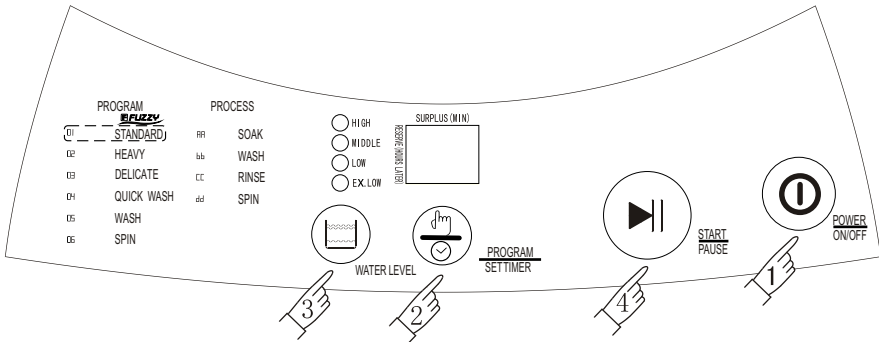

1 Press the "POWER ON/OFF" button to switch on the power supply



2 Press the button of " PROGRAM/SET TIMER " to select a suitable full-automatic program



After switching on, the "Standard" program will be the default. If other full-automatic program is desired, you can press the button " PROGRAM / SET TIMER " to get the corresponding indicator on. Refer to the "Button of "PROGRAM/SET TIMER " " paragraph on page 10.

Page 10

Example: Use the "Quick" program for slightly soiled articles.

- When "standard" program is selected, the washing machine will perform full-automatically controlled fuzzy program to set water level, water flow and wash duration according to the cloth nature and weight
- If there is water inside the tub, the machine cannot detect the laundries and will display middle level. If wet laundries are put in, it may display high level. You must set suitable water level by yourself.

Attention

- Even there's no water in the tub, the spinning will start after a certain period.
- Do not use soak process for woolen laundries.
- Wash the laundries that are prone to lose colors separately from other laundries.
- The pulsator will not rotate unless the water is filled to selected water level.

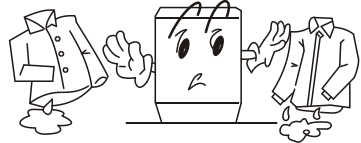

Selection method of the procedure programs

Times of pushing the "select" button	Selected program	Applicable procedure	Contents (the nixie tube indicates the programs about to run)
0	STANDARD	Normal wash	Wash (bb) Rinse(cc) Spin(dd)
1	HEAVY	Large, thick or heavily soiled laundry	Soak (AA) Wash (bb) Rinse (CC) Spin (dd)
2	DELICATE	The laundry needn't spin to avoid wrinkles	Wash (bb) Rinse(cc) Spin(dd)
3	QUICK WASH	For load below 1 kg	Wash (bb) Rinse(cc) Spin(dd)
4	WASH	Repeat using the washing liquid	Wash (bb)
5	SPIN	When the laundries need only spinning after manual washing (first drain then spin)	Spin(dd)

- If you push the "PROGRAM/SET TIMER" button for 6 times, it will resume the original mode, and it will circulate like that.
- If you select the "QUICK WASH" program, you have to set the full procedure of wash, rinse and spin. The procedure can not be selected.

3 Press the "WATER LEVEL" button to select suitable water level



After switching on the power, press the button "WATER LEVEL" to select a water level according to the load. Please refer to the button "Water level" on page 10.

Page 10



4 Push the "PROGRAM/SET TIMER" button to select suitable reserve program



After switching on, the washing machine reserved wash program will be automatically set inactive. If you desire a wash cycle to end at a reserved time, you can press the "PROGRAM/SET TIMER" button over 2 seconds to set a reserved wash program. Refer to The button of "PROGRAM/SET TIMER" on page 10.

- Confirm the reserve program
- When "Reservation" becomes active, the nixie tube displays the time to the end of the reserved wash cycle, and the indicator turns on. During reserve procedure, push the "Reservation" button to display the reserve mode.
- To change the running program or cancel the reservation, you should cut off the supply and reselect.

Page 10



the washing will finish about 18 hours later

5 Press the "start/pause" button



Close the top lid

Except water filling, washing, rinsing and draining, if the top cover is opened, the washing machine will stop running and alarm.

Finish washing

The washing machine cuts off the power supply automatically when wash cycle ends.

Disposal after washing

- After using, please clean the lint and foreign materials of the lint filter etc. in time. Otherwise it may influence your using the machine.
- Please first pull off the power plug from the receptacle before cleaning.

- When washing, lint filter must be used
- After using, please clean it in time.

Lint filter:

1.Pull upward to detach

2.Clean the lint

Put it in water and clean while it is still wet.
(See to Figure 1).

3.Press downward to assemble.



Clean Figure 1

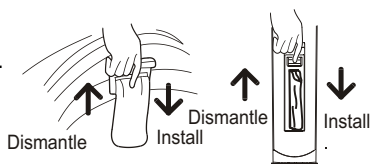
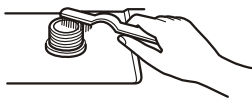

Figure 2

The filter screen of the water inlet valve is likely to be blocked by foreign materials and influence the water inlet. Please clean it



If the cabinet is dirty, wipe it with wet cloth

- Do not flush it directly with water.
- Wipe it with neutral detergent.
- Do not wipe it with thinner, petrol, alcohol etc.

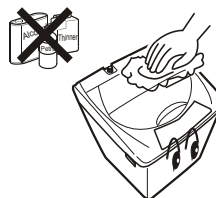

- 1.After washing, close the water faucet. (If needed, you can dismantle the water inlet hose).
- 2.Do not store water in the washing machine for a long period. Drain the water completely after each using.
- 3.Be sure to pull off the power plug before maintenance.
- 4.Hang up the power cord and drain hose.
- 5.Wipe off the water drops on the surface of the machine and inside the tub. Open the top lid for some time (about 1 hour), then close the top lid.

Trouble shooting • Answer to question





(If there's breakdown, please pull off the power plug before checking) The following phenomena are not breakdowns sometimes. Please confirm again before sending it to repair. If there are real breakdowns, please come to the special maintenance department or after-sale service department of our company. Do not repair it by yourself.

Phenomena		The reason	How to settle
Buzzing upon reservation starts, Nixie tube indicates "E0"		<ul style="list-style-type: none"> ● The top lid is not closed 	<ul style="list-style-type: none"> ● Close the top lid
No or slow drain, nixie tube indicates "E1", buzzing.		<ul style="list-style-type: none"> ● Is the drain hose put down? ● Is the drain hose blocked by foreign material? 	<ul style="list-style-type: none"> ● Put down the drain hose. Open and close the top lid once. ● Clean the foreign material. Open and close the top lid once.
Running pauses during spin, nixie tube indicates "E2", buzzing		<ul style="list-style-type: none"> ● The top cover leaves open 	<ul style="list-style-type: none"> ● Close the top lid
Safety switch actuates, not spin, (after self-correction twice), nixie tube displays "E3", buzzing		<ul style="list-style-type: none"> ● Are the laundries put slantingly? ● Is the machine slanting? 	<ul style="list-style-type: none"> ● Re-order the laundries. Close the top lid. ● Level the machine in right position. Open and close the top lid once.
No or slow water filling (not reaching the level in 15min), nixie tube indicates "E4", buzzing		<ul style="list-style-type: none"> ● The water tap is not open ● The water inlet valve is blocked ● The water pressure is too low and the current is too small 	<ul style="list-style-type: none"> ● Open the water tap. Push the "Start/Pause" button. ● Clean the water inlet valve. push the "Start/Pause" button. ● Wait for the normal water pressure before use.
Poor or no waterfall flow		<ul style="list-style-type: none"> ● If the nozzle is choked with foreign bodies 	<ul style="list-style-type: none"> ● Remove the foreign bodies
The machine does not act	Not wash	<ul style="list-style-type: none"> ● Is there power failure? ● Is the power plug loose? ● Does the water level arrive at the set water level? 	<ul style="list-style-type: none"> ● Use it when the power is on. ● Insert the power plug tightly. ● Affusion to the set water level.
	Not spin	<ul style="list-style-type: none"> ● Is the power plug loose? ● Is the top lid closed? ● Are the laundries put orderly? 	<ul style="list-style-type: none"> ● Insert the power plug tightly. ● Close the top lid ● Put the laundries orderly.
There's abnormal sound inside the machine		<ul style="list-style-type: none"> ● Is the machine slanting? ● Are the laundries slanting in spinning? 	<ul style="list-style-type: none"> ● Level the machine properly. ● Re-order the laundries.
The water faucet leaks		<ul style="list-style-type: none"> ● Is the jointer screw of the water inlet hose is loose or twisted awry? 	<ul style="list-style-type: none"> ● Fasten the jointer screw properly.

Common phenomena

Phenomena	Explanation
<ul style="list-style-type: none"> ● The spinning is intermittent when it starts. 	<ul style="list-style-type: none"> ● Balance the laundries to avoid slanting.
<ul style="list-style-type: none"> ● Push the "Process" button to select "Spin", but it doesn't work. 	<ul style="list-style-type: none"> ● The program is setting the drain time. Some time is needed before it starts spinning.
<ul style="list-style-type: none"> ● There may be some water flowing out of the drain hose in the first use of the machine. 	<ul style="list-style-type: none"> ● It is the water remained in the factory inspection of performance.
<ul style="list-style-type: none"> ● While water filling in wash and rinse, the pulsator pauses rotation 	<ul style="list-style-type: none"> ● To prevent splash during water filling.
<ul style="list-style-type: none"> ● Wash pauses 	<ul style="list-style-type: none"> ● Supplementary water filling 48 s after sensor tests cloth material.

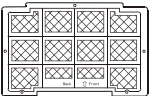
Packing list

Name	Quantity
<ul style="list-style-type: none"> User's manual 	<ul style="list-style-type: none"> One piece
<ul style="list-style-type: none"> Components of the water inlet hose 	<ul style="list-style-type: none"> One piece
<ul style="list-style-type: none"> Lint filter 	<ul style="list-style-type: none"> Two piece
<ul style="list-style-type: none"> Bottom plate 	<ul style="list-style-type: none"> One piece
<ul style="list-style-type: none"> Tapping screws 	<ul style="list-style-type: none"> Five pieces
<ul style="list-style-type: none"> Fully automatic washing machine 	<ul style="list-style-type: none"> One set

Specification

Water level/Water quantity (about)	High/About 48 L、MIDDLE/About 37L、 Low/About 30L、EX.LOW/About 20L
Water inlet pressure	0.03MPa-1MPa
Rated washing/spinning capacity(kg)	6.0/6.0

Free Manuals Download Website

<http://myh66.com>

<http://usermanuals.us>

<http://www.somanuals.com>

<http://www.4manuals.cc>

<http://www.manual-lib.com>

<http://www.404manual.com>

<http://www.luxmanual.com>

<http://aubethermostatmanual.com>

Golf course search by state

<http://golfingnear.com>

Email search by domain

<http://emailbydomain.com>

Auto manuals search

<http://auto.somanuals.com>

TV manuals search

<http://tv.somanuals.com>