

Haier

Automatic Drum Washing Machine

HKS1200TXVE/ME

HKS1000TXVE/ME

HKS800TXVE/ME

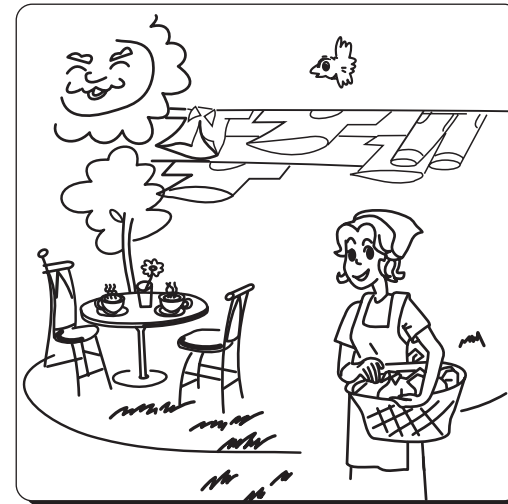

Table of Contents

Before using the appliance

- Name of parts...inside front cover
- Matters needing attention.....1-3
- Installation.....4-5
- Function6-7

How to operate the wasing machine



- Program description table.....8
- Preparation9
- Washing Procedure10-11

Maintenance

- Maintenance12
- Troubleshooting Guide13
- Technical Specifications14
- Wiring Circuit15

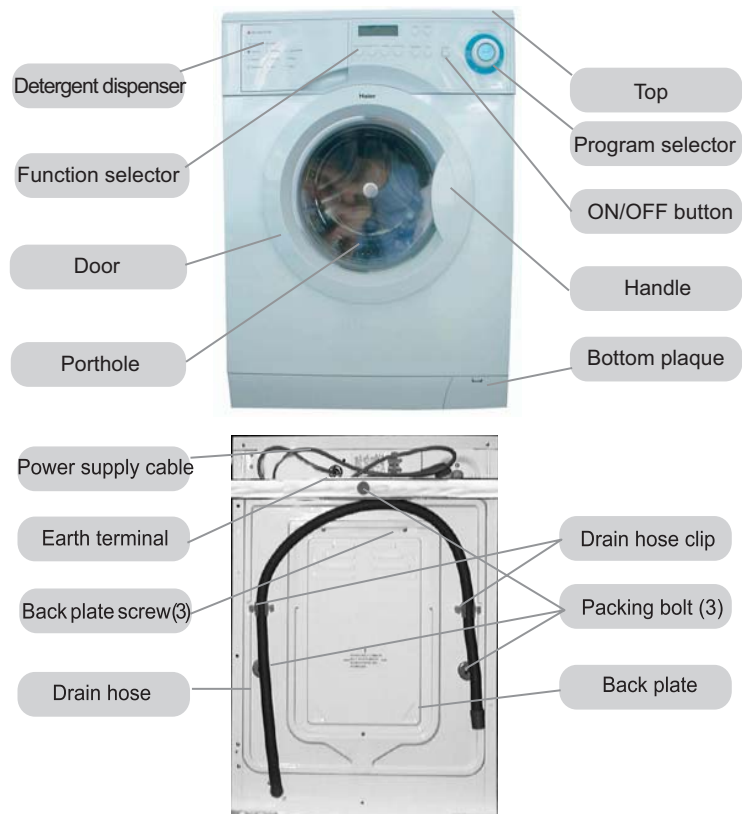
Name of Parts



Caution and Warning symbols	
	<p>For you safely,any instructions in this manual with this "Warning"sign must be followed strictly.</p>
	<p>For your safety and to prevent damage to the washing machine,any instructions in this manual with this "Stop" sign must be followed strictly.</p>

This diagram may be slightly different from the layout of the washing machine you have just purchased due to technical improvements

Matters Needing Attention

● Safety

1. A separate earthed socket is required for the power supply. The washing machine must be positioned so that the plug is accessible.

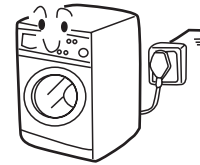

2. Hold the plug and not the electric cable when unplugging the washing machine.

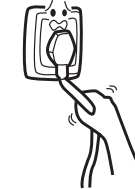

3. Fuses in the power circuit should be rated for 15A. If the supply cord is damaged, it must be replaced by the manufacturer, its service agent or similarly qualified persons in order to avoid a hazard.

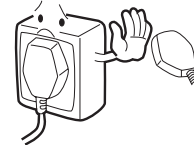

4. Do not touch or use the washing machine barefooted or when the hands or feet are wet.



5. Do not use flammable detergent or dry cleaning agent; do not use flammable spray in close vicinity to the washing machine; do not remove or insert the plug in the presence of flammable gas.



6. The door of the washing machine will become hot during the heating process. Avoid contact with the door during the heating process. For safety, keep children away from the washing machine.



7. Keep children away from the packing materials after unpacked.

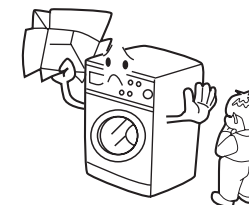

Wiring Circuit

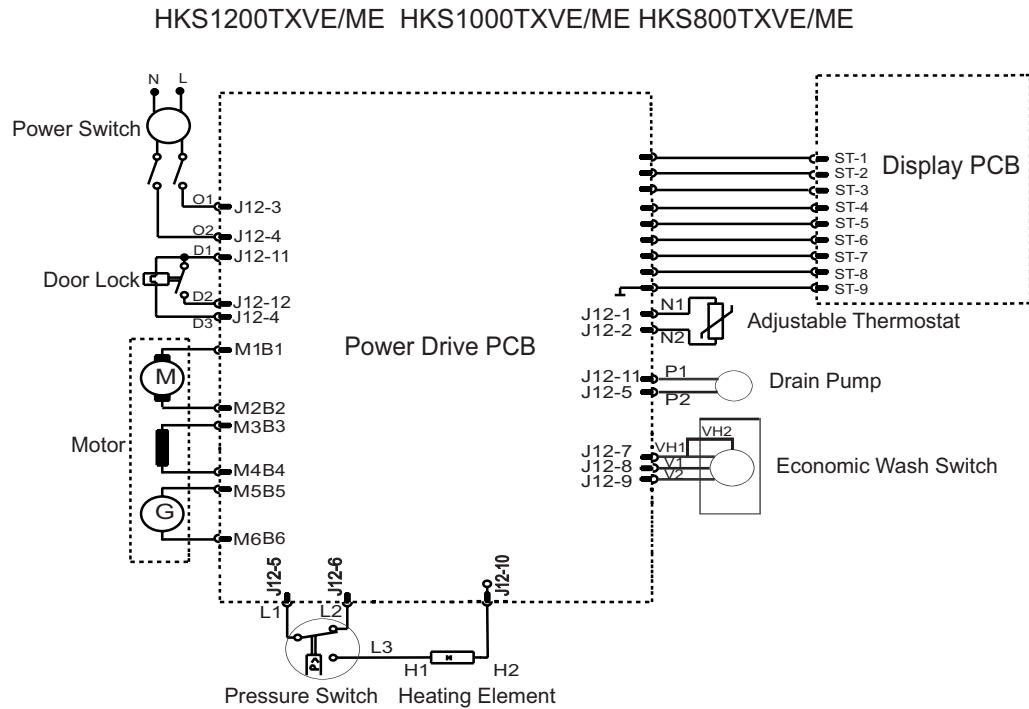

Matters Needing Attention

8. The washing machine should not be installed outdoors or in a damp place. In the event of water leakage or splashes allow the machine to dry naturally.

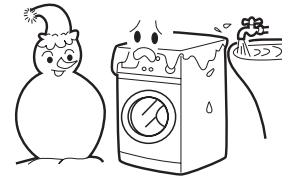

9. The carpet must not obstruct the ventilation openings in the base of the washing machine.

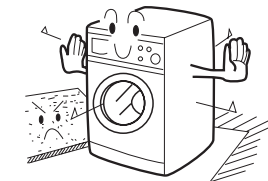

10. Keep away from heat sources and direct sunlight to prevent plastic and rubber components from aging.



11. During installation, ensure that the electric cable is not trapped by the washing machine and avoid damage to the electric cable. Dear customer, For the machine and your own security, DO NOT REPAIR IT BY YOURSELF! DO NOT USE THE WASHING MACHINE WHICH SOME PARTS ARE LOST!

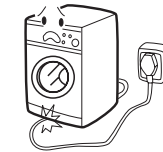

During Use





1. Before use, check the joints of the filling hose, the tap and the drainage hose for possible problems from water pressure fluctuations. If joints are loose or there is leakage, turn off the tap and repair. Do not use the washing machine until the hoses are properly fixed.



2. Keep the door slightly open when the washing machine is not in use to prevent formation of odors; do not cover the washing machine with plastic cover so that inside dampness cannot be kept in.

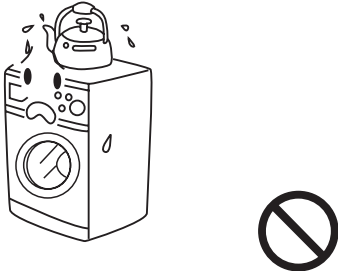

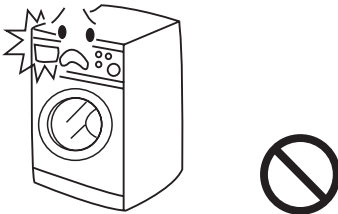
Matters Needing Attention

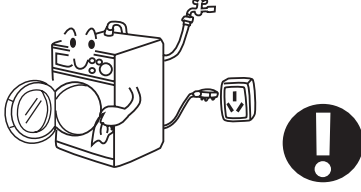
<p>3. Do not place heavy, heating source or wet articles on the top of the washing machine.</p> 	<p>4. Do not hot wash foam rubber or sponge-like materials.</p> 
<p>5. Before washing, do up zippers, buttons and clothes straps and put small articles, such as socks, laces or bras, into a washing bag or a pillow.</p> <p>Steel wires in bras will pop out during washing; never wash bras containing steel wires.</p> 	<p>6. Do not open the detergent distribution drawer during the wash cycle.</p> 
<p>7. The door is fitted with a self-lock device and will not open until 2~3 minutes after the washing machine stops. Do not force the door open. Do not open the door if water level can reach the porthole.</p> 	<p>8. After each wash program, turn off the tap to prevent leakage; and unplug the washing machine and wipe clean the lower part of the porthole.</p> 

Technical Specifications

Model	HKS1200TXVE/ME	HKS1000TXVE/ME	HKS800TXVE/ME
Power supply	220V~(50Hz)	220V~(50Hz)	220V~(50Hz)
Power(Max)	2100	2100	2100
Water pressure (MPa)	0.05 ≤ P ≤ 1	0.05 ≤ P ≤ 1	0.05 ≤ P ≤ 1
Washing power(W)	160	160	160
Spinning power(W)	450	450	450
Max. wash load (kg)	5	5	5
Spinning speed (MAX) (r/min)	1200	1000	800
Wash program	9	9	9
Heating power (W)	1900	1900	1900
Weight (kg)	74	74	74
Anti-Electric Shock	I	I	I
Anti-Water Class	IPX4	IPX4	IPX4

Troubleshooting

The following circumstances do not constitute problems. Do not contact the maintenance service until the problem has been confirmed.

Problem	Possible cause
The washing machine fails to operate	<ul style="list-style-type: none"> ● Poor connection to power supply ● Power failure ● Door is not properly closed (It will show E1) ● Machine has not been switched on
Washing machine cannot be filled with water	<ul style="list-style-type: none"> ● Water tap is not turned on (It will show E5) ● Water pressure is less than 0.05Mpa ● The inlet hose is kinked ● Water supply failure ● The program dial is not properly set ● The door is not properly closed ● The inlet hose filter is blocked
The machine is draining while is being filled	<ul style="list-style-type: none"> ● The height of the drainage hose is below 80cm (it should be within 80-100cm) ● The drainage hose end is in water
Drainage failure	<ul style="list-style-type: none"> ● Drainage hose is blocked (It will show E2) ● Drainage hose end is exceed 100cm above the floor level ● The filter is blocked
Strong vibration during spin drying	<ul style="list-style-type: none"> ● Not all packing bolts have been removed ● Washing machine is located on an uneven surface ● Machine load is over 5kg. ● Not all foam packing has been removed from the motor
Operation stops before completion of a wash cycle	<ul style="list-style-type: none"> ● Water or electricity failure ● Washing machine is in soak cycle
Operation stops for a period of time	<ul style="list-style-type: none"> ● Washing machine is in soak cycle ● Washing machine gives an error message.
Excessive foam in the drum, which is spilled to the distribution drawer	<ul style="list-style-type: none"> ● The detergent is not a low-foaming type or for manual wash ● Excessive use of detergent

Installation

- Remove all the packing materials (including the foam base) to prevent vibration during use, as shown in Fig.1. Upon opening of the package, water drops may be seen on the plastic bag and the porthole. This is normal phenomenon resulting from water test in the factory.

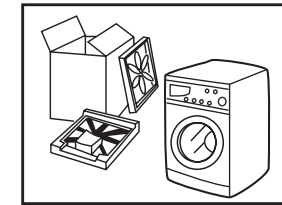

Fig. 1

- Check attachments and materials with reference to the following

Qty	Name	Operation manual	Quality certificate	Water hose	Drainage holder	Plastic plugs
	Model					
	HKS1200TXVE/ME	1	1	1	1	3
	HKS1000TXVE/ME					
	HKS800TXVE/ME					

- Dismantle the packing bolts as shown in Fig. 2.

The packing bolts are designed for clamping anti-vibration components inside of the washing machine during the transportation process.

Before use:

1. Remove the back plate;
2. Remove the three packing bolts on the back plate and take out the rubber hose;
3. Replace the back plate;
4. Fill the holes left by the packing bolts with plastic plugs.

(Attention: The packing bolts and rubber hose should be kept in a safe place for later use)

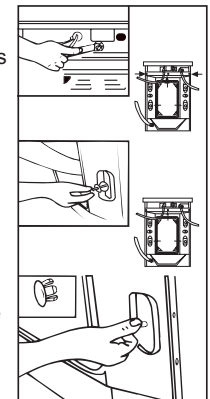

Fig.2

- Adjusting the washing machine

There are adjustable feet under the bottom of the washing machine. Before use, the washing machine should be adjusted, as shown in Fig. 3, so that it is level.

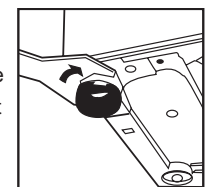
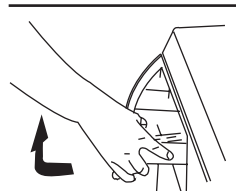
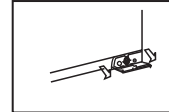
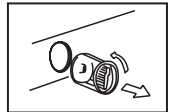
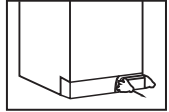

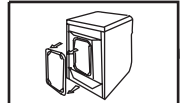
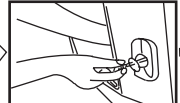
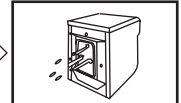



Fig.3

Maintenance

<p>1. Turn of the water and electricity supply after every wash. Open the door to prevent the formation of moisture and odors. If the washing machine is left idle for a long period, drain any remaining water in the machine and replace the drainage hose.</p>	<p>2. Unplug the machine during cleaning and maintenance. Use a soft cloth dampened with soapy Liquid to clean the machine case and rubber components. Do not use corrosive or abrasive chemicals or solvents.</p>
<p>3. Clean the detergent compartment regularly. For the detergent compartment similar to figure (a), raise the compartment slightly to remove and replace after cleaning.</p>  <p>Fig.(a)</p>	<p>4. Clean the filter Cleaning methods (once a month)</p> <ol style="list-style-type: none"> 1) Push out the outer cover (Fig. 1); 2) Screw out filter by turning counterclockwise (Fig. 2); 3) Flash clean with running water; 4) Replace the filter by turning clockwise and remount the cover. <p>Caution: The filter must be in place, or it may lead to leakage.</p>    <p>Fig1 Fig2 Fig3</p>
<p>5. To prevent blockages to the water supply or the ingress of contaminants, clean the water inlet and inlet water filter regularly.</p> 	<p>6. If the machine is to be moved a distance location, replace the vibration mounting locks which were removed during installation as shown below.</p>  <p>Remove the back cover.</p>  <p>Remove the rubber plugs.</p>  <p>Insert the bolts.</p>  <p>Tighten the bolts with the spanner provided.</p>  <p>Replace the rear panel.</p>
<p>7. If the washing machine is left idle for a long period turn off the water and electricity supply and open the door slightly to prevent the formation of moisture and odors.</p>	

Installation

Connection of water inlet hose and washing machine

1. Place the water inlet hose nut on the connector of the water inlet valve.

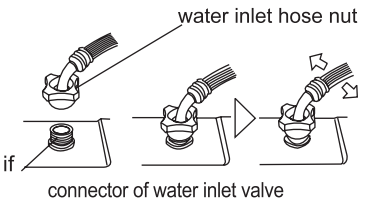

2. slightly shake the water inlet hose nut to see if it is tightly and properly fixed.

Water drainage hose

- The height of the terminal of the water drainage hose should be between 80cm-100cm, the water drainage hose must be securely placed on the clip on the back of the washing machine.

- Use the water drainage support supplied as an accessory for proper installation of the water drainage hose. Fix the water drainage hose support with waterproof string. Do not use an excessively long water drainage hose and contract the authorized technician if the water drainage hose needs to be extended. The water drainage hose should not be extended more than 250cm. (longer extension will result in concurrent water inflow and outflow). The diameter of the extension hose should be the same as the original hose.

caution: water drainage hose must not be immersed in water. the original and extension hoses should be tightly connected.

- The appliance is to be connected to the water mains using new hose-sets and that old hose-sets should not be reused.

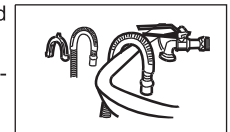
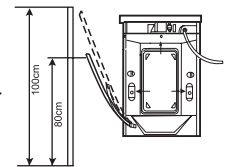

Connection of power supply

Check the following items before connection to the power supply.

- The socket conforms to the maximum power load (The maximum current load of the socket and power supply cable should not be less than 15A).

- power supply voltage conforms to the required value.

- The power supply socket and the plug of the washing machine should be compatible. if they are not compatible, Refer to a washing machine technician or a Haier designated service point for power cable replacement. The washing machine should be connected to the earth before use.

- Supplementary earth cable should not be necessary if the socket is connected to the earth.

- Supplementary earth cable should be installed on the upper back of the washing machine and connected to an earth if the power supply socket has no earth connection.

Caution: the supplementary earth cable should not be connected to water or heating pipes.

Operational Functions

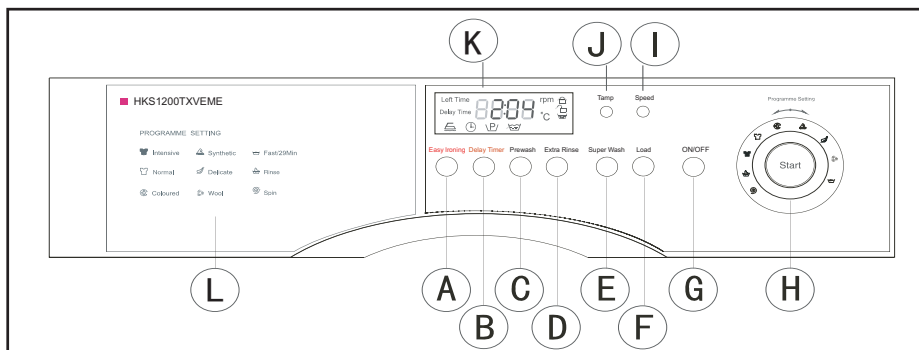

A: Ironing-free button

Press this button, the laundry will be fluffed up at the end of the spinning cycle to reduce wrinkles.

B: Delay button

Press the Delay button before the program is started if necessary. Press of the Delay button one time, the delay time will increase one hour (the regulating range is from the current setting to 24 hours). After the delay time is changed, press the Start button to activate the delay function.

Note: The delay time must be longer than the program time; otherwise, the washing machine will start the wash program directly.

C: Pre-wash button

Press this button, the washing machine will automatically start a prewash cycle during execution of a washing program.

D: Extra rinsing button

Press this button, the washing machine will run an additional rinsing cycle to further clean your clothes.

E: Super wash button

Press this button, the display will be on when choosing super wash button. The "SUPER" and "NO SUPER" will display circularly. The sign of super wash will be off when the super wash system finished.

F: Washing load button

Press this button, 3 load levels of "—" (0-1.5kg), "==" (1.5-3kg) and "≡≡≡≡" (3-5kg) will appear on the screen for manual selection before water is filled. After the load is set, the water content will be automatically adjusted.

G: Power button

Press this button to switch on the washing machine; press it again to switch the machine off. To cancel a wash program during a wash cycle, please switch the machine off.

Hints for Saving Energy

4. Setting washing temperature

Press the temperature button until " _ _ °C" is displayed if heating is not needed; otherwise, select an appropriate temperature as required (refer to the "Guide to Operational Program Selection").

5. Function selecting button

Select functions as required (refer to the "Operational Functions" section).

6. Washing

Press the Start / Pause button, the indicator at the upper left corner of the button will blink and the washing machine starts operation.

7. Finish

The washing machine will stop operation automatically when a wash cycle ends. The "End" sign will appear. Open the door and take out the laundry. Then turn off the tap and unplug the power cable.

● Hints for saving energy

During operation

1. Collect clothes for one full wash load.
2. Do not overload the washing machine.
3. Pre-wash heavily soiled clothes.
4. Reduce the amount of detergent or choose standard or delicate wash programs for slightly soiled clothes.
5. Choose a proper washing temperature. Only exceed 60°C for heavily soiled clothes.
6. Do not use more detergent than required.
7. Softening agent makes clothes feel softer and easier to iron.

Washing Procedure

1. Loading

Open the door, put in the laundry piece by piece. Close the door tightly.

Notes: 1) When first using the washing machine, let it run unloaded for one program to prevent the laundry from being tainted by oil or dirty water from the washing machine.
2) Do not overload the washing machine.



Load Reference

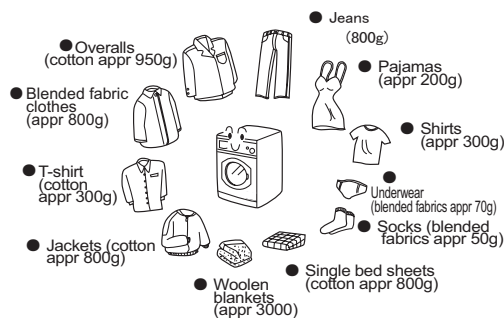

2. Adding detergent

Slide out the detergent drawer and put the required detergent and softening agent into the corresponding boxes. Push back the drawer gently.

Caution:

- 1) For pre-washing program, detergent should be added to both compartments 1 and 2. Compartment 2 allows only solid detergents. For other programs, do not add detergent to compartment 1.
- 2) Do not overuse softener; otherwise, it will damage the artificial fibers. Refer to the instructions during use.

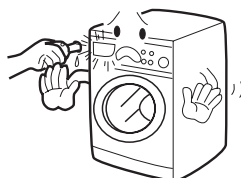

3. Selecting washing program

To get the best washing effect, an appropriate washing program should be selected according to the laundry type.

Note: The above operations refer to conditions without power-off memory. Or the washing machine will continue operation from where the program was broken. To clear memory, press the Start/Pause button. Turn off the power for a few seconds and turn on again, all the settings will be renewed.

Functions

H: Wash programming knob and start button

By turning the knob clockwise or counterclockwise, the required program can be selected; press the start button to start a program; press it again to pause

I: Speed button

Press this button to set a required spinning speed, which covers 0 rpm to 1200 rpm. (0-1200rpm for HKS1200TXVE/ME 0-1000rpm for HKS1000TXVE/ME 0-800rpm for HKS800TXVE/ME)

J : Temperature button

Press this button to set a required temperature. The selectable temperature range is 0-90°C. (Some programs have temperature limits. Refer to the programming guide)

K: Display

Remaining time, set temperature, spinning speed, other function information, and error messages are displayed. Refer to the Display Description

L : Detergent distribution drawer

There are instructions on the handle of the distribution drawer. Swing out the drawer, three compartments can be seen.

Compartment 1: Pre-washing detergent. If pre-wash is not selected, do not add detergent.

Compartment 2: Detergent for all washing programs. Detergent must be added whether pre-wash is selected or not.

Compartment 3: Softening agent, conditioning agent, perfume, etc

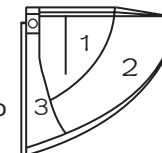









B+C: combination for keyboard lock

After a program is started, press the delay button and the Pre-wash button at the same time for 3 seconds, the keyboard will be locked and "SAFE ON" will appear on the screen. Press the two buttons again for 3 seconds, the keyboard will be unlocked and "SAFE OFF" will be displayed. This function is used to protect the washing machine from being disturbed during operation, such as accidental press of buttons or turning of knobs by children, as this may affect or suspend the operation of a program. Note: If this function is activated during a washing cycle, be sure to inactivate it at the end of the cycle when the "End" sign is displayed.

Caution: If the keyboard lock is not activated, press the Start/Pause button and then cut off the power, the suspended program will be canceled after power is resumed. Now turn the program knob to reselect.

Program Description Table

Mode Selection		Recommended Laundry	Selectable Temperature	Program Time (At Max Temperature)	Detergent			
Button Position	Program				1	2	3	
Cotton		Intense	Heavy and thick fabrics	0-90°C	2:26	●	★	0
		Normal	White fabrics	0-90°C	1:41	●	★	0
		Delicate	Fast-color and medium soil fabrics	0-60°C	1:25	●	★	0
Synthetic		Normal wash	Fast-color and heavy-soil fabrics	0-60°C	0:58	●	★	0
Delicate /Super Quick Wash		Cashmere	Wool and silk	0-40°C	0:49	x	★	0
		Wool	Wool	0-40°C	0:46	x	★	x
		Super quick wash	Medium-soil cotton & synthetics	0-40°C	0:29	x	★	x
Single Wash Program		Rinse		/	0:32	x	x	0
		Spin dry		/	0:11	x	x	x

Note : " 0 " indicates that softener or bleacher can be added if needed;

" ★ " indicates that detergent must be added;

" X " indicates that detergent must not be added.

" ● " indicates that if pre-wash is selected,detergent must be added.

Preparation

1.Power supply

Plug in the power supply 220V~50HZ



2.Water supply

Turn on the tap ensure that the water in clear.

Caution:Before starting the washing machine turn on the water faucet to ensure the water faucet and the water inlet hose are connected correctly and do not leak



4.Detergent selection

Only special low foam detergent should be used in automatic drum washing mashine,form blended or wool fabrics special deter-gent should ne used.dry cleaning solvent should not be used such as trichhloroethy-lene or alike (caution :load the required amount of detergent only).

3.Laundry treatment

● Sort out clothes according to type and extent of dirt.There are three types of clothes:cotton,synthetical and woolen (silk) fabrics.

● Separate white clothes from colored.If whites and coloreds are combined for one load,make sure the coloreds are colorfast



-Clothing with frayed edges or yams should be put in a wash bag or special bag before washing

-repair damged clothing,lose buttons or damaged zips and hooks before washing.

-Bed sheets and table ware should be loosely loaded and not folded.

● This washing mashine is for household use and designed for mechanically washable clothes.When washing,separate unwashable clothes with reference to clothes labels.

5.Wash Load

Type	non-fade cottens	Delicate fabrics	Woolen fabrics
Max Load	5kg	3kg	2kg

Free Manuals Download Website

<http://myh66.com>

<http://usermanuals.us>

<http://www.somanuals.com>

<http://www.4manuals.cc>

<http://www.manual-lib.com>

<http://www.404manual.com>

<http://www.luxmanual.com>

<http://aubethermostatmanual.com>

Golf course search by state

<http://golfingnear.com>

Email search by domain

<http://emailbydomain.com>

Auto manuals search

<http://auto.somanuals.com>

TV manuals search

<http://tv.somanuals.com>