

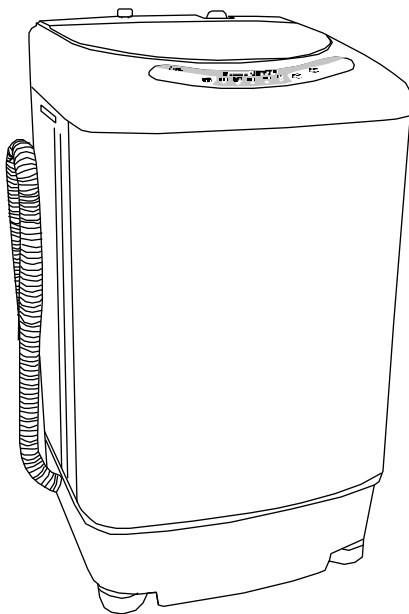

Portable
Electronic Washer



Lave-Linge
Électronique Mobile

Lavarropas
Eléctrico portátil

User Manual-

Model #

Guide de l'Utilisateur- Modèle #

Manual del Usuario- Modelo #

HLP21E

English

IMPORTANT SAFETY INSTRUCTIONS

Warning – To reduce the risk of fire, electric shock, or injury to persons when using your appliance, follow basic precautions, including the following:

1. **Read all instructions before using the appliance.**
2. Use this appliance only for its intended purpose as described in this use and care guide.
3. Use only detergents or softeners as recommended for use in this manual and keep them out of the reach of children.
4. This appliance must be properly installed in accordance with the installation instructions before it is used.
5. Never unplug your appliance by pulling on the power cord. Always grasp the plug firmly and pull straight out from the outlet.
6. Replace immediately any worn power cords, loose plugs and power outlets.
7. Unplug your appliance before cleaning or before making any repairs.
8. If your old appliance is not being used, we recommend that you remove the door. This will reduce the possibility of danger to children.
9. Do not operate your appliance in the presence of explosive fumes.
10. Do not use this appliance to wash clothes that have been soaked, spotted or washed in gasoline, dry cleaning solvents or any other explosive or flammable substances that may ignite and explode.
11. Clothes or rags used to clean flammable or explosive materials should not be washed in this appliance until all traces of this material have been removed.
12. Do not add or mix any flammable or explosive substances to the wash.
13. Do not try to remove clothes while the tub is moving. Allow it to come to a complete stop before reaching in.
14. The appliance's loading door must be closed when the tub is spinning.
15. Do not operate your appliance when parts are missing or broken.
16. Do not use this appliance for commercial uses.
17. Do not operate this appliance unless all enclosure panels are properly in place.
18. Do not tamper with controls.
19. To reduce the risk of injury, do not allow children to play in or on the appliance. Close supervision of children is necessary when the appliance is used near children.
20. This appliance must be connected to a proper electrical outlet with the correct electrical supply.

1

21. Proper grounding must be ensured to reduce the risk of shock and fire. DO NOT CUT OR REMOVE THE GROUNDING PLUG. If you do not have a three-prong electric receptacle outlet in the wall, have a certified electrician install the proper receptacle. The wall receptacle MUST be properly grounded.
22. Hydrogen gas may be produced if the water heater has not been used in more than 2 weeks. This may be explosive under certain circumstances. If this is the case turn on all the hot faucets and let the hot water run for a few minutes before using this appliance. This will let the trapped hydrogen escape. Avoid accidents during this process by refraining from turning ON any electrical appliances, smoking, lighting a match/lighter, and using flames.
23. Do not repair or replace any part of the appliance or attempt any servicing unless specifically recommended in the user-repair instructions, which you understand and have the skill to carry out.

Note: If for any reason this product requires service, we strongly recommend that a certified technician perform the service.
24. To reduce the risk of electric shock or fire, do not use extension cords or adapters to connect the unit to an electrical power source.

SAVE THESE INSTRUCTIONS For Future Use

DANGER

Risk of child entrapment. Before throwing away your old appliance, remove the door so that children may not easily become trapped inside.

Thank you for purchasing our Haier product. This easy-to-use manual will guide you in getting the best use of your washer.

Remember to record the model and serial number. They are on a label in back of the washer.

Model number

Serial number

Date of purchase

(Staple your receipt to your manual.) You will need it to obtain warranty service.

English

Table Of Contents

	PAGE
SAFETY INSTRUCTIONS	1-2
PARTS AND FEATURES	4-5
OPERATING YOUR WASHER	6-11
UNPACKING AND ACCESSORIES INVENTORY	12
PROPER LOCATION	13
INSTALLATION INSTRUCTIONS	14-16
UNIT DIMENSIONS	17
ELECTRICAL CONNECTIONS	18
PROPER CARE AND CLEANING	19
TROUBLESHOOTING GUIDE	20-21
WARRANTY	22

OPERATING INSTRUCTIONS

Parts and Features

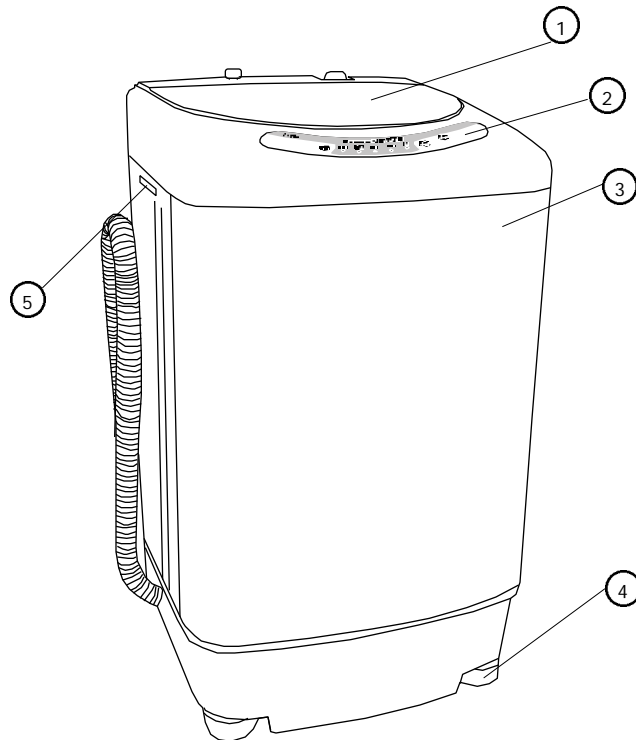

- 1. Top Lid
- 2. Control Panel
- 3. Washer Cabinet

- 4. Front Leveling Leg
- 5. Cabinet Handle (located on both sides of the washer)

English

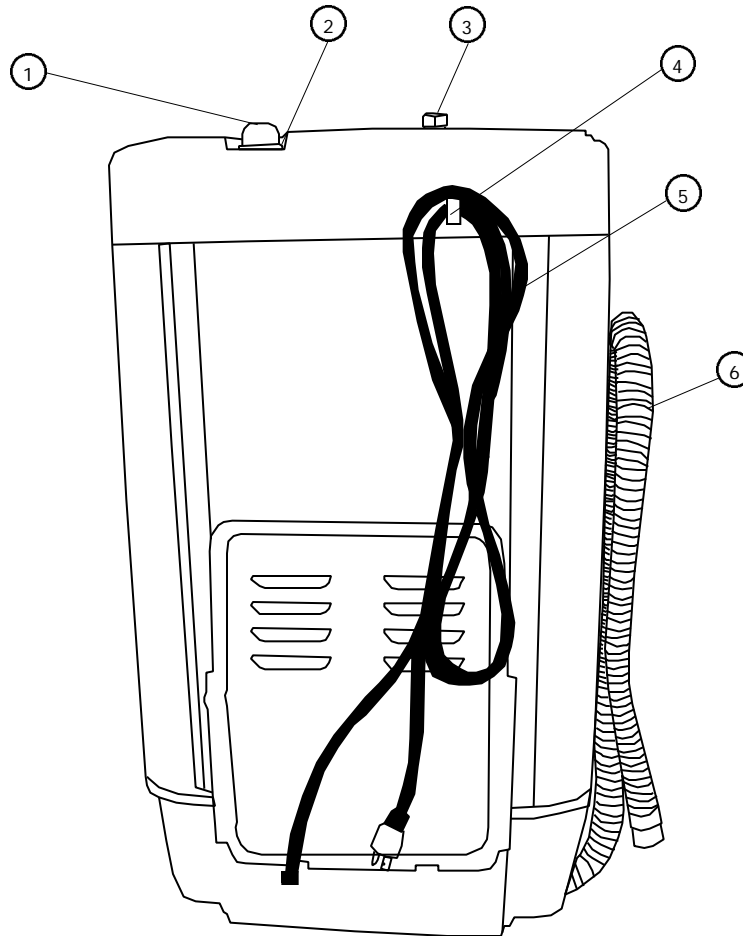

- | | |
|-----------------------------|----------------------------------|
| 1. Water Inlet Valve | 4. Power Cord Holder Clip |
| 2. Water Absorption Cushion | 5. Power Cord (115 Volt / 60 Hz) |
| 3. Water Level Selector | 6. Drain Hose |

OPERATING YOUR WASHER

The Control Panel

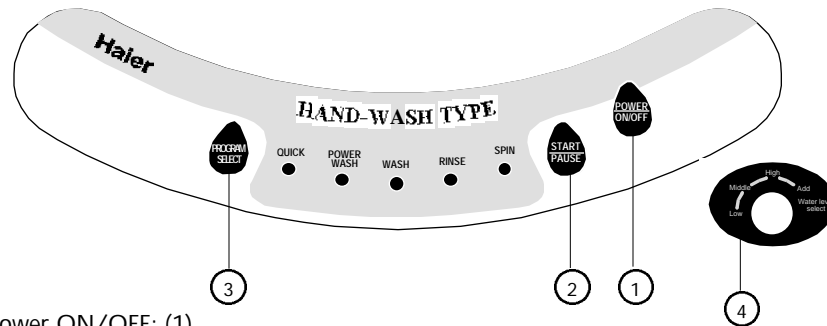

Power ON/OFF: (1)

- Press the button once to turn ON the power to the washer. Press it again to turn the power OFF.

Start/Pause: (2)

- Press this button once to start the wash process. Press this button once again to pause the activity during the wash cycle. Push it again to resume the wash cycle.

Program Select: (3)

- Select your desired cycle program by pressing the "Program Select" button. There are 7 options to select from. Press the Select button for the desired setting.

Water Level Selector: (4)

- Turn the Water Level Selector knob to select the proper water level setting. You may select from low, medium and high water level settings depending on the wash load.

Function Indicator Lights:

- The function display lights indicate that a selected feature is ON or that the cycle is about to begin.
- During the wash cycle, a flashing light indicates the current wash/rinse cycle program.
- Rapid flashing indicates that the washer is not operating properly.

Loading the Washer

- Load each item loosely.
- Separate the white from the colored clothing. Separate heavy fabrics from light fabrics.
- Carefully check all pockets and cuffs for small items. They can easily slide into the tub and cause damage to the tub.

English

- Pre-treat all stains and heavily soiled areas for best results.
- Do not overload your washer.
- Close the door properly after loading the clothes.
- When loading wet items, keep water level high enough to keep the unit in balance and to allow clothing to float easily in the water.

Proper Use of Detergent

- Fill water in the tub at the "Low" water level.
- Add the detergent.
- Load the washer.
- Select the water level.

Note: The amount of detergent used depends on the size of the load, the water type (hard or soft) and whether the clothes are heavily soiled or lightly soiled. Besides the performance of the washing machine, the quality of the detergent also affects the wash result. For best results, use low sudsing detergents only. Refer to the detergent manufacturer's recommended amount for usage.

Proper Use of Bleach

Refer to the bleach manufacturer's chart for the recommended use of liquid bleach. Dilute the bleach and add it to the water before putting clothes into the washtub.

Warning! Be careful not to spill undiluted bleach onto the washer cabinet or onto clothing. It is a strong chemical that may damage your clothes and the finish of the washer if not properly diluted.

Lint Filter and Water Filter

- The Lint filter is located inside the washer drum. A small nylon bag collects lint and residue from clothes during the wash cycle.

Note: Do not wash your clothes without the filter in its compartment inside the tub.

- You must clean the filter after every load for the best results. Push down the tab in the filter to remove. Clean and slide the filter back in place.
- There is also a filter in the water inlet valve. This prevents foreign particles in the water from entering the washer. Clean this at least once a month.

Selecting the Wash Cycle

- Press the "Program Select" button for your desired wash cycle. Choose between 7 options.
- The total time includes the normal water inlet time and drain time. The total washing time may be affected by the water inlet pressure and water level.
- The spin time is the time from the intermittent running to the finishing of the cycle.
- In the "Power Wash" program, the first soak is approximately 20 minutes, pre-wash is approximately 8 minutes. Clothes are soaked again for approximately 5 minutes. The washing, rinsing and spinning will then be completed. The wash time includes the pre-wash time.
- In the "Quick" program select wash, rinse and spin are set automatically. No procedure can be selected after setting.

Note: When you turn the power ON, the machine will set the standard wash program to the wash/rinse/spin position.

Program Select	Wash Program	Application
Power On	Wash, Rinse & Spin	Normal Wash
Press Once	Wash	No Spin or Rinse
Press Twice	Wash & Rinse	No Spin
Press Three Times	Rinse & Spin	No Wash
Press Four Times	Spin	No Wash or Rinse
Press Five Times	Power Wash, Wash, Rinse, Spin	For heavily soiled and very dirty clothes
Press Six Times	Quick, Wash, Rinse, Spin	For a quick speed wash

English

Wash Program	Soak (approx minutes)	Wash (approx minutes)	Rinse Minutes / Times	Spin (approx minutes)	Total Times (approx minutes)
Wash, Rinse & Spin	-	8 - 15	6 / 2	4	35 - 42
Twice Wash, Wash, Rinse & Spin	25	16 - 30	6 / 2	4	68 - 82
Quick, Wash, Rinse & Spin	-	5 - 9	3 / 1	4	21 - 28

Selecting the Water Level

- There are 3 water levels to choose from: Low, Medium and High. Your selection may depend on your wash load.
- Turning the knob to "Reset" will add more water to your wash load. Release and set to desired level after adding water.

Recommended Water Levels

Load Size in lbs	Water Level	Approximate Water used in Gallons
3.3 - 6.6	High	8.72
1.76 - 3.3	Medium	5.81
Less than 1.76	Low	3.70

Note: Incoming hot water must not exceed 122°F/50°C.

End-of-Cycle Signal

The machine will beep at the end of the cycle, indicating that the washing is complete. The "Wash/Rinse/Spin" indicator lights will still be ON. The washer will turn OFF automatically in approximately 10 minutes after the completion of the cycle.

Closing the Top Lid

For safety purposes, the top lid must always be closed during the wash process. If you open the top lid while the wash cycle is in progress, you will observe the following:

- An alarm will sound.
- The tub will not spin while the lid is open.
- If the unit is in wash mode, it will stop running.

Simply close the top lid and press the start/pause button to resume the cycle.

Steps for the Wash Process

1. Turn the power ON by pressing the "ON" button.
2. Press "Program Select" to select the wash program. Refer to page 8 for the selection chart.
3. Select the water level.
4. Add the detergent.
5. Add the wash load.
6. After the washing machine starts, you may change the program by turning OFF the machine and then restarting to make the new selection.

Note: If the washer is turned ON without any water in the tub, it will start to spin after a few minutes. The pulsator will not rotate unless the water is filled to a selected level.

Note: Do not use the "Power Wash" program for woolen clothing.

English

Normal Operating Sounds

The following sounds are normally heard during the operation of the washer:

- Tumbling sounds can be heard as heavy wet clothes in the washer are tossed around continuously.
- Air rushing noise is the result of the washtub spinning at a very high RPM.
- Clicking sounds are caused by the wash and rinse cycles turning ON and OFF.

Unpacking and Accessories Inventory

Unpacking

1. Remove all packing materials. This includes the foam base and all adhesive tape holding the washer accessories inside and outside. Slide out and remove the bottom Styrofoam that is used to protect the washer from shipping damage due to vibrations and shock.
2. Inspect and remove any remaining packing, tape or printed materials before using the washer.

Note: The bottom panel is located between the upper foam protection and box.

Accessories

- a) 1 Bottom Panel
- b) 8 Screws for the Bottom Plate
- c) 1 Water Inlet Hose
- d) 1 Drain Hook (Gooseneck)
- e) 1 Quick Sink Faucet Adapter
- f) 2 Washers
- g) 1 Lint Filter

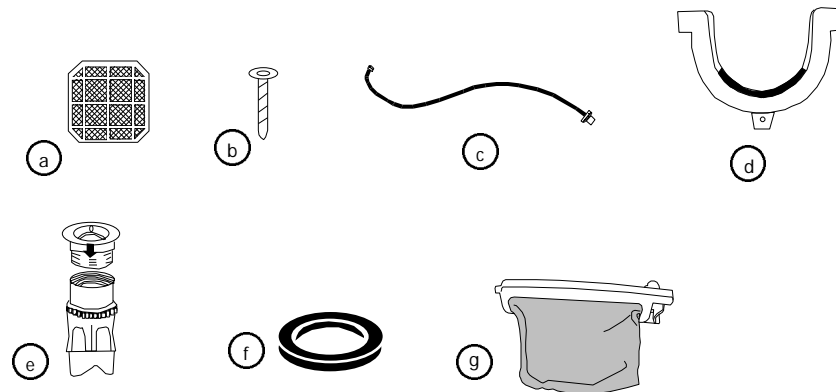

Check to make sure that the accessories are present and in good condition. If you find that they are not in good condition or are missing, please contact our customer service department for assistance. **Our Toll-Free number is 1-877-337-3639.**

English

Proper Location

General

- Select a suitable location for the washer on a hard even surface away from direct sunlight and heat sources (e.g., radiators, baseboard heaters, cooking appliances, etc.).
- Any floor unevenness should be corrected with the leveling leg located on the bottom right corner of the washer.
- The washer must be placed at room temperature. You must not place the washer where the temperature is at or below freezing.

Storage in Cold Environments

- This appliance must be stored at room temperature.
- If you received this appliance when the outside temperature is below freezing, do not operate until this appliance has warmed to room temperature.
- Do not install or operate this appliance in an area where room temperature is below freezing.

Installation Instructions

Read carefully and understand all installation instructions before installing this washing machine. If after completing the process you are still unsure whether the washer has been properly installed, we recommend that you contact a qualified installer.

Tools and Materials Required

You will need to use the following tools when installing your washer:

Scissors
Phillips Screwdriver
Flathead Screwdriver
Pliers
Wrench
Tape Measure
Gloves
Level

Installing the Bottom Panel

The bottom panel blocks noises to provide you with the quietest performance possible during the wash cycle operation.

1. First, lay down the washer on its front side.
2. Place the panel against the bottom of the machine. Align the holes in the panel with the holes in the washer.
3. Insert the screws through the holes of the panel into the bottom of the washer and tighten. (8 screws are supplied)
4. Once all screws have been installed and the panel is in place, return the washer to its standing position.

Note: During this time, you may reroute the drain hose to the left or right side for draining.

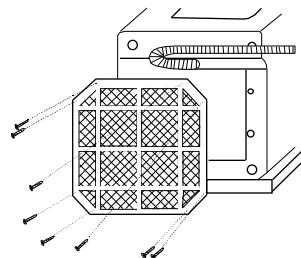

English**Installing the Lint Filter**

The lint filter must be installed before the washer is used.
The lint filter is packaged with the User Manual.

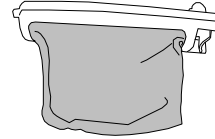
**Leveling the Washer**

Your washer has an adjustable leveling leg that is located on the front right corner. After properly placing your washer in its final location, you may level the washer.

- Loosen the adjustable nut. The leveling leg can be adjusted by turning it counter-clockwise to raise the washer and clockwise to lower the washer.

Note: If the washer is inclined more than 2°, the machine will not operate.

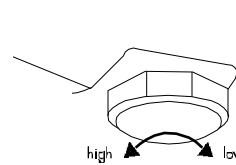
**Installing Your Washer**

Read the installation instructions carefully before beginning.

1. Connect the water inlet hose to the water faucet.

Note: The ends of the inlet hose are marked red and yellow. Red goes to washing machine and yellow goes to the faucet.

2. Connect the other ends to the washer inlet located at the top rear of the machine. Insert a new flat washer (provided) to each end of the inlet hose.

3. The drain hose must be placed into a drainpipe or sink at least 1-1/2 inches in diameter. Use the gooseneck drain hook to hold the hose in place. To avoid possible water back-up, the drain hose must reach a height of at least 31-1/2 inches minimum and 40 inches maximum.

4. Plug in the washer to a regular 115 Volt / 60 Hz, 15 Amps outlet.

Note: Carefully inspect for any leaks around the machine and at the back. If there is a leak, check if any connections are loose. You may need to tighten any loose connections. Do not remove the water absorption cushion. Check before each use to make sure it is not damaged.

CAUTION! If after completing these steps you are still unsure whether unit has been properly installed, contact a qualified installer. We recommend that the washer be installed by a certified technician to ensure that it is properly installed.

Installing Quick Sink Adapter:

When installing the quick sink faucet adapter to the faucet, follow the steps below:

1. First, remove the aerator from your faucet nozzle and determine the size/type of the faucet.
2. Once you determine the size/type of the faucet (Outside Threaded End or Inside Threaded End), place the proper sized rubber washer into the silver faucet adapter.
3. Attach the silver faucet connector to the faucet.
4. Attach the faucet connector to the water inlet hose and make sure that the rubber washer is placed in between.
5. Attach the other end of the water inlet hose to the washer water inlet and make sure that the rubber washer is placed in between.

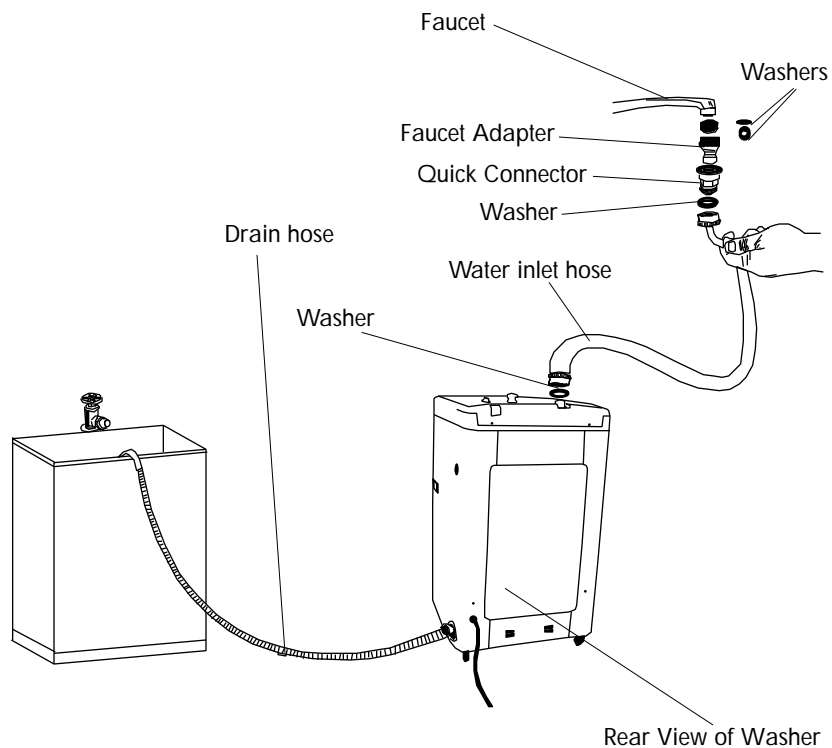

English

Unit Dimensions

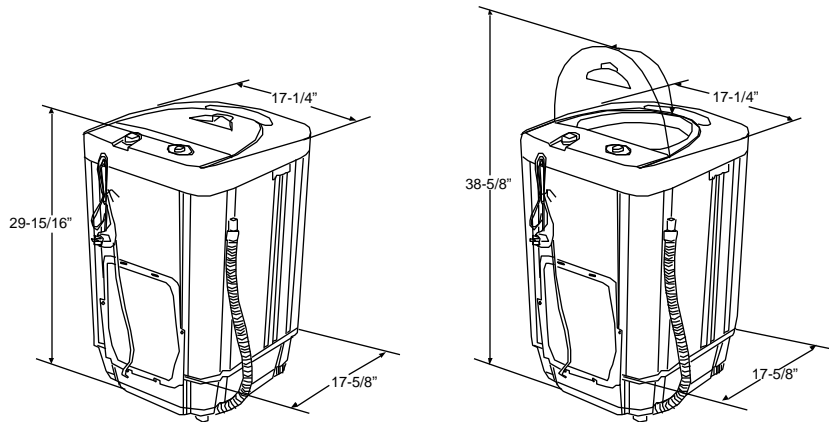

Electrical Connections

Grounding Instructions

This appliance must be grounded. In the event of an electrical short circuit, grounding reduces the risk of electric shock by providing an escape wire for the electrical current. This appliance is equipped with a cord having a grounding wire with a grounded plug. The plug must be inserted into an outlet that is properly installed and grounded.



- Improper use of the plug can result in a risk of electric shock.
- Consult a qualified electrician or service person if the grounding instructions are not completely understood or if in doubt as to whether the appliance is properly grounded.

Wiring Requirements

- This appliance must be plugged into at least a 15 AMP 110-115 VOLT, 60 HZ GROUNDED OUTLET.

Note: Where a standard two-prong outlet is encountered, it is the personal responsibility and obligation of the consumer to have it replaced with a properly grounded three-prong outlet.

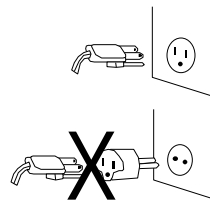

Extension Cords:



We do not recommend that you use an extension cord.

Power Interruptions

Occasionally, there may be power interruptions due to thunderstorms or other causes. Remove the power cord from the AC outlet when a power outage occurs. When power has been restored, re-plug the power cord to AC outlet. If the outage lasts for a prolonged period of time, clean the washer before using it again.

English

Proper Care and Cleaning

Warning! Always unplug your appliance before cleaning to avoid electric shock. Ignoring this warning may result in personal injury or death. Before using cleaning products, always read and follow the cleaning product manufacturer's instructions and warnings to avoid personal injury and product damage.

General Cleaning and Maintenance

Use only a damp or sudsy cloth to clean the control panel.

- To avoid any kind of damage to the cabinet finish, wipe the appliance cabinet as needed. If liquid/powdered softener, bleach or detergent is spilled onto the cabinet, wipe the cabinet immediately because it may cause damage to the finish.
- Do not use any abrasives, harsh chemicals, ammonia, chlorine bleach, concentrated detergent, solvents or metal scouring pads. Some of these chemicals and materials may dissolve, damage and/or discolor your appliance.
- Remove pins and other sharp objects from clothing to prevent scratches on interior parts.
- The lint filter must be cleaned before each use for optimal efficiency. **DO NOT USE YOUR WASHER WITHOUT THE LINT FILTER IN PLACE.**
- The filter screen of the water inlet valve may become blocked by soil and residue. Please clean it with a brush monthly.

Long Absences / Moving

- Turn OFF the water supply faucets and disconnect the hoses. Drain water from all hoses. This will prevent damage from water leakage if the hoses are accidentally ruptured or if they become loose.
- Disconnect the electrical plug.
- Dry the inner washtub. If moving the washer, disconnect the drain hose.
- To prevent mold and mildew, leave the door open so that the moisture inside the machine can evaporate.
- Reinstall the foam base/Styrofoam at the bottom of the unit to prevent internal parts from becoming damaged due to vibrations and shock when the washer is being moved to another location.

Troubleshooting Guide

Before calling for service, determine the symptoms and follow the suggested solutions:

Washer does not operate:

- Check if the unit is plugged in. The plug may have come loose.
- Check if the electrical wall receptacle is of proper voltage.
- Check if the circuit breaker needs to be reset or if the fuse needs to be replaced.
- Check if the washer is overloaded. Reload and redistribute the clothing to rebalance the machine.
- Check if the door is open. You may have to close the door properly.
- Check if the program selections are set properly. You may have to adjust the settings.
- Check the Power "ON/OFF" button to see if it is in the OFF position. You may need to press the button to set it in the ON position.
- Check if the "Start/Pause" button is on "Pause" mode. Press this button to start the wash process.
- The wash process is paused. This is normal. The clothing sensor is checking to verify that there are clothes inside the washtub. Water will be added approximately 48 seconds later.
- The pulsator pauses during incoming water flow in the wash and rinse cycle. This is normal. This prevents splashing during water inlet.
- The washer may need to be reloaded and the clothes may need to be rebalanced.

Problems with water:

- Not enough water is coming in - The water faucet may need to be fully turned ON. Water hose may be tangled or bent. Straighten the hose. Check the water level selection. It may need to be readjusted. This may cause the wash program to pause for a few minutes after water inlet.
- Water leaks - This is due to improper installation of the drain hose or fill hose. Your home drain may be clogged. You may need to tighten the hose, check the plumbing or call a plumber. Water may also leak if the machine is overloaded or if too much detergent is used.
- Water does not drain - This is due to improper installation of the drain hose. You may need to connect the drain hose properly. Check the position of the drain hose. The drain hose may be clogged or bent.
- Water flows out of the drain hose during the first use of the machine - This may be the water left in the tub after the factory inspected the unit to test its performance in order to ensure the best quality.

English**Washer makes noises:**

- Washer may need to be reinstalled and leveled. Refer to the washer installation section.
- Wash load may need to be rebalanced, as the load may be uneven.
- Coins, loose change, buttons or other heavy objects may be making the noise. Refer to the Operating Guide – Normal Operating Sounds.
- A squeaking sound may be due to an overloaded washtub.
- Vibration noises are due to an improper leveling of the washer or an uneven distribution of clothing in the tub.

Problems with clothing:

- Clothes are too wrinkled – Clothes have been improperly sorted or the machine has been overloaded. Do not mix heavy clothes such as work clothes with light clothes such as blouses, light shirts and delicate items.
- Clothes have soap residue – The detergent may not be dissolving in the water. Check the water temperature or add detergent as the washtub is being filled with water (before you load your clothes) to avoid soap residue on clothes. Liquid detergent is recommended.
- Clothes are ripped or have holes - Sharp objects such as pins and belt buckles were left in the washtub. You must remove small, loose, sharp objects. Fasten belts, zippers, metal snaps etc. Check if you are using undiluted bleach. Never add undiluted bleach to the wash.

Other:

- The spinning is intermittent when it starts – The laundry needs to be balanced to avoid slanting.
- The "Spin" does not work in Program Select – The program is setting the drain time. Spinning will start in a few minutes.
- During the final spinning, it stops, the "Rinse" indicator lights up and the washer starts to fill with water – The wash load is slanting on one side. After the water is filled, the slanting will be removed and the spinning will be reactivated.

Limited Warranty

In Home Service

Full ONE Year Warranty

For 12 months from the date of original retail purchase, Haier will repair or replace any part free of charge including labor that fails due to a defect in materials or workmanship.

Limited Warranty

After one year from the original retail purchase date, Haier will provide a part at no cost, as indicated below, to replace said part as a result of a defect in materials or workmanship. Haier is solely responsible for the cost of the part. All other costs such as labor, trip charge, etc are the responsibility of the owner.

Second through Fifth Year

Haier will provide the outer washtub and related outer tub assembly parts should the part fail to hold water.

Second through Seventh Year

Haier will provide the inner stainless steel wash tub if defective in material or workmanship.

Note: This warranty commences on the date the item was purchased and the original purchase receipt must be presented to the authorized service representative before warranty repairs are rendered.

Exceptions: Commercial or Rental Use Warranty

90 days labor from date of original purchase

90 days parts from date of original purchase

No other warranty applies

For Warranty Service

Contact your nearest authorized service center. All service must be performed by a Haier authorized service center. For the name and telephone number of the nearest authorized service center please call 1-877-337-3639.

Before calling please have available the following information:

Model number and serial number of your appliance. The name and address of the dealer you purchased the unit from and the date of purchase.

A clear description of the problem.

A proof of purchase (sales receipt).

This warranty covers appliances within the continental United States, Puerto Rico and Canada. What is not covered by this warranty:

Replacement or repair of household fuses, circuit breakers, wiring or plumbing.

A product whose original serial number has been removed or altered.

Any service charges not specifically identified as normal such as normal service area or hours.

Damage to clothing.

Damage incurred in shipping.

Damage caused by improper installation or maintenance.

Damage from misuse, abuse accident, fire, flood, or acts of nature.

Damage from service other than an authorized Haier dealer or service center.

Damage from incorrect electrical current, voltage or supply.

Damage resulting from any product modification, alteration or adjustment not authorized by Haier.

Adjustment of consumer operated controls as identified in the owner's manual.

Hoses, knobs, lint trays and all attachments, accessories and disposable parts.

Labor, service transportation, and shipping charges for the removal and replacement of defective parts beyond the initial 12-month period.

Damage from other than normal household use.

Any transportation and shipping charges.

THIS LIMITED WARRANTY IS GIVEN IN LIEU OF ALL OTHER WARRANTIES, EXPRESSED OR, INCLUDING THE WARRANTIES OF MERCHANTABILITY AND FITNESS FOR A PARTICULAR PURPOSE

The remedy provided in this warranty is exclusive and is granted in lieu of all other remedies.

This warranty does not cover incidental or consequential damages, so the above limitations may not apply to you. Some states do not allow limitations on how long an implied warranty lasts, so the above limitations may not apply to you.

This warranty gives you specific legal rights, and you may have other rights, which vary, from state to state.

Haier America
New York, NY 10018



IMPORTANT

Do Not Return This Product To The Store

If you have a problem with this product, please contact the "Haier Customer Satisfaction Center" at 1-877-337-3639.

DATED PROOF OF PURCHASE, MODEL # AND SERIAL # REQUIRED FOR WARRANTY SERVICE

IMPORTANT

Ne pas renvoyer cet appareil au magasin.

Si vous avez un problème avec cet appareil, veuillez contacter le service à la clientèle de Haier au 1-877-337-3639.

IL EST OBLIGATOIRE DE FOURNIR UNE PREUVE D'ACHAT DATÉE, LE NUMÉRO DU MODÈLE ET SON NUMÉRO DE SÉRIE AFIN DE BÉNÉFICIER DE LA COUVERTURE DE LA GARANTIE.

IMPORTANTE

No Devuelva Este Producto al Establecimiento Compra.

Si tiene problemas con este producto, por favor póngase en contacto con el "Centro Haier de Atención al Cliente" en el 1-877-337-3639.

PARA EL SERVICIO DE GARANTÍA SE REQUIERE PRUEBA DE COMPRA, FECHADA, No. DE MODELO Y No. DE SERIE

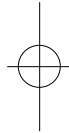
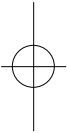

115 V, 60 Hz

Made in China
Fabriqué en Chine
Hecho en China

Haier[®]
■ ● ● ● ● ●
What The World Comes Home To™

Haier America
New York, NY 10018

HLP21E-01
Issued: May-03

Printed in China

Part # WD-9999-14

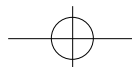

Free Manuals Download Website

<http://myh66.com>

<http://usermanuals.us>

<http://www.somanuals.com>

<http://www.4manuals.cc>

<http://www.manual-lib.com>

<http://www.404manual.com>

<http://www.luxmanual.com>

<http://aubethermostatmanual.com>

Golf course search by state

<http://golfingnear.com>

Email search by domain

<http://emailbydomain.com>

Auto manuals search

<http://auto.somanuals.com>

TV manuals search

<http://tv.somanuals.com>